



US00D770619S

(12) **United States Design Patent**
Genender et al.

(10) **Patent No.:** **US D770,619 S**

(45) **Date of Patent:** **** Nov. 1, 2016**

(54) **SKIN STAPLER**

(71) Applicant: **Medline Industries, Inc.**, Mundelein, IL (US)

(72) Inventors: **Alan Genender**, Northbrook, IL (US);
Yogesh Wadhwa, Vernon Hills, IL (US); **Derek Roberts**, Chicago, IL (US); **Michael Turturro**, Arlington Heights, IL (US)

(73) Assignee: **Medline Industries, Inc.**, Mundelein, IL (US)

(**) Term: **14 Years**

(21) Appl. No.: **29/503,564**

(22) Filed: **Sep. 26, 2014**

(51) **LOC (10) Cl.** **24-02**

(52) **U.S. Cl.**
USPC **D24/145**

(58) **Field of Classification Search**
USPC D24/145, 133, 146-147; D8/49, 68;
227/175.1, 180.1, 901-902; 606/139,
606/142, 143, 170
CPC A61B 17/0684; A61B 17/0401; A61B
17/0469
See application file for complete search history.

(56) **References Cited**

U.S. PATENT DOCUMENTS

4,204,623 A * 5/1980 Green B25C 5/16
227/121
D327,323 S * 6/1992 Hunt D24/145
5,330,087 A * 7/1994 Murray A61B 17/0684
227/175.1

(Continued)

OTHER PUBLICATIONS

“Medline Catalog”, Absorbable GIA Skin Stapler by Covidien; Medline Catalog; <http://www.medline.com/catalog/catalog.jsp>; Unknown Publication date but believed to be prior to present application filing date.

(Continued)

Primary Examiner — Wan Laymon

Assistant Examiner — Mark Booker

(74) *Attorney, Agent, or Firm* — Philip H. Burrus, IV

(57) **CLAIM**

The ornamental design for a skin stapler, as shown and described.

DESCRIPTION

FIG. 1 is a right side elevation view of one skin stapler showing my new design;
FIG. 2 is a left side elevation view thereof;
FIG. 3 is a top plan view thereof;
FIG. 4 is a bottom plan view thereof;
FIG. 5 is a front elevation view thereof;
FIG. 6 is a rear elevation view thereof;
FIG. 7 is a first perspective view thereof;
FIG. 8 is a second perspective view thereof;
FIG. 9 is a right side elevation view of another embodiment thereof, in a first position, showing my new design;
FIG. 10 is a left side elevation view thereof;
FIG. 11 is a top plan view thereof;
FIG. 12 is a bottom plan view thereof;
FIG. 13 is a first perspective view thereof;
FIG. 14 is a second perspective view thereof;
FIG. 15 is a right side elevation view of another embodiment thereof, in a second position, showing my new design;
FIG. 16 is a left side elevation view thereof;
FIG. 17 is a top plan view thereof;
FIG. 18 is a bottom plan view thereof;
FIG. 19 is a front elevation view thereof;
FIG. 20 is a rear elevation view thereof;
FIG. 21 is a first perspective view thereof; and,
FIG. 22 is a second perspective view thereof.
The dashed lines are included for the purpose of illustrating portions of the skin stapler that form no part of the claimed design.

1 Claim, 17 Drawing Sheets

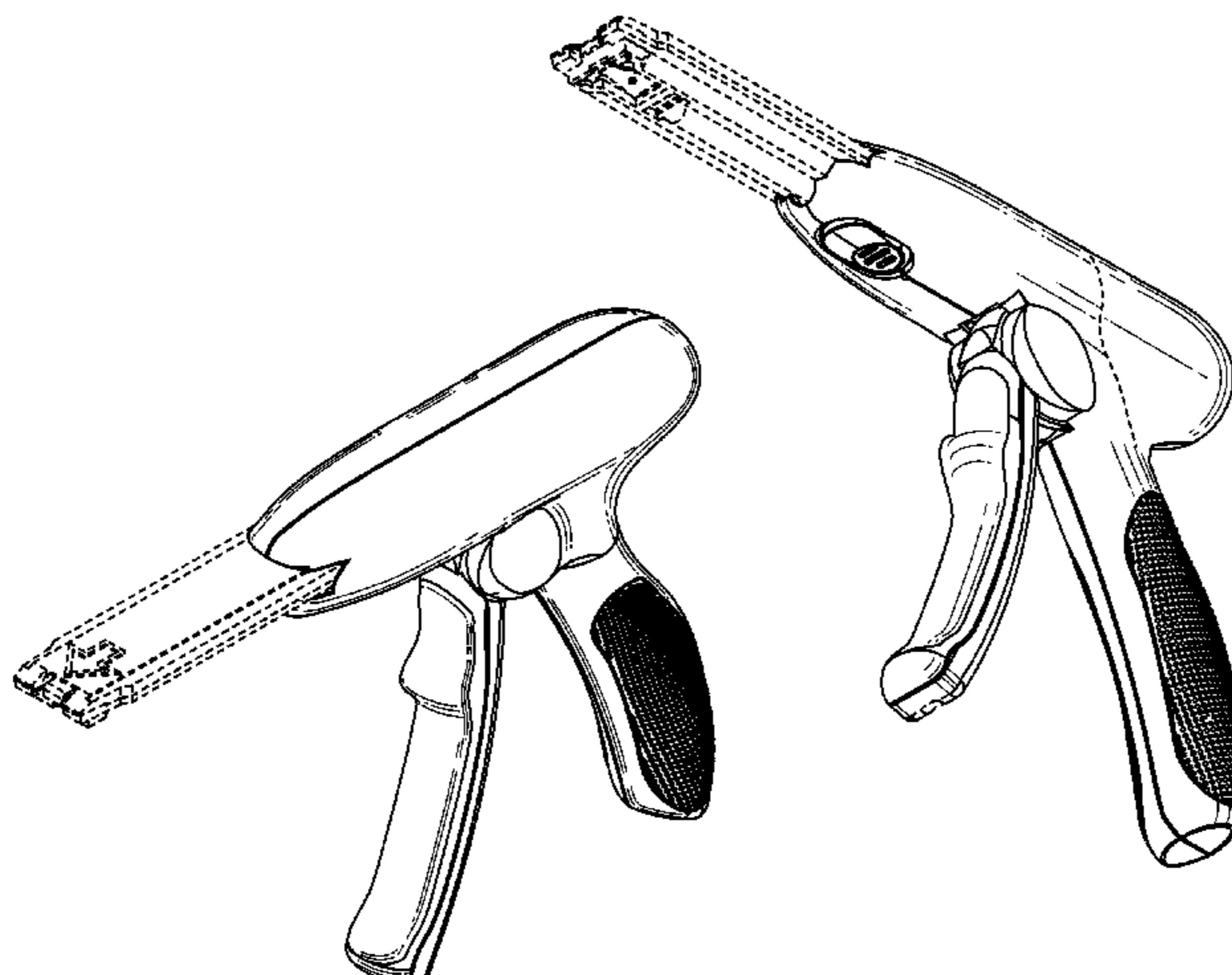

(56)

References Cited

U.S. PATENT DOCUMENTS

5,665,097	A *	9/1997	Baker	A61B 17/128 227/901
5,830,221	A *	11/1998	Stein	A61B 17/068 227/901
D502,994	S *	3/2005	Blake, III	D24/145
8,636,188	B2 *	1/2014	Buesseler	A61B 17/0643 227/175.1
8,789,736	B2 *	7/2014	Dudai	A61B 17/068 227/120

OTHER PUBLICATIONS

“Medline Catalog”, Apose Skin Stapler by Covidien; Medline Catalog; <http://www.medline.com/catalog/catalog.jsp>; Unknown Publication date but believed to be prior to present application filing date.

“Medline Catalog”, Disposable Skin Stapler by Covidien; Medline Catalog; <http://www.medline.com/catalog/catalog.jsp>; Unknown Publication date but believed to be prior to present application filing date.

“Medline Catalog”, Disposable Surgical Skin Stapler; Medline Catalog; <http://www.medline.com/catalog/catalog.jsp>; Unknown Publication date but believed to be prior to present application filing date.

“Medline Catalog”, Echelon Flex Powered Stapler; Johnson & Johnson; Medline Catalog; <http://www.medline.com/catalog/catalog.jsp>; Unknown Publication date but believed to be prior to present application filing date.

“Medline Product Catalog”, Endo Gia Ultra Universal Stapler by Covidien; Medline Catalog; <http://www.medline.com/catalog/catalog.jsp>; Unknown Publication date but believed to be prior to present application filing date.

“Medline Catalog”, Endo GIA Universal Stapler by Covidien; Medline Catalog; <http://www.medline.com/catalog/catalog.jsp>; Unknown Publication date but believed to be prior to present application filing date.

“Medline Catalog”, Endo GIA Ultra Universal Short Stapler by Covidien; Medline Catalog; <http://www.medline.com/catalog/catalog.jsp>; Unknown Publication date but believed to be prior to present application filing date.

“Medline Catalog”, INSORB Absorbable Stapler by Incisive Surgical; Medline Catalog; <http://www.medline.com/catalog/catalog.jsp>; Unknown Publication date but believed to be prior to present application filing date.

“Medline Catalog”, MultiFire Premium Single Use Skin Stapler; Medline Catalog; <http://www.medline.com/catalog/catalog.jsp>; Unknown Publication date but believed to be prior to present application filing date.

“Medline Catalog”, PGX Disposable Skin Stapler PGX-15W by 3M; Medline Catalog; <http://www.medline.com/catalog/catalog.jsp>; Unknown Publication date but believed to be prior to present application filing date.

“Medline Catalog”, Precise Multi-Shot DS Disposable Skin Stapler by 3M Healthcare; Medline Catalog; <http://www.medline.com/catalog/catalog.jsp>; Unknown Publication date but believed to be prior to present application filing date.

“Medline Catalog”, Precise PGX Skin Stapler by 3M Healthcare; Medline Catalog; <http://www.medline.com/catalog/catalog.jsp>; Unknown Publication date but believed to be prior to present application filing date.

“Medline Catalog”, Precise Vista Disposable Skin Stapler 3997 by 3M Healthcare; Medline Catalog; <http://www.medline.com/catalog/catalog.jsp>; Unknown Publication date but believed to be prior to present application filing date.

“Medline Catalog”, Precise Vista Disposable Skin Stapler by 3M Healthcare; Medline Catalog; <http://www.medline.com/catalog/catalog.jsp>; Unknown Publication date but believed to be prior to present application filing date.

“Medline Catalog”, Proximate Skin Staplers by Ethicon; Medline Catalog; <http://www.medline.com/catalog/catalog.jsp>; Unknown Publication date but believed to be prior to present application filing date.

“Medline Catalog”, Reflex Skin Staplers by Conmed; Medline Catalog; <http://www.medline.com/catalog/catalog.jsp>; Unknown Publication date but believed to be prior to present application filing date.

“Medline Catalog”, Rotating Head Skin Staplers by DeRoyal; Medline Catalog; <http://www.medline.com/catalog/catalog.jsp>; Unknown Publication date but believed to be prior to present application filing date.

“Medline Catalog”, Reticulatur 55 Poly Stapler by Covidien; Medline Catalog; <http://www.medline.com/catalog/catalog.jsp>; Unknown Publication date but believed to be prior to present application filing date.

“Medline Catalog”, Signet Disposable Skin Stapler by Covidien; Medline Catalog; <http://www.medline.com/catalog/catalog.jsp>; Unknown Publication date but believed to be prior to present application filing date.

“Medline Catalog”, Skin Staplers by DeRoyal; Medline Catalog; <http://www.medline.com/catalog/catalog.jsp>; Unknown Publication date but believed to be prior to present application filing date.

“Medline Catalog”, Stapler Skin 35 Count, STRL; Medline Catalog; <http://www.medline.com/catalog/catalog.jsp>; Unknown Publication date but believed to be prior to present application filing date.

“Medline Catalog”, Weck Disposable Skin Staplers by Teleflex; Medline Catalog; <http://www.medline.com/catalog/catalog.jsp>; Unknown Publication date but believed to be prior to present application filing date.

“Medline Catalog”, Weck Rotating Head Stapler by Teleflex M; Medline Catalog; <http://www.medline.com/catalog/catalog.jsp>; Unknown Publication date but believed to be prior to present application filing date.

* cited by examiner

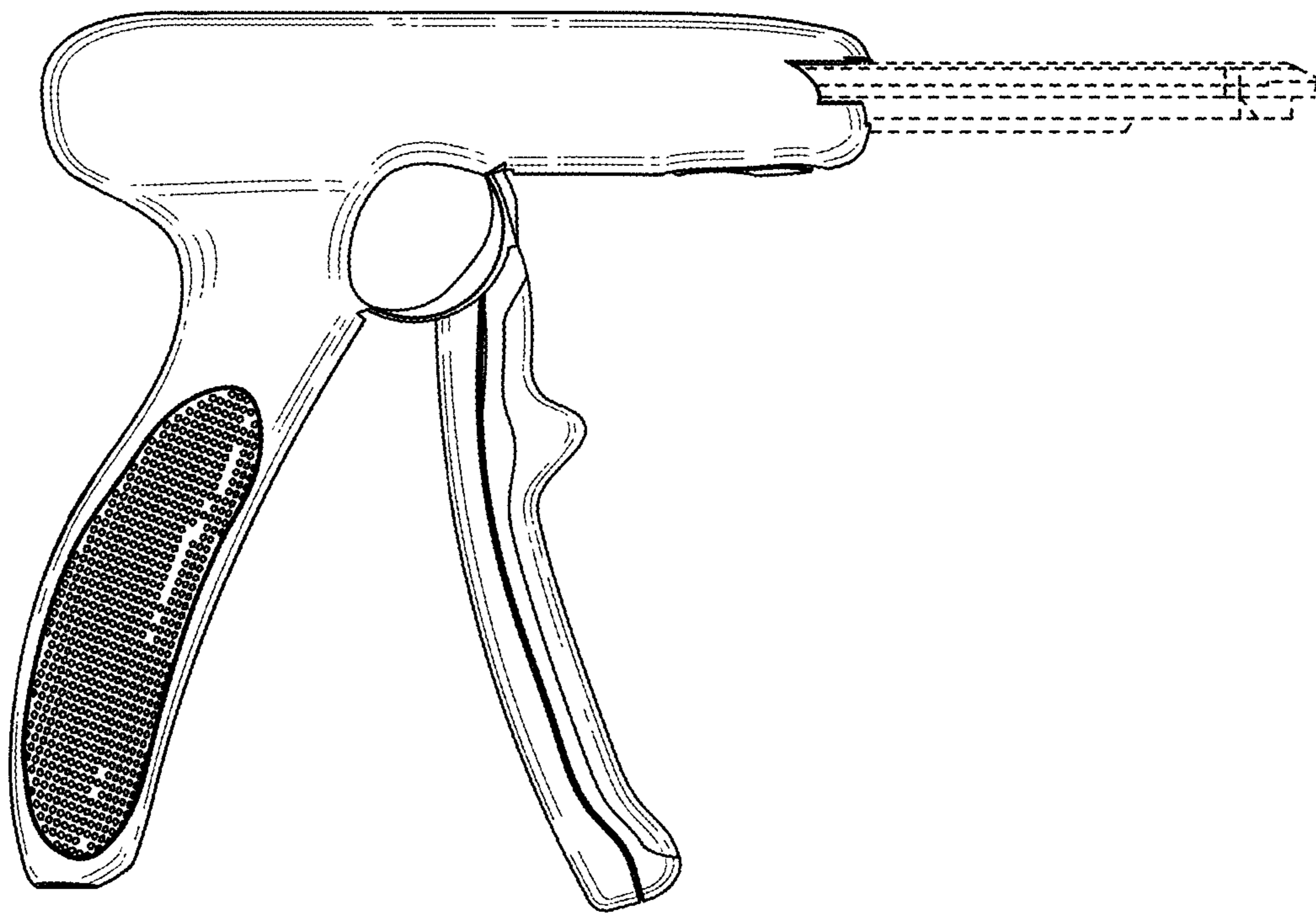

FIG. 1

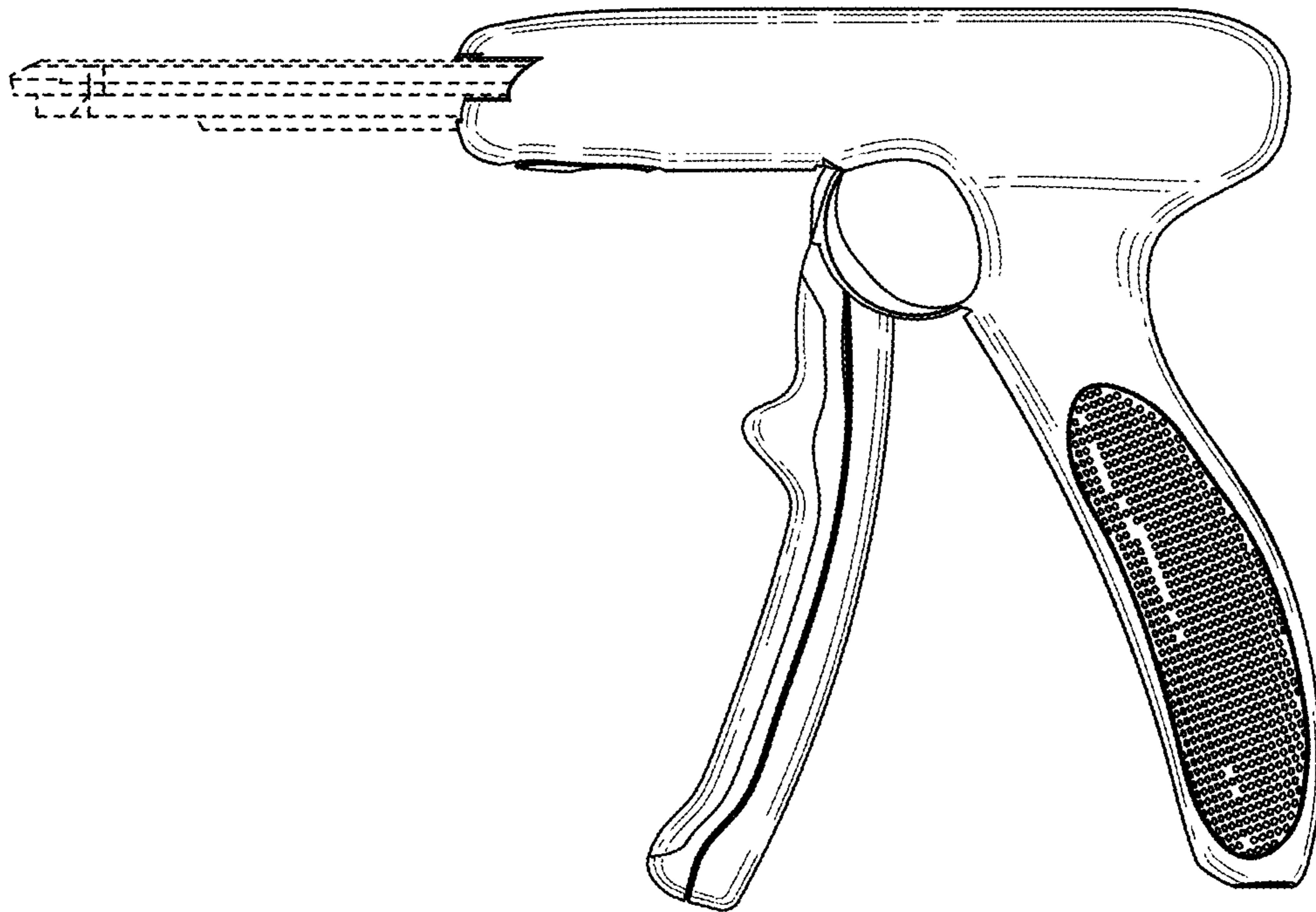

FIG. 2

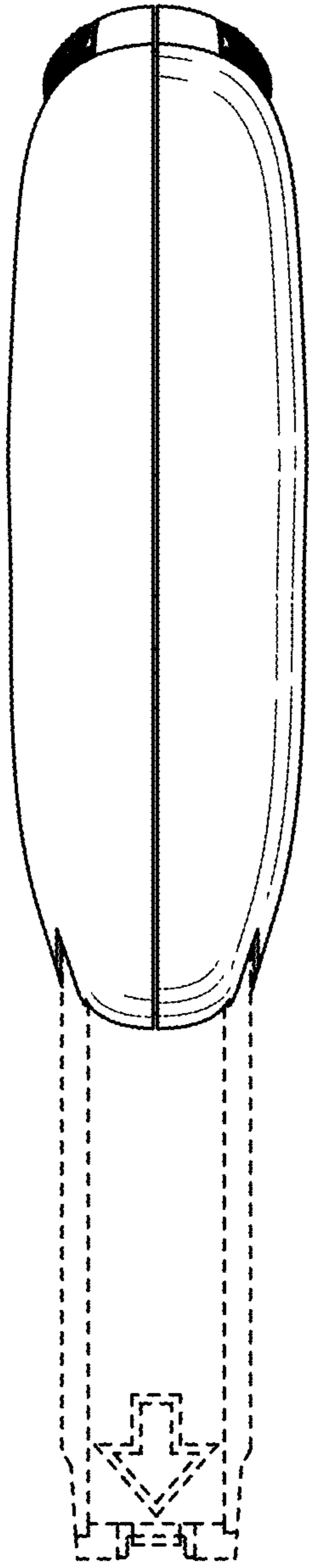

FIG. 3

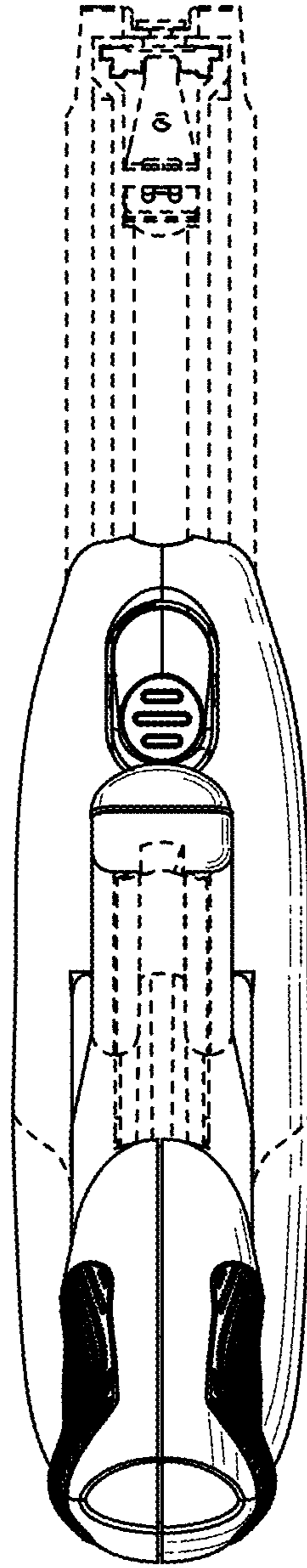

FIG. 4

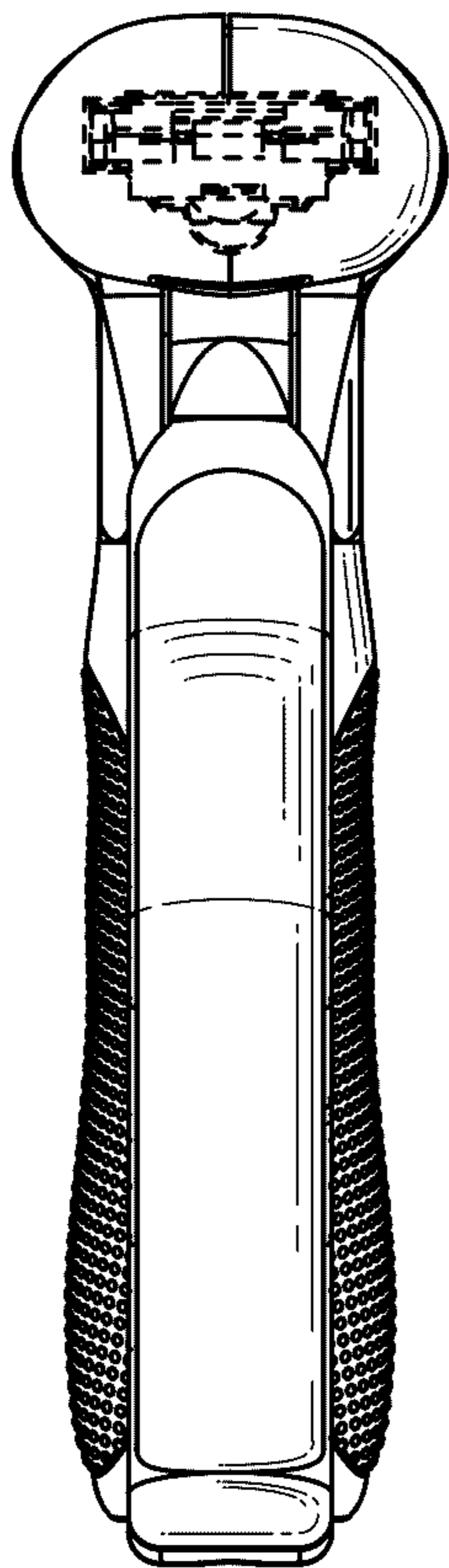

FIG. 5

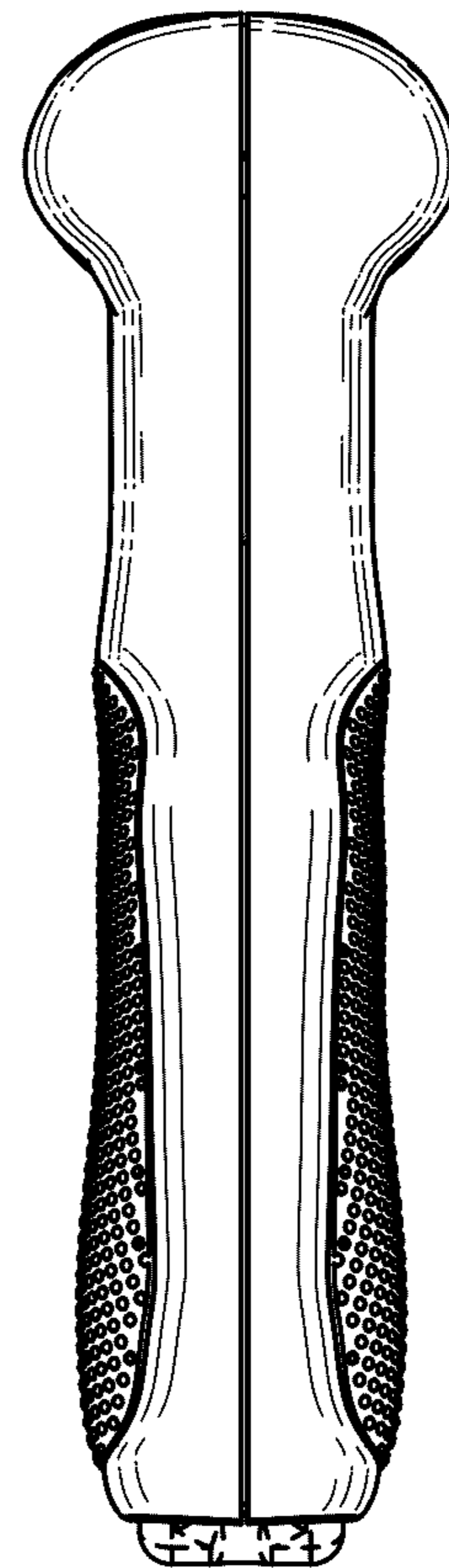

FIG. 6

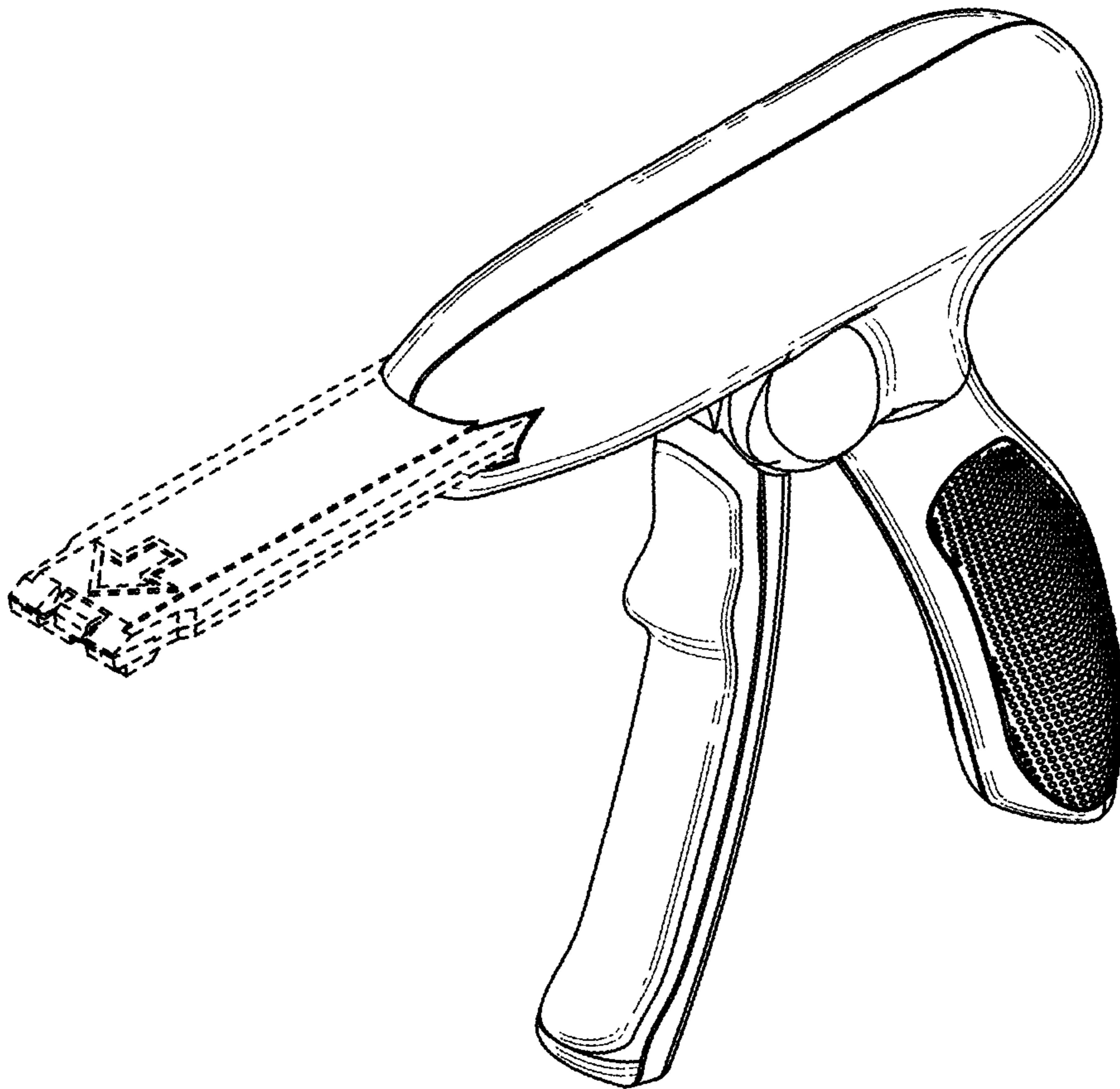

FIG. 7

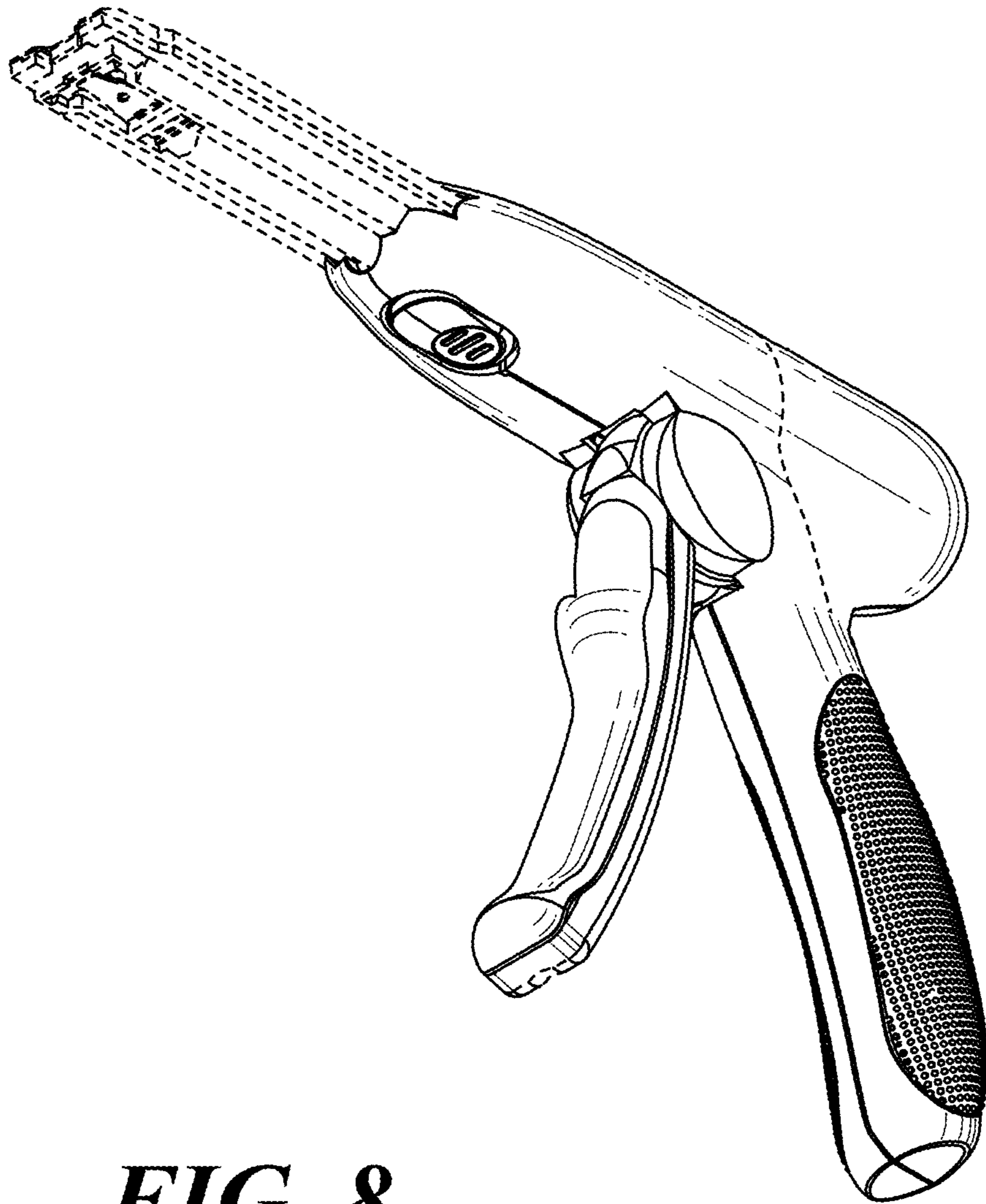

FIG. 8

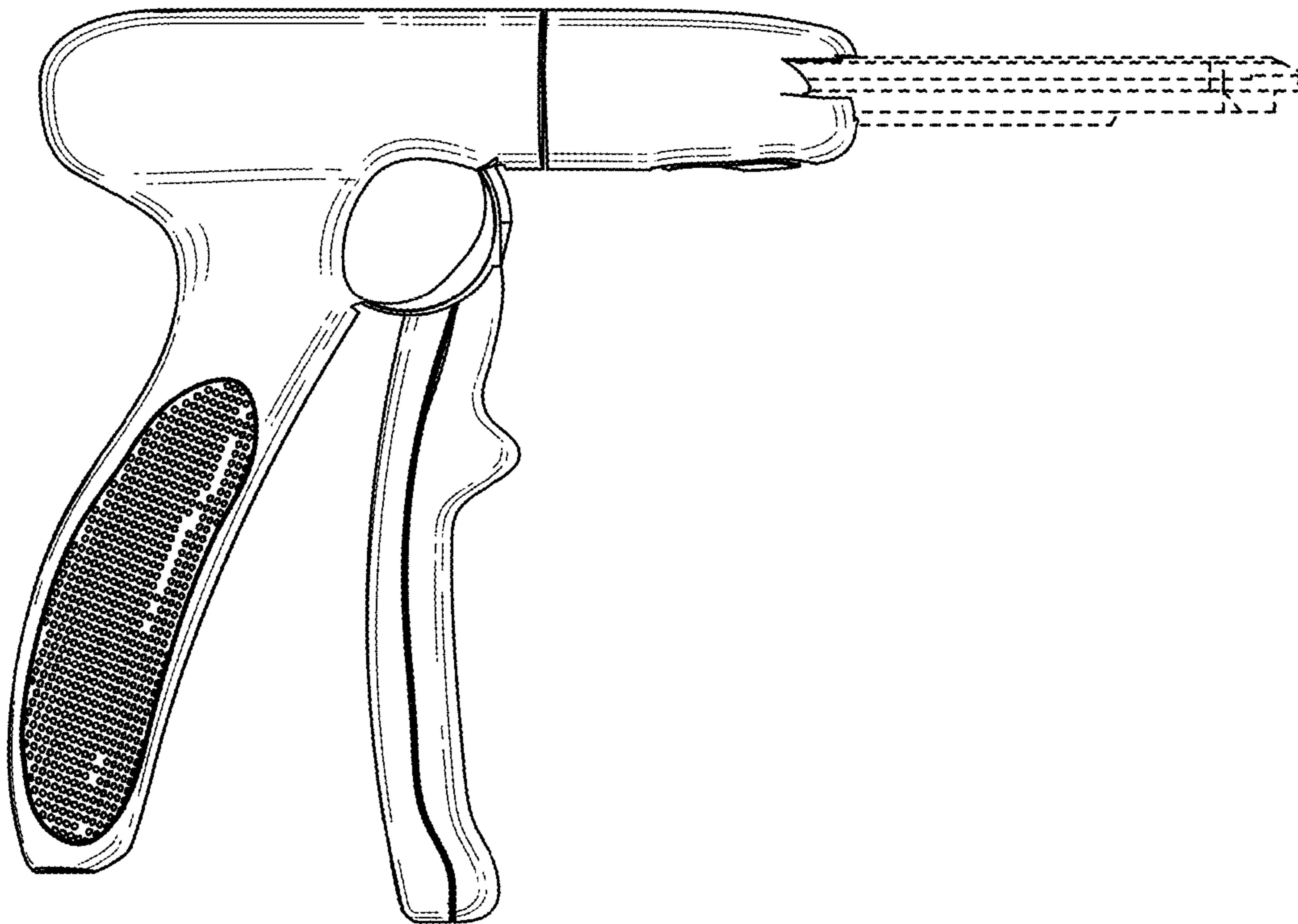

FIG. 9

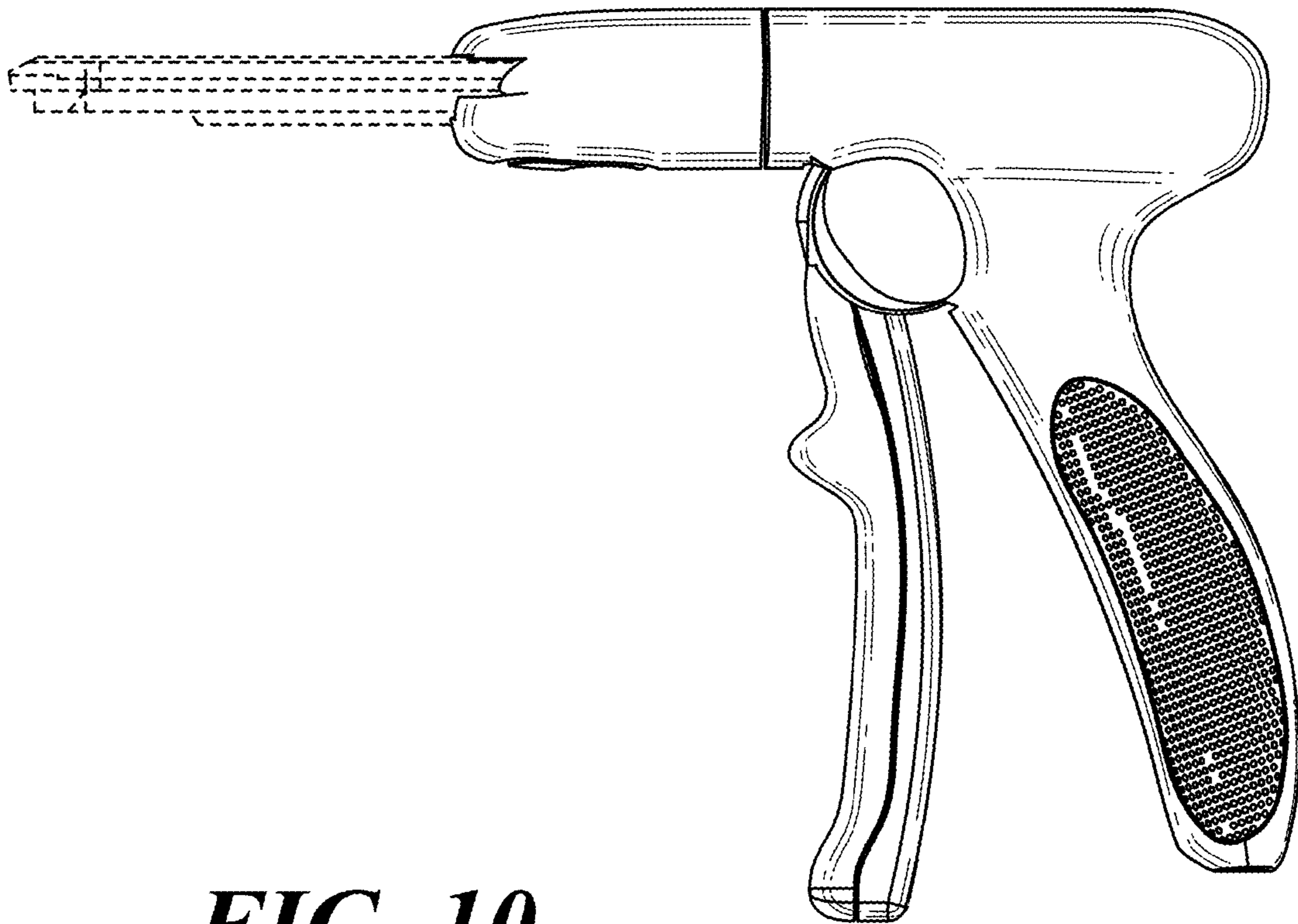

FIG. 10

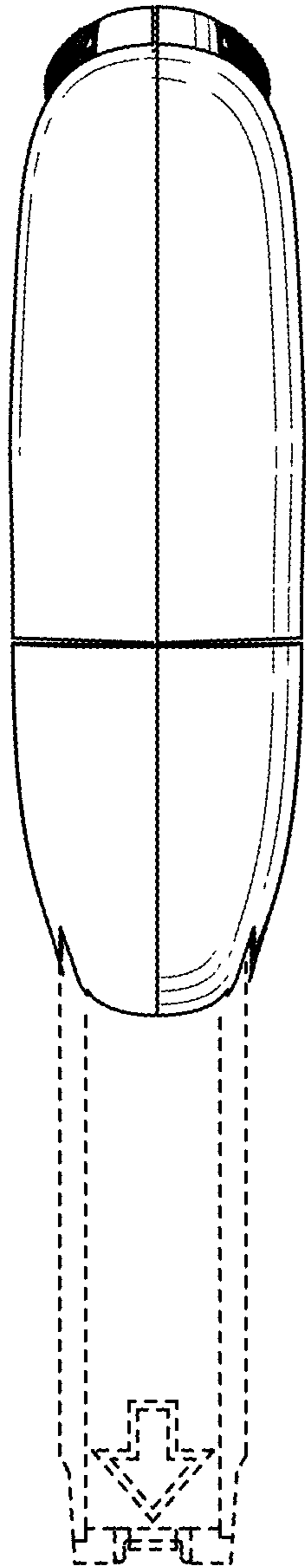

FIG. 11

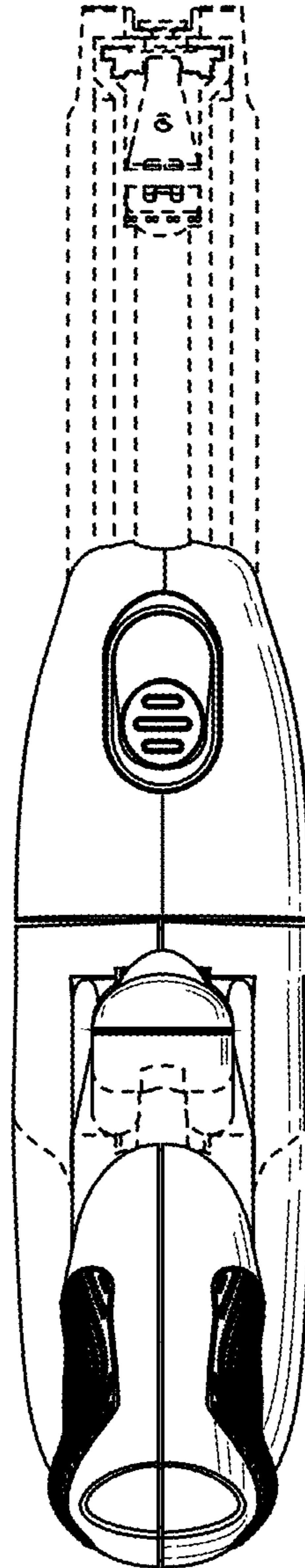

FIG. 12

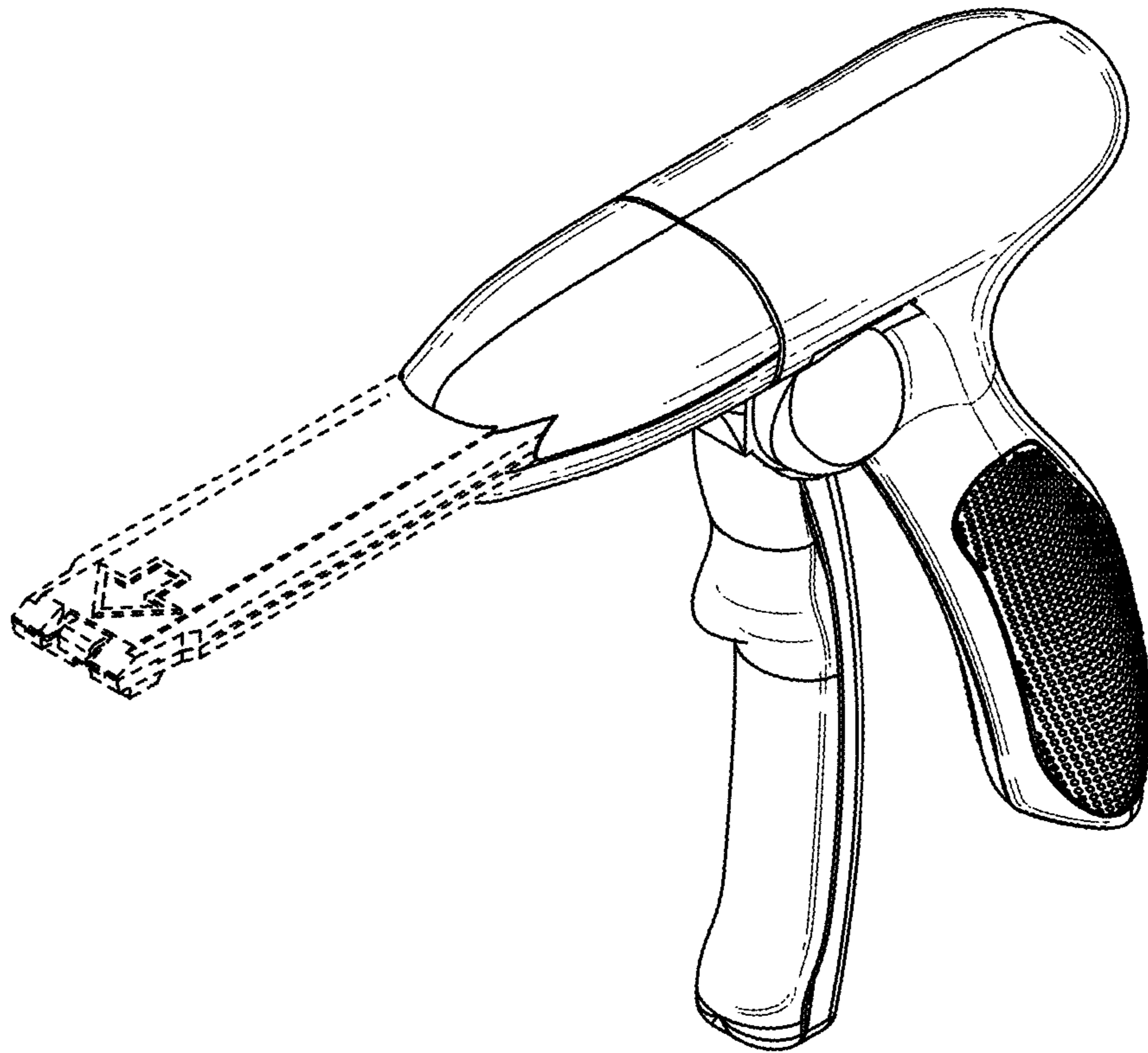

FIG. 13

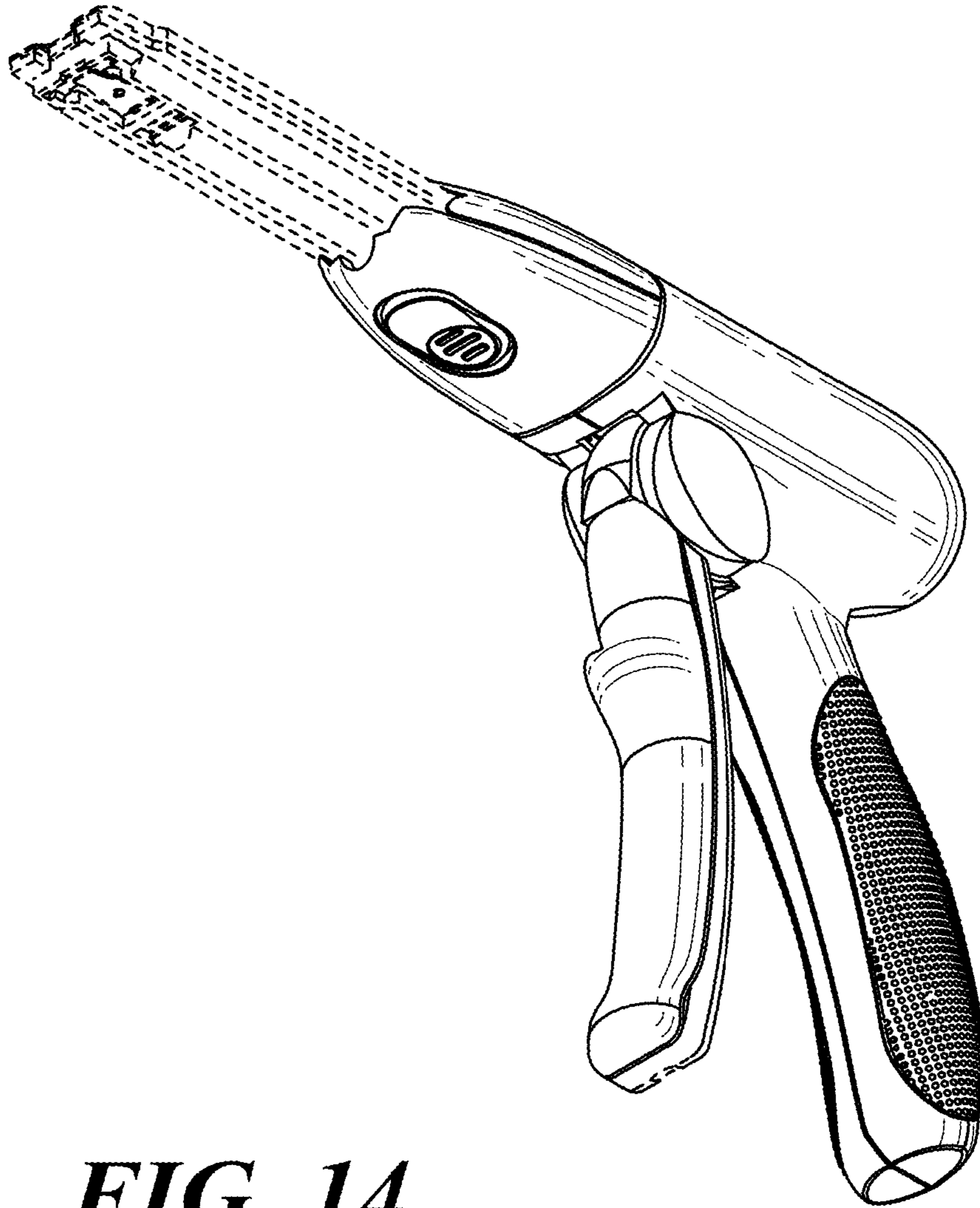

FIG. 14

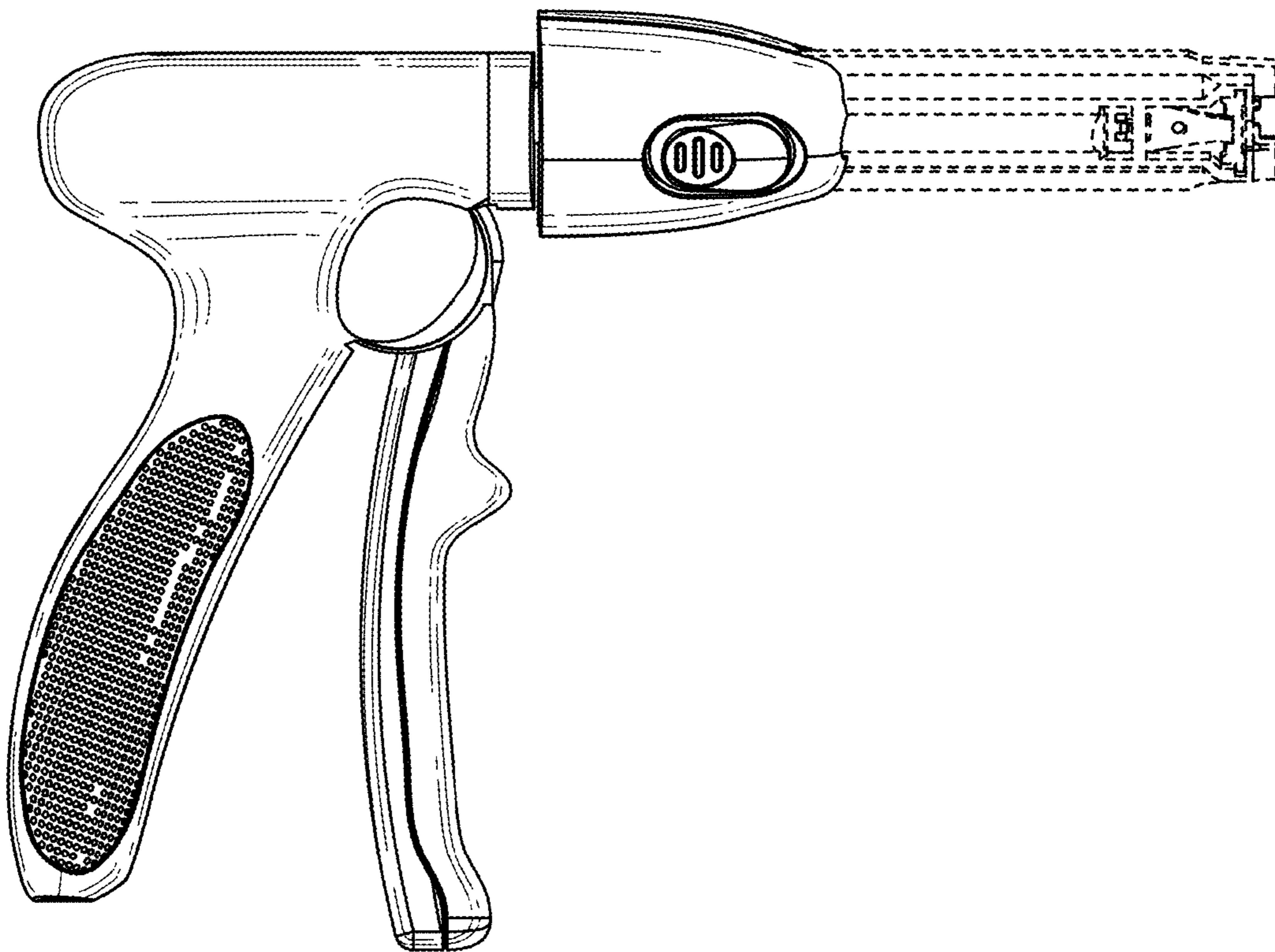

FIG. 15

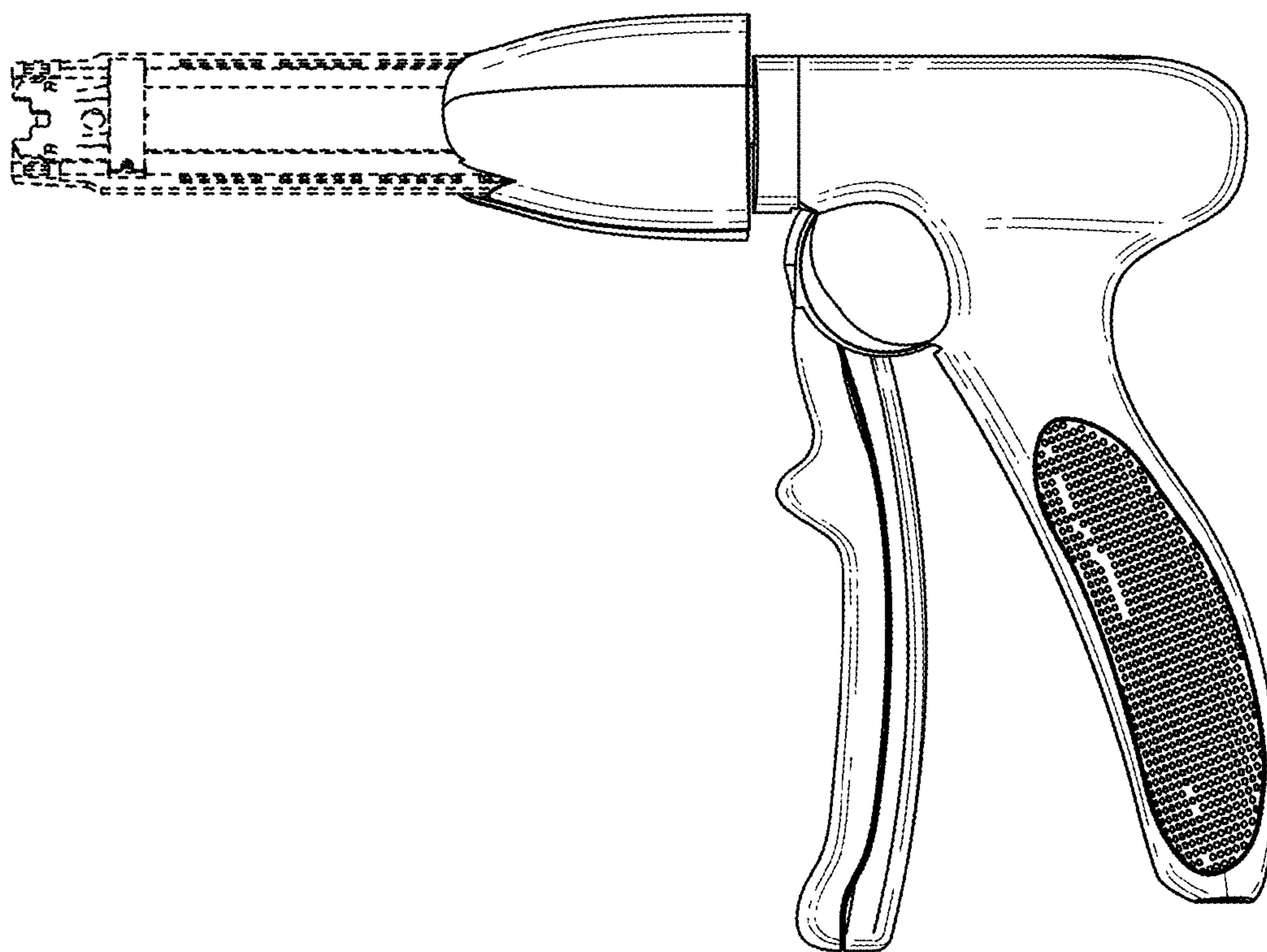

FIG. 16

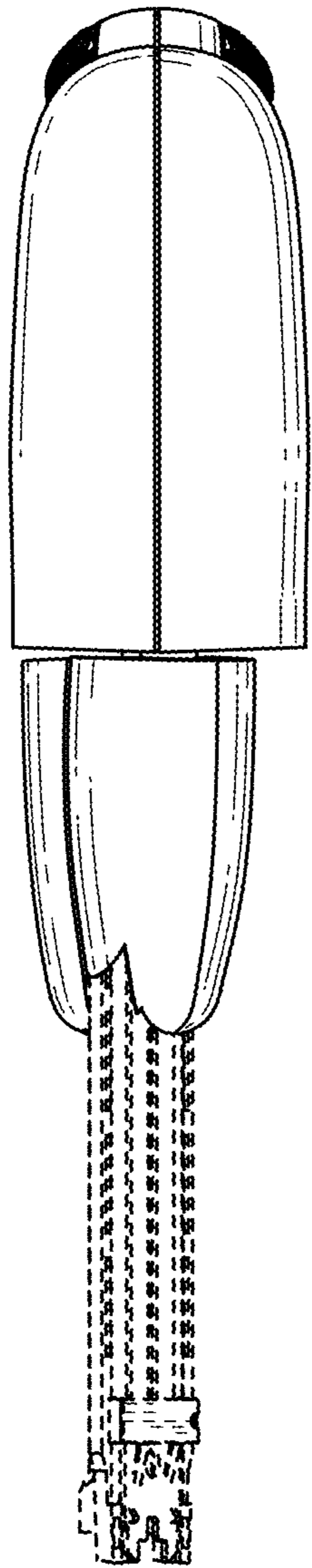

FIG. 17

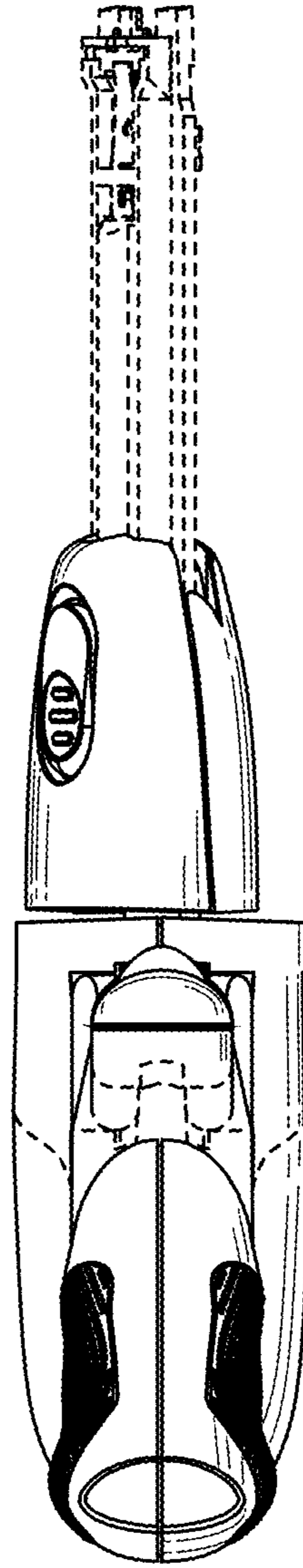

FIG. 18

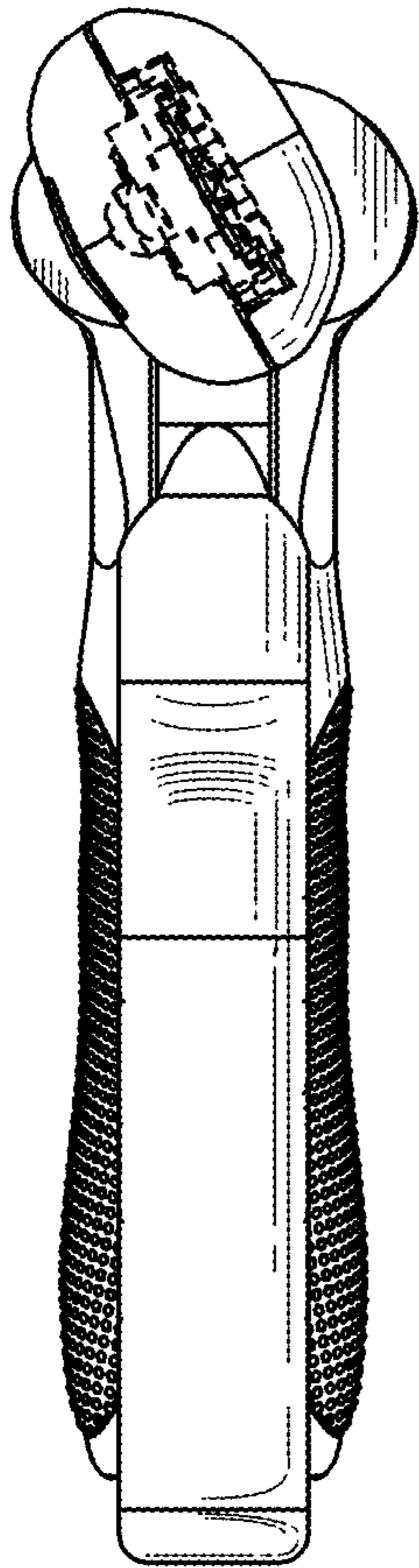

FIG. 19

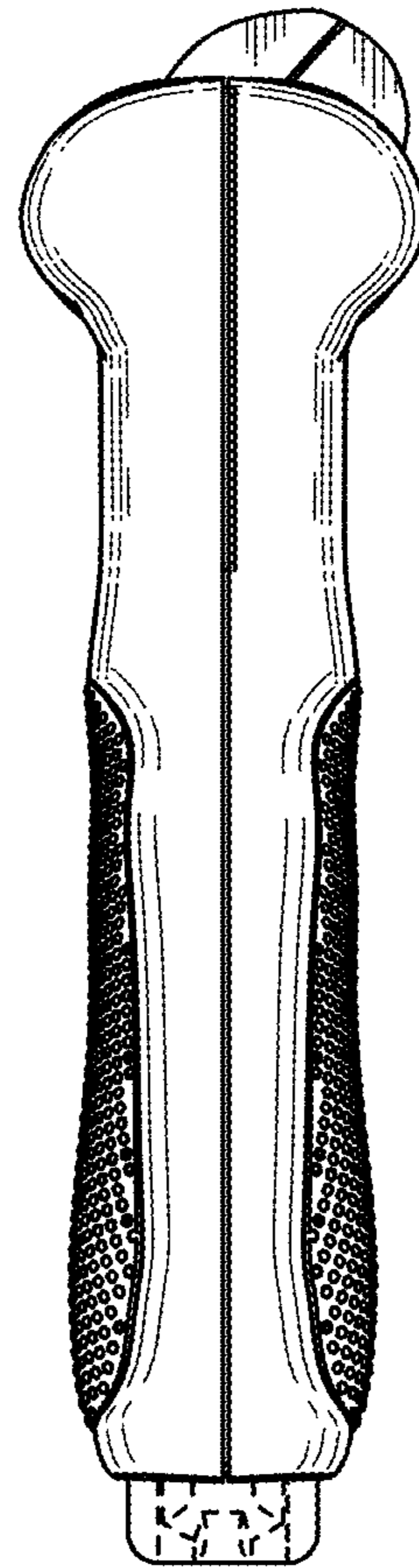

FIG. 20

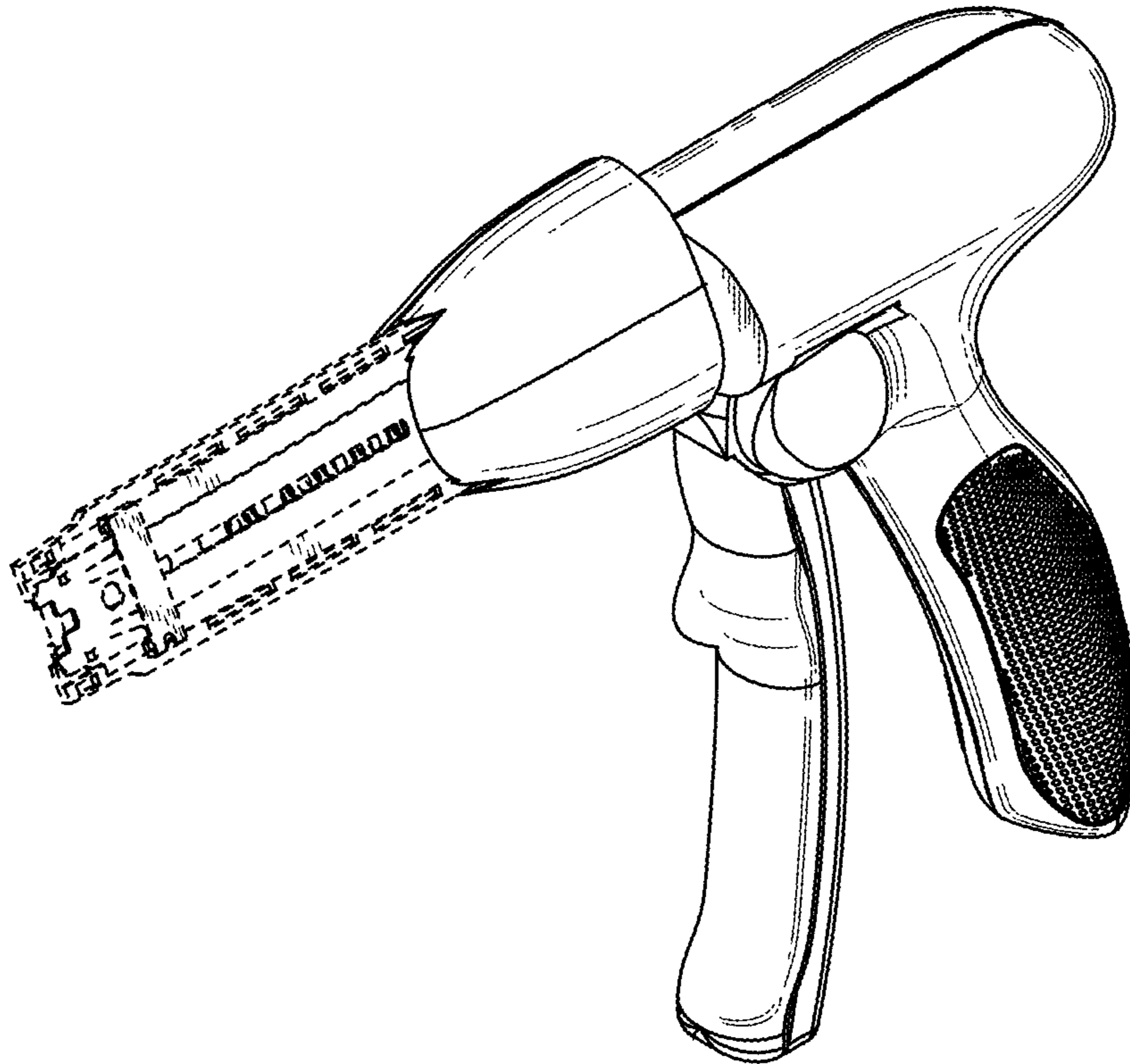

FIG. 21

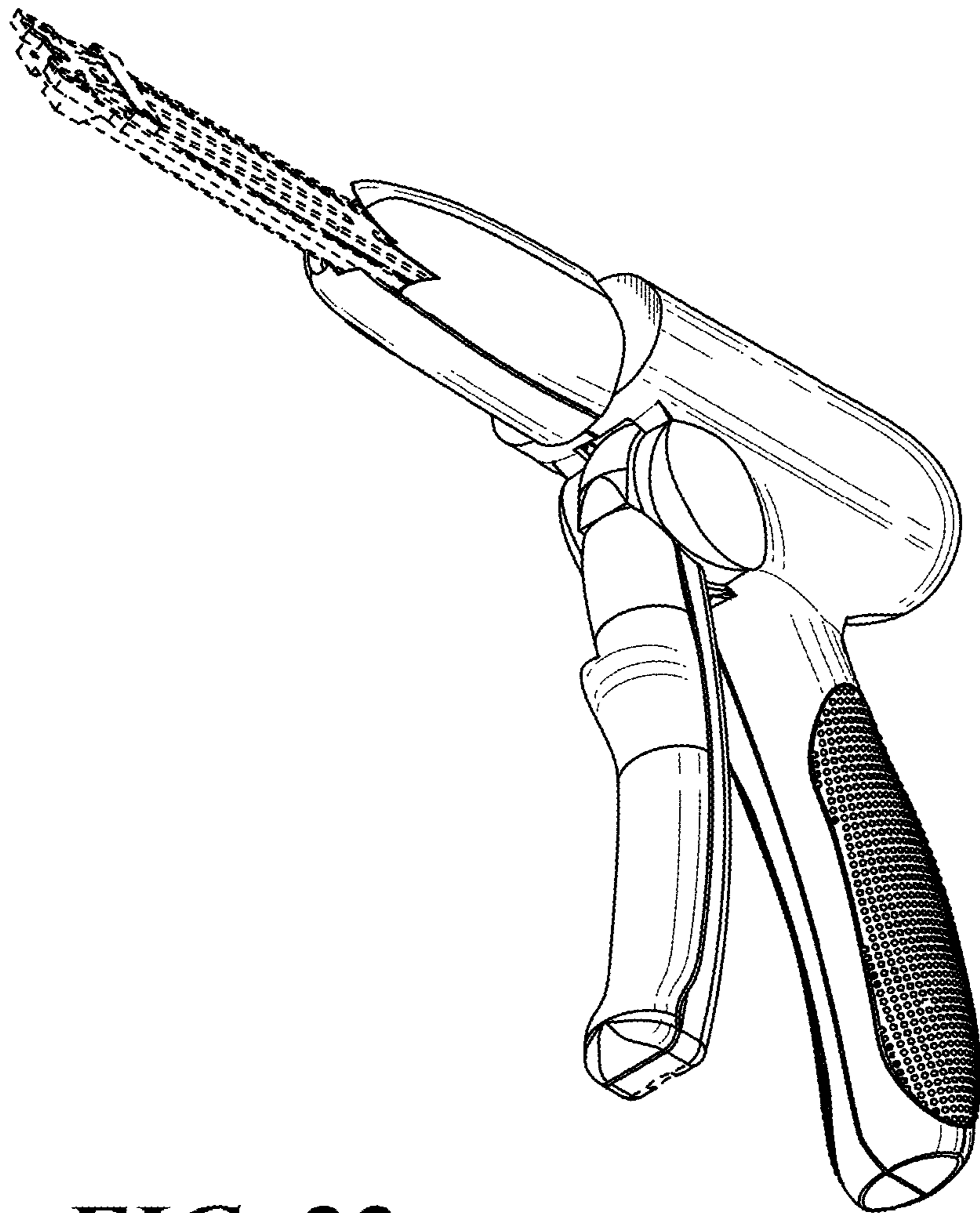

FIG. 22