



US00D770592S

(12) **United States Design Patent**
Schwartz et al.

(10) **Patent No.:** **US D770,592 S**

(45) **Date of Patent:** **** Nov. 1, 2016**

(54) **FILTER ELEMENT**

(71) Applicant: **Cummins Filtration IP, Inc.**,
Columbus, IN (US)

(72) Inventors: **Scott W. Schwartz**, Cottage Grove, WI (US); **Robert A. Bannister**, Stoughton, WI (US); **Joel D. Roltgen**, DeForest, WI (US); **Jeffrey A. Rech**, Verona, WI (US); **Stephen L. Fallon**, Oregon, WI (US); **Gregory K. Loken**, Stoughton, WI (US)

(73) Assignee: **CUMMINS FILTRATION IP, INC.**,
Columbus, IN (US)

(**) Term: **14 Years**

(21) Appl. No.: **29/525,960**

(22) Filed: **May 5, 2015**

(51) **LOC (10) Cl.** **23-01**

(52) **U.S. Cl.**
USPC **D23/209**

(58) **Field of Classification Search**

USPC D23/207, 209; D7/400; 210/232, 282,
210/244, 238, 493.2; 285/360, 361
CPC C02F 1/003; B01D 35/30; B01D 35/153;
B01D 35/157

See application file for complete search history.

(56) **References Cited**

U.S. PATENT DOCUMENTS

4,138,337 A 2/1979 Smith
(Continued)

FOREIGN PATENT DOCUMENTS

WO WO2015/171744 11/2015

OTHER PUBLICATIONS

International Search Report and Written Opinion for PCT/US2015/029443, issued Jul. 28, 2015, 8 pages.

Primary Examiner — Robin V Webster

(74) *Attorney, Agent, or Firm* — Foley & Lardner LLP

(57) **CLAIM**

We claim the ornamental design for a filter element, as shown and described.

DESCRIPTION

FIG. 1 is a first isometric view of a filter element according to a first embodiment;

FIG. 2 is a second isometric view thereof;

FIG. 3 is a front elevational view thereof;

FIG. 4 is a rear elevational view thereof;

FIG. 5 is a right side elevational view thereof;

FIG. 6 is a left side elevational view thereof;

FIG. 7 is a top plan view thereof;

FIG. 8 is a bottom plan view thereof;

FIG. 9 is a cross-sectional view taken along line 9-9 of FIG. 8, the cross-sectional view in the opposite direction being a mirror image thereof;

FIG. 10 is a cross-sectional view taken along line 10-10 of FIG. 8;

FIG. 11 is a cross-sectional view taken along line 11-11 of FIG. 8;

FIG. 12 is a first isometric view of a filter element according to a second embodiment;

FIG. 13 is a second isometric view thereof;

FIG. 14 is a front elevational view thereof;

FIG. 15 is a rear elevational view thereof;

FIG. 16 is a right side elevational view thereof;

FIG. 17 is a left side elevational view thereof;

FIG. 18 is a top plan view thereof;

FIG. 19 is a bottom plan view thereof;

FIG. 20 is a cross-sectional view taken along line 20-20 of FIG. 19, the cross-sectional view in the opposite direction being a mirror image thereof;

FIG. 21 is a cross-sectional view taken along line 21-21 of FIG. 19; and,

FIG. 22 is a cross-sectional view taken along line 22-22 of FIG. 19.

The ornamental design which is claimed is shown in solid lines in the drawings. The dashed lines in the drawings represent a boundary of claimed subject matter, and the dashed lines form no part of the claimed design. The dash-dot-dash lines in the drawings illustrate unclaimed subject matter and form no part of the claimed design.

1 Claim, 22 Drawing Sheets

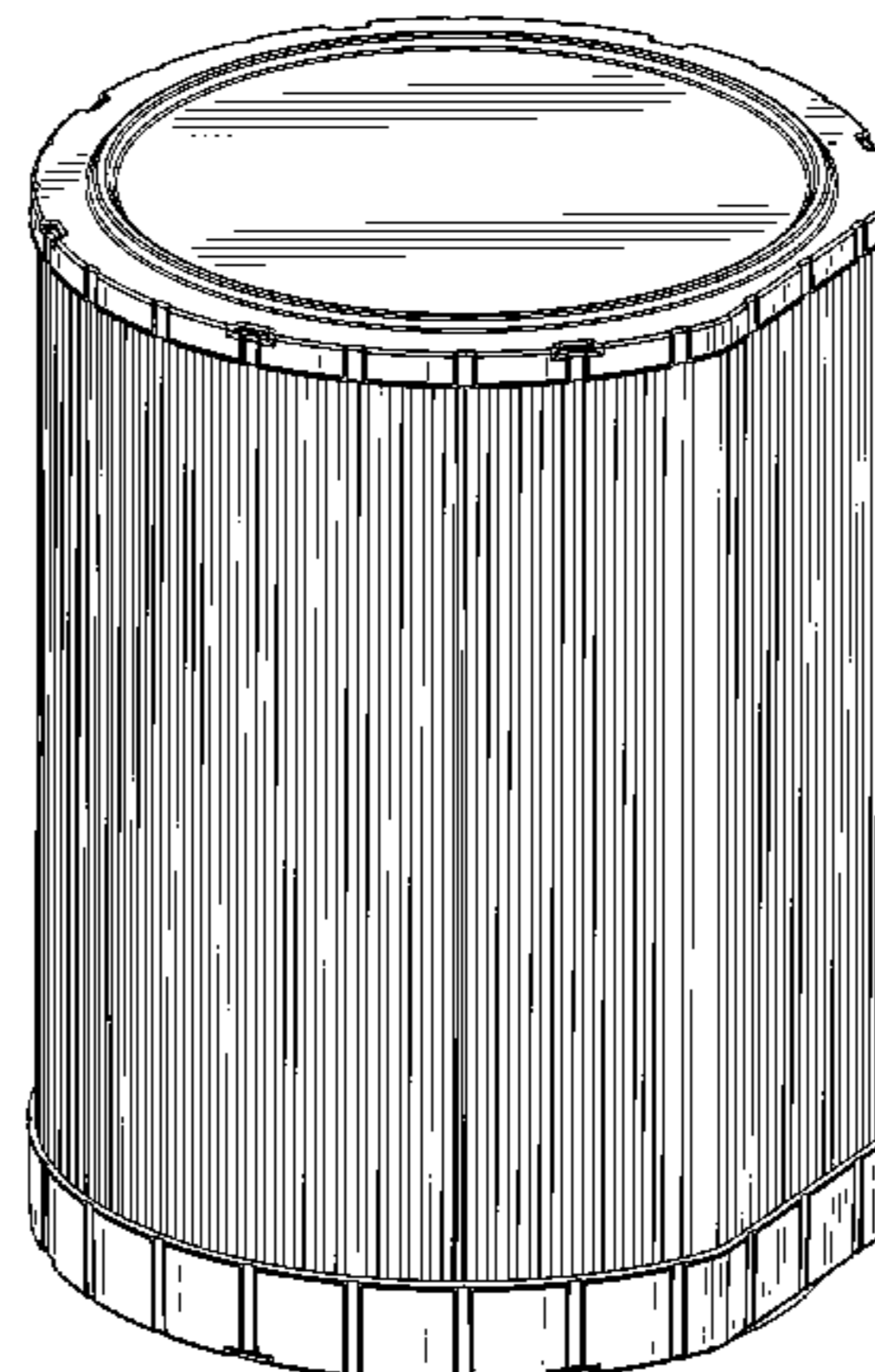
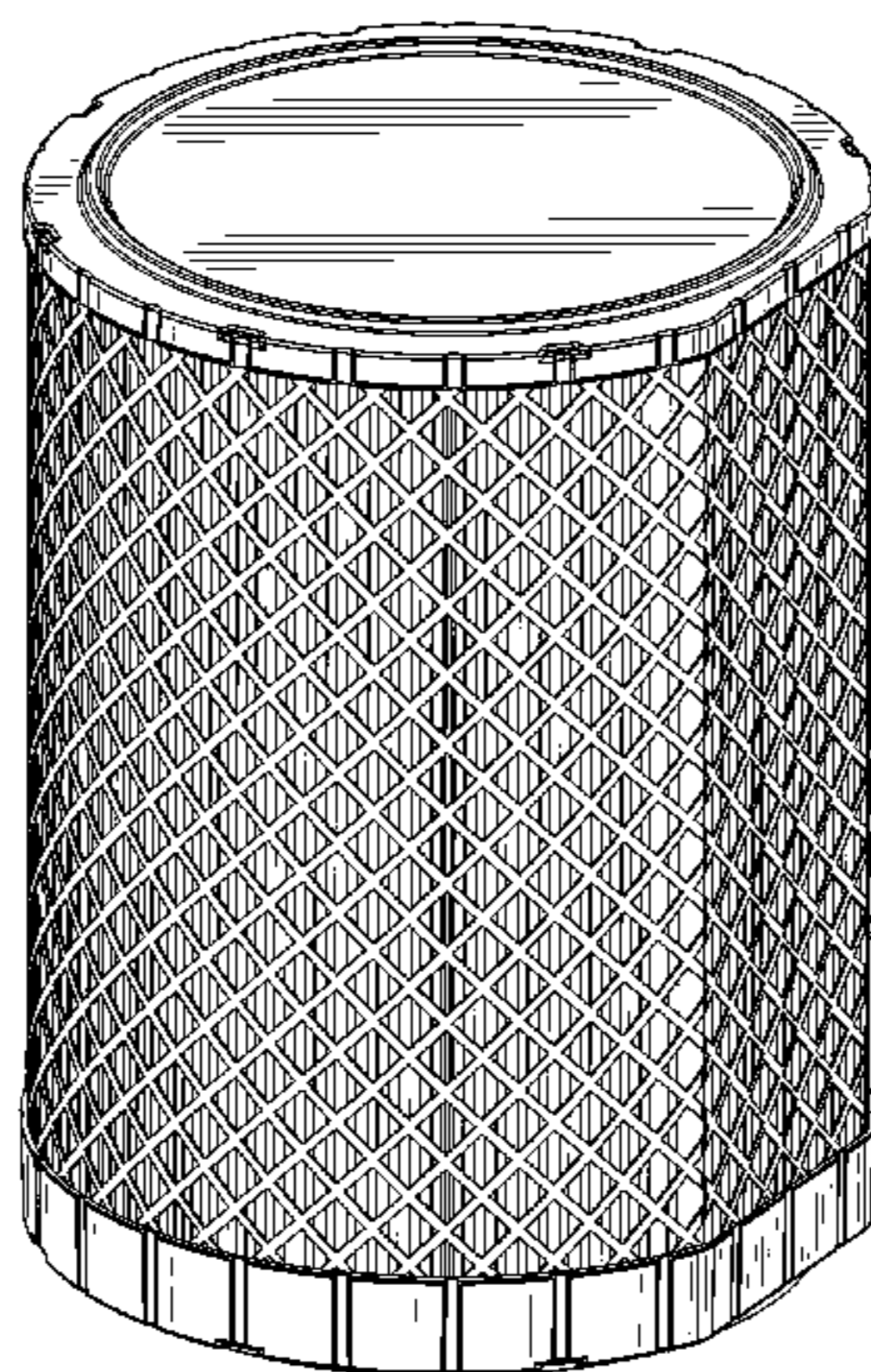

(56)

References Cited

U.S. PATENT DOCUMENTS

4,878,930 A 11/1989 Manniso et al.
 D414,544 S 9/1999 Ward et al.
 5,997,674 A 12/1999 Rakocy et al.
 6,156,198 A 12/2000 Bartels
 D470,216 S 2/2003 Gustafson et al.
 7,387,726 B2 6/2008 Wolf et al.
 7,922,006 B2* 4/2011 Fall B01D 29/111
 210/338
 8,167,966 B2* 5/2012 Amirkhanian B01D 46/008
 210/470

8,431,021 B2* 4/2013 McCague C02F 1/001
 210/167.11
 D682,390 S 5/2013 Harder
 8,741,138 B2 6/2014 Oelschlaegel
 8,864,866 B2* 10/2014 Osendorf B01D 46/0005
 210/493.2
 D726,869 S * 4/2015 Lepine D23/209
 D735,293 S 7/2015 Schwartz et al.
 9,168,470 B2* 10/2015 Moreno Linares .. B01D 35/147
 2006/0070945 A1 4/2006 Men et al.
 2012/0060453 A1 3/2012 Holzmann et al.
 2013/0232934 A1 9/2013 Baseotto

* cited by examiner

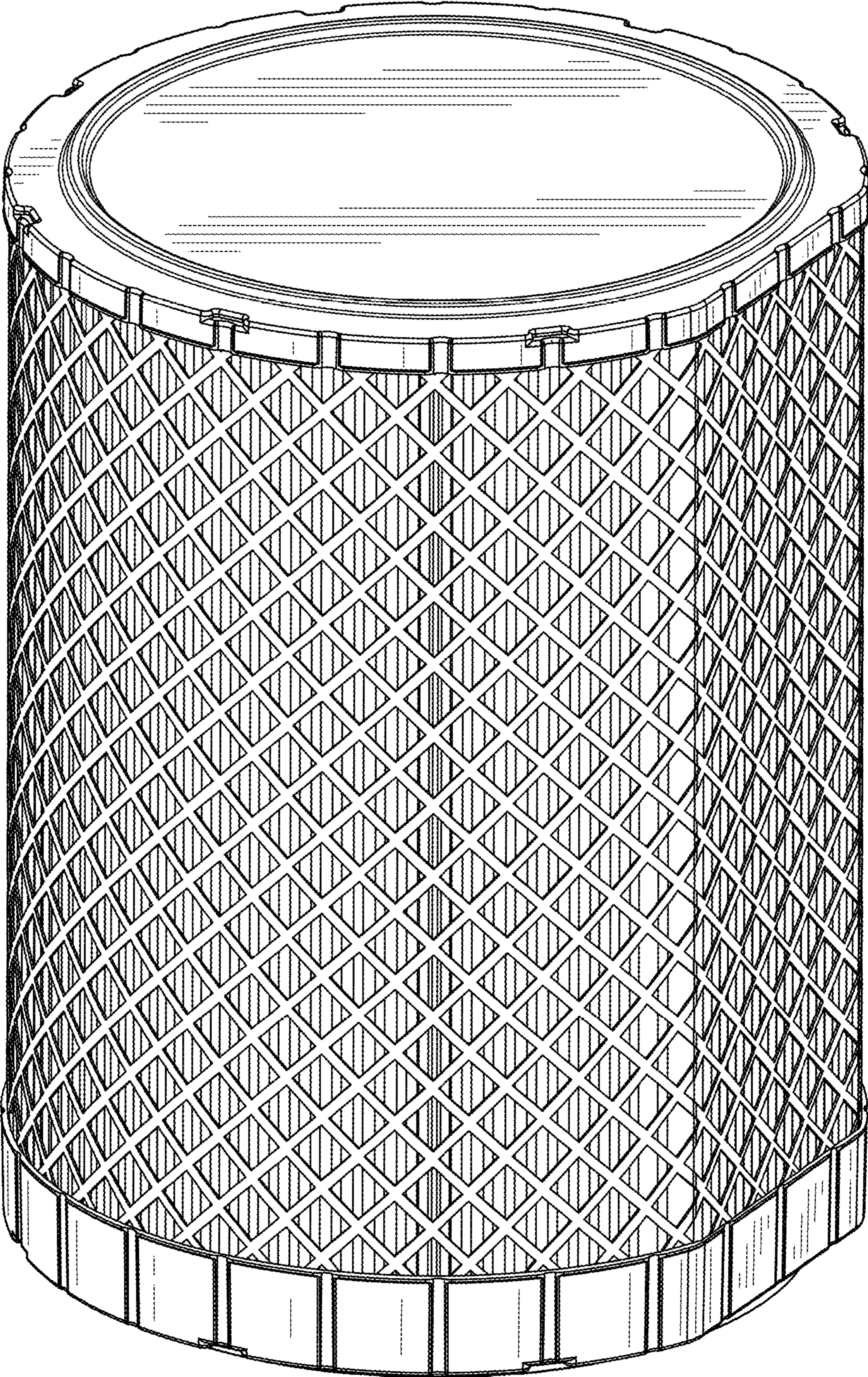

FIG. 1

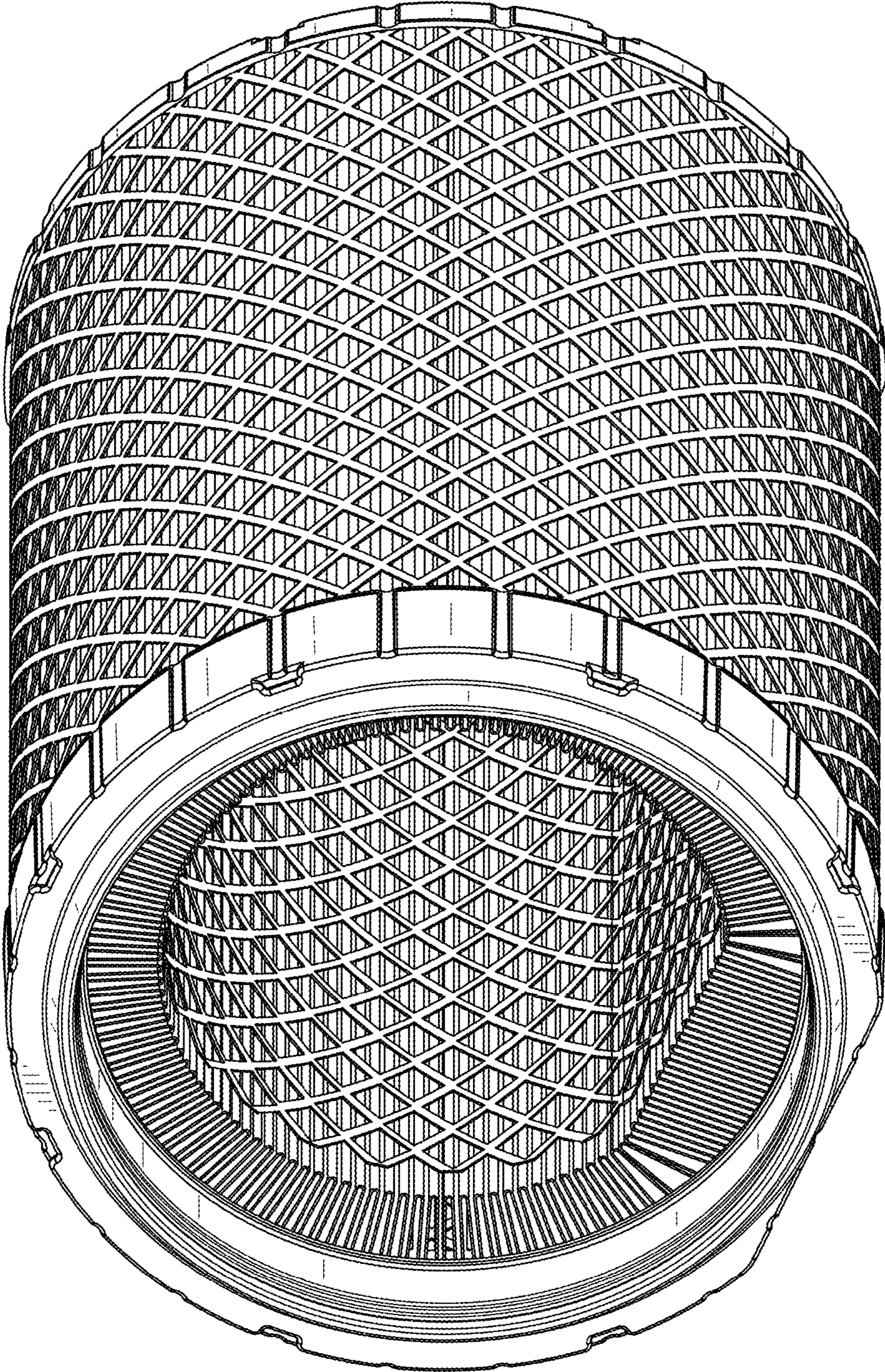

FIG. 2

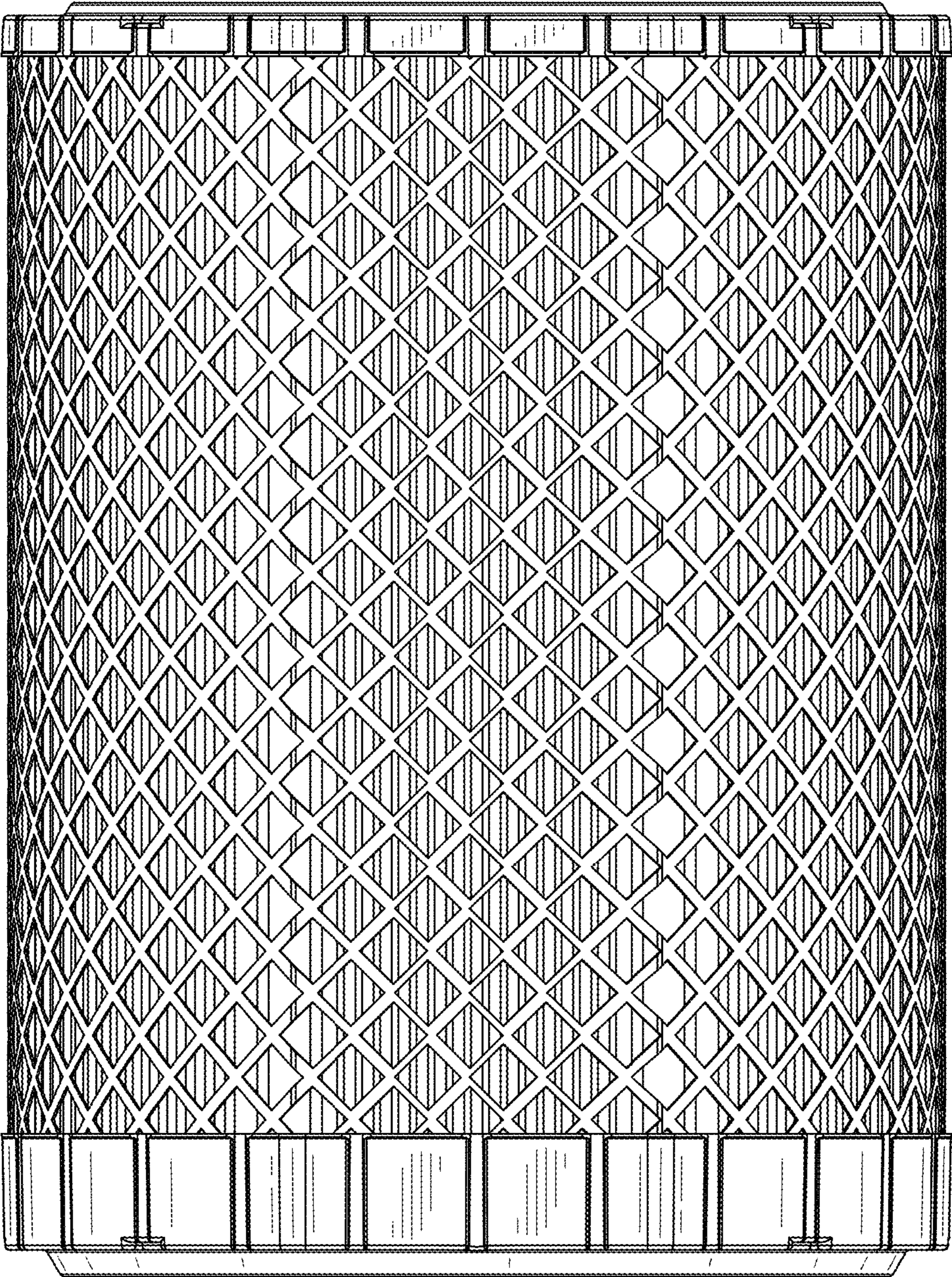

FIG. 3

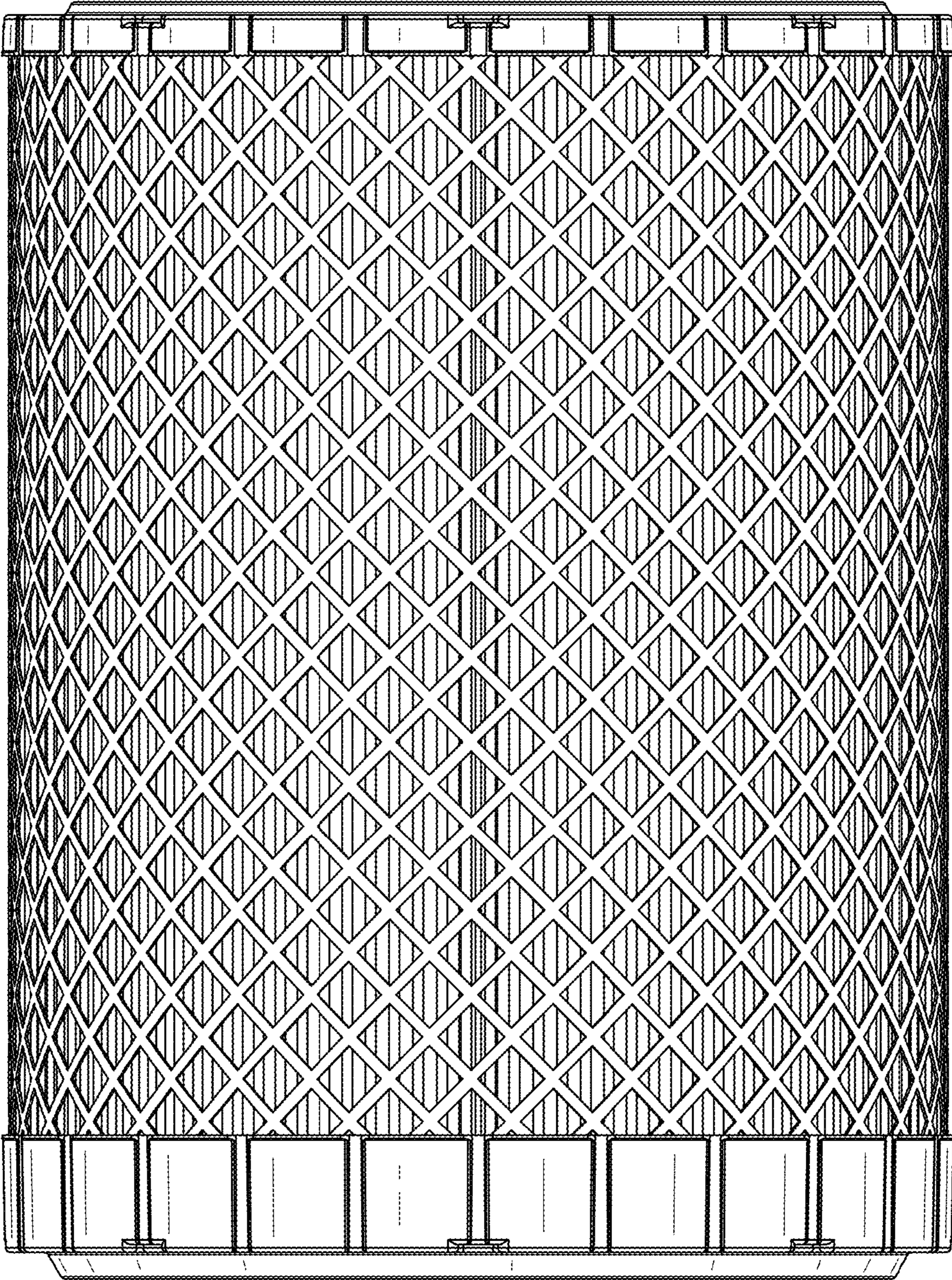

FIG. 4

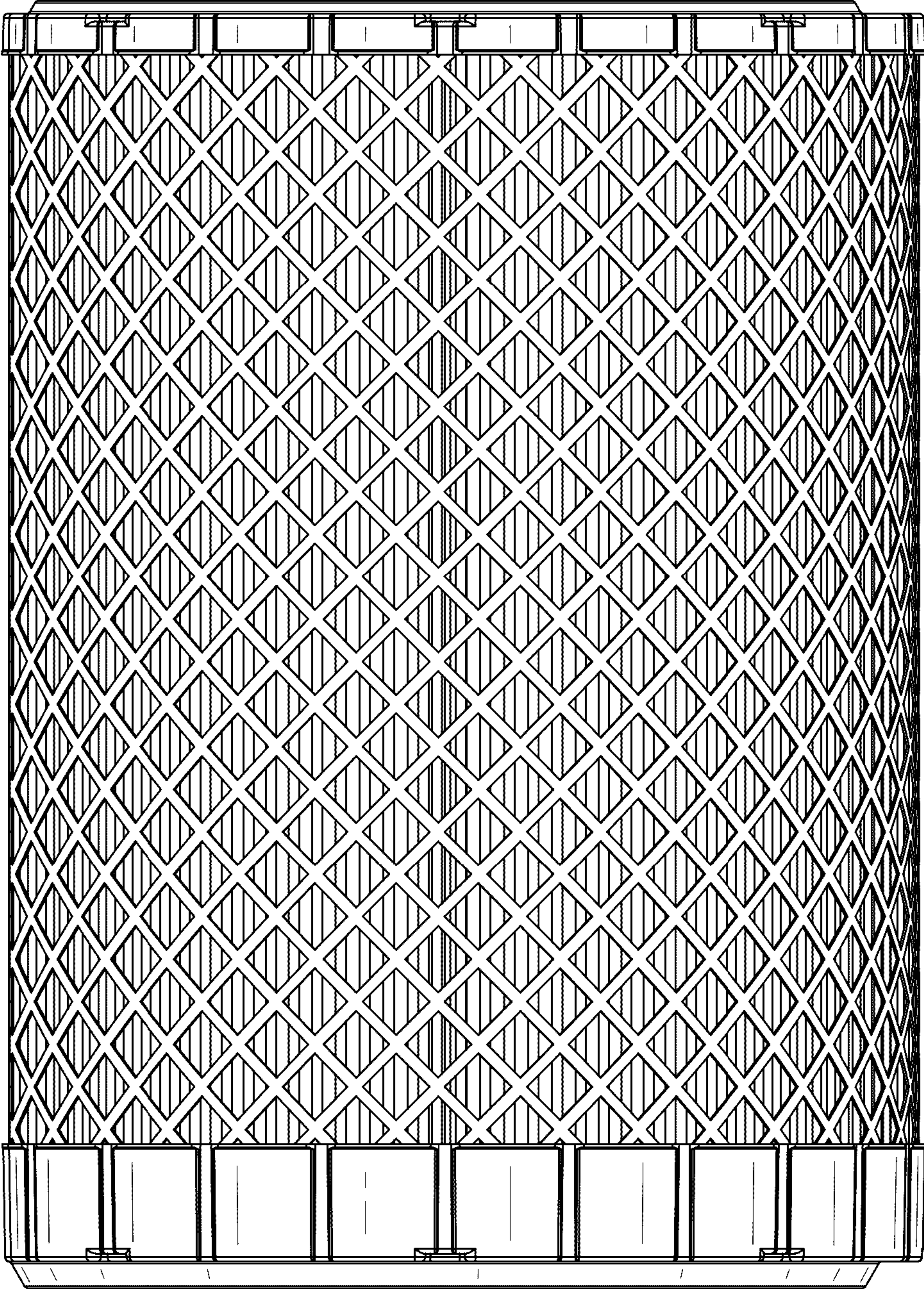

FIG. 5

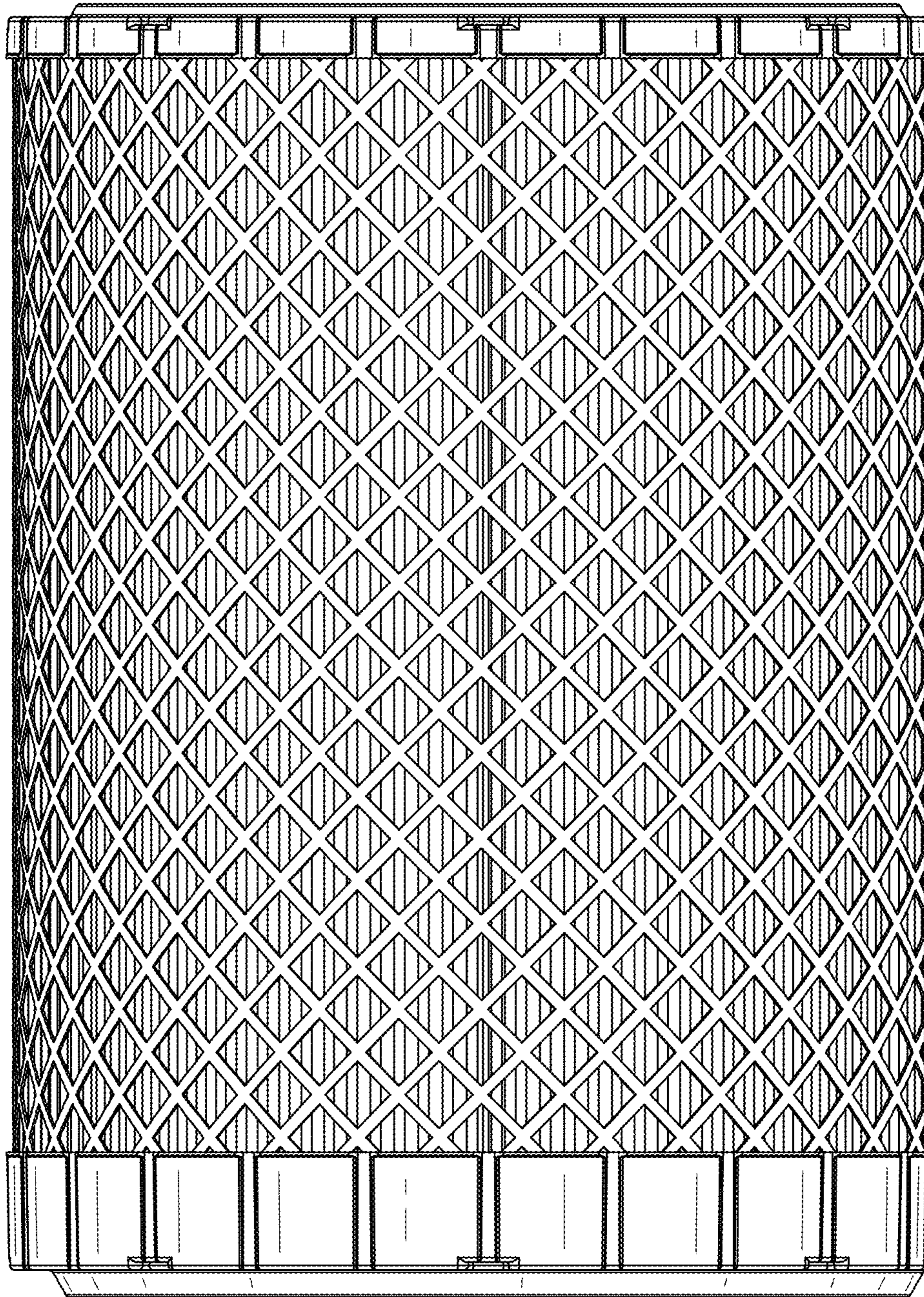

FIG. 6

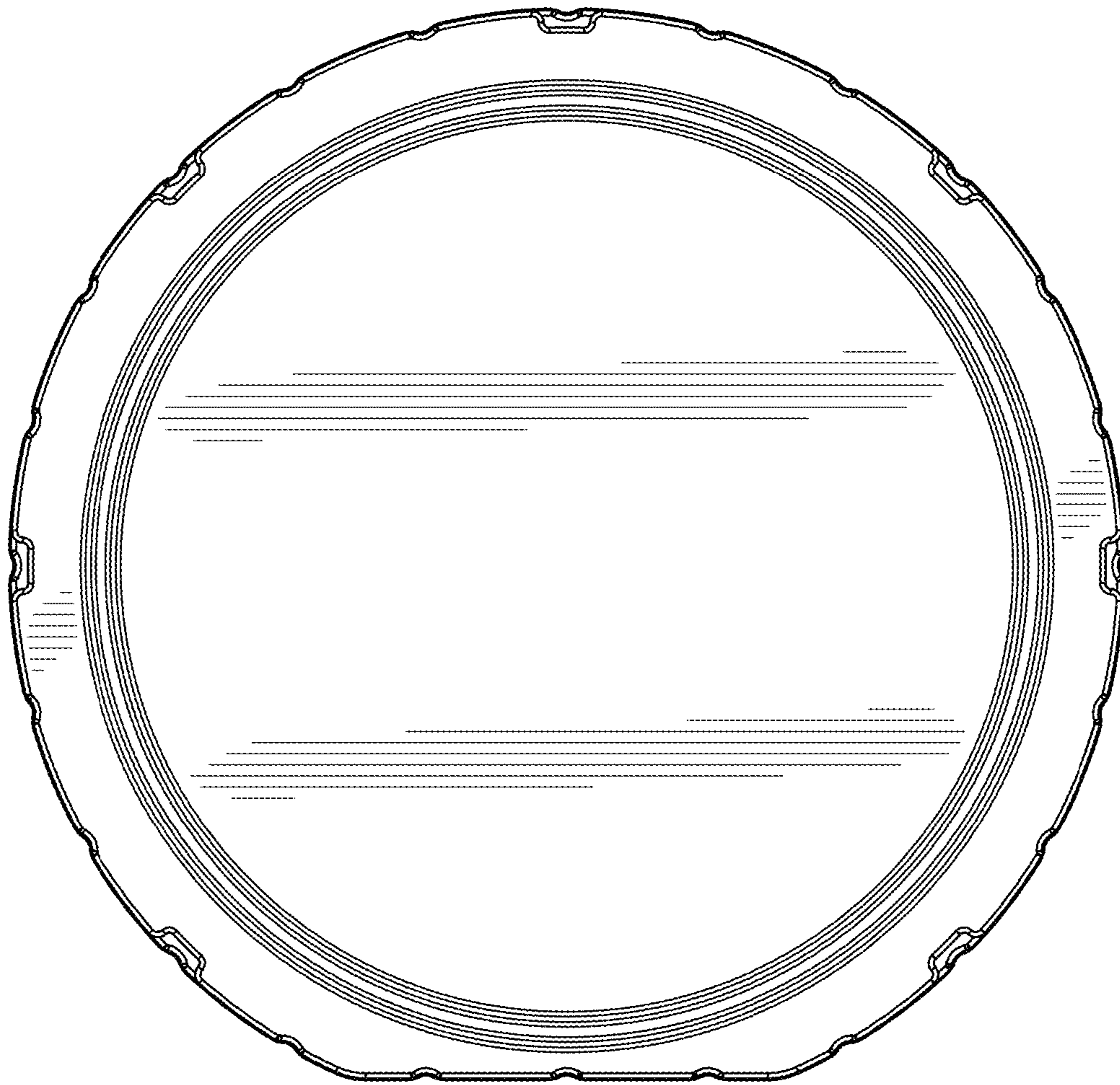

FIG. 7

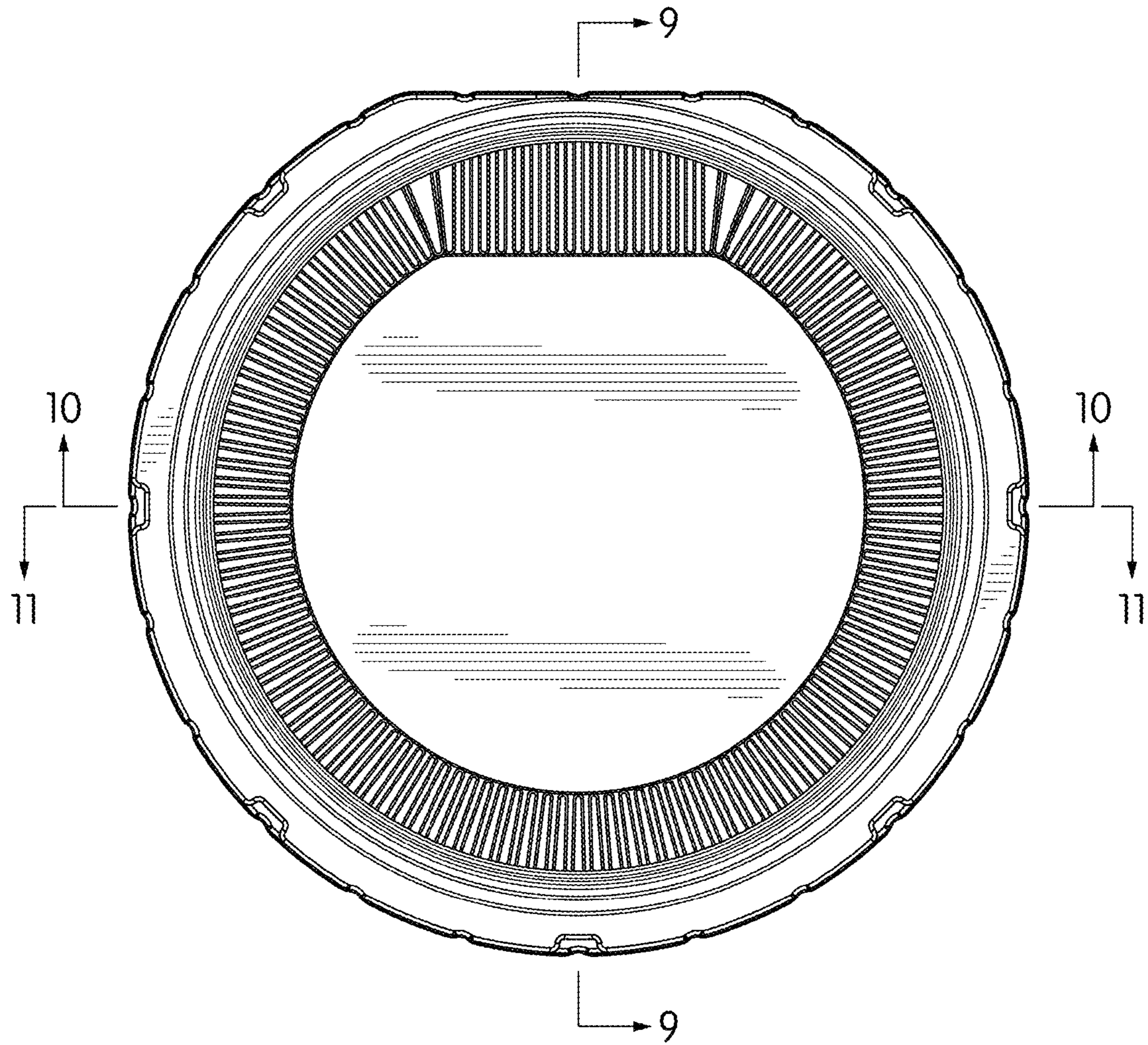

FIG. 8

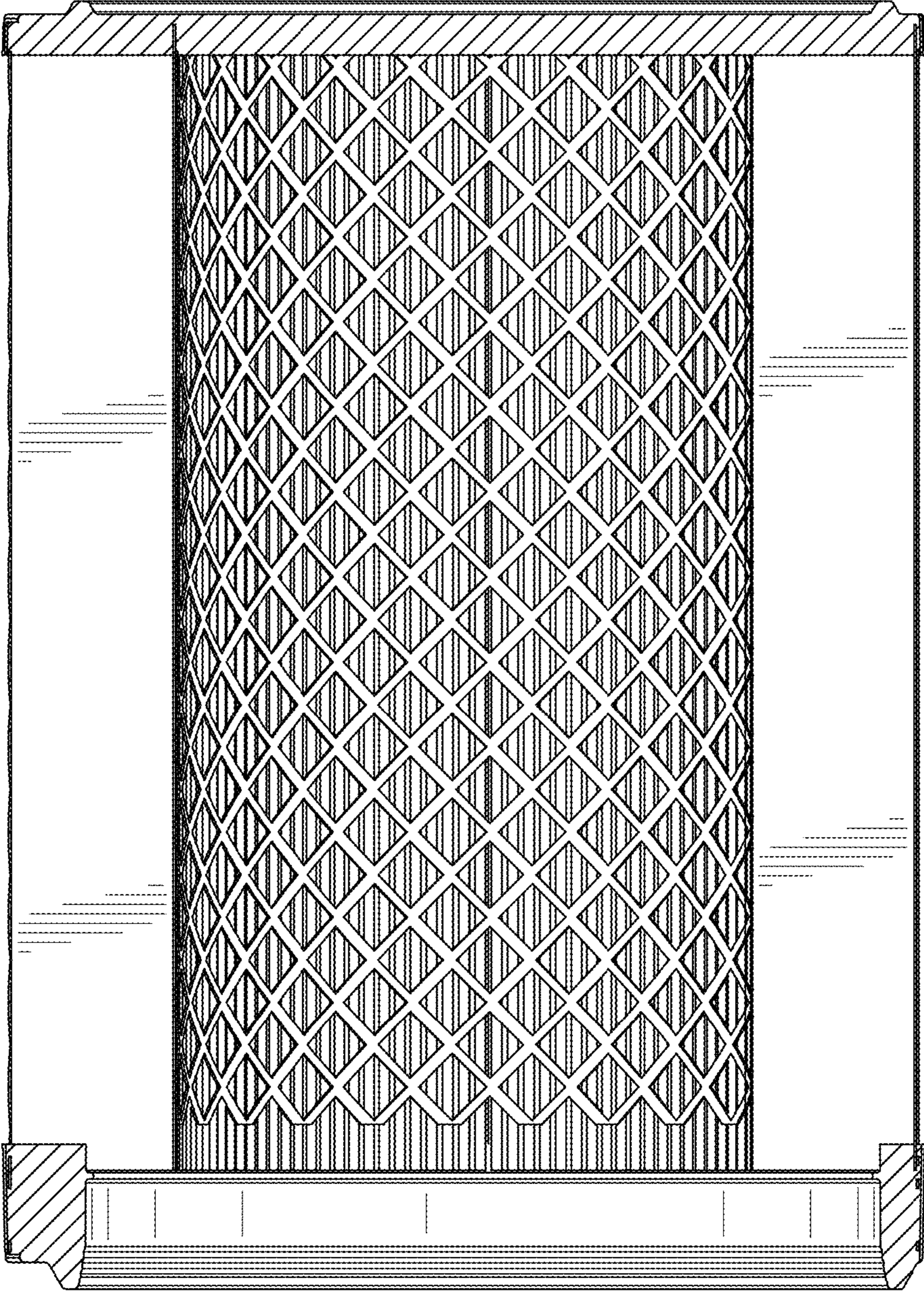

FIG. 9

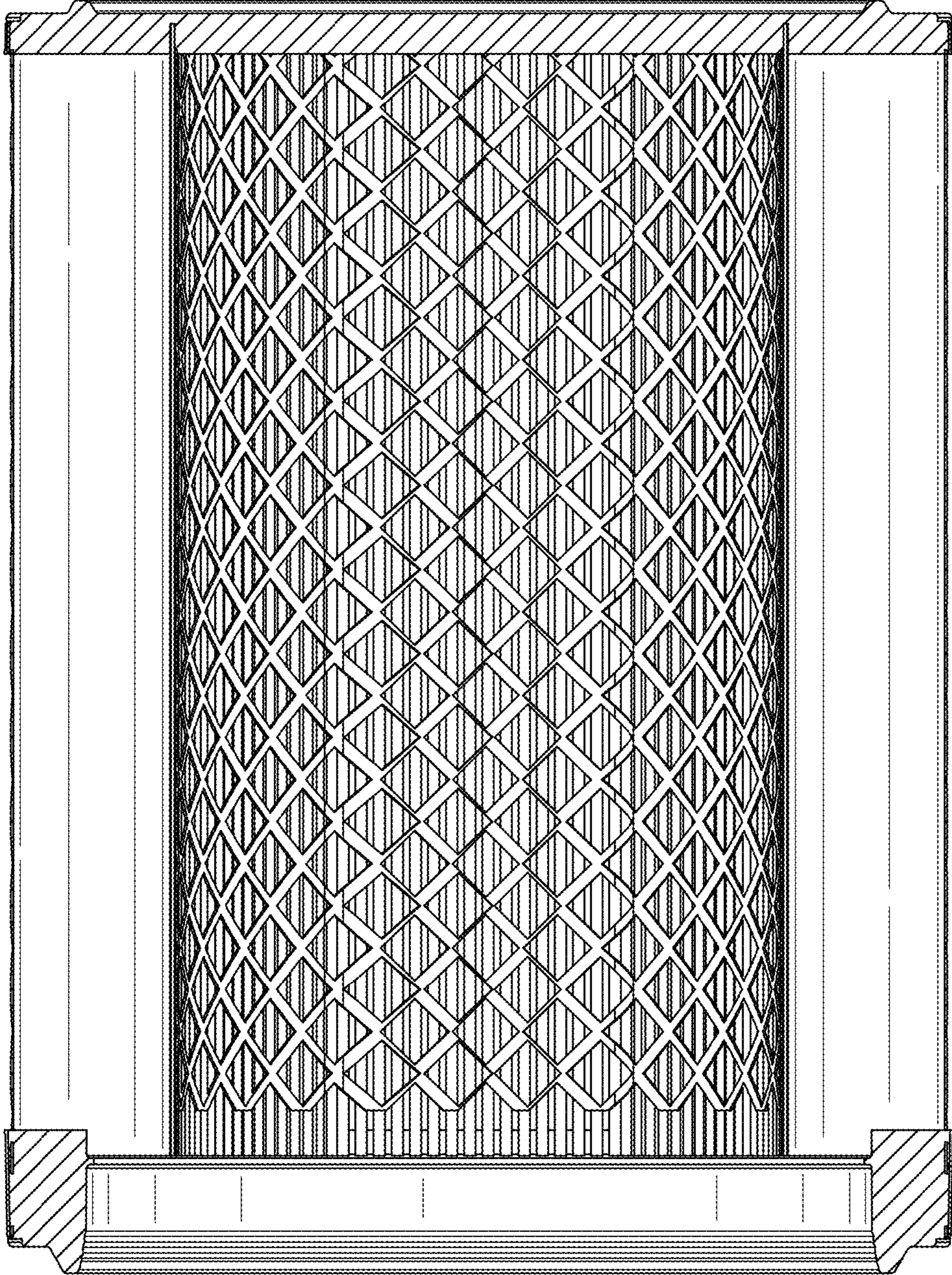

FIG. 10

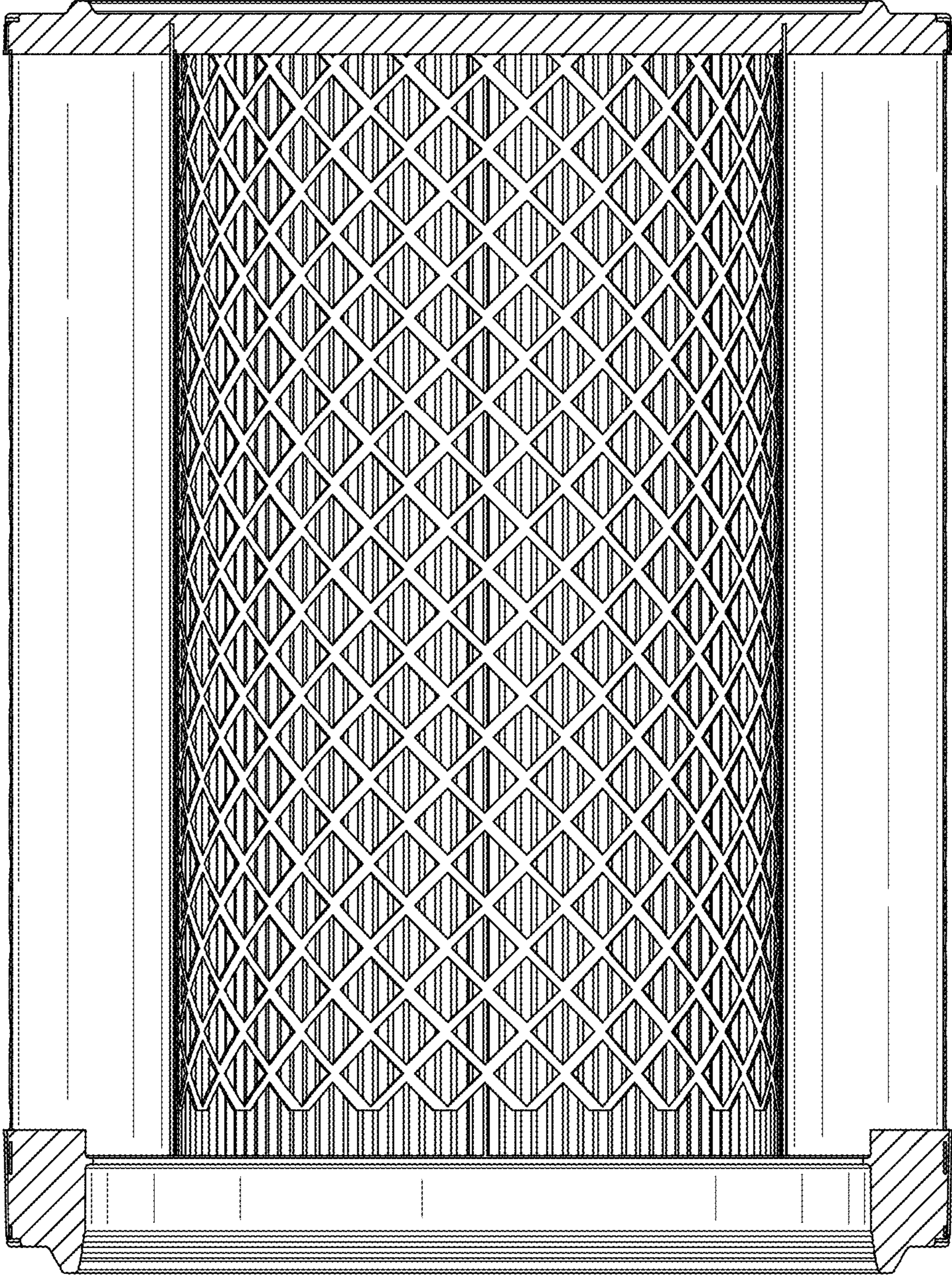

FIG. 11

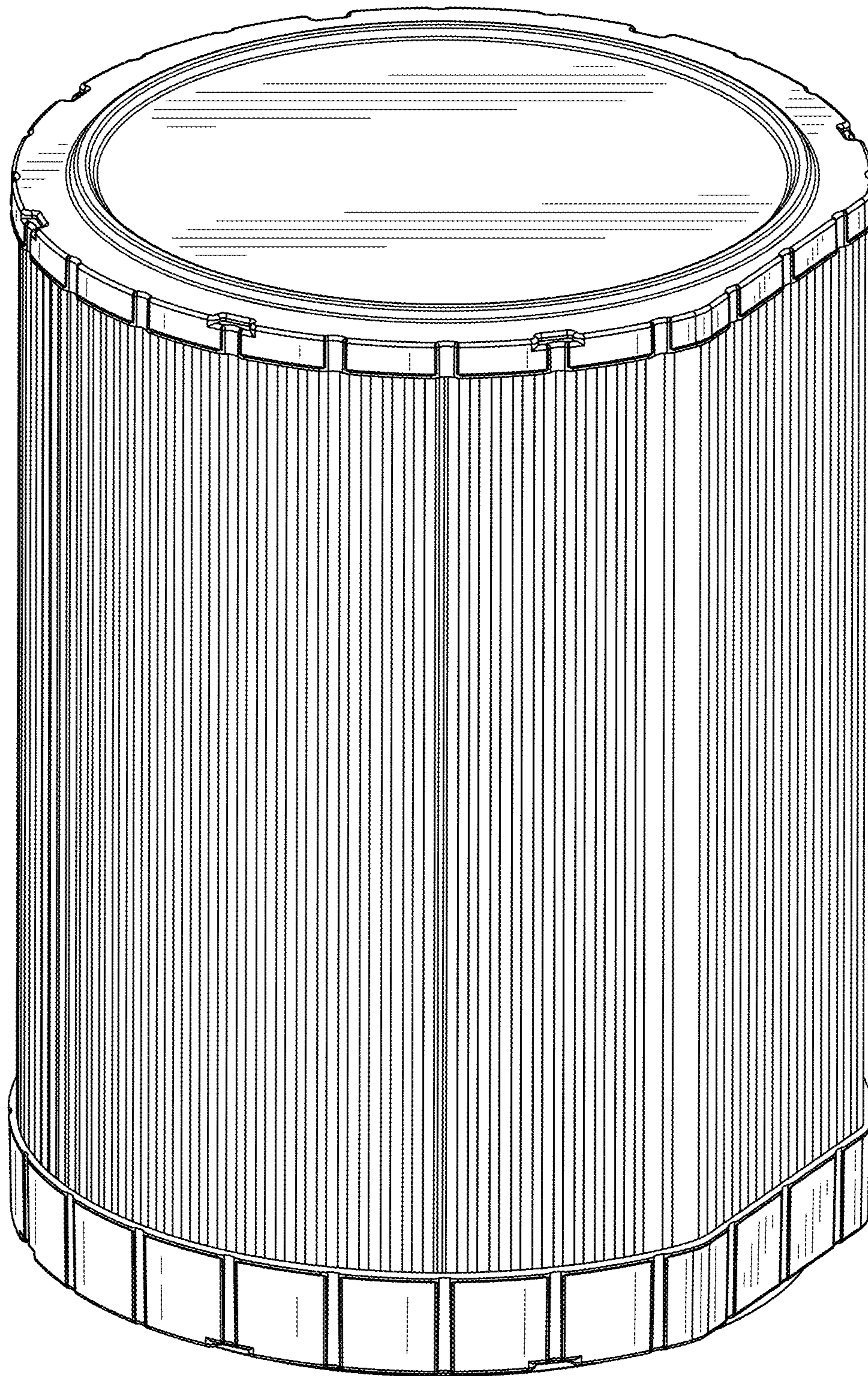

FIG. 12

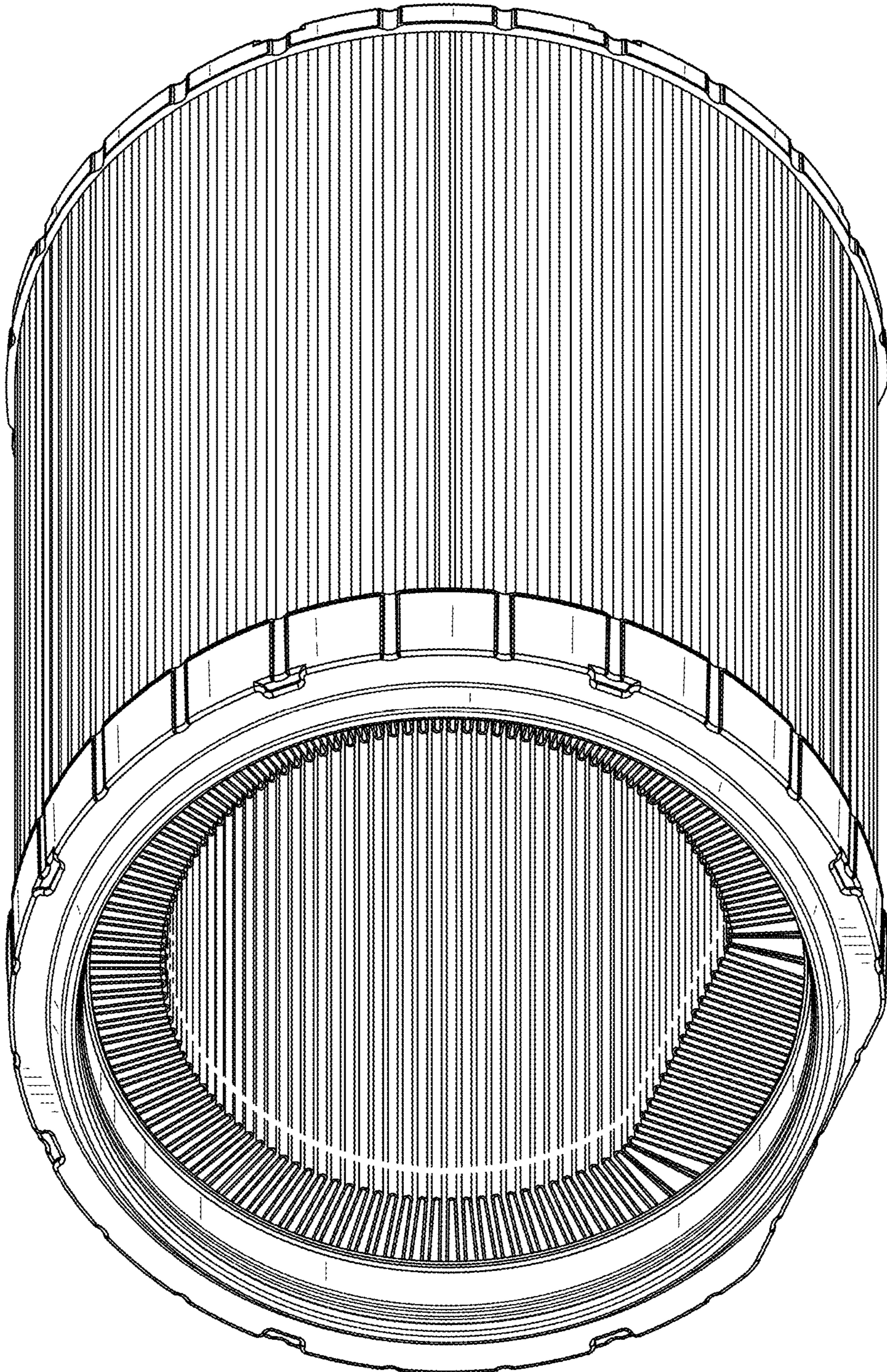

FIG. 13

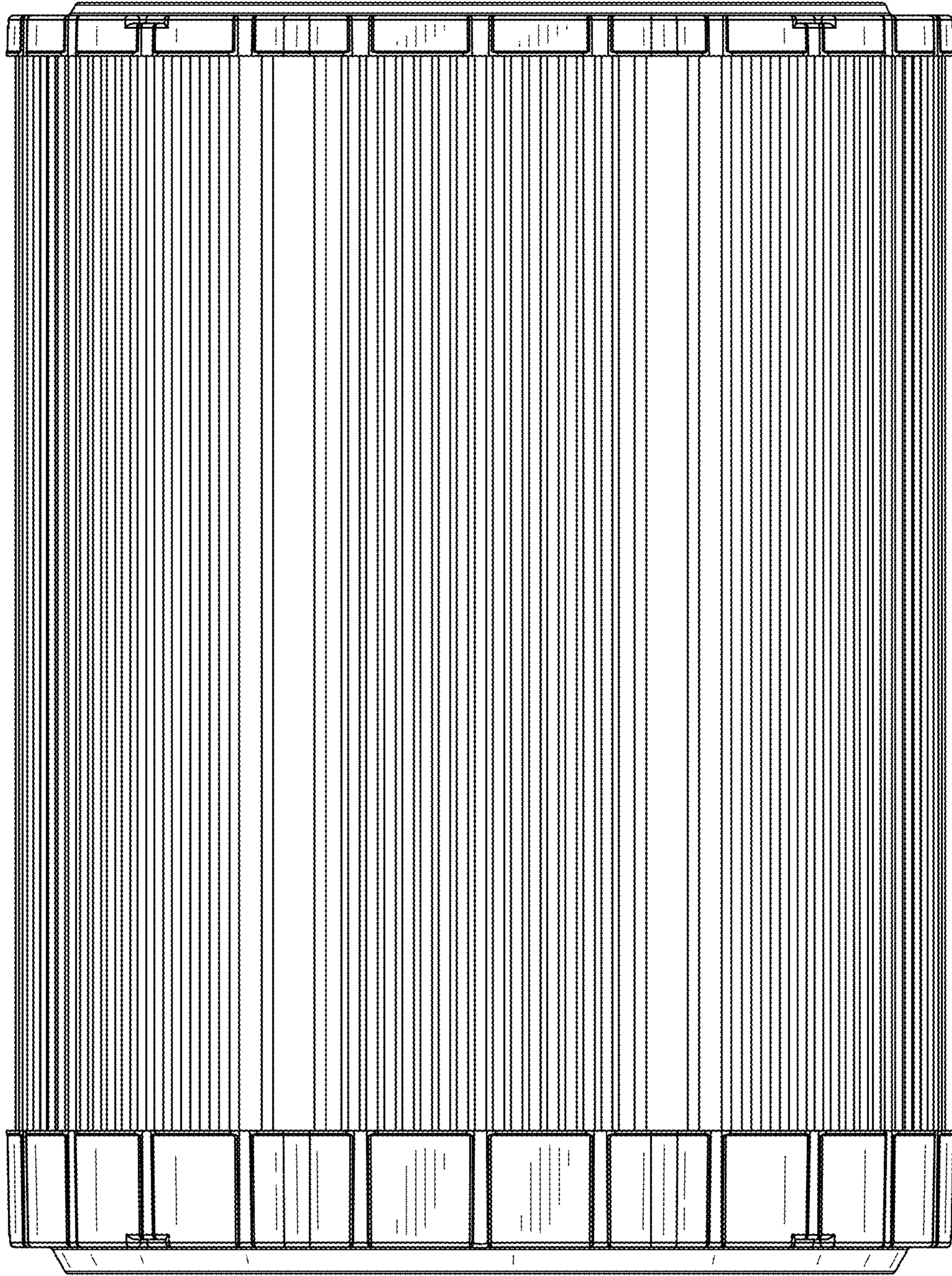

FIG. 14

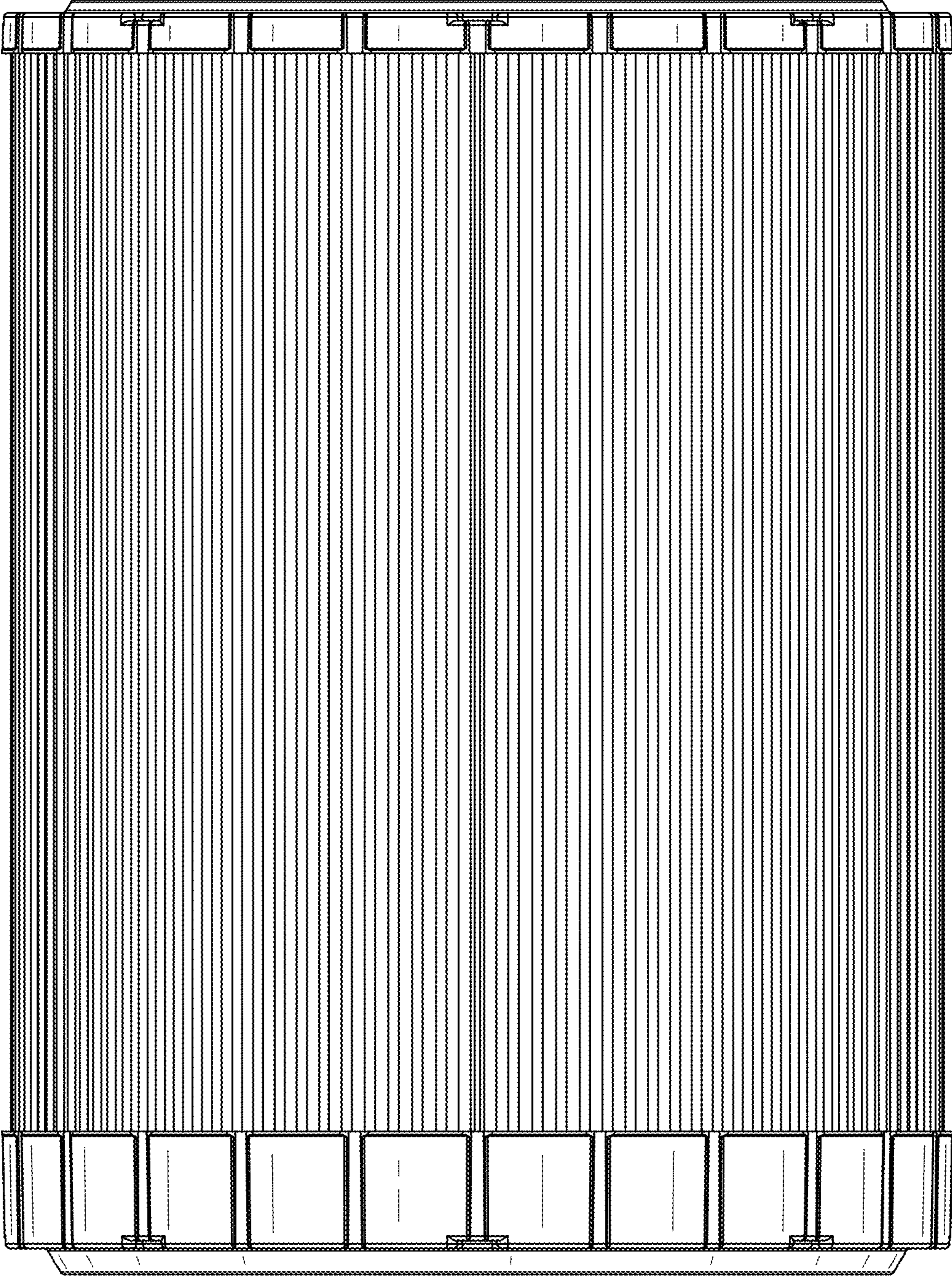

FIG. 15

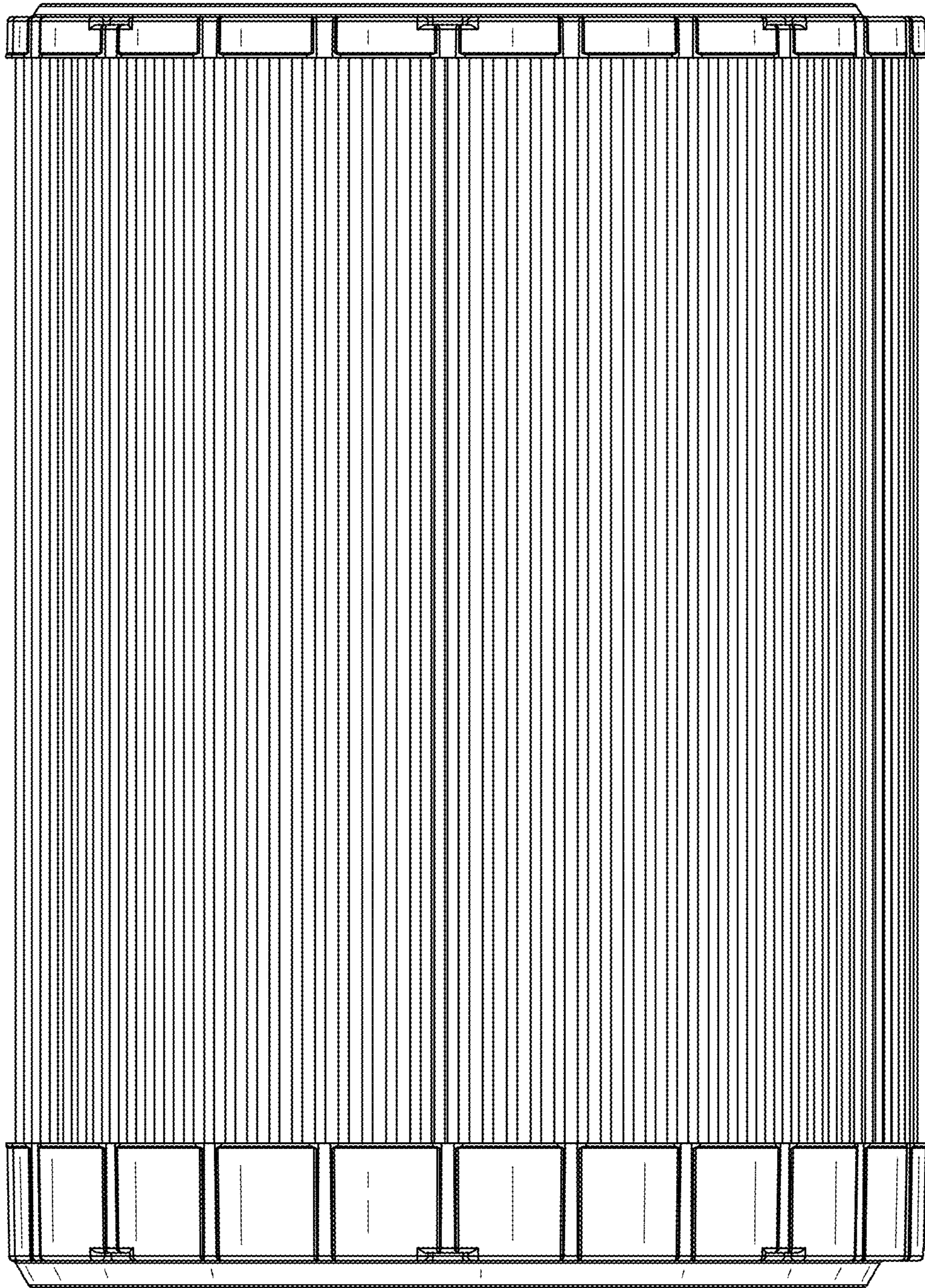

FIG. 16

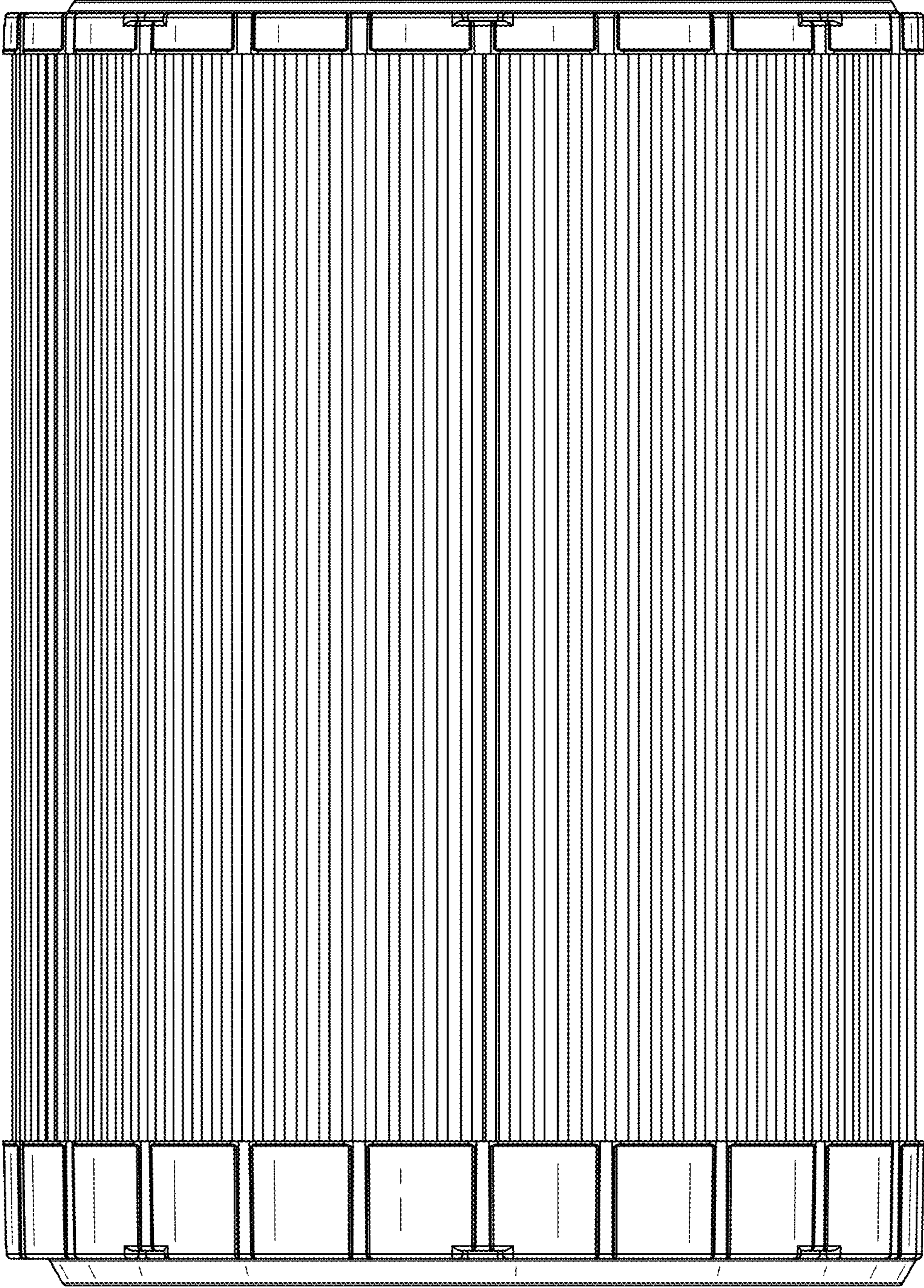

FIG. 17

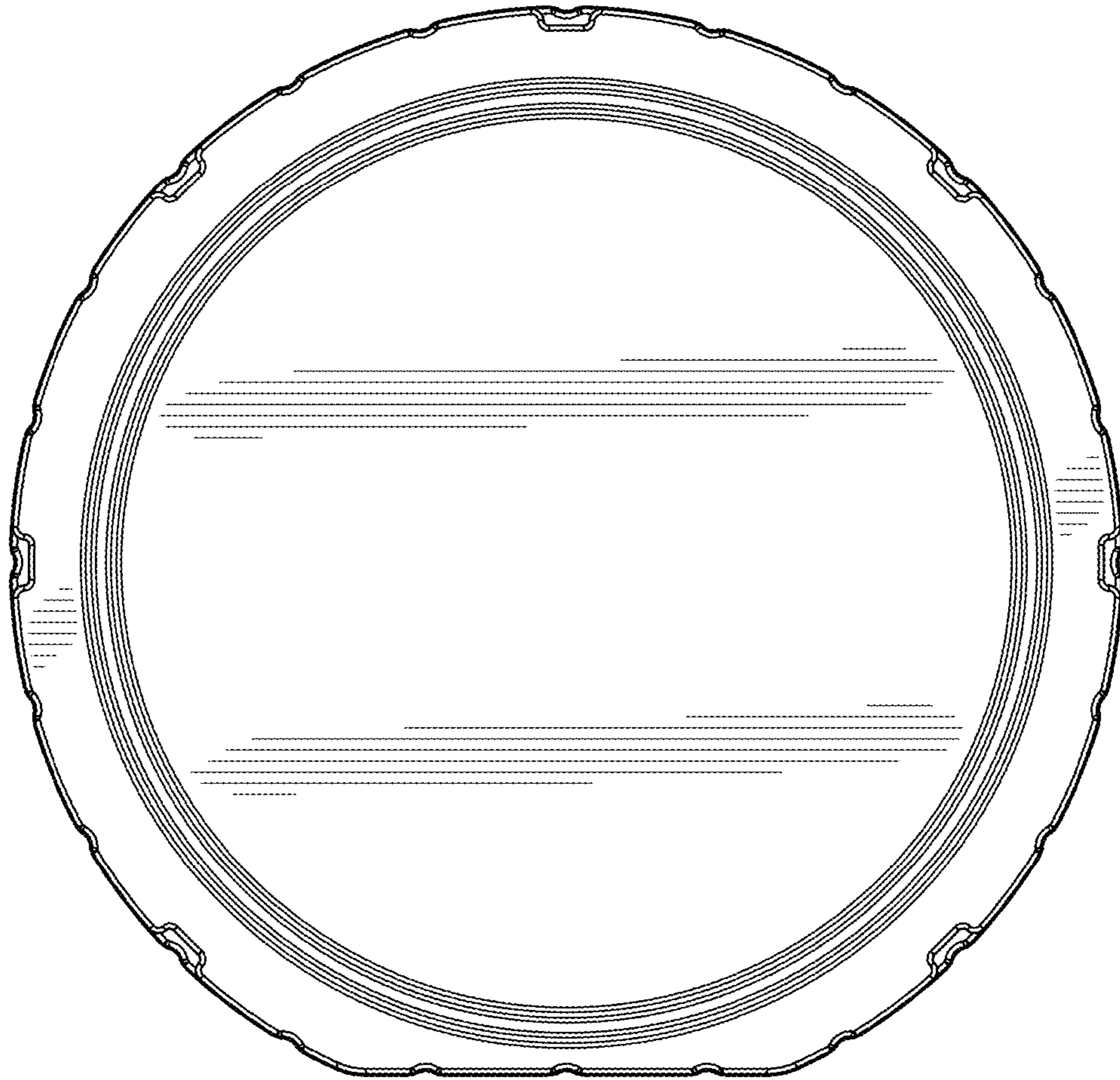

FIG. 18

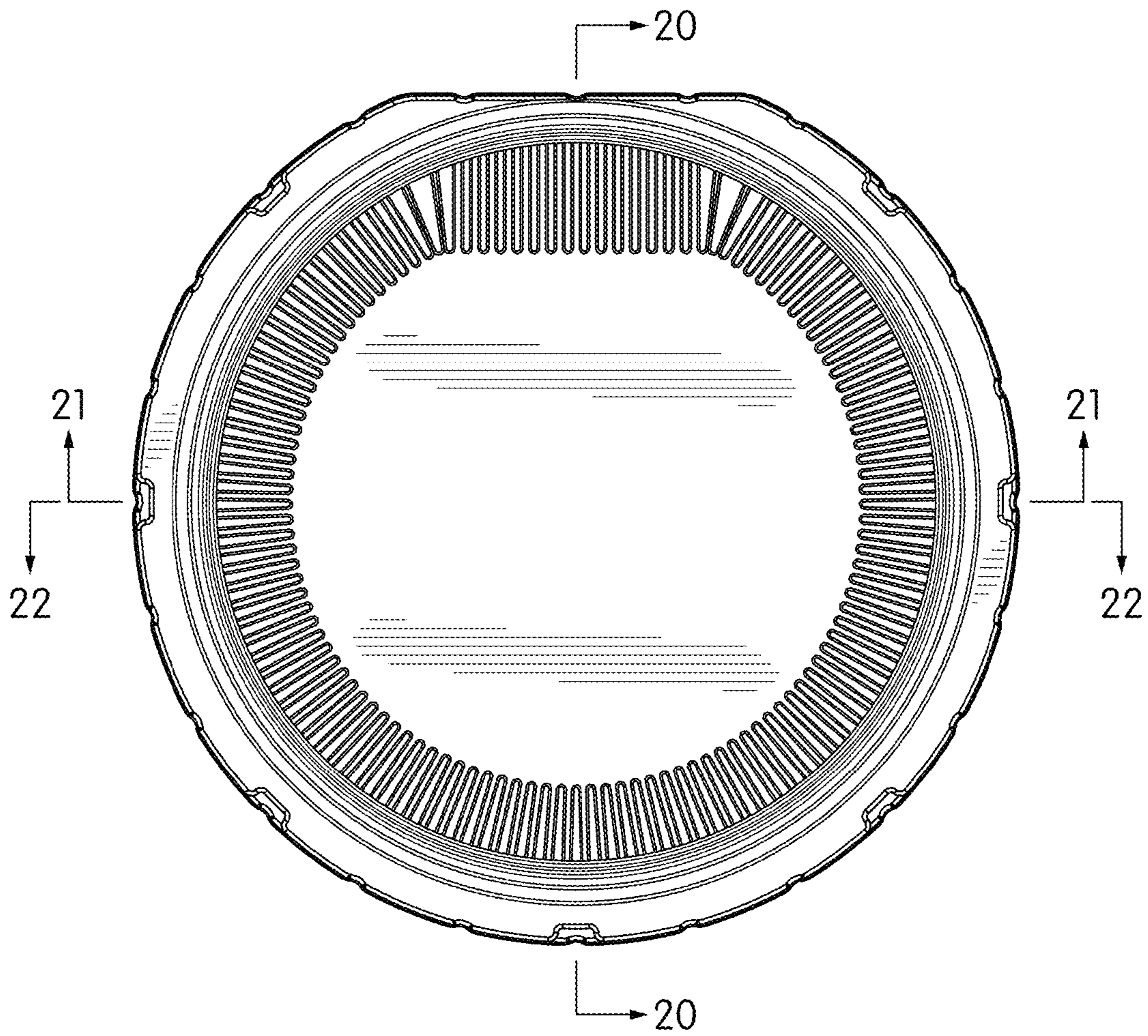

FIG. 19

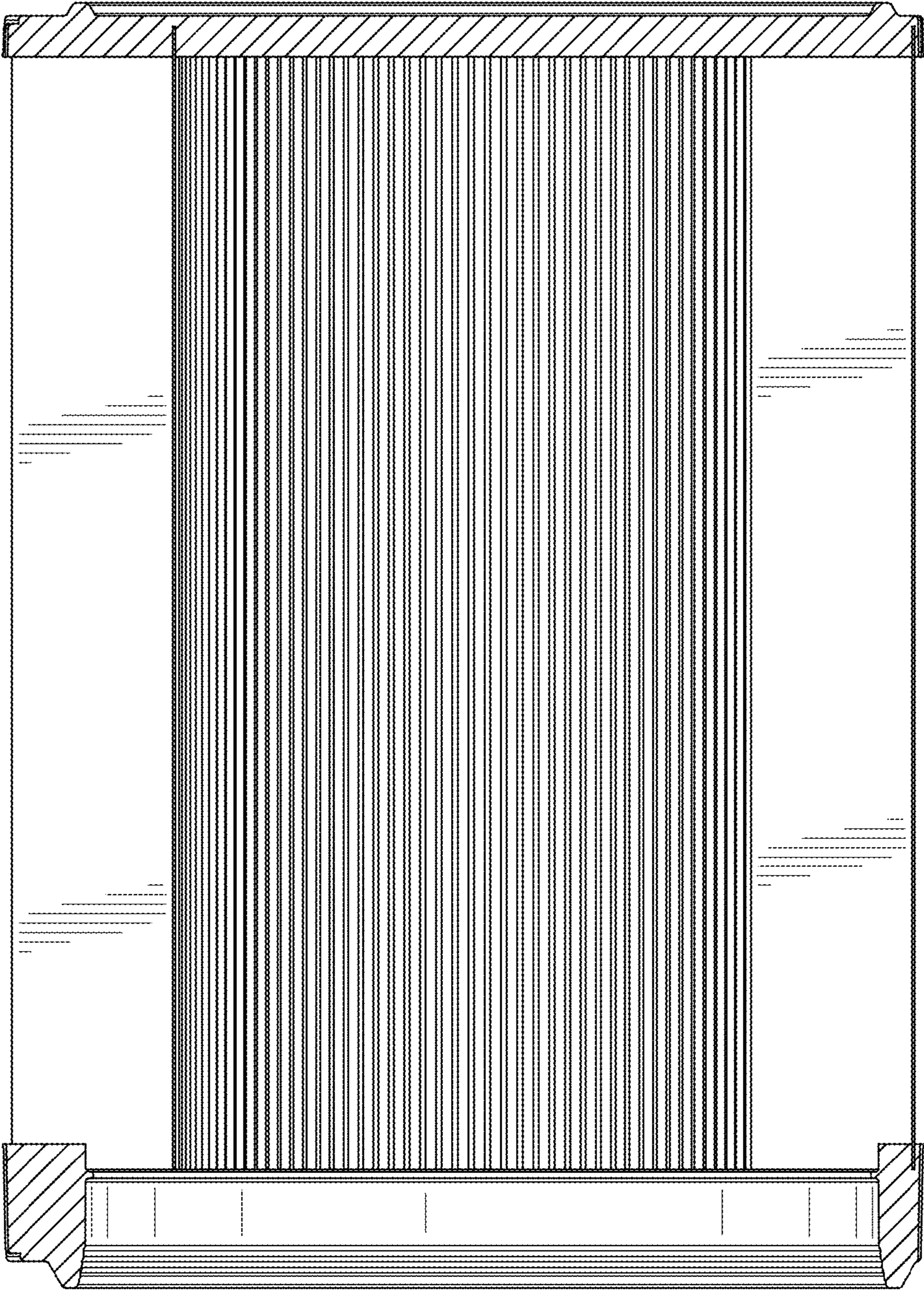

FIG. 20

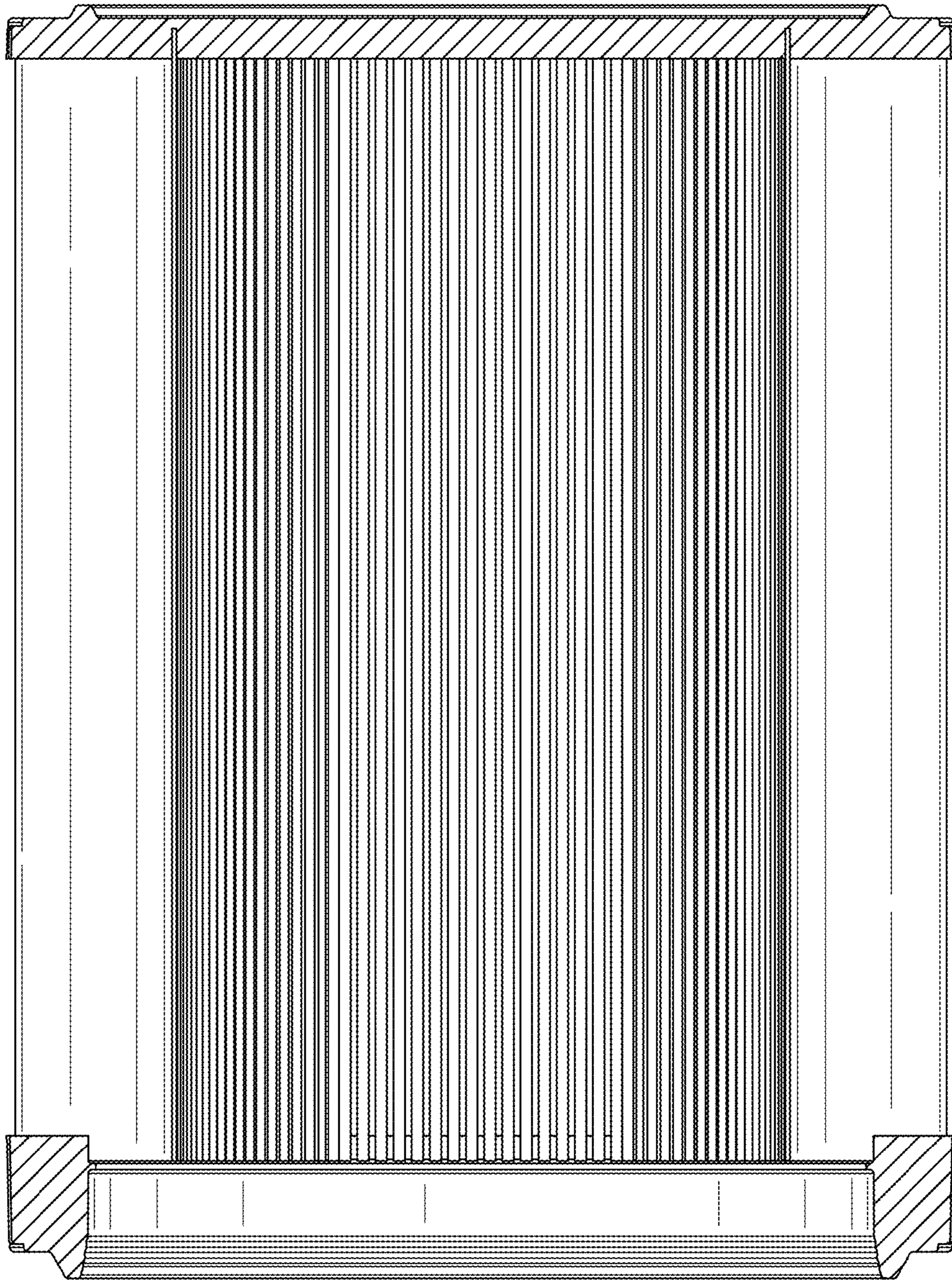

FIG. 21

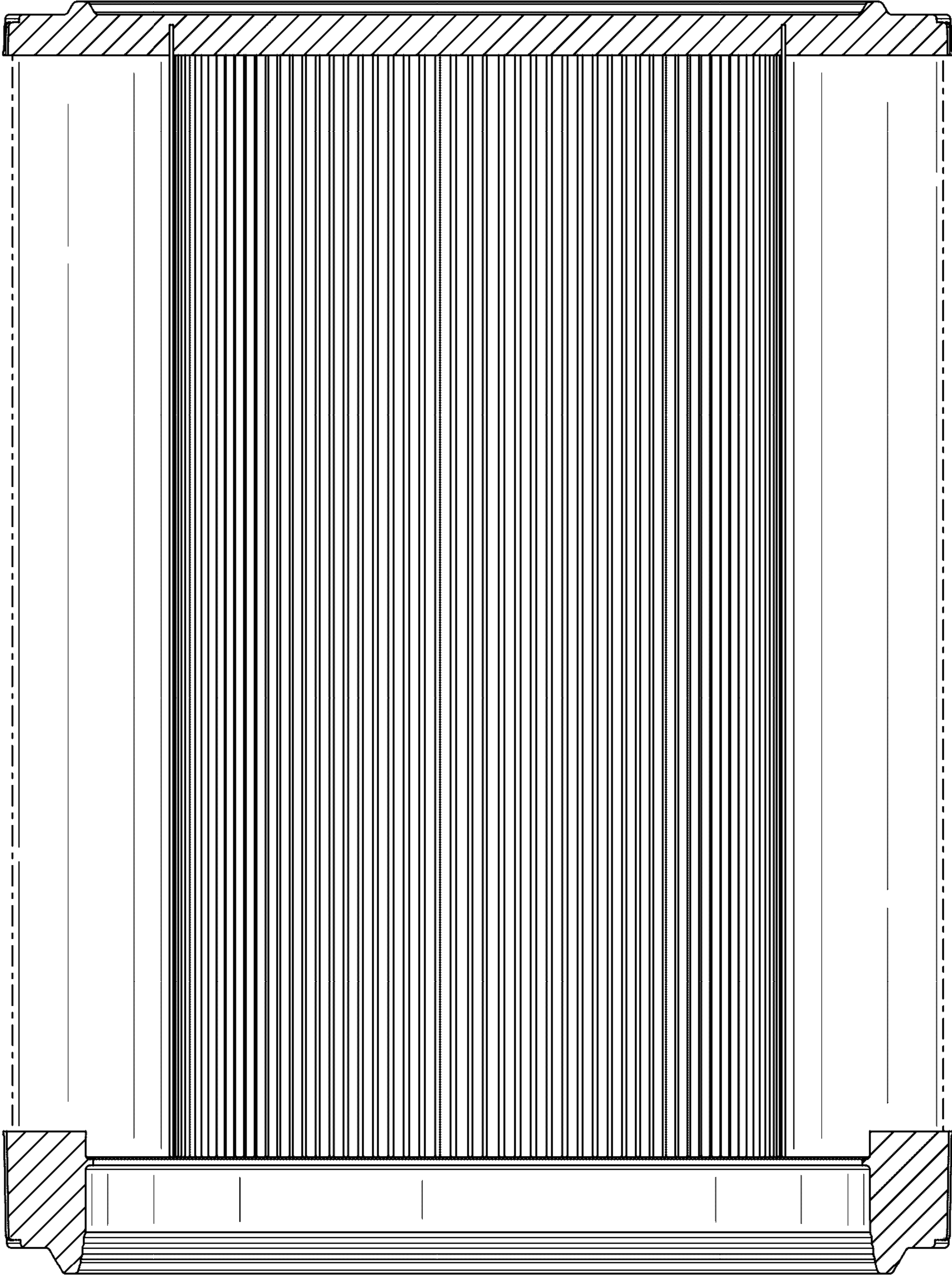

FIG. 22