



US00D770532S

(12) **United States Design Patent** (10) **Patent No.:** **US D770,532 S**  
**Nuovo et al.** (45) **Date of Patent:** **\*\* \*Nov. 1, 2016**

(54) **DISPLAY SCREEN OR PORTION THEREOF WITH ANIMATED GRAPHICAL USER INTERFACE**

(71) Applicant: **Samsung Electronics Co., Ltd.**, Suwon-si (KR)

(72) Inventors: **Frank Nuovo**, Los Angeles, CA (US); **Gerardo Herrera**, Agoura Hills, CA (US); **Jay Christopher Lopez**, Los Angeles, CA (US); **Helder Humberto Pereira Correia**, Sunnyvale, CA (US)

(73) Assignee: **SAMSUNG ELECTRONICS CO., LTD.**, Suwon-Si (KR)

(\*) Notice: This patent is subject to a terminal disclaimer.

(\*\*) Term: **14 Years**

(21) Appl. No.: **29/491,640**

(22) Filed: **May 22, 2014**

(51) **LOC (10) Cl.** ..... **14-04**

(52) **U.S. Cl.**

USPC ..... **D14/495**

(58) **Field of Classification Search**

USPC ..... D14/485-488

CPC ..... A61B 5/02; A61B 8/46; G06F 19/3406;

G06F 19/34; G06F 19/3418; G06F 3/04815;

G06F 2203/04802; G06F 3/0482; G06F

17/212; G06F 3/1251; G06F 3/048; G06F

3/0481; G06F 17/3005; G06F 17/30112;

G06F 17/30716; G06T 2207/30004; G06K

9/00671; H04N 1/00408; G06N 3/006

See application file for complete search history.

(56) **References Cited**

**U.S. PATENT DOCUMENTS**

D251,719 S \* 5/1979 Schmitz, Jr. .... D11/136

D402,132 S \* 12/1998 Gardner ..... D6/674.1

(Continued)

**OTHER PUBLICATIONS**

Top Rated Health and Fitness Apps for our Windows Phones, posted at WindowsCentral.com by George Ponder, posted Jul. 25, 2015, © 2015 Mobile Nations, [site visited Nov. 20, 2015]. Available from internet: <<http://www.windowscentral.com/top-rated-health-and-fitness-apps-windows-phone#slide3>>.\*

(Continued)

*Primary Examiner* — Karen E Kearney

*Assistant Examiner* — Alyse Joseph

(74) *Attorney, Agent, or Firm* — McAndrews Held & Malloy, Ltd.

(57) **CLAIM**

The ornamental design for a display screen or portion thereof with animated graphical user interface, as shown and described.

**DESCRIPTION**

FIG. 1 is the first image in a sequence for a display screen or portion thereof with animated graphical user interface showing our new design;

FIG. 2 is the second image thereof;

FIG. 3 is the third image thereof;

FIG. 4 is the fourth image thereof;

FIG. 5 is the fifth image thereof;

FIG. 6 is the sixth image thereof;

FIG. 7 is the seventh image thereof;

FIG. 8 is the eighth image thereof; and,

FIG. 9 is the ninth image thereof.

The even length dashed broken lines are for environmental purposes only and form no part of the claimed design.

The uneven length dash-dot broken lines of the display screen represent an unclaimed boundary line and form no part of the claimed design.

The appearance of the transitional image sequentially transitions between the images shown in FIGS. 1-9. The subject matter in this patent includes a process or period in which an image changes into another image. This process or period forms no part of the claimed design.

**1 Claim, 9 Drawing Sheets**

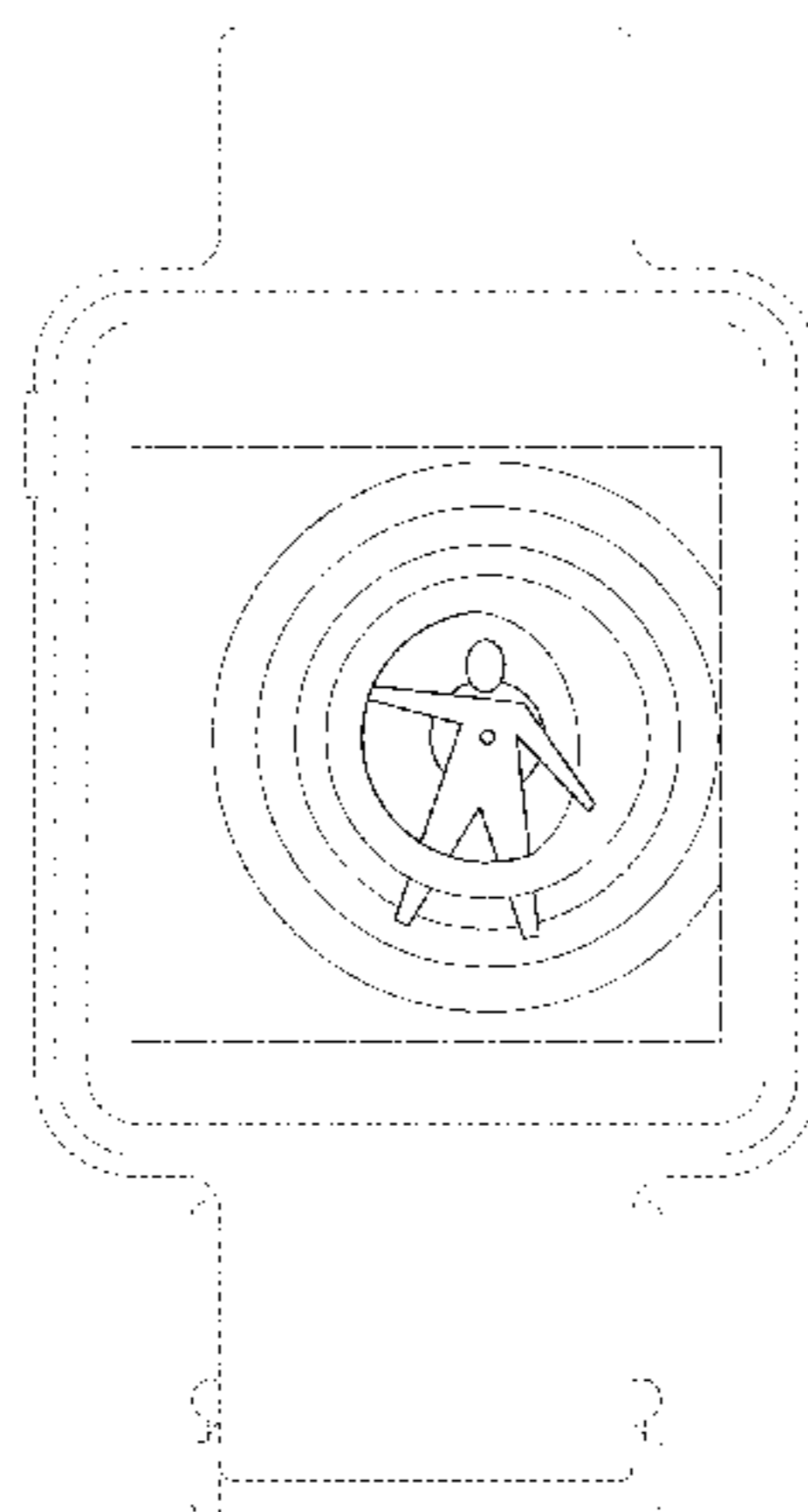
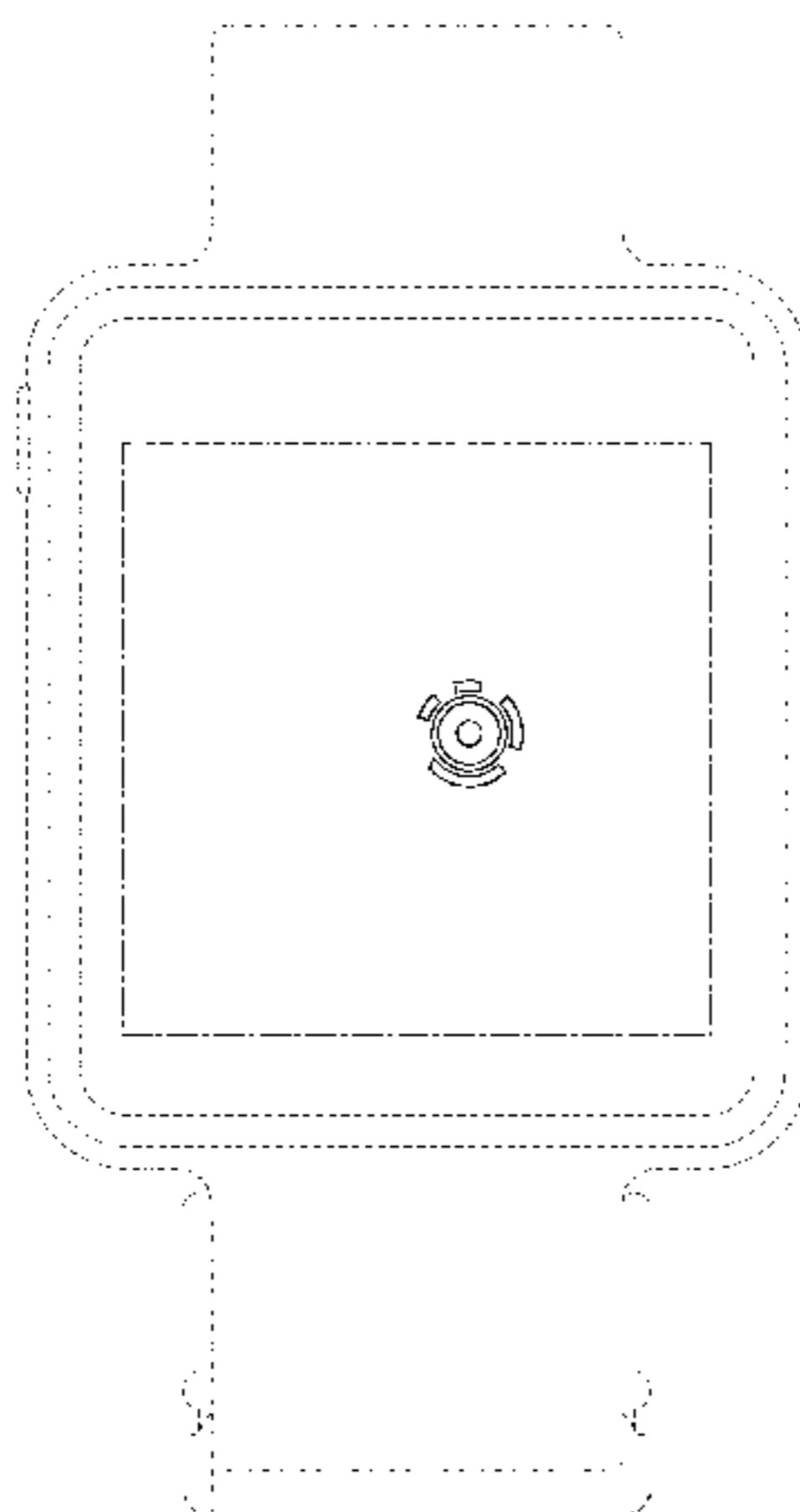

(56)

References Cited

U.S. PATENT DOCUMENTS

D458,178 S \* 6/2002 Bradshaw ..... D10/114.1  
 D566,844 S \* 4/2008 Inose ..... D24/165  
 D575,871 S \* 8/2008 Wawro ..... D24/165  
 D577,385 S \* 9/2008 Sand ..... D19/91  
 D645,261 S \* 9/2011 Puskas ..... D6/303  
 D679,813 S \* 4/2013 Ashkenazi ..... D24/167  
 D687,858 S \* 8/2013 Reeves ..... D14/491  
 D689,874 S \* 9/2013 Brinda ..... D14/485  
 D694,595 S \* 12/2013 Slocum ..... D7/698  
 D707,292 S \* 6/2014 Krause ..... D19/59  
 8,775,120 B2 \* 7/2014 Molettiere ..... A61B 5/0002  
 702/160  
 8,793,618 B2 \* 7/2014 Martin ..... G06F 19/3406  
 715/774  
 D711,278 S \* 8/2014 Kadri ..... D11/56  
 8,855,757 B2 \* 10/2014 Kapoor ..... A61B 5/0432  
 600/523  
 D721,086 S \* 1/2015 Hontz, Jr. .... D14/485  
 D725,480 S \* 3/2015 Lipman ..... D9/418  
 D725,547 S \* 3/2015 Agule ..... D11/157  
 9,021,397 B2 \* 4/2015 Ramsay ..... G06T 11/00  
 715/762  
 9,026,927 B2 \* 5/2015 Brumback ..... A61B 5/0015  
 715/764  
 9,049,993 B2 \* 6/2015 Tanishima ..... A61B 5/0205  
 9,066,659 B2 \* 6/2015 Thakur ..... A61B 5/0031  
 D736,792 S \* 8/2015 Brinda ..... D14/485  
 9,144,382 B2 \* 9/2015 Nazarian ..... A61B 5/7203

D740,301 S \* 10/2015 Soegiono ..... D14/485  
 D741,063 S \* 10/2015 Broyles ..... D3/271.1  
 D741,722 S \* 10/2015 Oaknin ..... D9/629  
 9,149,187 B2 \* 10/2015 Subramaniam ..... A61B 5/0002  
 9,162,032 B2 \* 10/2015 Lynch, Jr. .... A61M 16/00  
 D742,917 S \* 11/2015 Perez ..... D14/492  
 9,173,567 B2 \* 11/2015 Jain ..... G06F 19/3418  
 2015/0304020 A1 \* 10/2015 Rebec ..... H04H 20/74  
 370/316

OTHER PUBLICATIONS

Fitbit Surge, posted at Fitbit.com, posted May 11, 2015, © 2015 Fitbit Inc., [site visited Nov. 20, 2015]. Available from internet: <<https://www.fitbit.com/surge>>.\*  
 MotiFIT Run, posted at iTunes.apple.com by Sylvio LeBlanc, posting date not posted, © 2015 Apple Inc., [site visited Nov. 20, 2015]. Available from internet: <<https://itunes.apple.com/us/app/motifit-run-running-jogging/id983858551?mt=8>>.\*  
 For Gadget Lovers: The Fitbit vs Polar Heart Rate Monitor, posted at AngiedeBorja.com by Angie deBorja, posted Sep. 19, 2013, © 2015 Angie deBorja Fitness, [site visited Nov. 20, 2015]. Available from internet: <<http://angiedeborja.com/gadget-lovers-fit-bit-versus-polar-heart-rate-monitor-compare/>>.\*  
 Apple Watch, posted at ThoughtTandoor.com, posting date not posted, © 2015, [site visited Jun. 8, 2016]. Available from internet: <<http://www.thoughttandoor.com/apple-watch.html>>.\*

\* cited by examiner

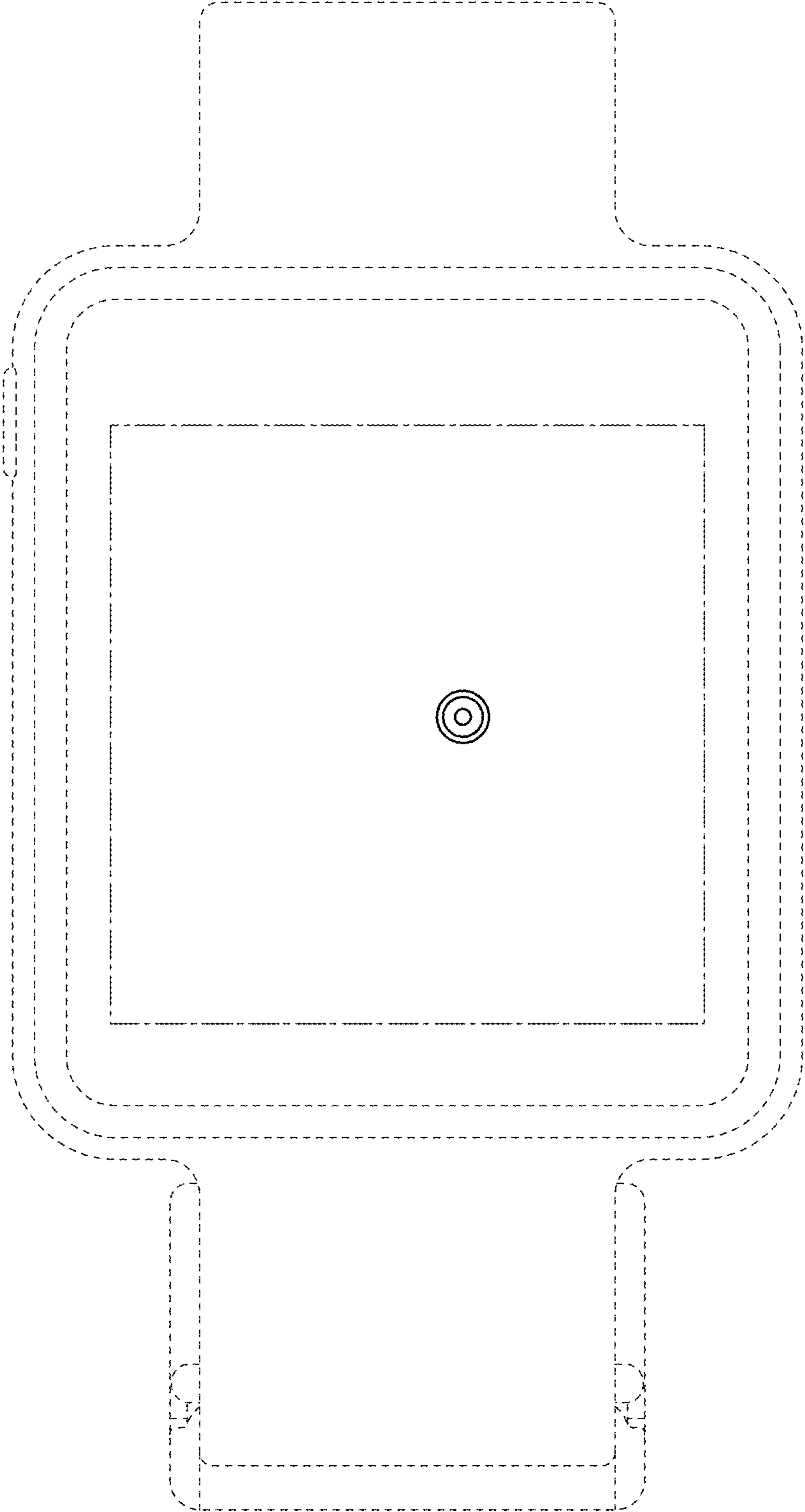

FIG. 1

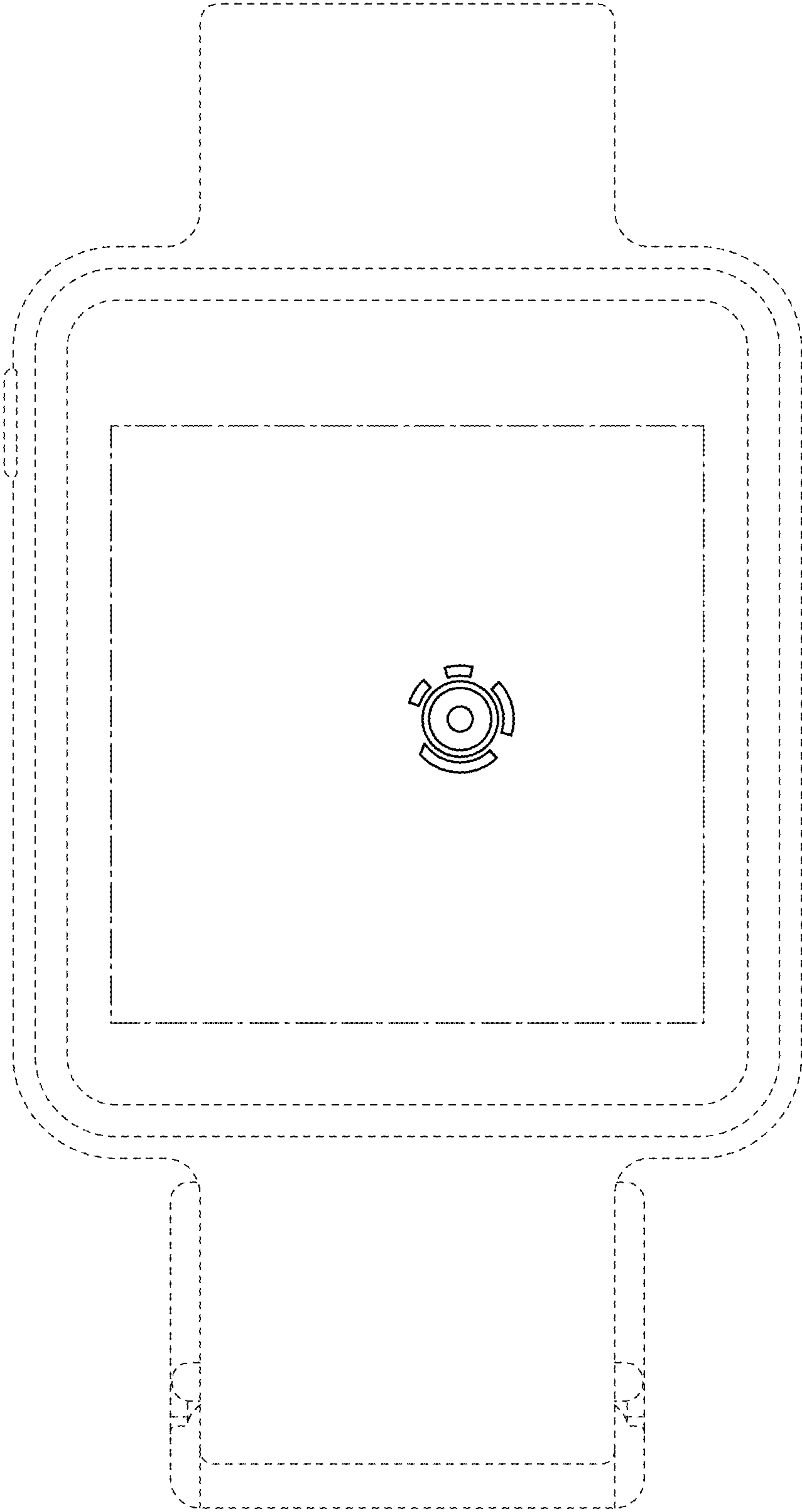

FIG. 2

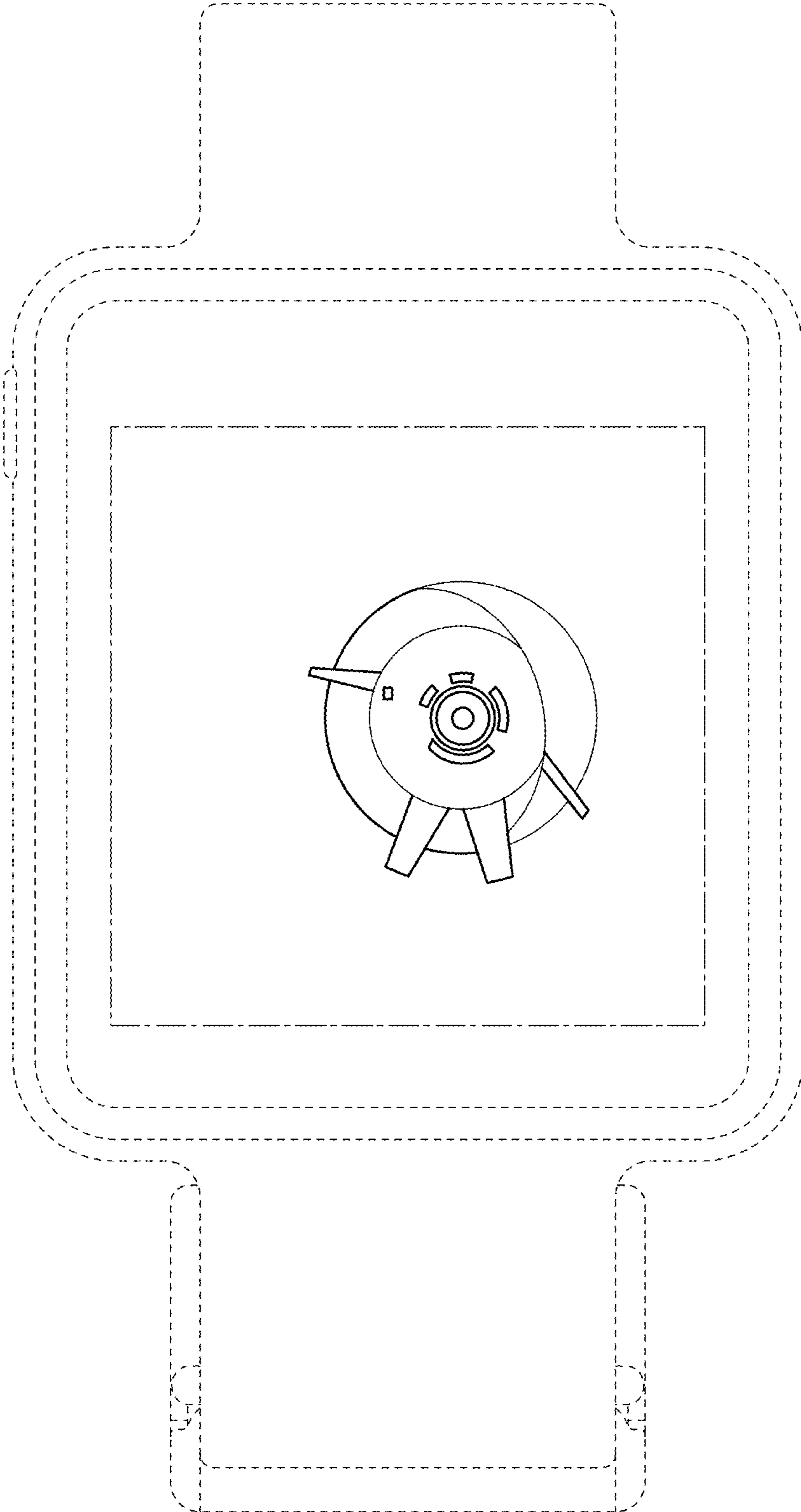

FIG. 3



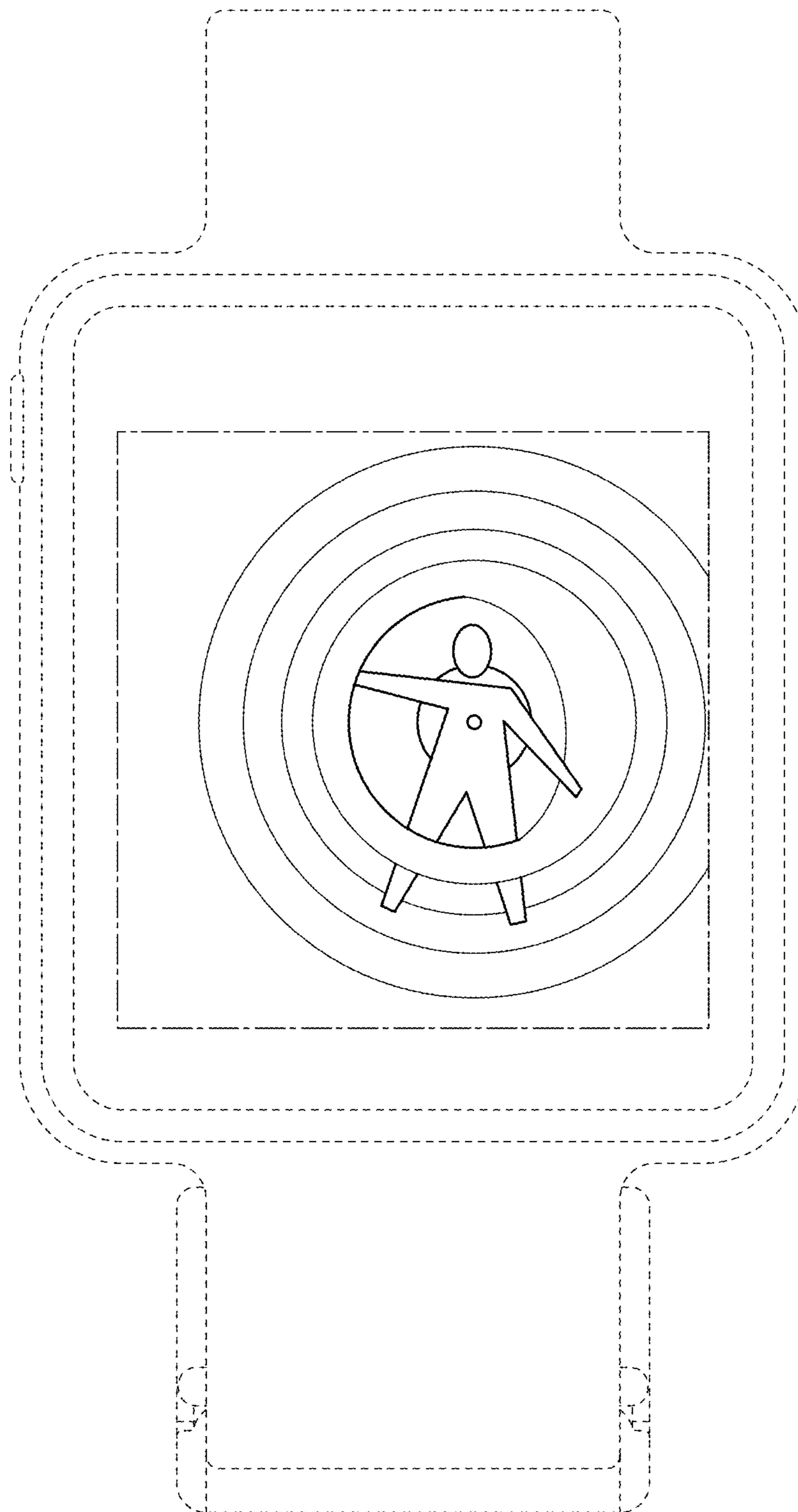

FIG. 4

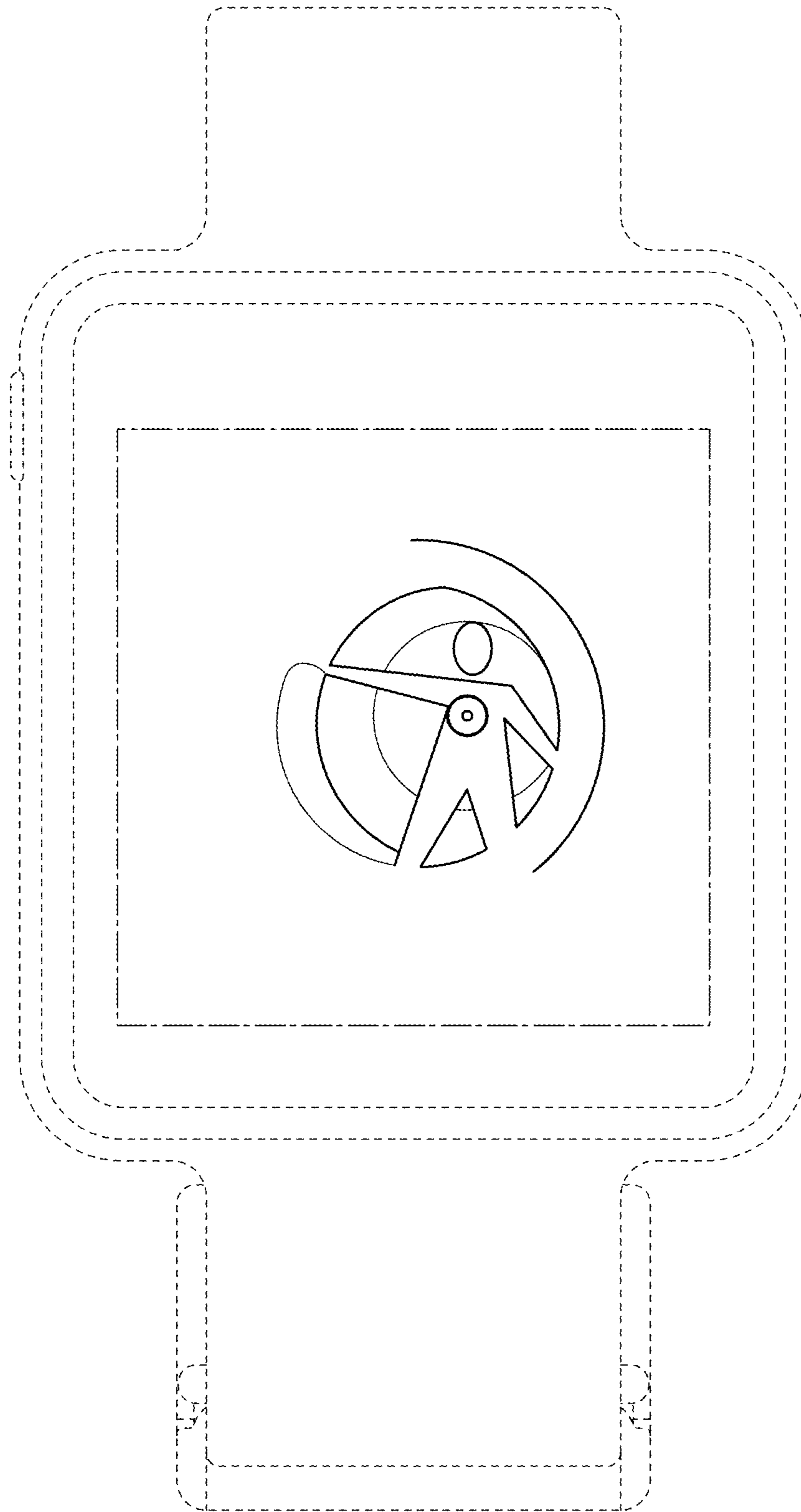

FIG. 5

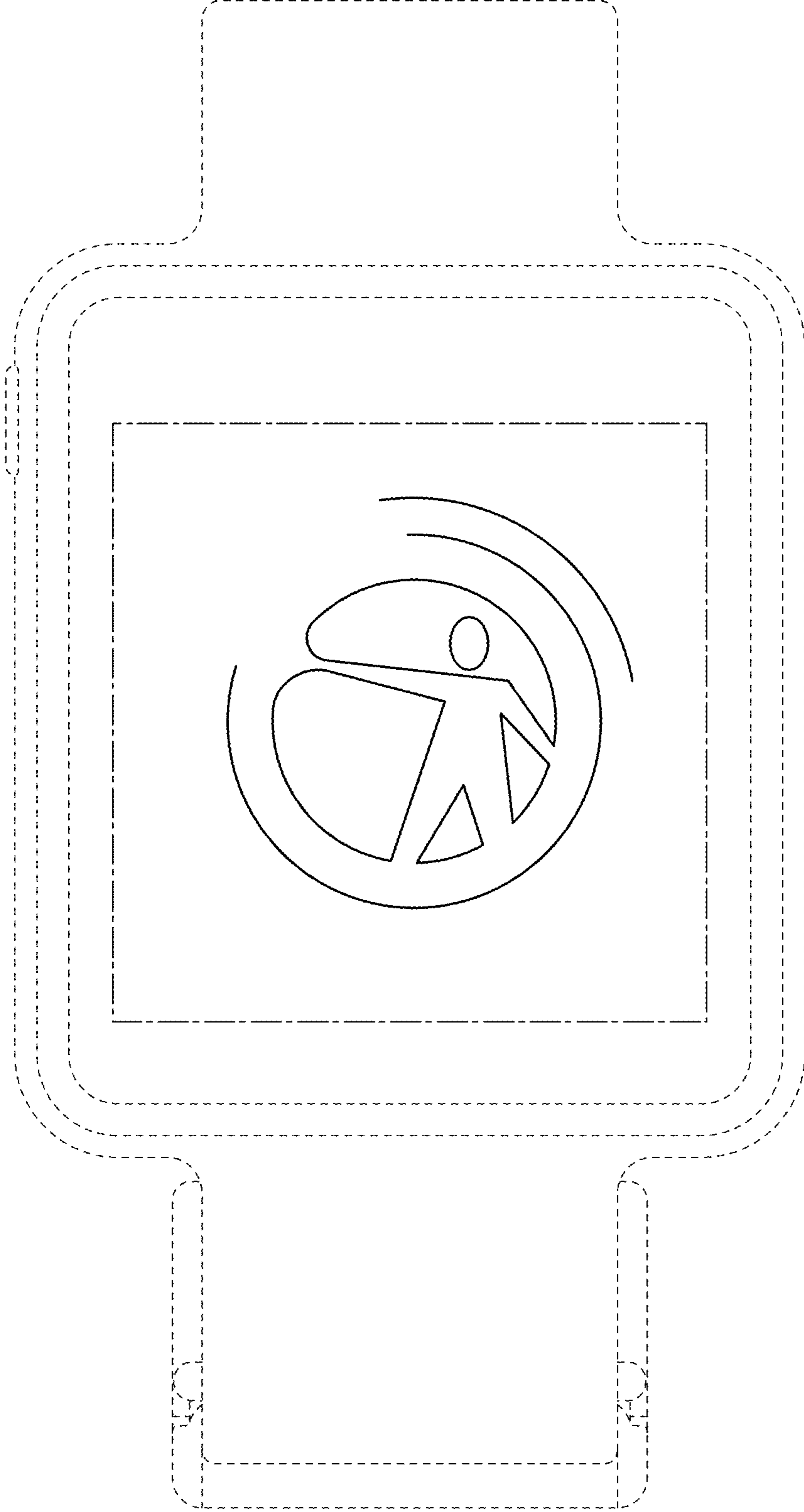

FIG. 6



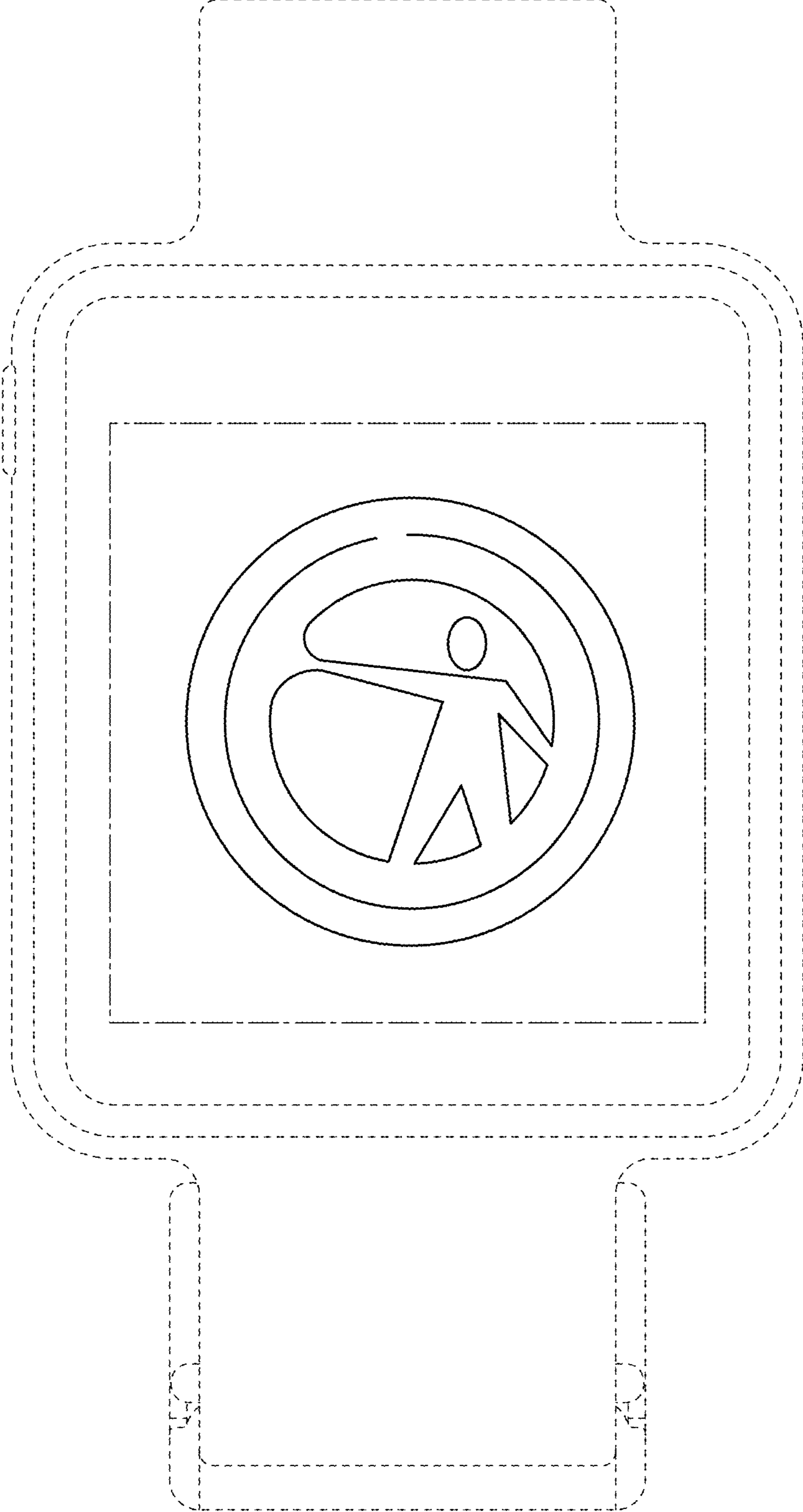

FIG. 7

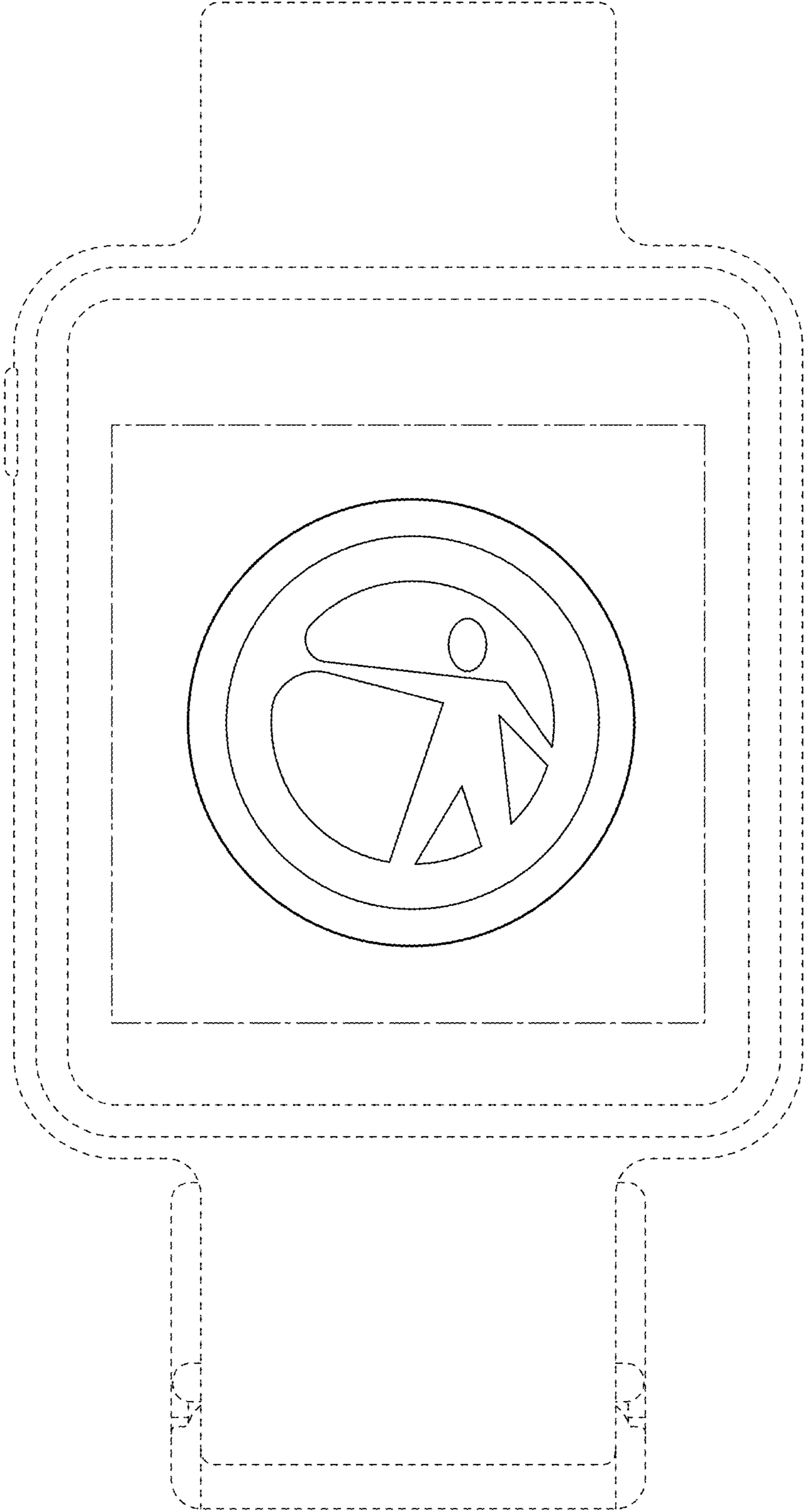

FIG. 8

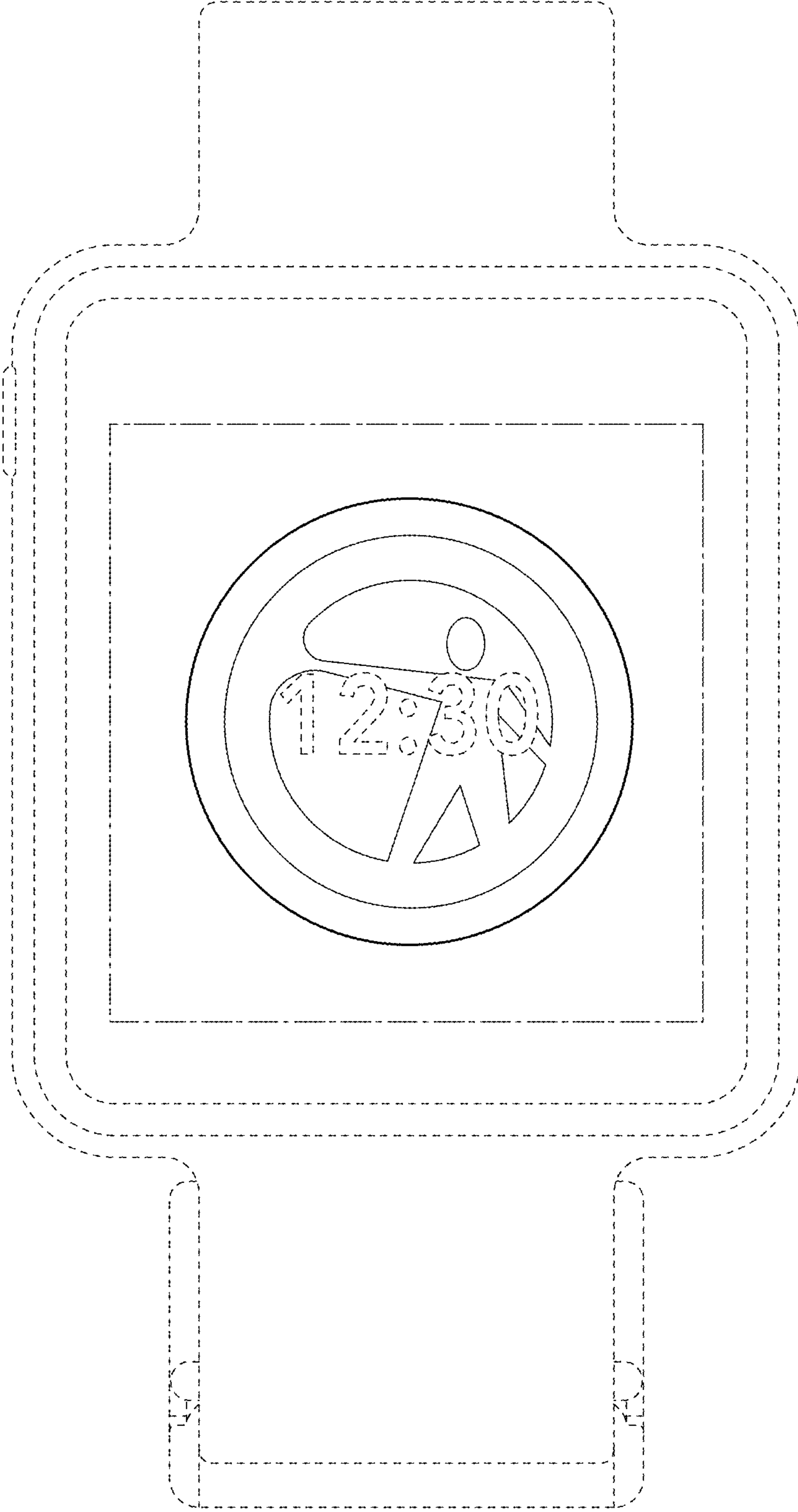

FIG. 9