



US00D770451S

(12) **United States Design Patent** (10) **Patent No.:** **US D770,451 S**
Gilbertson et al. (45) **Date of Patent:** **** Nov. 1, 2016**

(54) **ELECTRONIC KEY CONTROL UNIT**

(71) Applicant: **3-EAST, LLC**, Coatesville, PA (US)

(72) Inventors: **Matthew Gilbertson**, Downingtown, PA (US); **Jeffrey Gilbertson**, Honey Brook, PA (US); **Timothy Freese**, Coatesville, PA (US)

(73) Assignee: **3-EAST, LLC**, Coatesville, PA (US)

(**) Term: **15 Years**

(21) Appl. No.: **29/545,295**

(22) Filed: **Nov. 11, 2015**

(51) **LOC (10) Cl.** **14-02**

(52) **U.S. Cl.**
USPC **D14/383**

(58) **Field of Classification Search**
USPC D14/356-358, 383-385, 420, 426, 427, D14/432-439, 447, 453, 454, 217, 253, 299, D14/307; D13/107, 108, 133, 146, 147, D13/152, 154, 156, 158, 162, 162.1, 168, D13/173, 177, 102; 235/441, 451, 492, 380, 235/439, 375; 361/679.31, 600, 679.01, 361/679.02
CPC G07C 9/00103; G07C 9/00039; G07C 9/00904; G06K 5/00; G06K 7/01
See application file for complete search history.

(56) **References Cited**

U.S. PATENT DOCUMENTS

D480,725 S * 10/2003 Funato D14/383
D616,439 S * 5/2010 Mugica D14/383

D668,251 S * 10/2012 Morrell D14/383
D673,952 S * 1/2013 Toda D14/383
D712,407 S * 9/2014 Chang D14/389
D716,815 S * 11/2014 van Hees D14/420
D718,282 S * 11/2014 Bennett D13/163
D720,393 S * 12/2014 Held D18/4.4
D727,901 S * 4/2015 Nishimura D14/383
D741,298 S * 10/2015 Lintz D14/217
2008/0170049 A1 * 7/2008 Larson G06F 3/03545
345/179

* cited by examiner

Primary Examiner — Austin Murphy

(74) *Attorney, Agent, or Firm* — Frank J. Bonini, Jr.; John F. A. Earley, III; Harding, Earley, Follmer & Frailey, P.C.

(57) **CLAIM**

The ornamental design for an electronic key control unit, as shown and described.

DESCRIPTION

FIG. 1 is a perspective view of an electronic key control unit according to our new design, as viewed from the front, above and to the left of the device;
FIG. 2 is a front elevation view thereof;
FIG. 3 is a rear elevation view thereof;
FIG. 4 is a right side elevation view thereof;
FIG. 5 is a left side elevation view thereof;
FIG. 6 is a top plan view thereof; and,
FIG. 7 is a bottom plan view thereof.
The broken lines in FIGS. 1-7 are for illustrative purposes and form no part of the claimed invention.

1 Claim, 7 Drawing Sheets

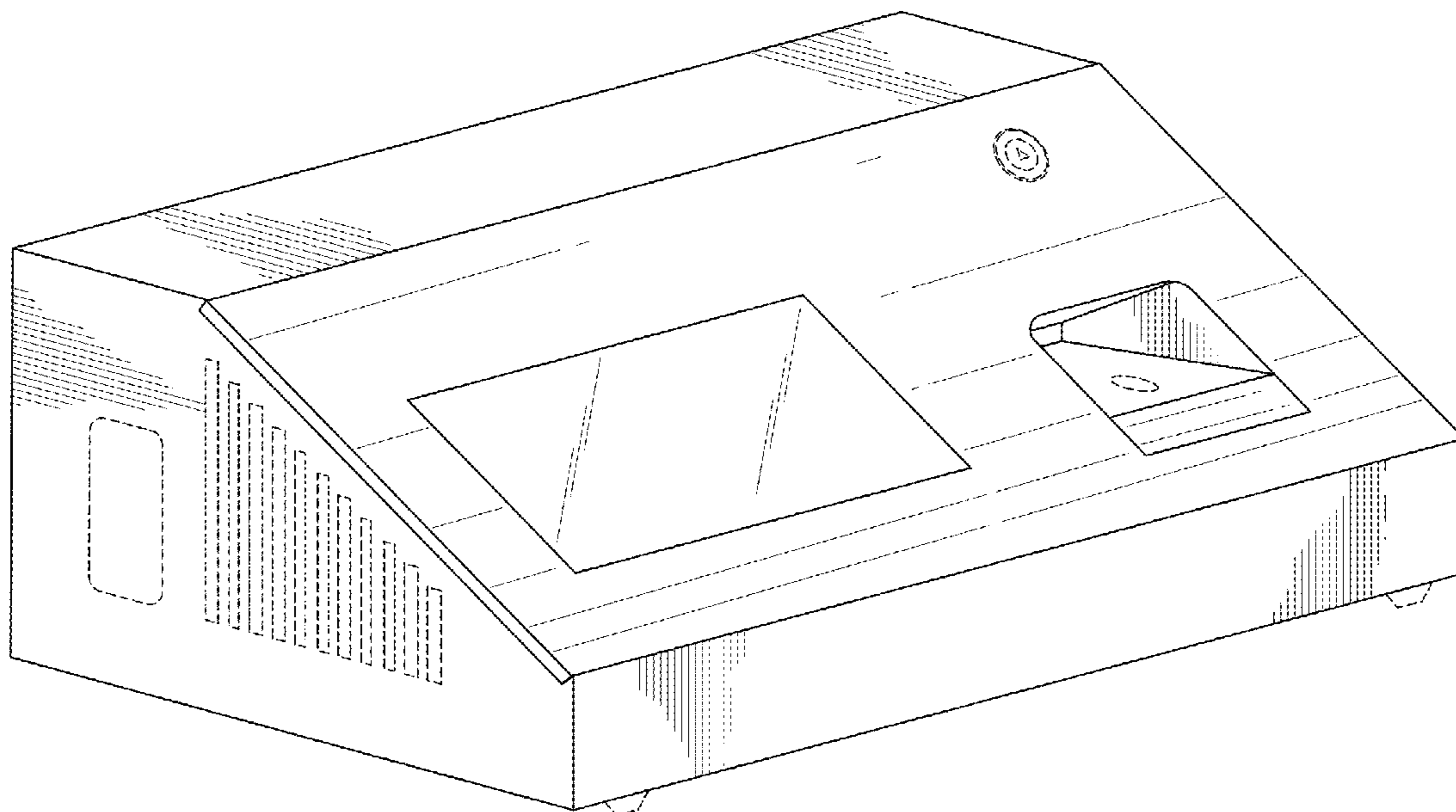

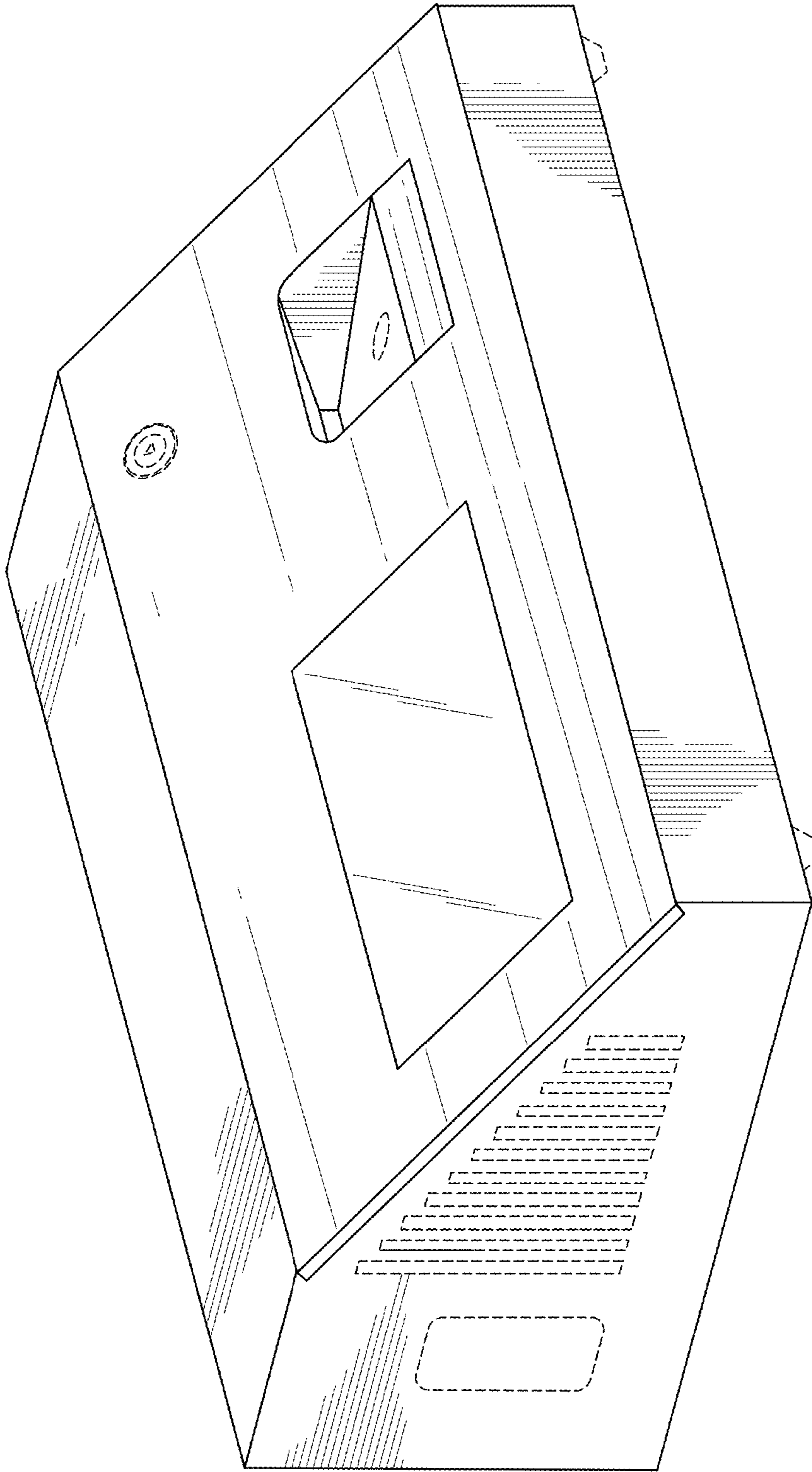

FIG.1

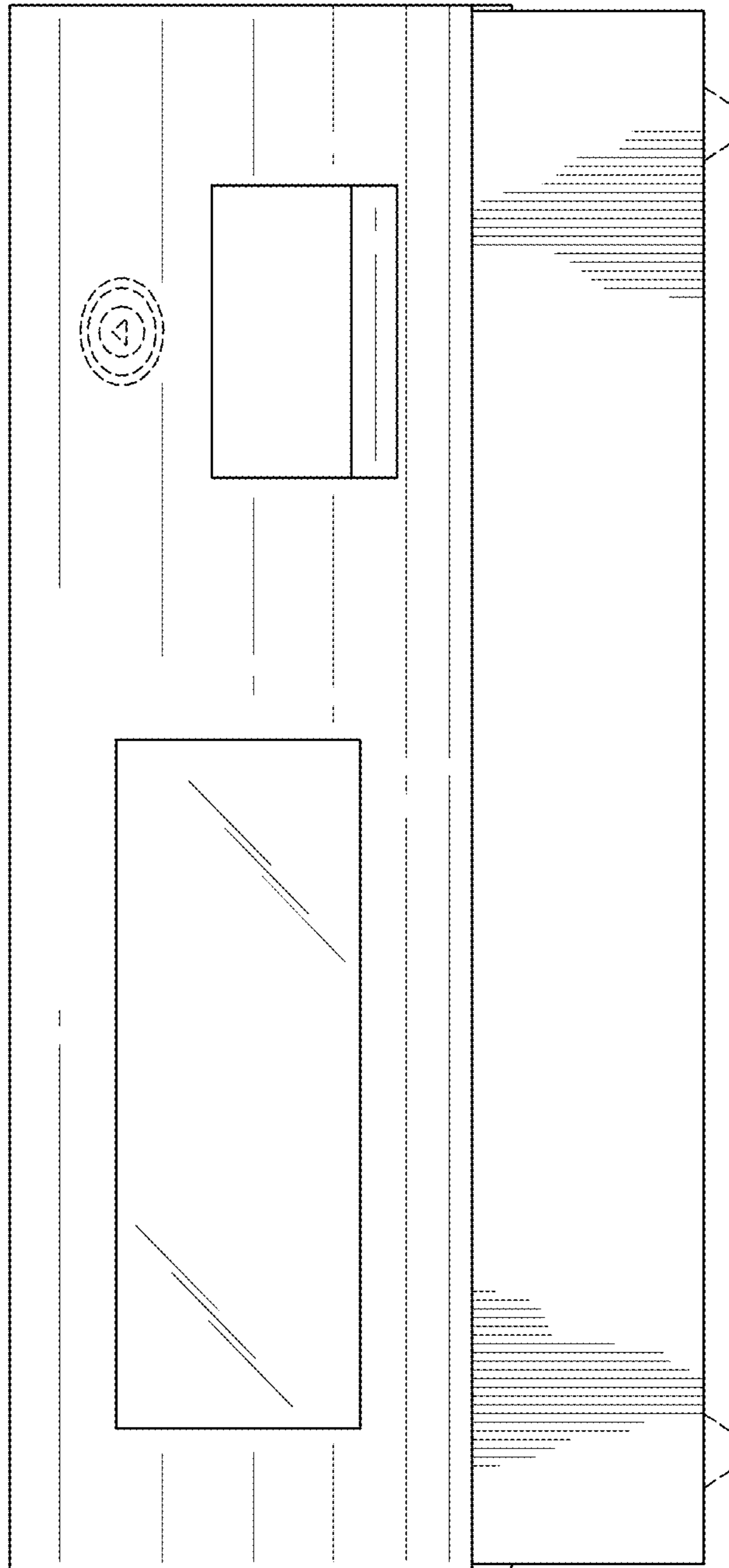

FIG. 2

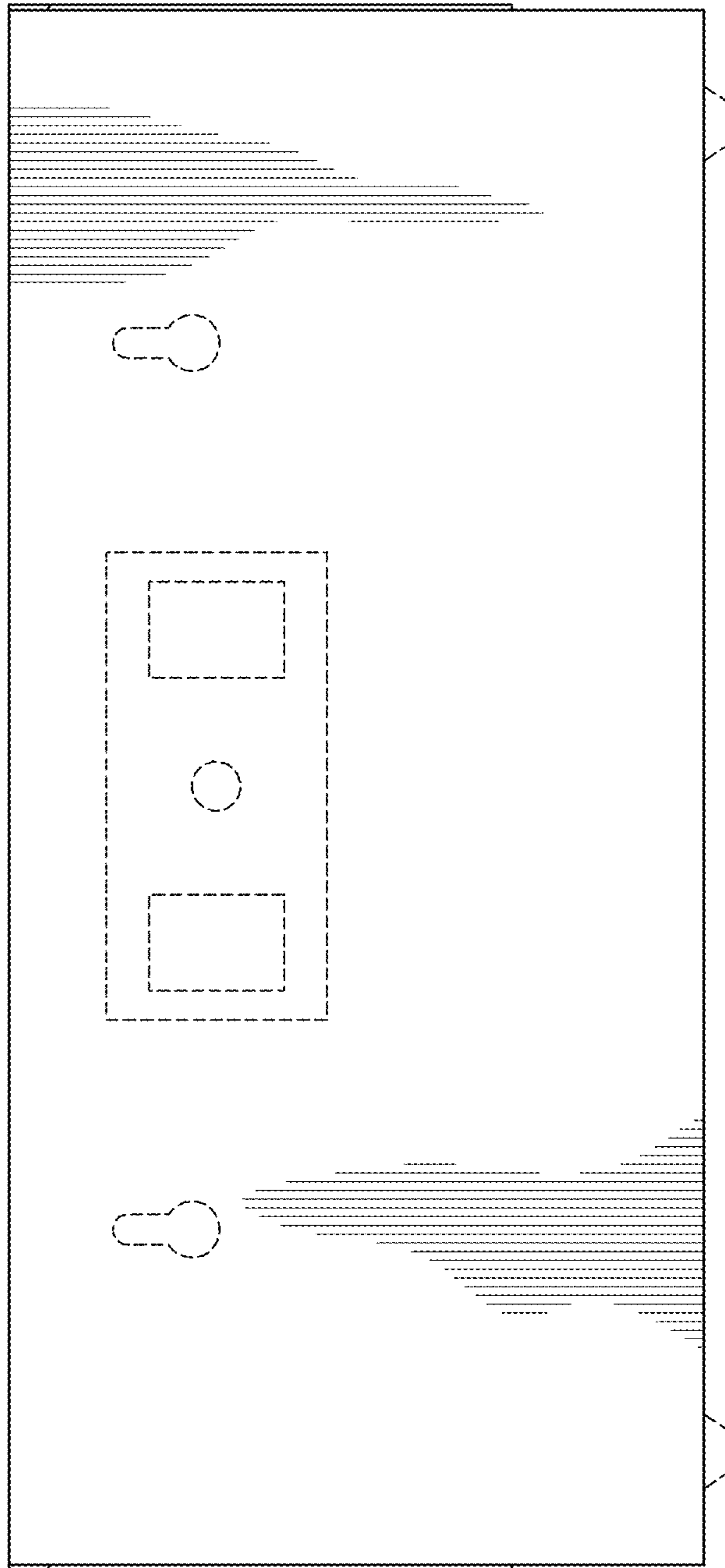

FIG. 3

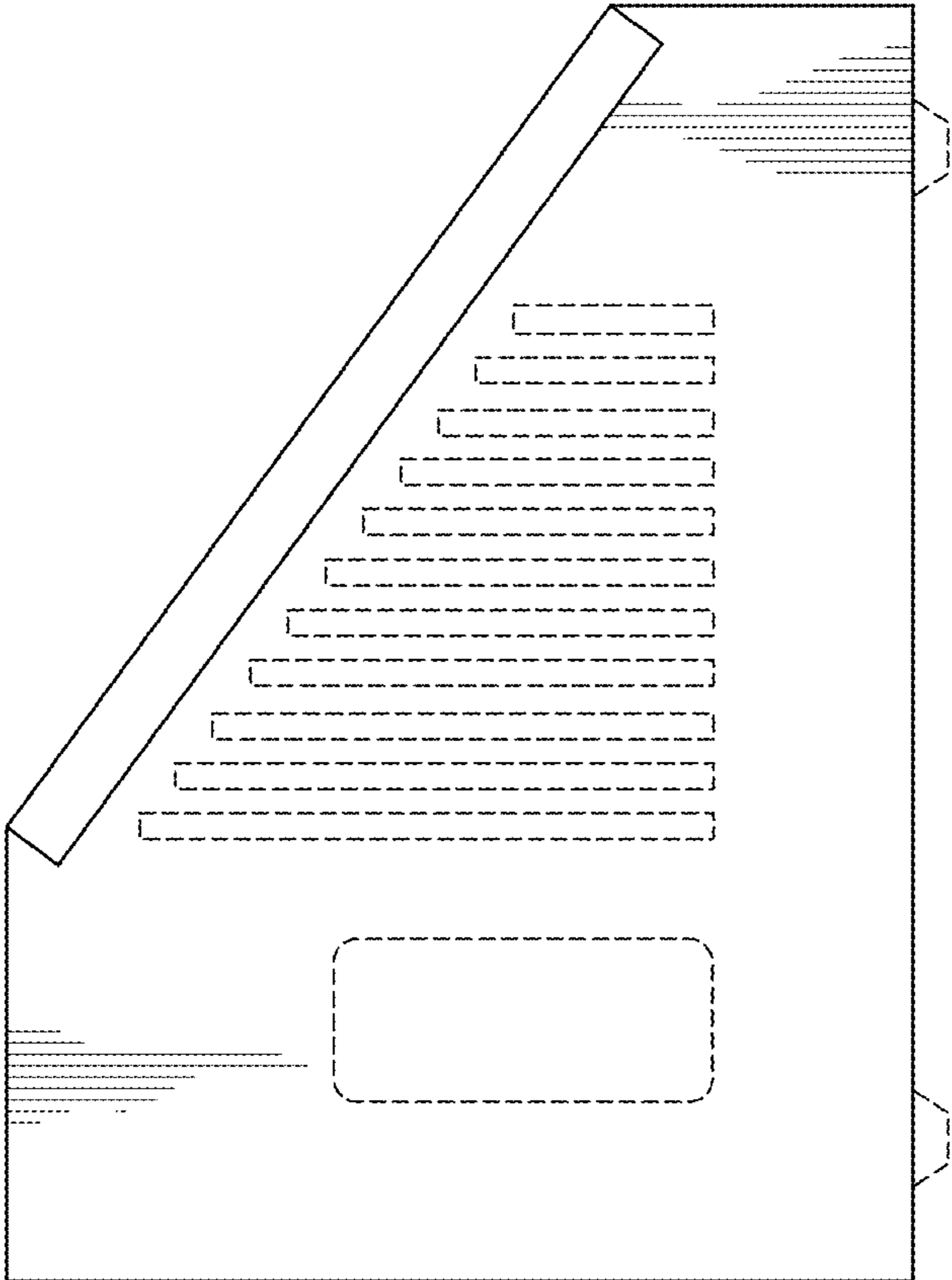

FIG. 4

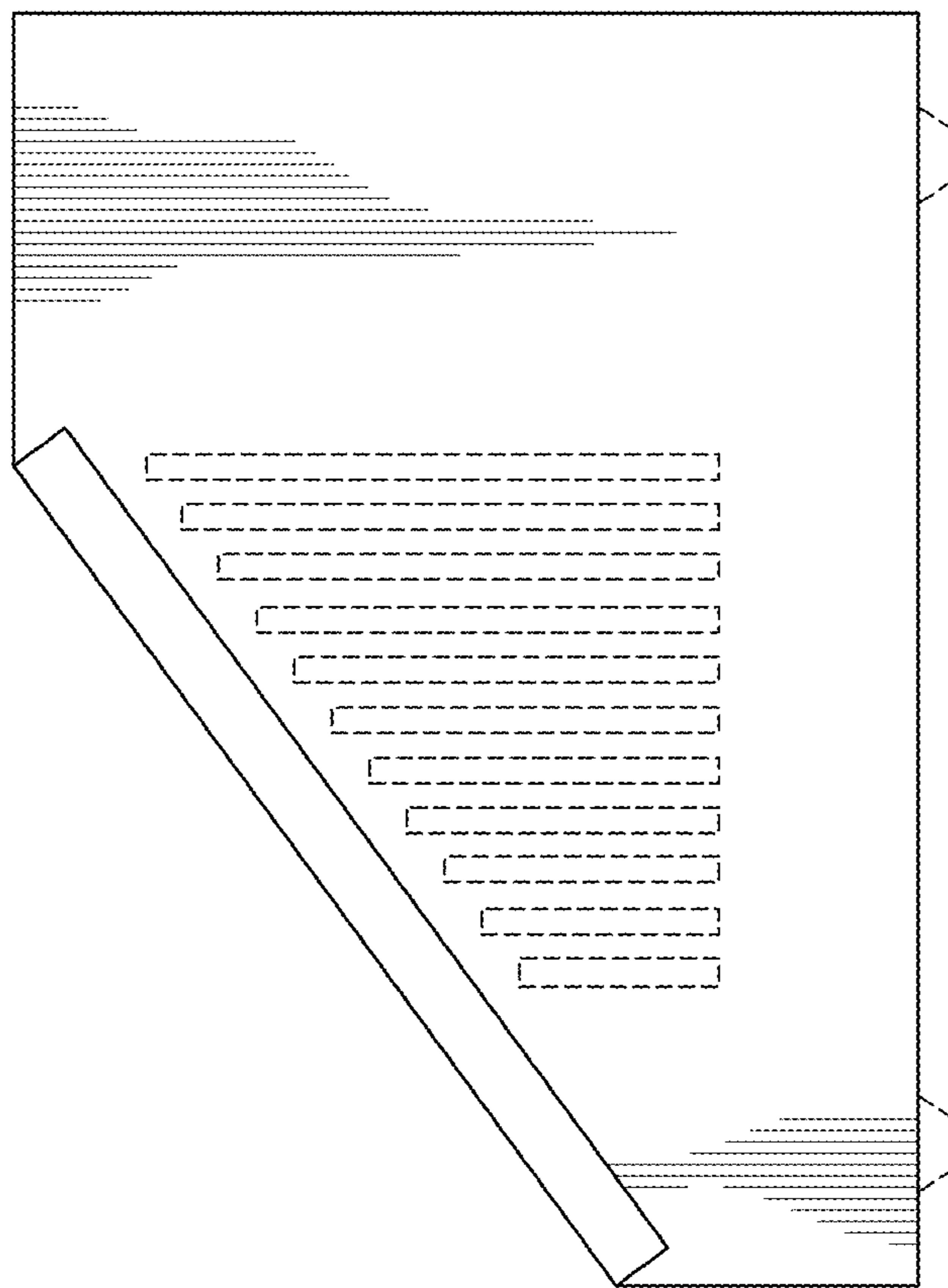

FIG. 5

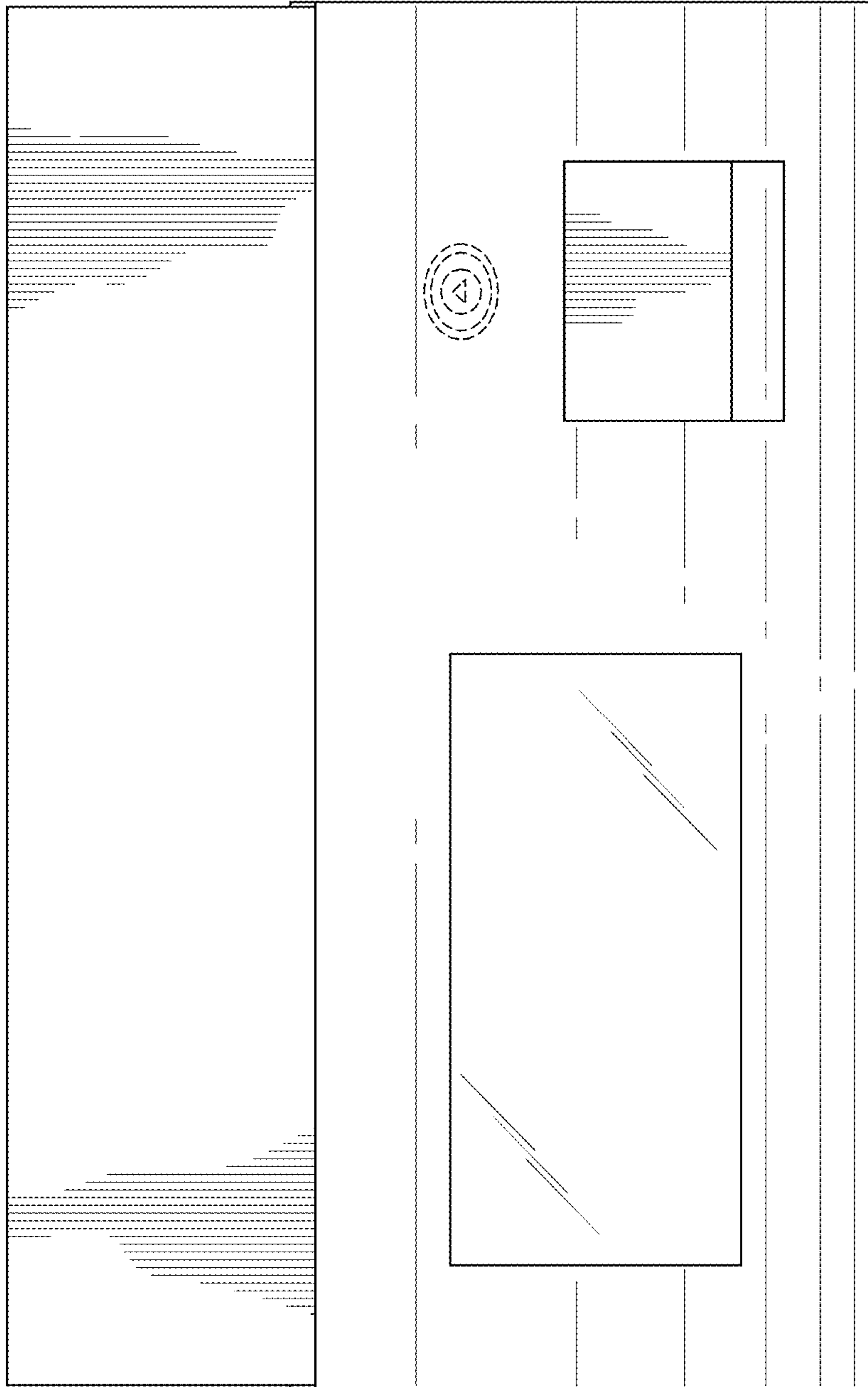

FIG. 6



FIG. 7