



US00D770440S

(12) **United States Design Patent**
Chou

(10) **Patent No.:** **US D770,440 S**

(45) **Date of Patent:** **** Nov. 1, 2016**

(54) **NOTEBOOK COMPUTER**

(74) *Attorney, Agent, or Firm* — Jianq Chyun IP Office

(71) Applicant: **Acer Incorporated**, New Taipei (TW)

(72) Inventor: **Li-Hsuan Chou**, New Taipei (TW)

(73) Assignee: **Acer Incorporated**, New Taipei (TW)

(**) Term: **14 Years**

(21) Appl. No.: **29/509,304**

(22) Filed: **Nov. 17, 2014**

(30) **Foreign Application Priority Data**

Aug. 29, 2014 (TW) 103305104

(51) **LOC (10) Cl.** **14-02**

(52) **U.S. Cl.**
USPC **D14/315**

(58) **Field of Classification Search**

USPC D14/315-327; D18/1, 2, 7, 11;
235/145 A, 145 R; 341/22, 23; 345/104,
345/156, 168, 169, 173; 361/679.08,
361/679.09, 679.11, 679.26, 679.27

CPC G06F 1/16; G06F 1/1616; G06F 1/1626;
G06F 1/1632; G06F 1/1613; G06F 1/1601;
G06F 1/1618; G06F 1/162; H01R 35/02;
H03M 11/00; G09B 13/04; H03K 17/94;
G09G 5/00; F16M 11/10

See application file for complete search history.

(56) **References Cited**

U.S. PATENT DOCUMENTS

D407,386 S * 3/1999 Cronk D14/327
D430,155 S * 8/2000 Cronk D14/327
6,771,494 B2 * 8/2004 Shimano G06F 1/1616
345/173
D633,905 S * 3/2011 Ke D14/315
D714,284 S * 9/2014 Lin D14/315

* cited by examiner

Primary Examiner — Freda S Nunn

(57) **CLAIM**

The ornamental design for a notebook computer, as shown and described.

DESCRIPTION

FIG. 1 is a perspective view of a notebook computer showing my new design;

FIG. 2 is another perspective view thereof;

FIG. 3 is a front view thereof;

FIG. 4 is a rear view thereof;

FIG. 5 is a left side view thereof;

FIG. 6 is a right side view thereof;

FIG. 7 is a top view thereof;

FIG. 8 is a bottom view thereof;

FIG. 9 is a perspective view thereof, shown in an unfolded position of use;

FIG. 10 is another perspective view thereof, shown in an unfolded position of use;

FIG. 11 is a front view thereof, shown in an unfolded position of use;

FIG. 12 is a rear view thereof, shown in an unfolded position of use;

FIG. 13 is a left side view thereof, shown in an unfolded position of use;

FIG. 14 is a right side view thereof, shown in an unfolded position of use;

FIG. 15 is a top view thereof, shown in an unfolded position of use;

FIG. 16 is a bottom view thereof, shown in an unfolded position of use;

FIG. 17 is an enlarged view of an indicated portion of FIG. 3;

FIG. 18 is an enlarged view of an indicated portion of FIG. 4;

FIG. 19 is an enlarged view of an indicated portion of FIG. 4;

FIG. 20 is an enlarged view of an indicated portion of FIG. 4;

FIG. 21 is an enlarged view of an indicated portion of FIG. 4;

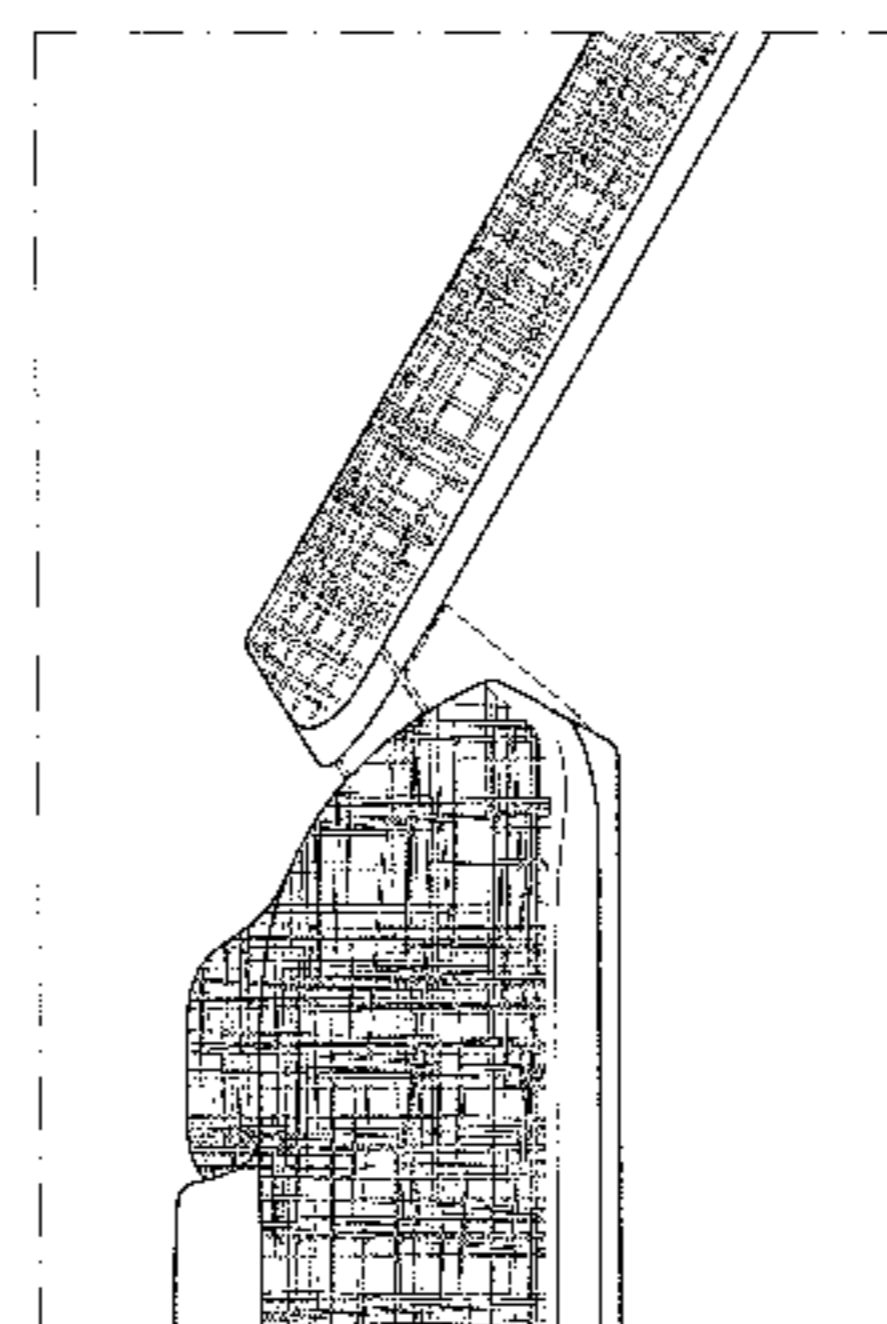
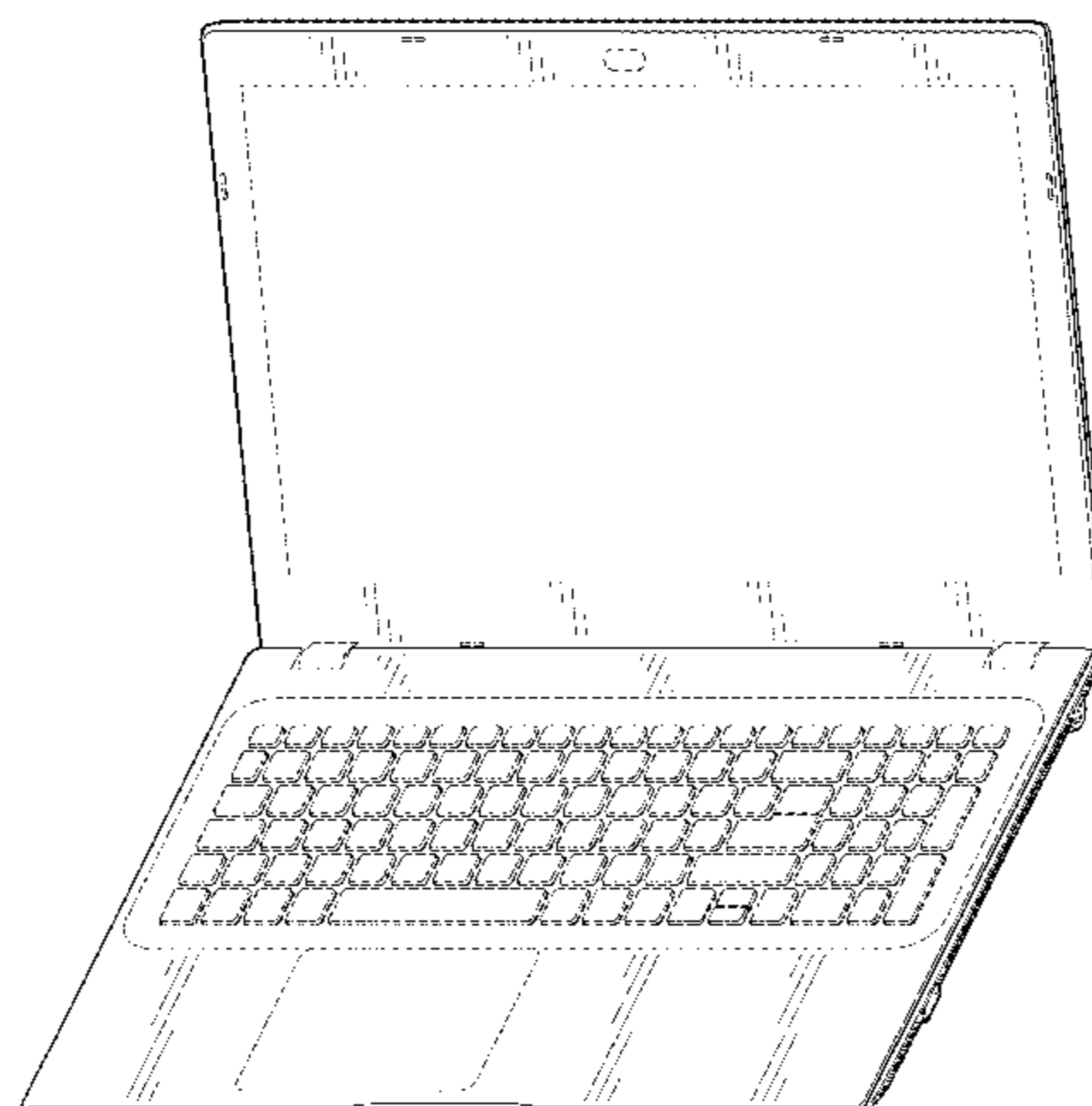

FIG. **22** is an enlarged view of an indicated portion of FIG. **5**;
FIG. **23** is an enlarged view of an indicated portion of FIG. **5**;
FIG. **24** is an enlarged view of an indicated portion of FIG. **7**;
FIG. **25** is an enlarged view of an indicated portion of FIG. **7**;
FIG. **26** is an enlarged view of an indicated portion of FIG. **8**;
FIG. **27** is an enlarged view of an indicated portion of FIG. **8**;
FIG. **28** is an enlarged view of an indicated portion of FIG. **12**;

FIG. **29** is an enlarged view of an indicated portion of FIG. **12**;
FIG. **30** is an enlarged view of an indicated portion of FIG. **13**;
FIG. **31** is an enlarged view of an indicated portion of FIG. **16**; and,
FIG. **32** is an enlarged view of an indicated portion of FIG. **16**.

The broken lines showing in the views are for the purpose of illustrating environmental structure and form no part of the claimed design. The intercross solid lines of the back cover and the bottom cover of the notebook computer shown in the views are textures.

1 Claim, 21 Drawing Sheets

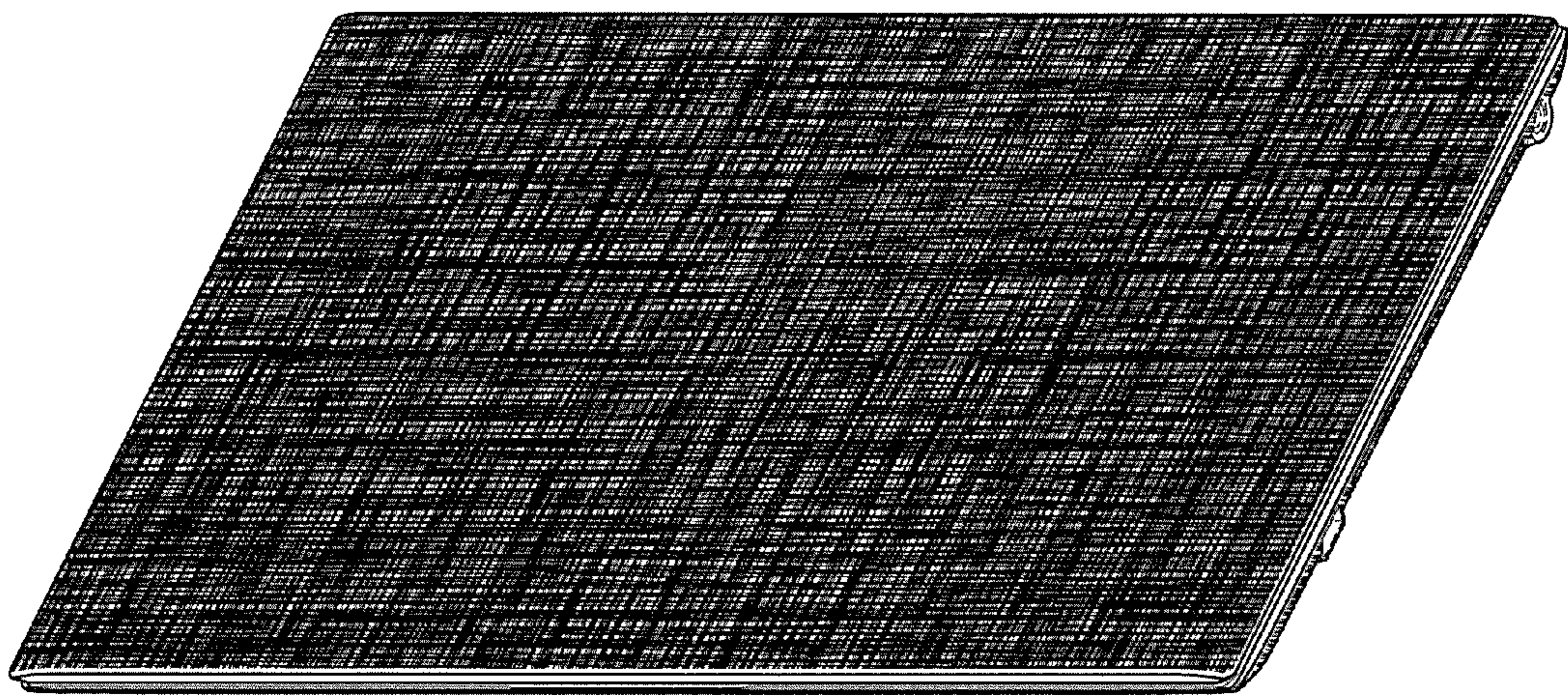

FIG. 1

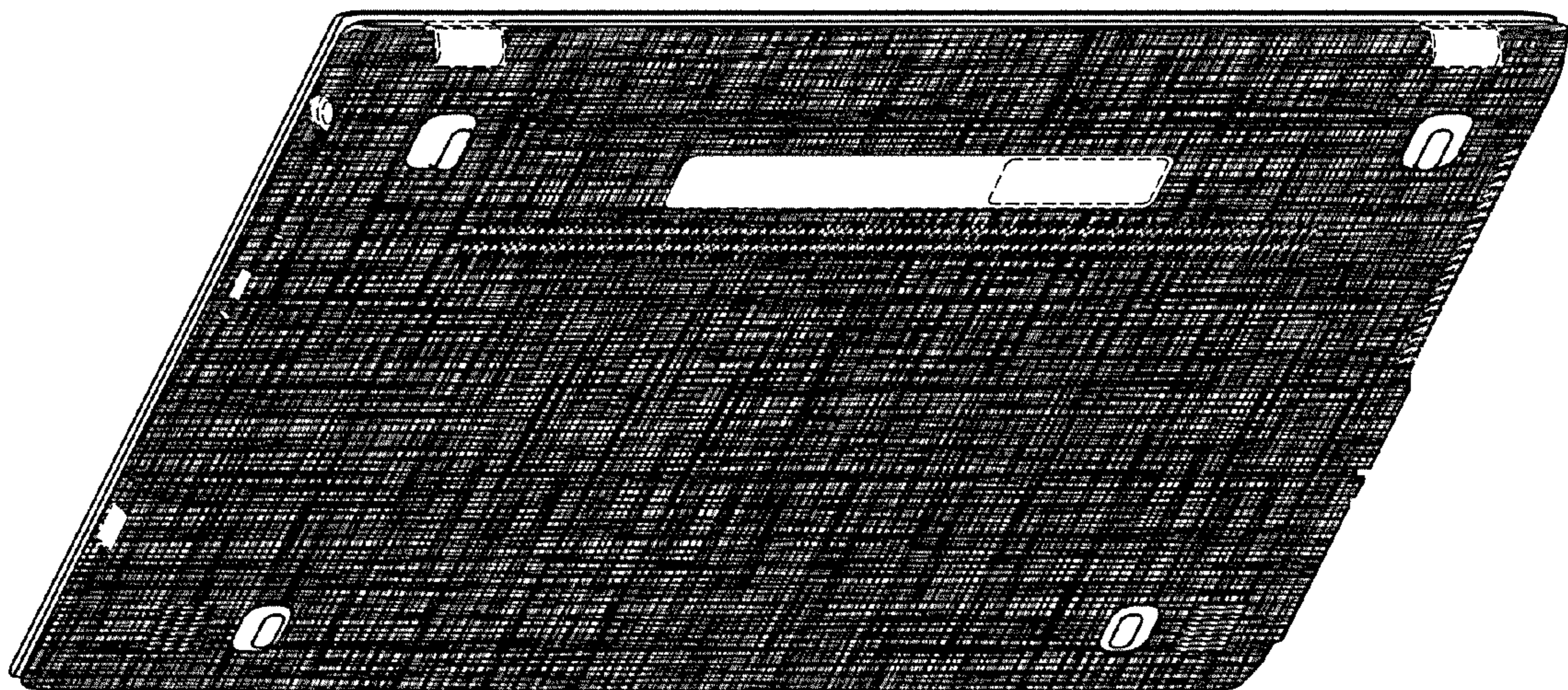

FIG. 2

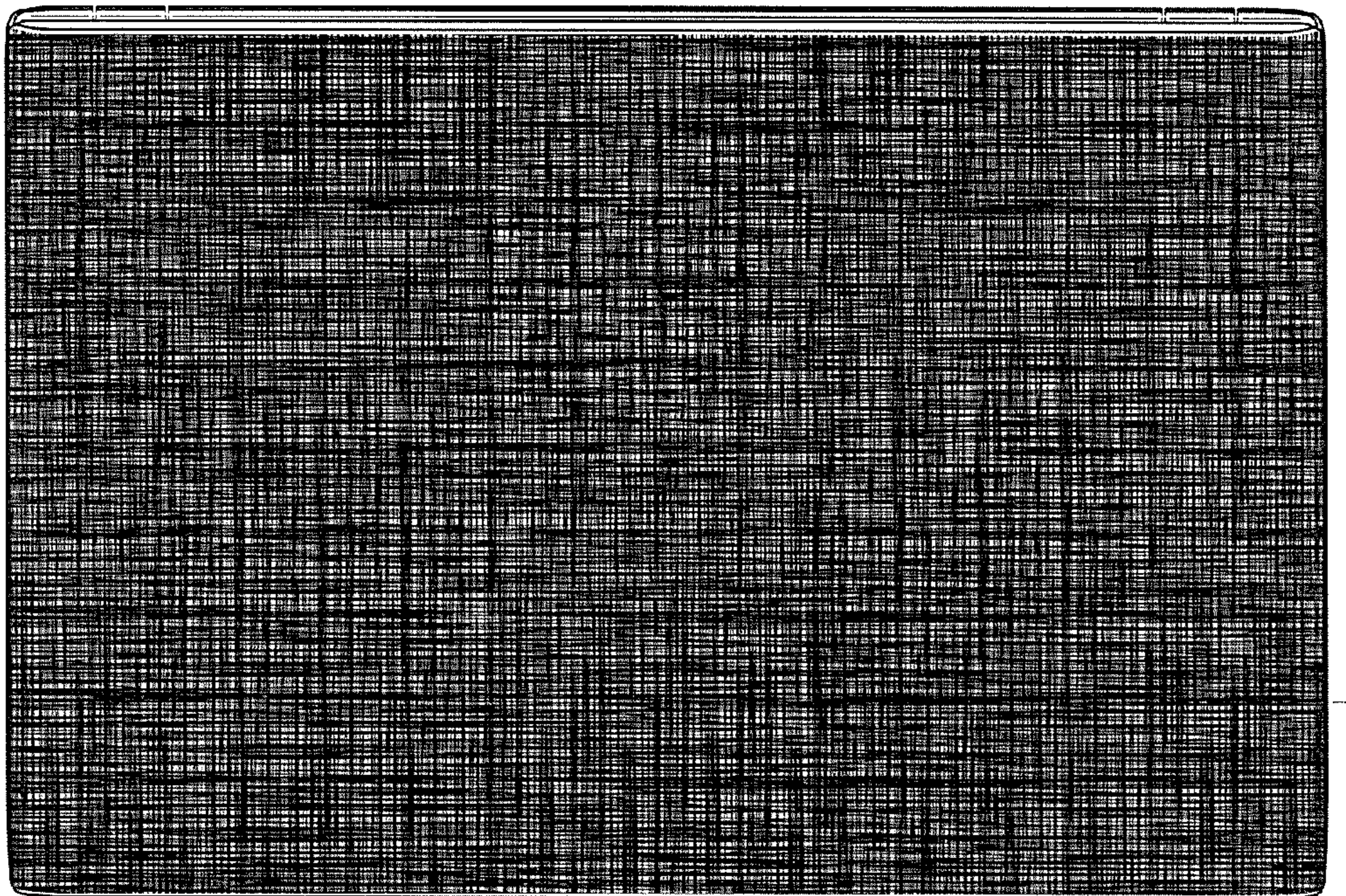

FIG.17

FIG. 3

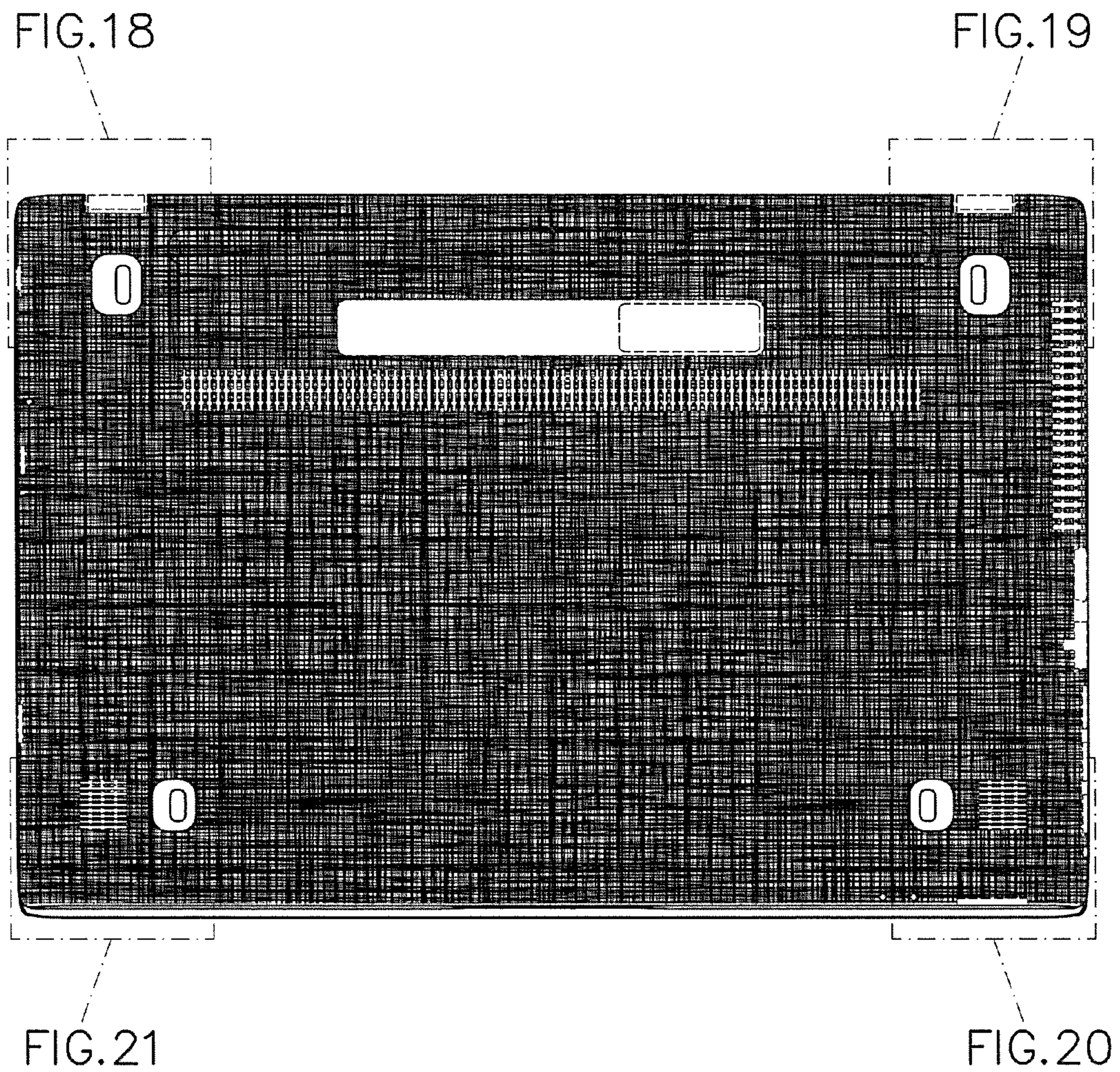

FIG. 4

FIG. 22

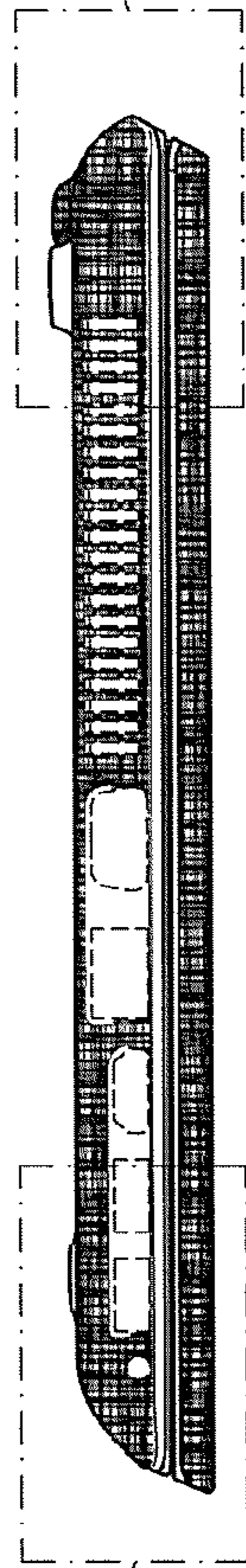

FIG. 23

FIG. 5

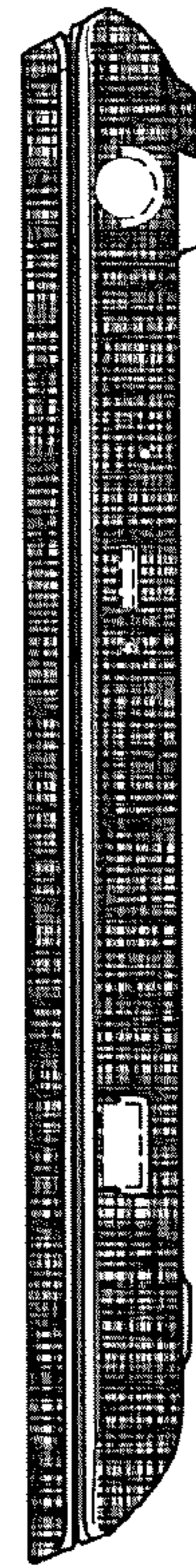

FIG. 6

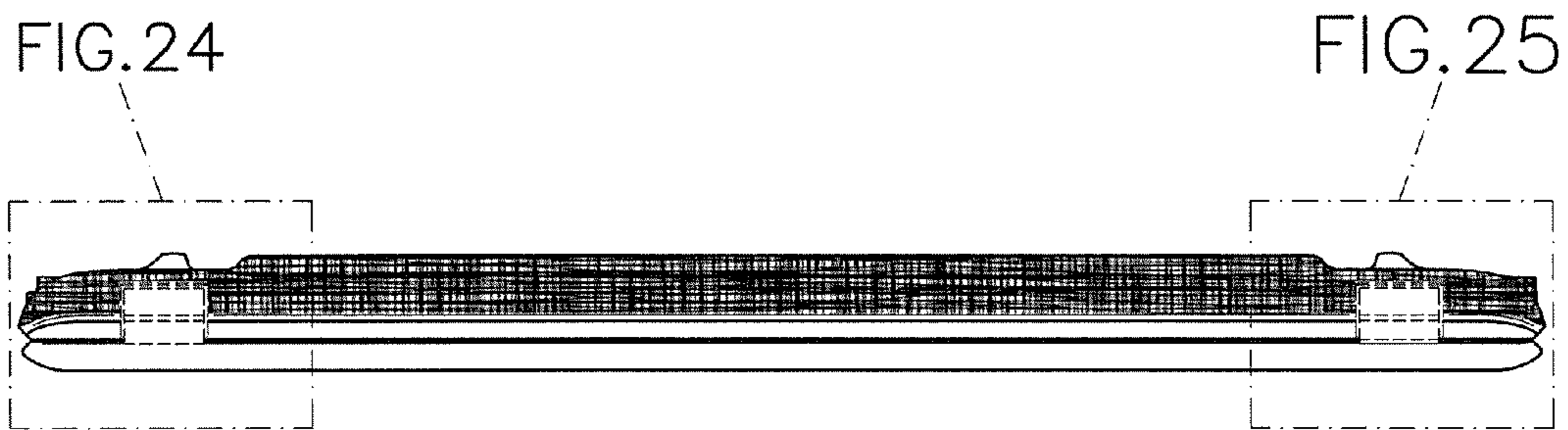

FIG. 7

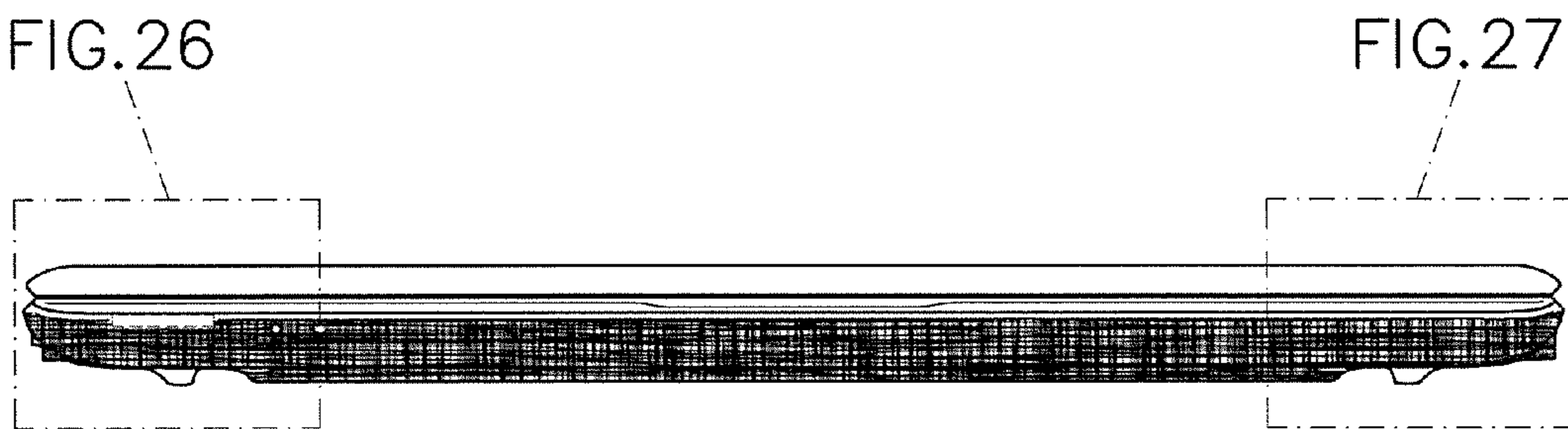

FIG. 8

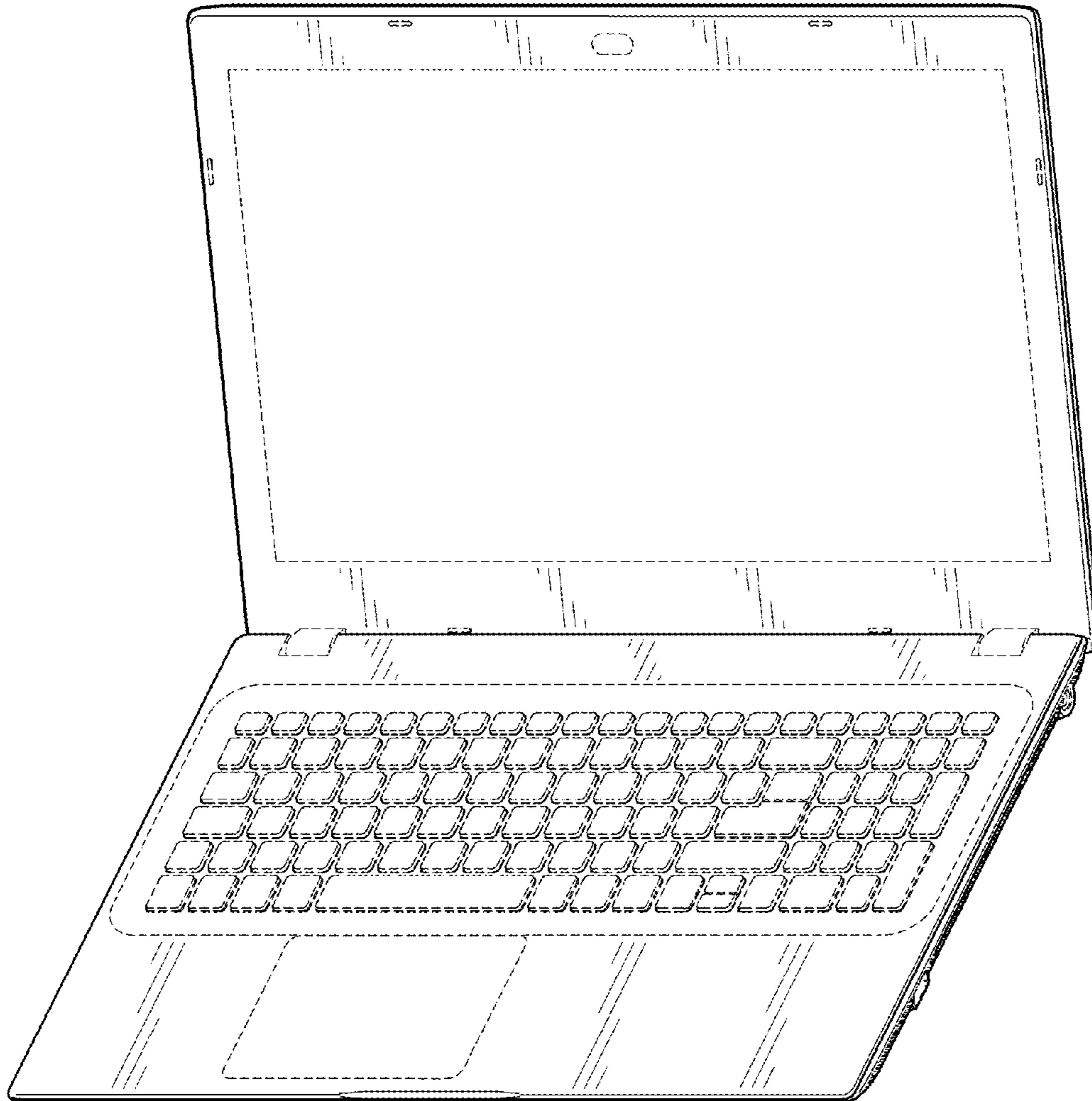

FIG. 9

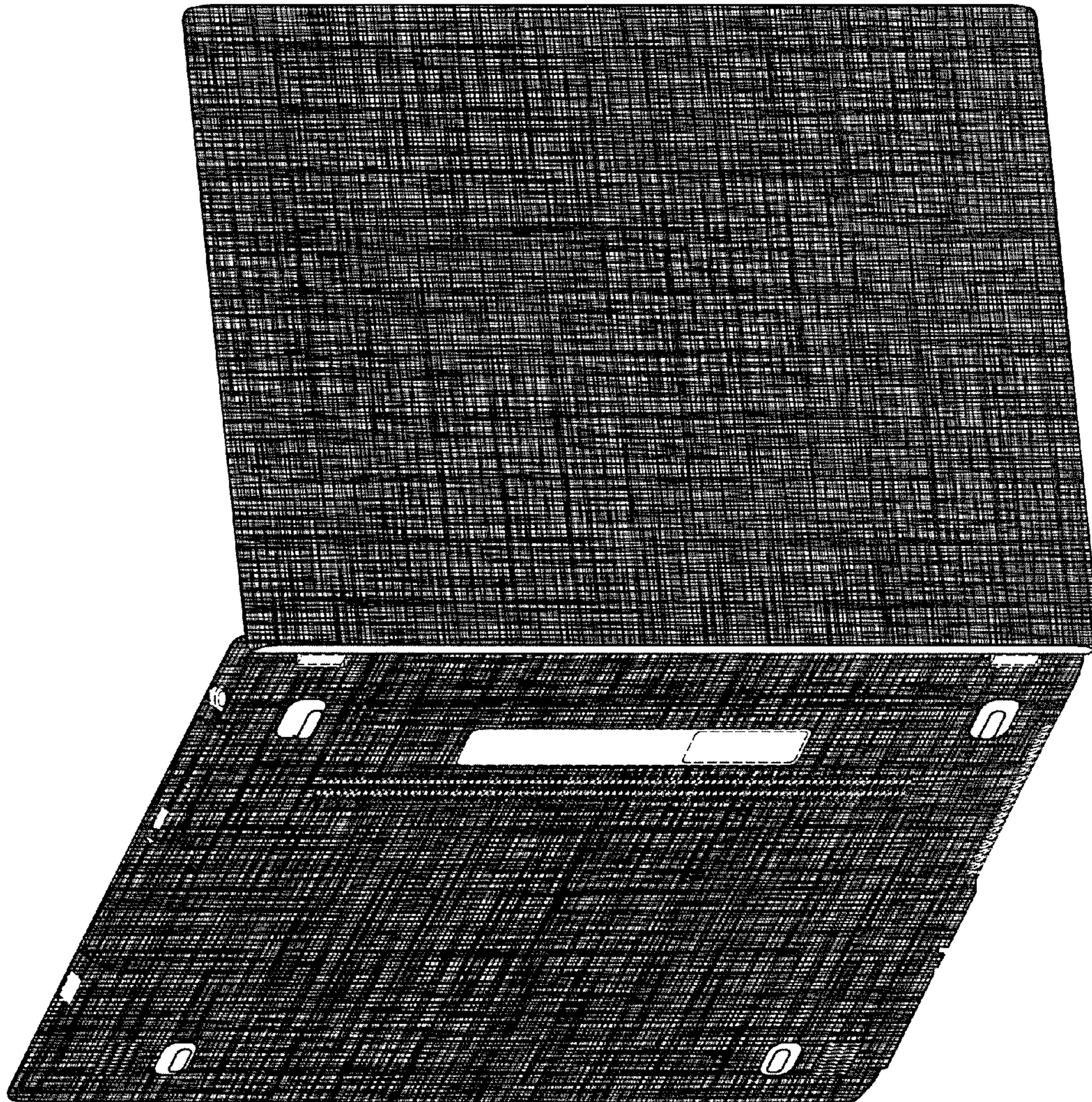

FIG. 10

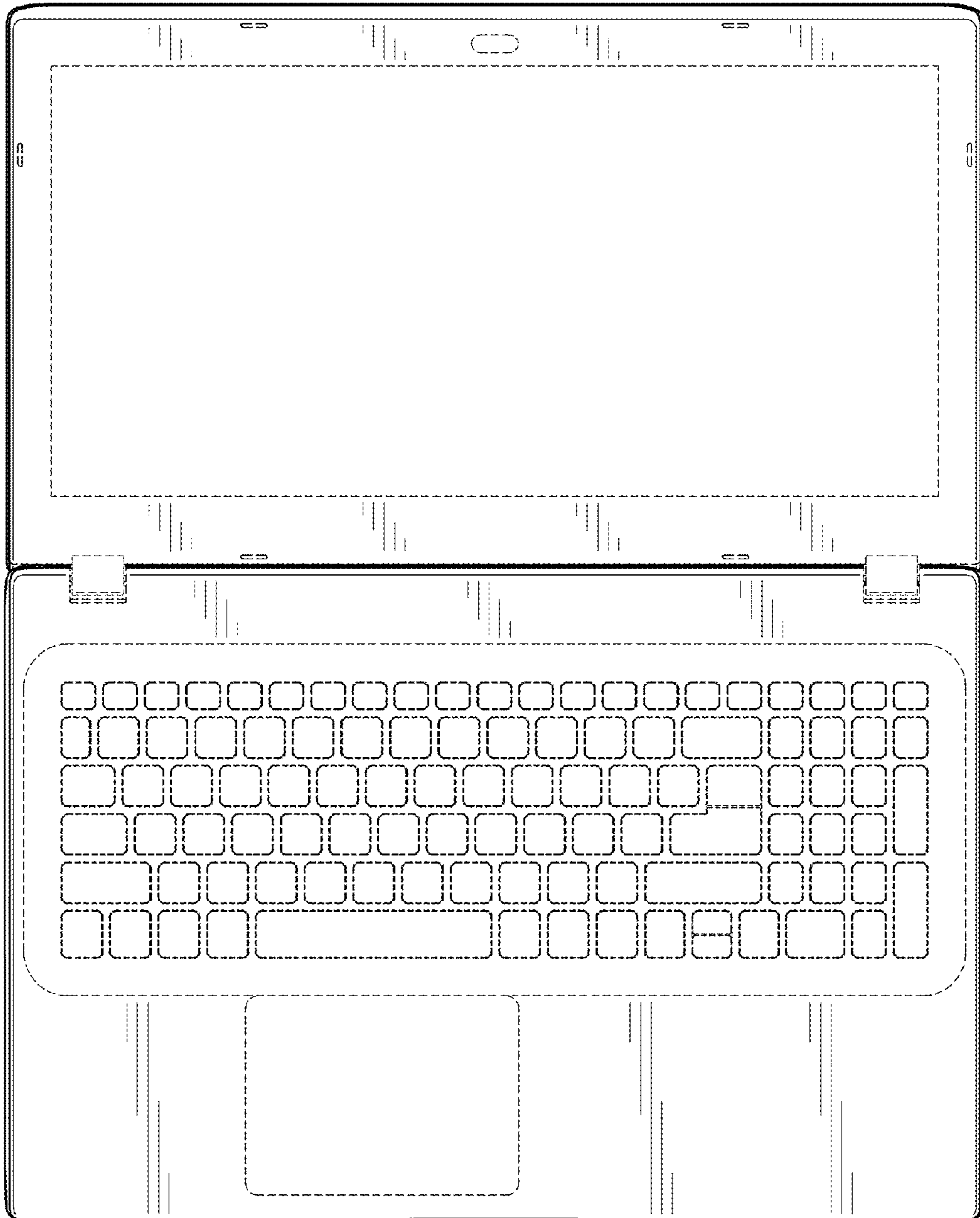

FIG. 11

FIG. 28

FIG. 29

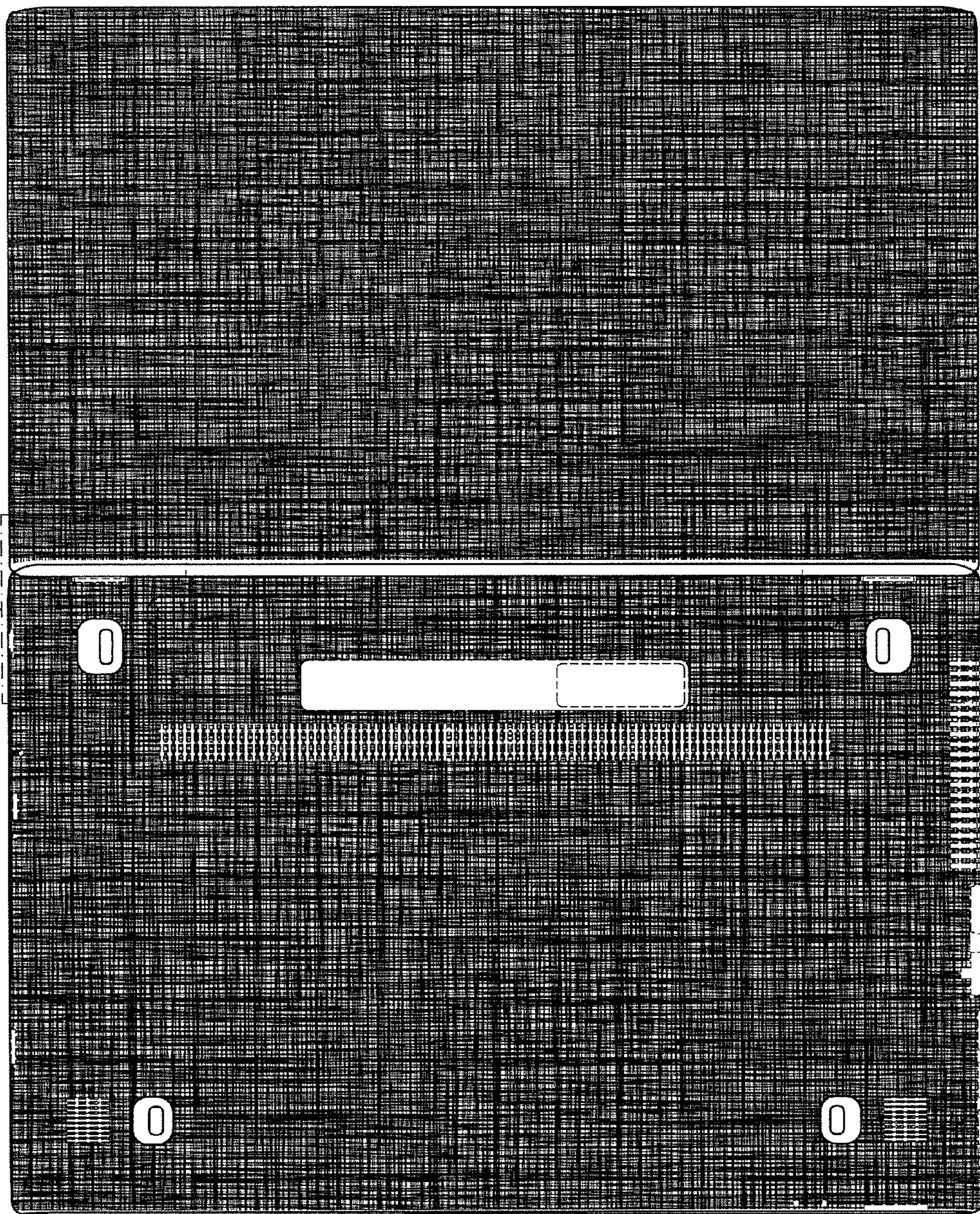

FIG. 12

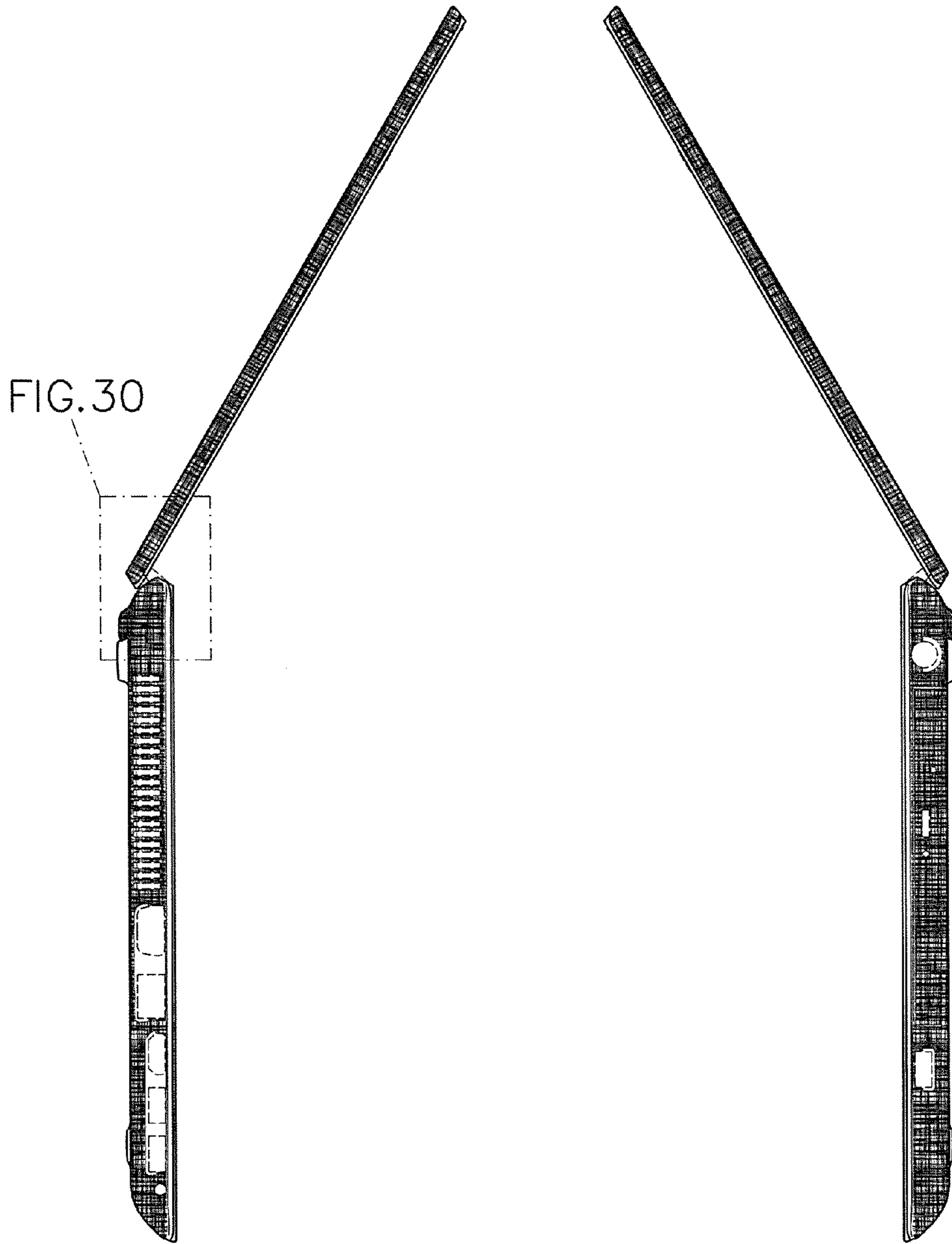

FIG. 13

FIG. 14

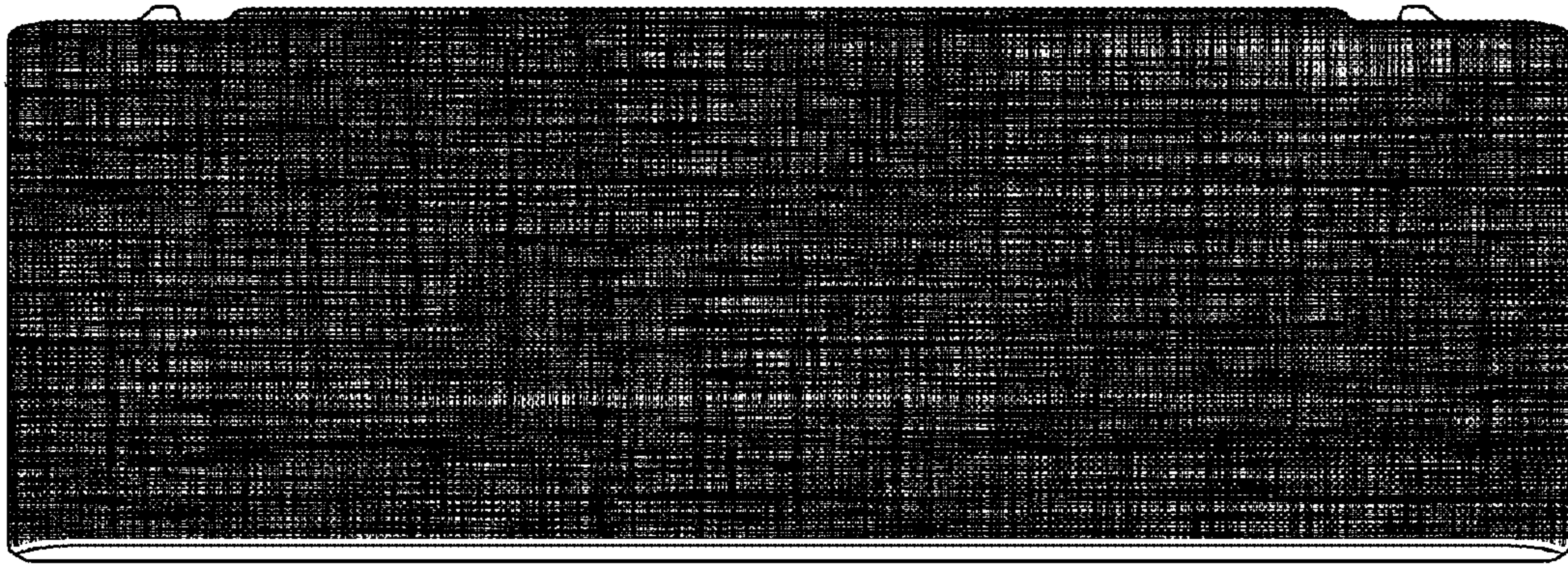

FIG. 15

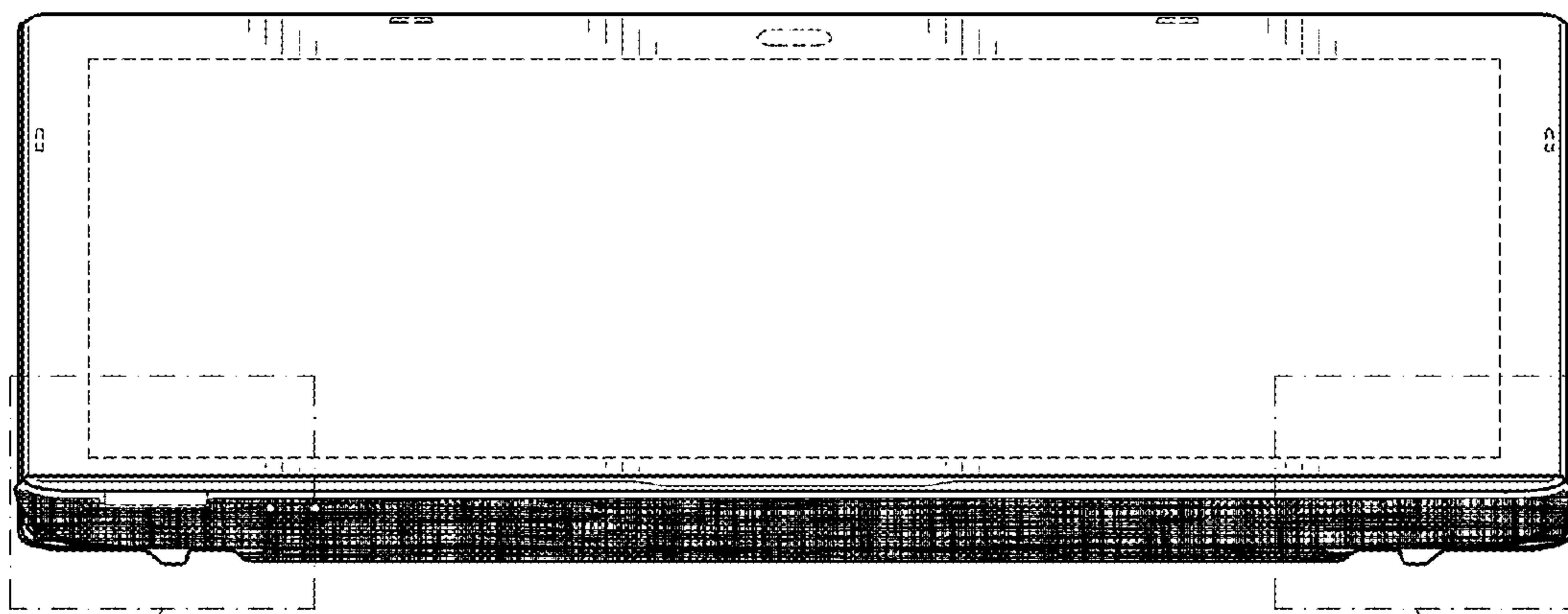

FIG. 31

FIG. 32

FIG. 16

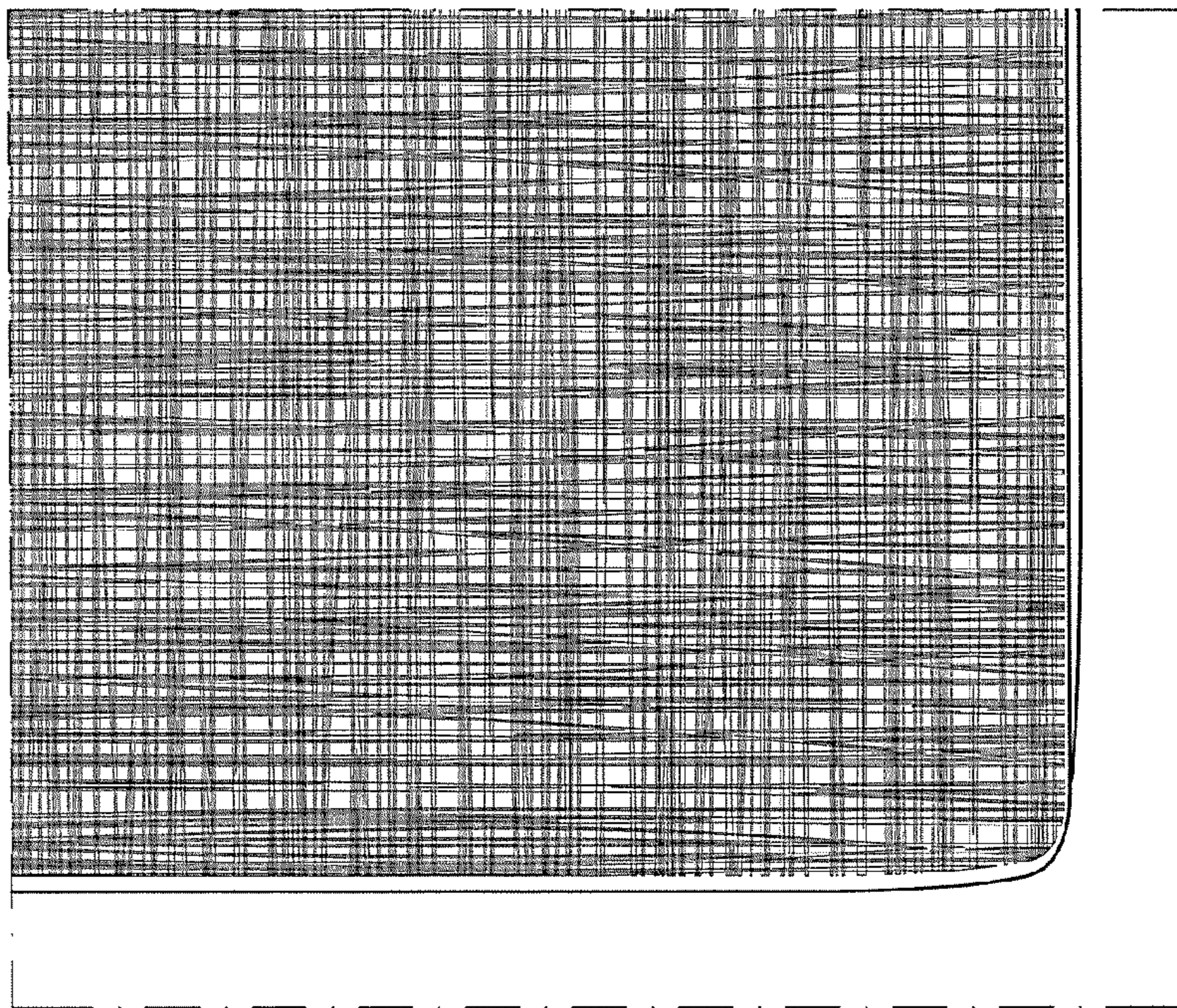

FIG. 17

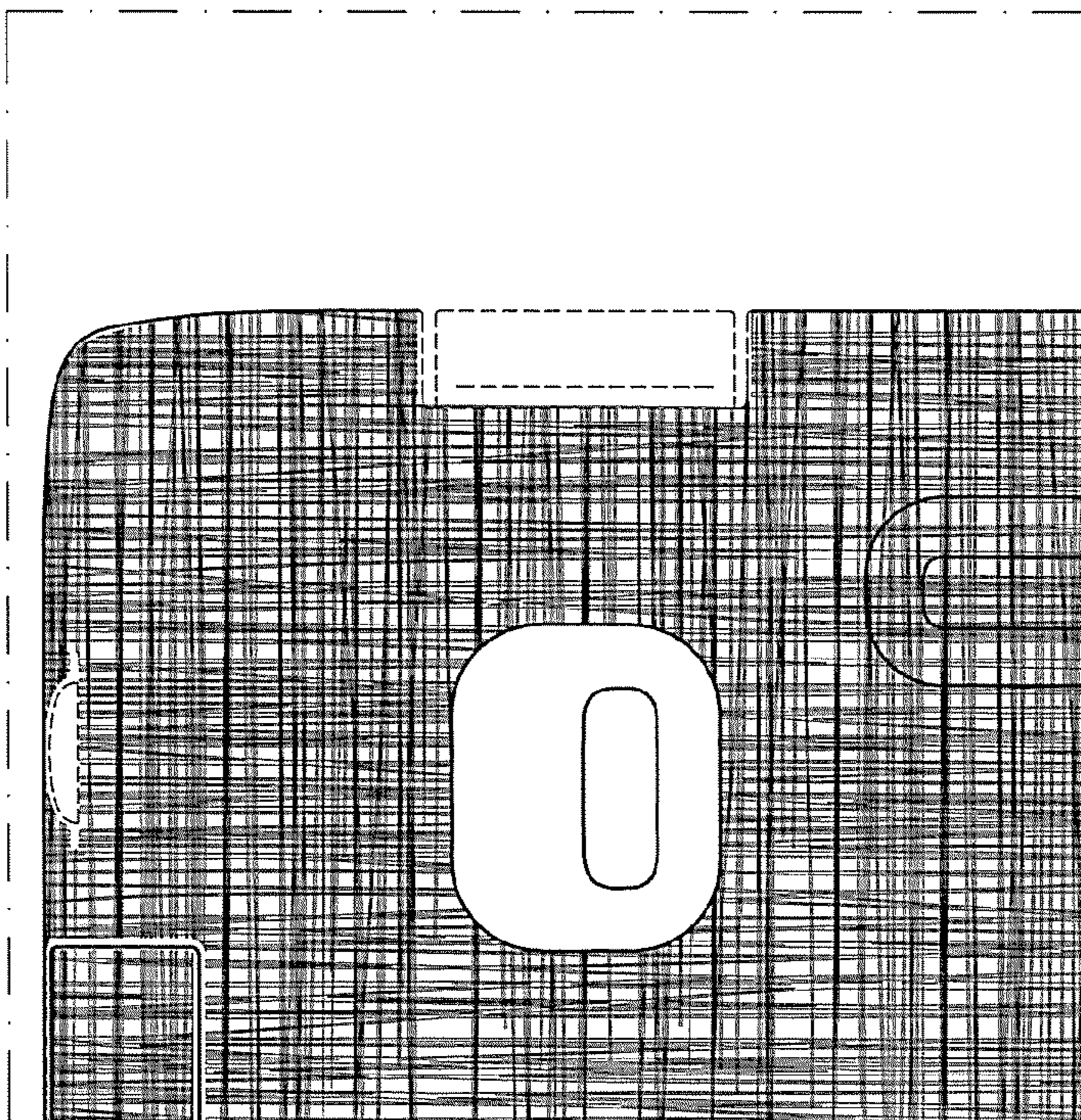

FIG. 18

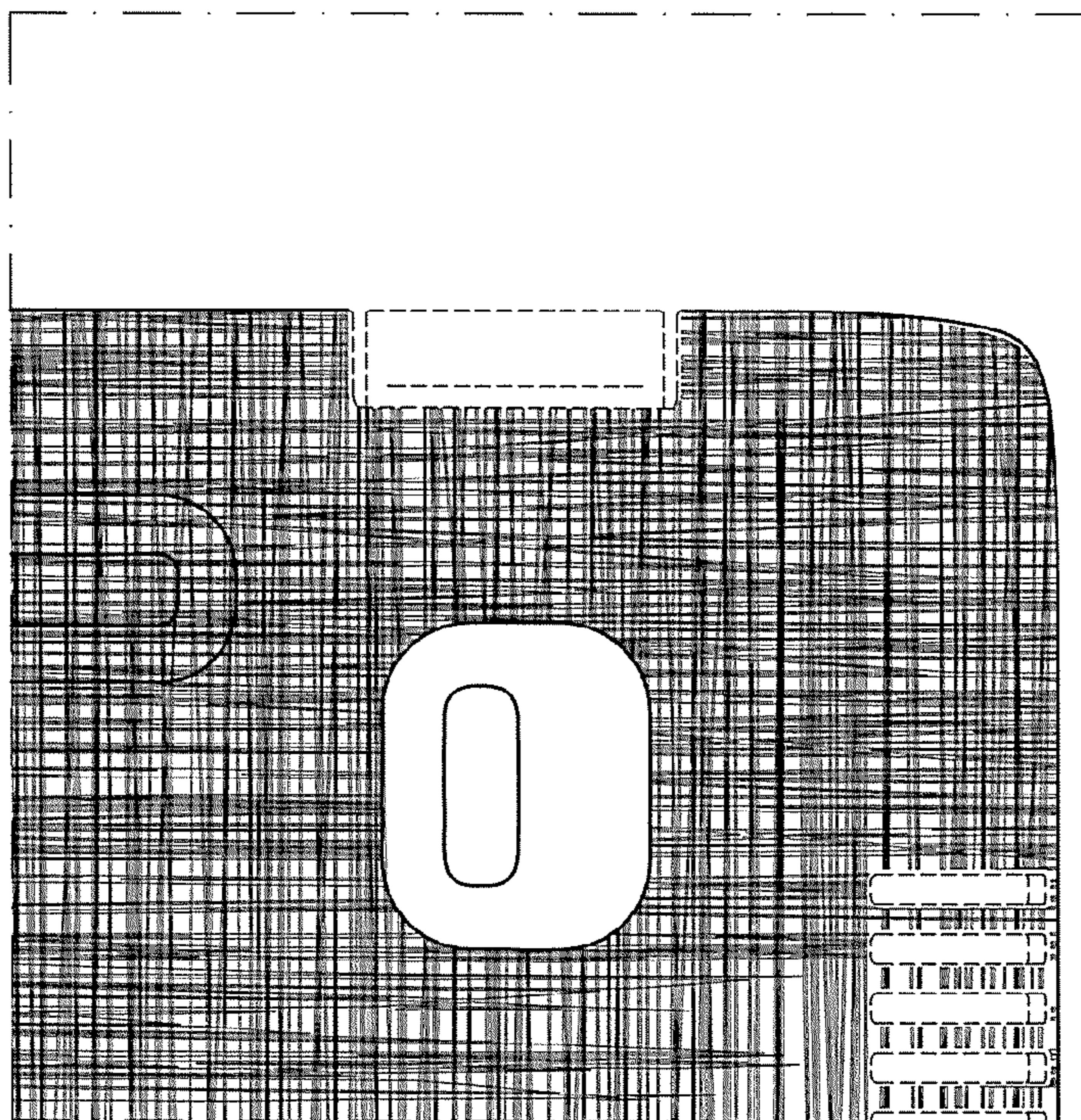

FIG. 19

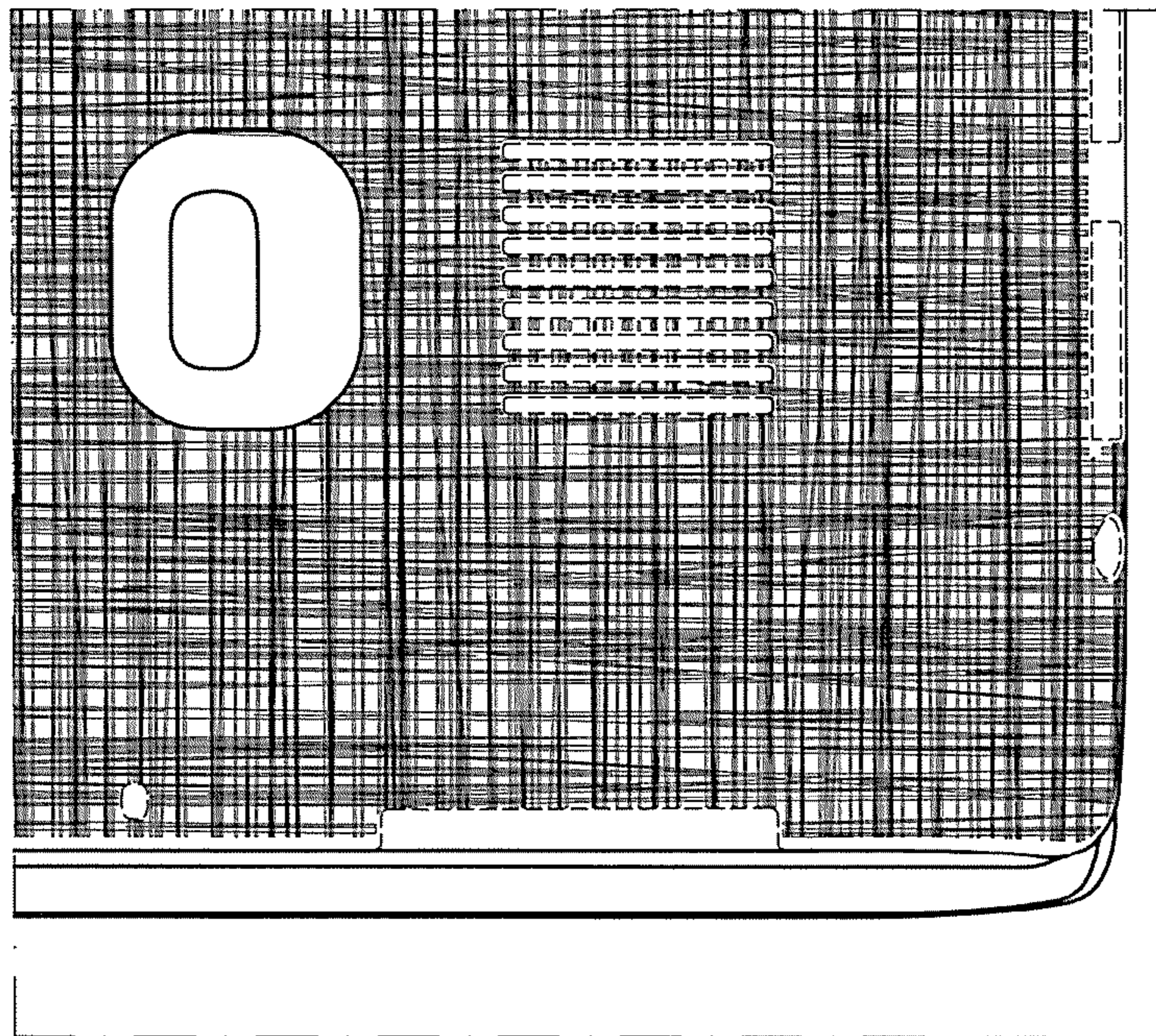

FIG. 20

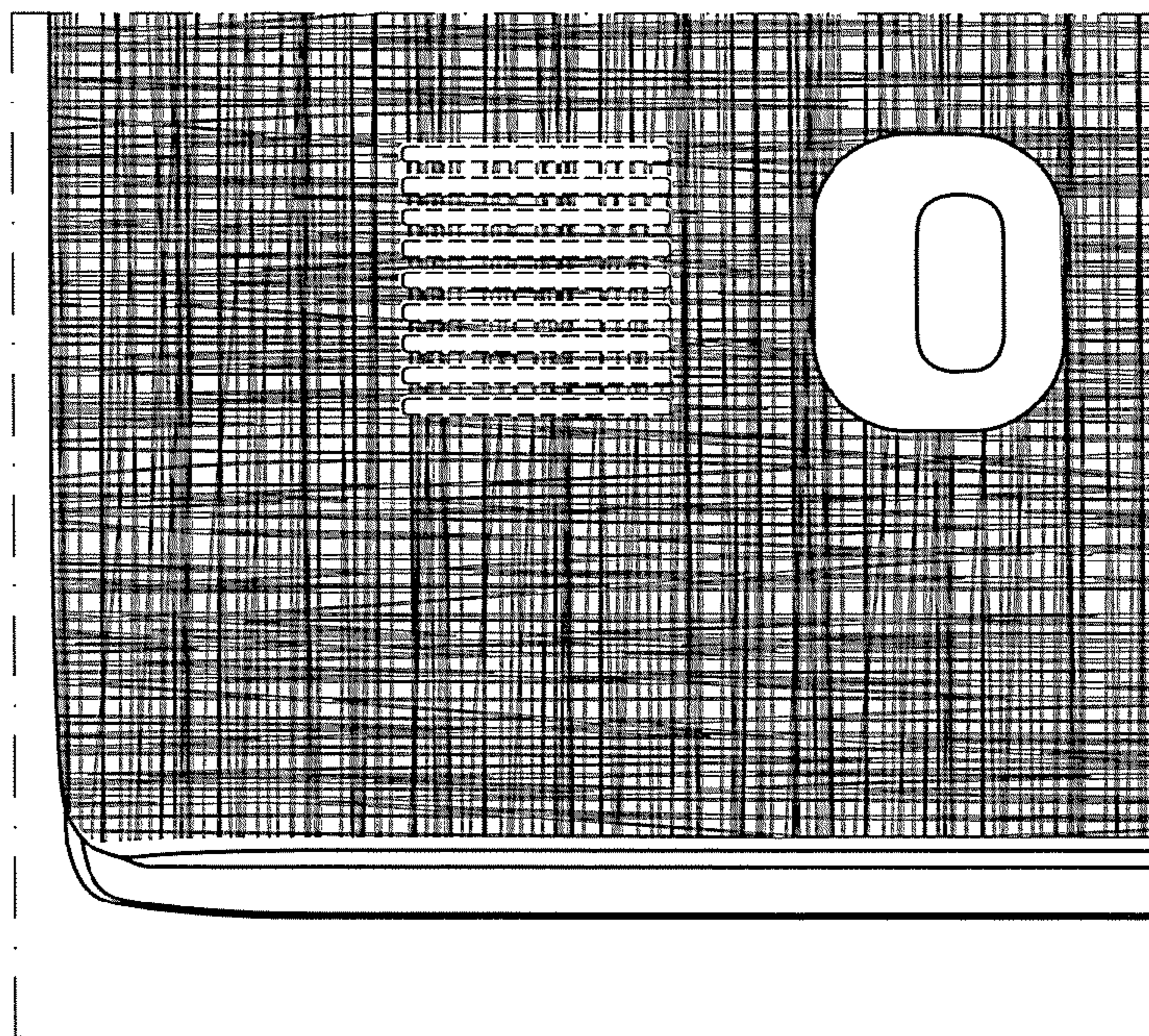

FIG. 21

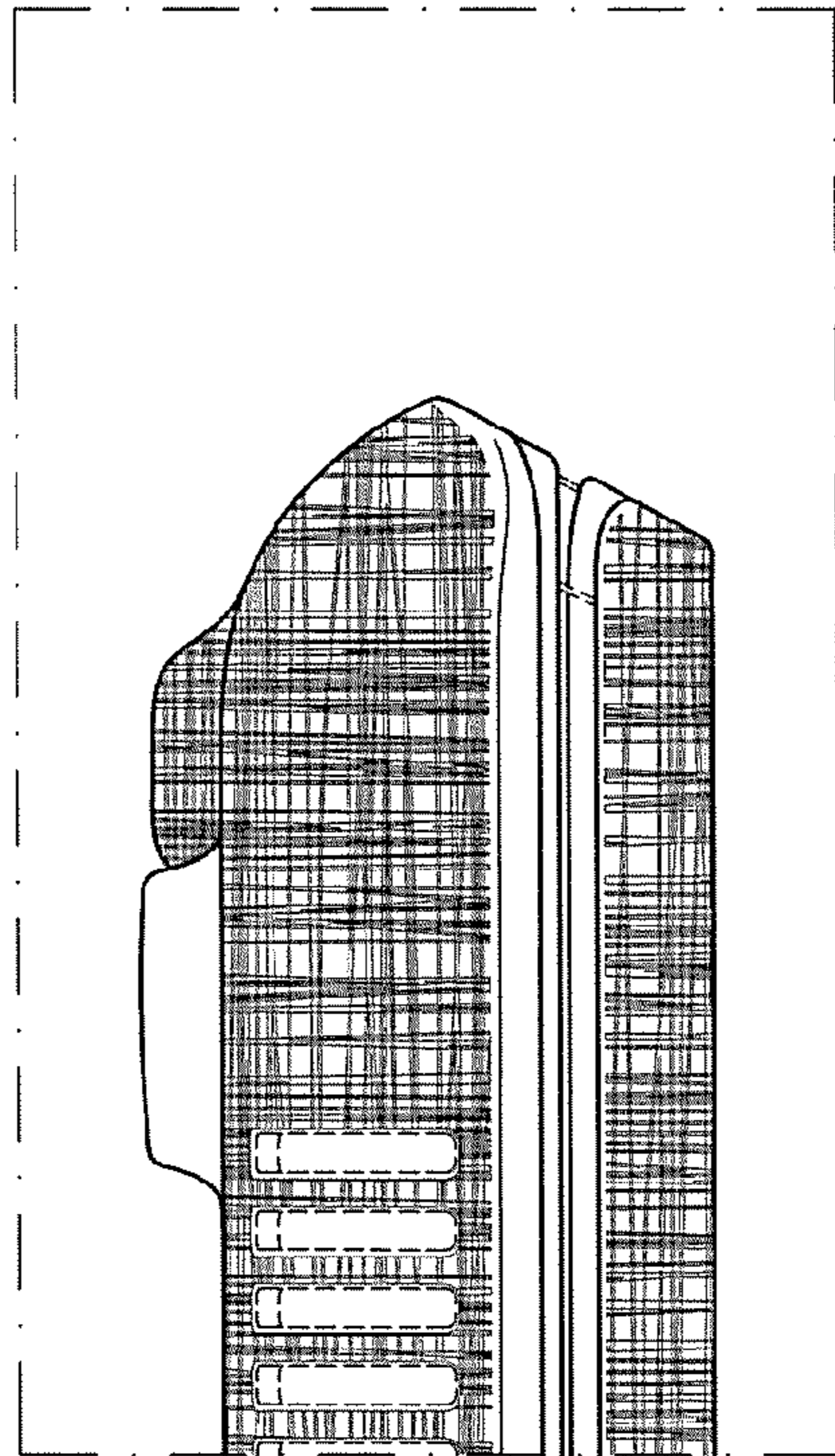

FIG. 22

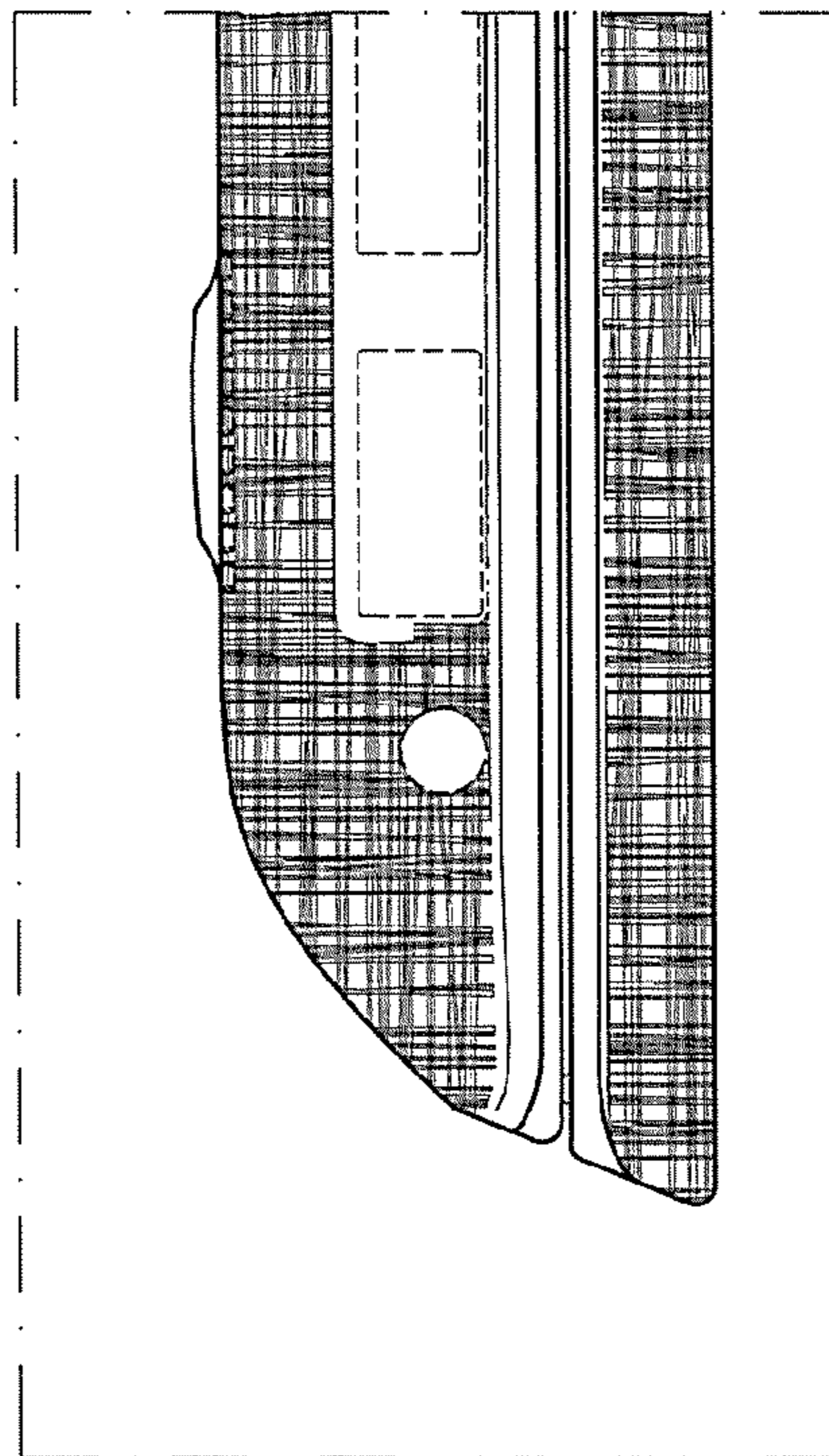

FIG. 23

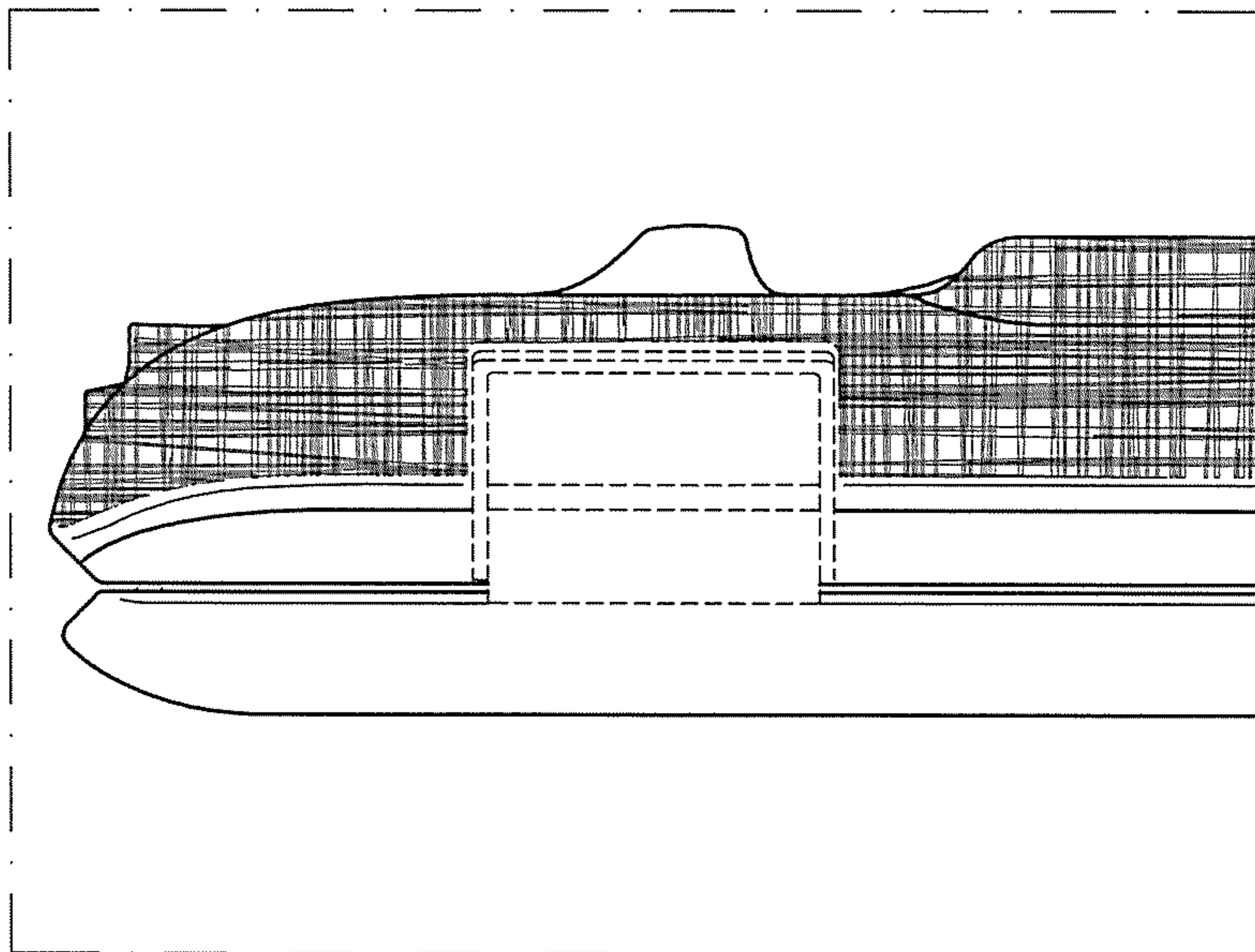

FIG. 24

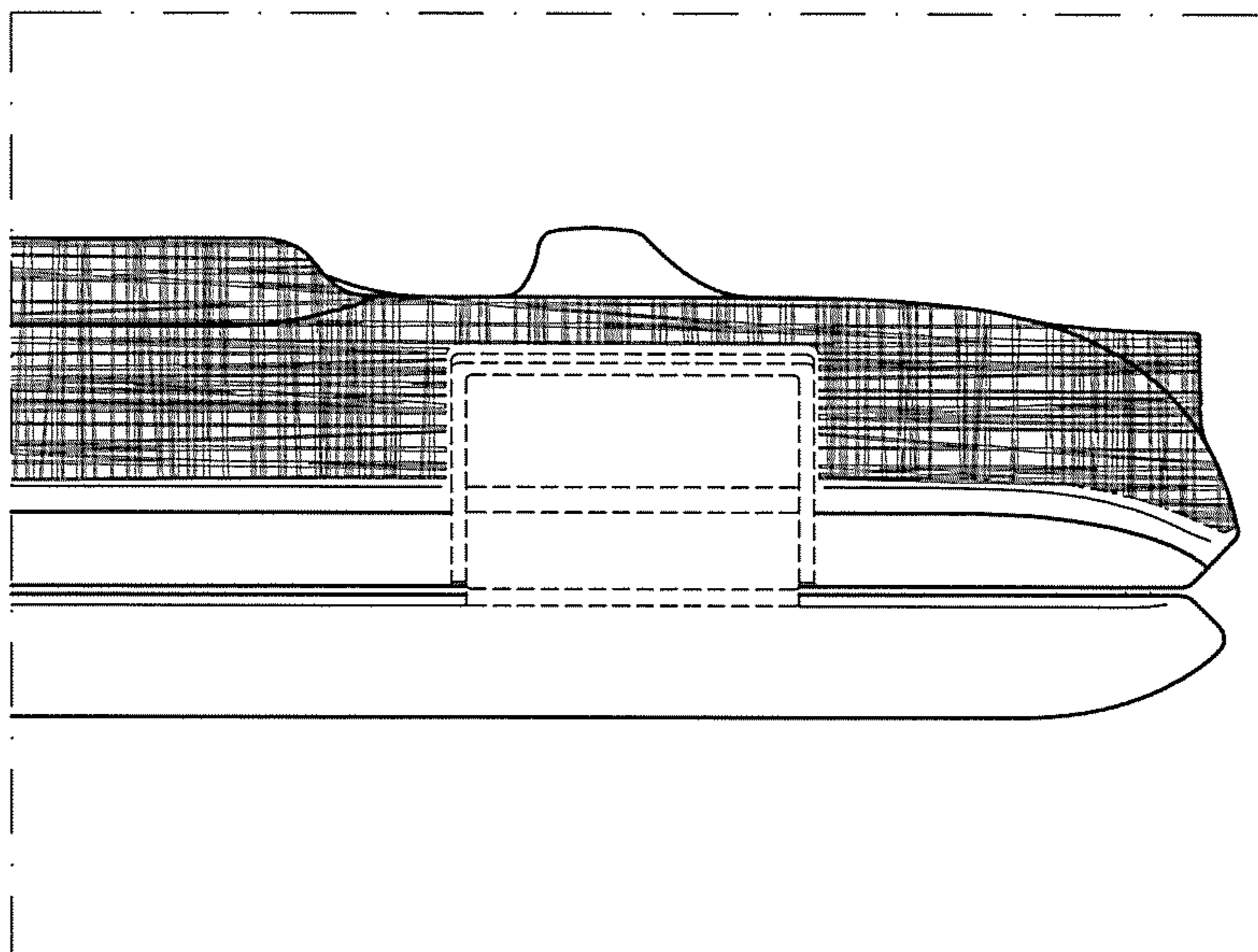

FIG. 25

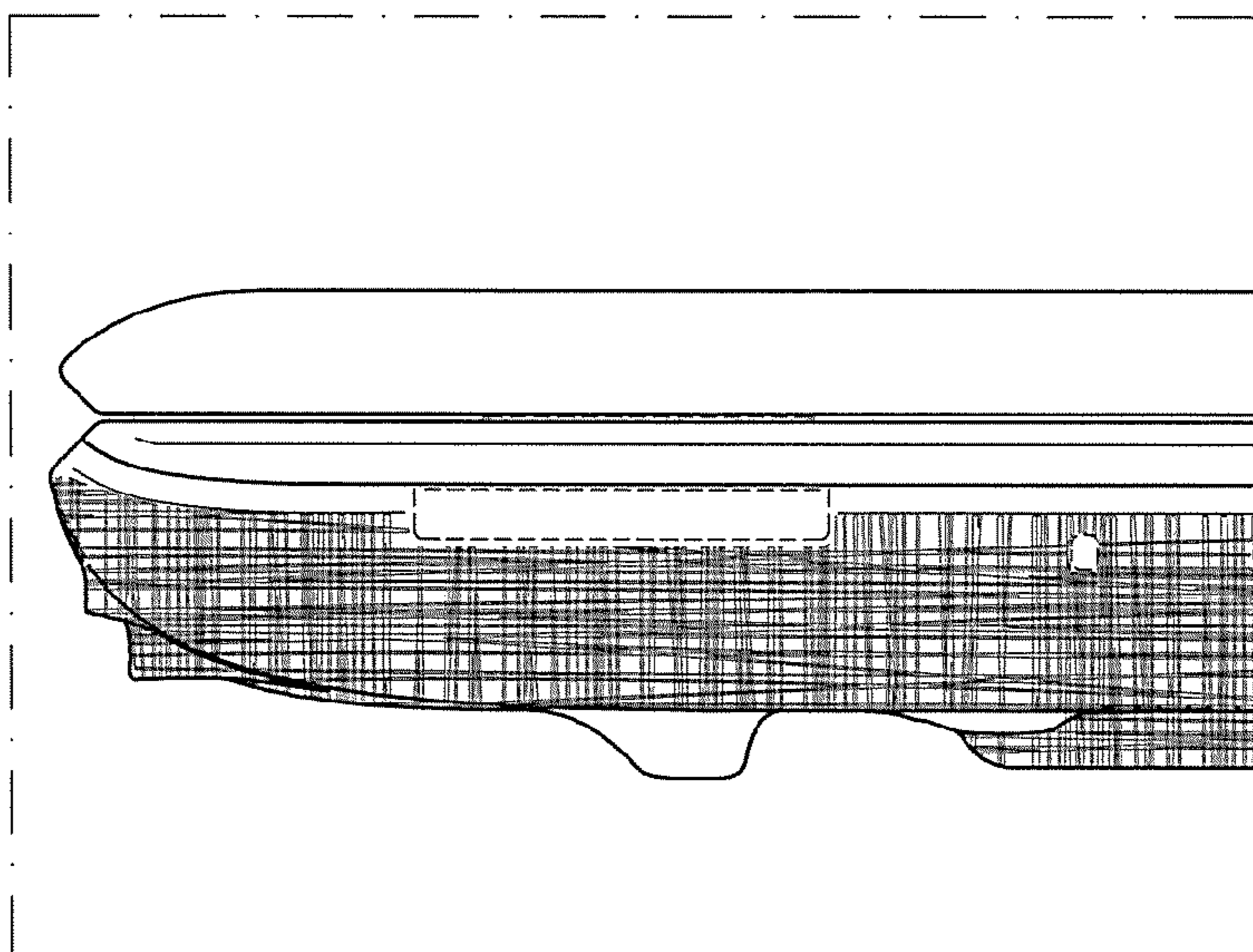

FIG. 26

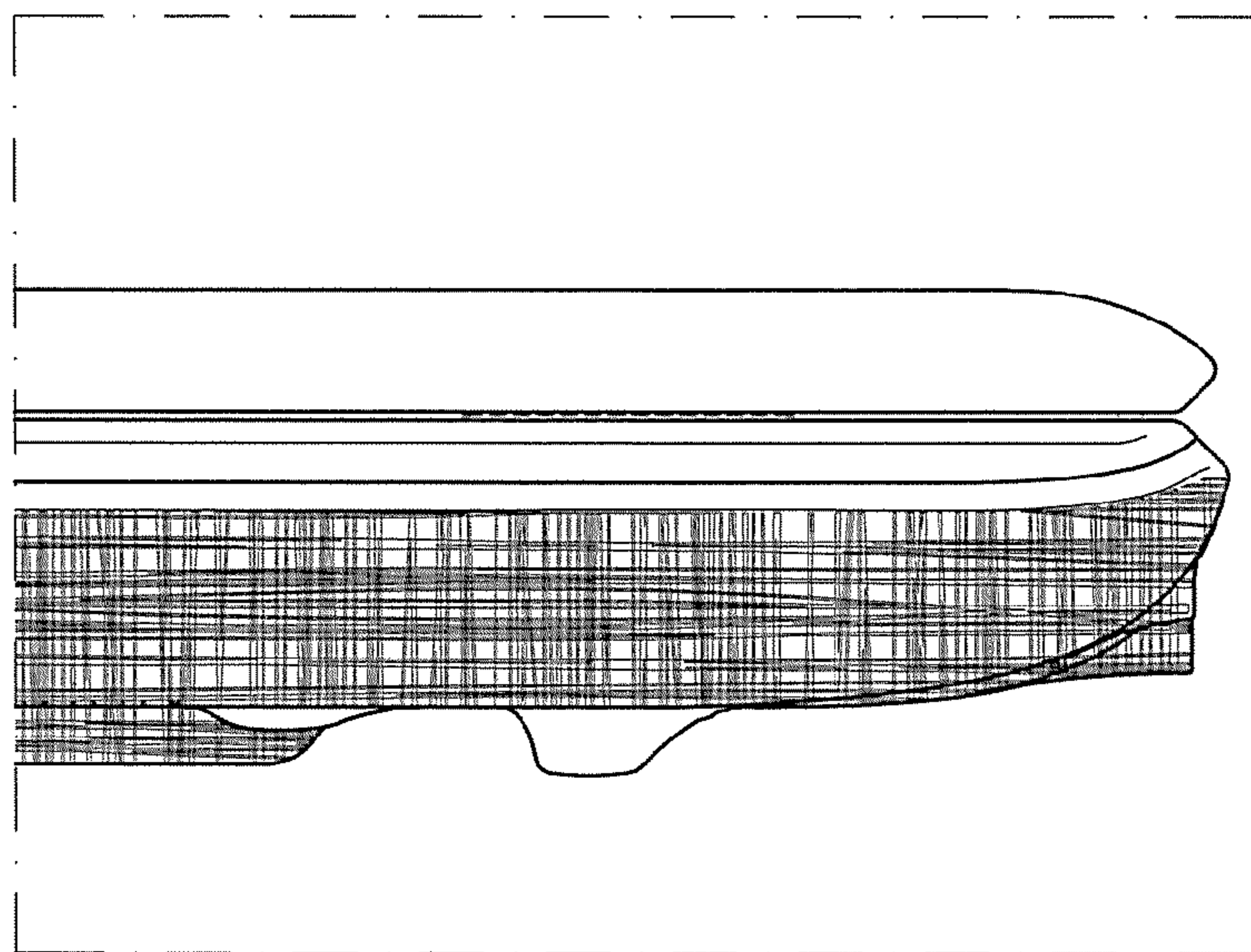

FIG. 27

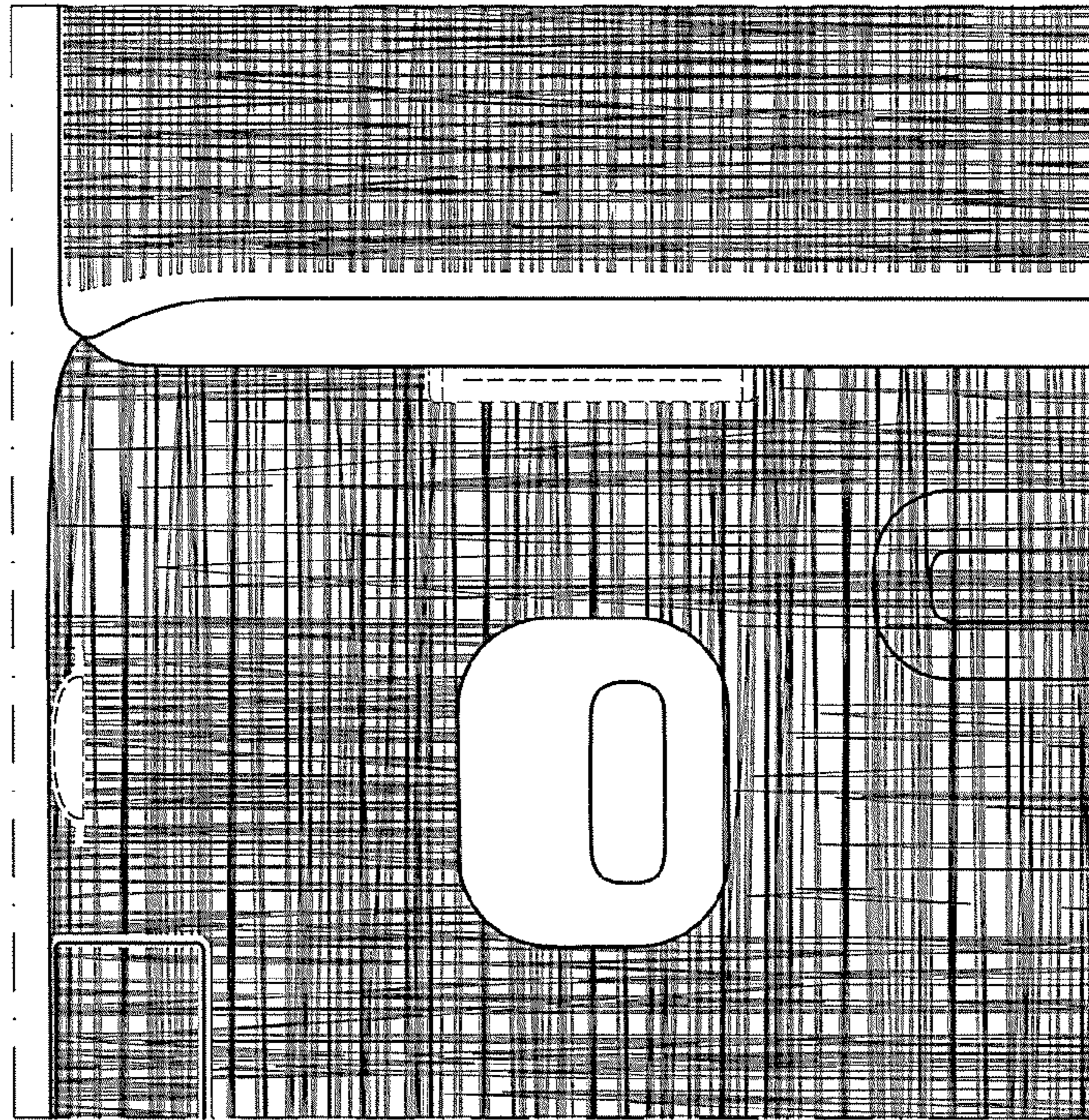

FIG. 28

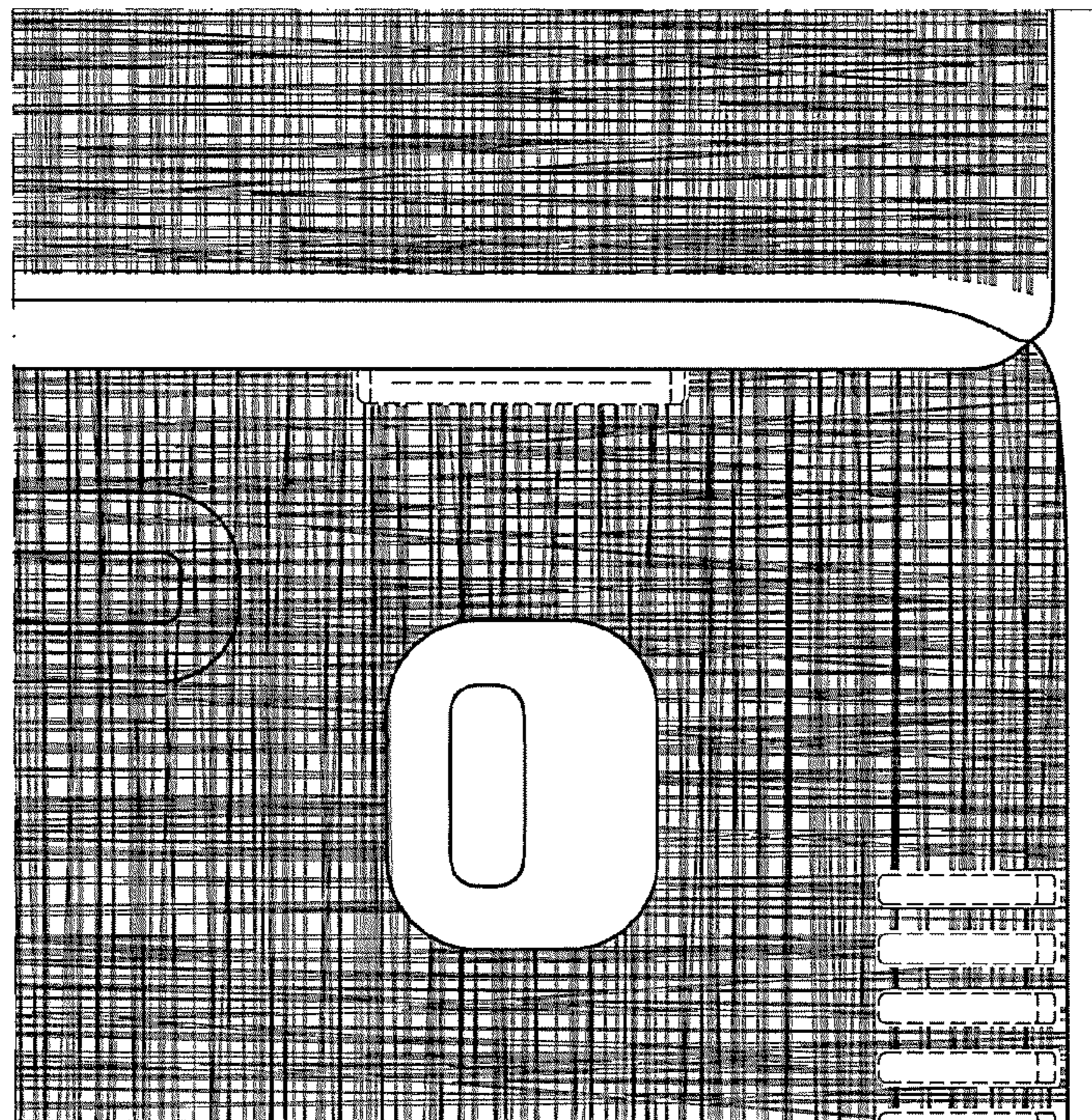

FIG. 29

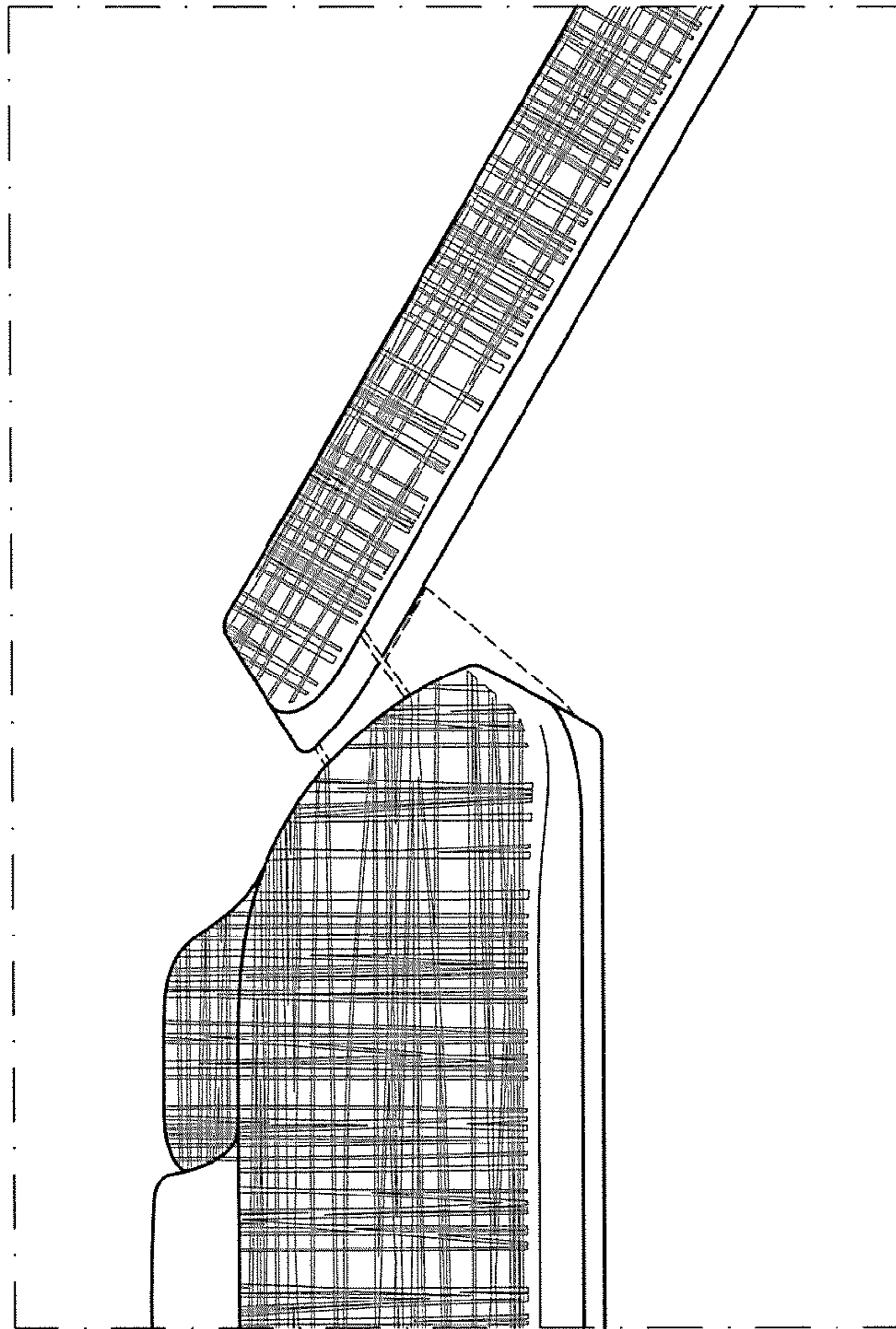

FIG. 30

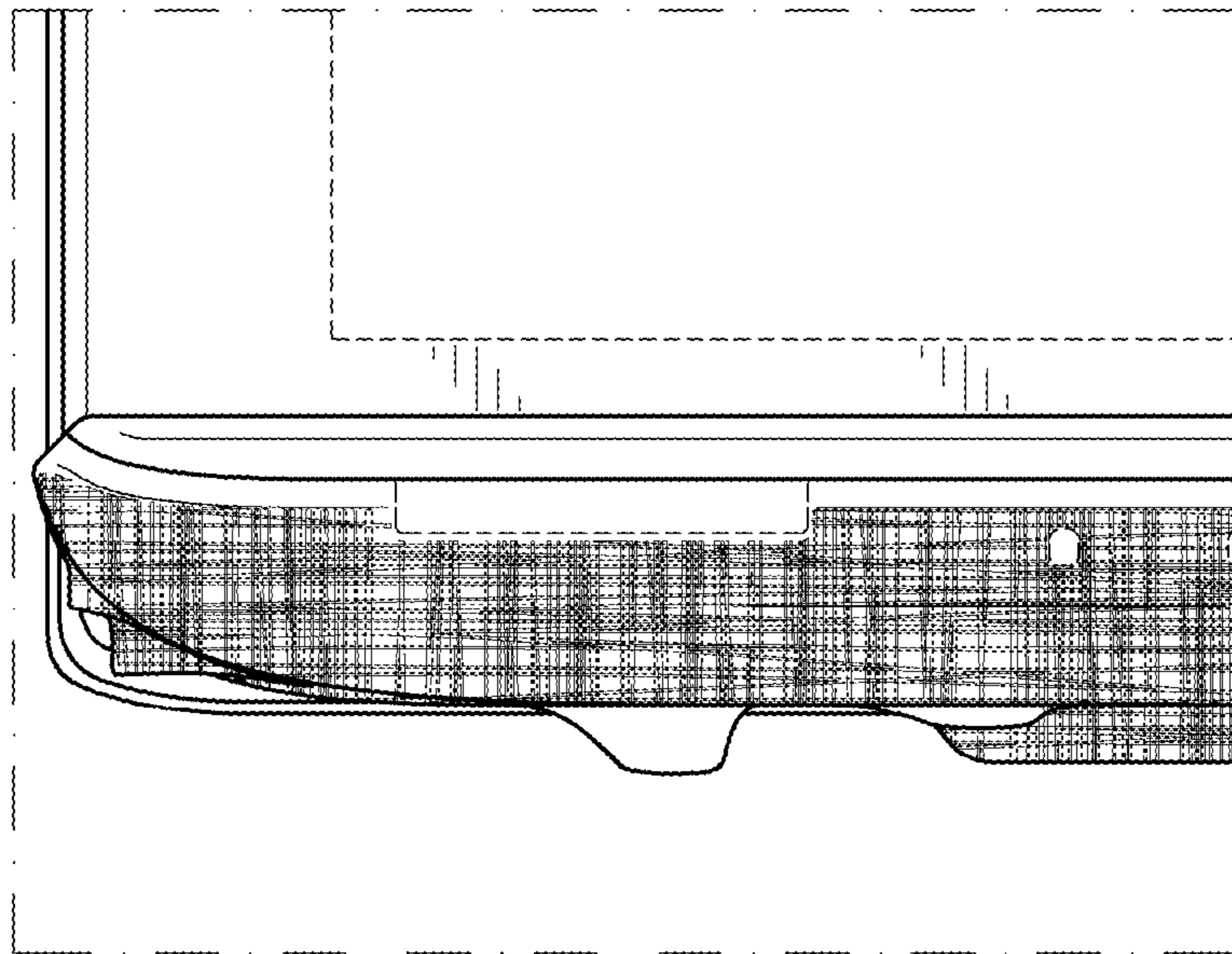

FIG. 31

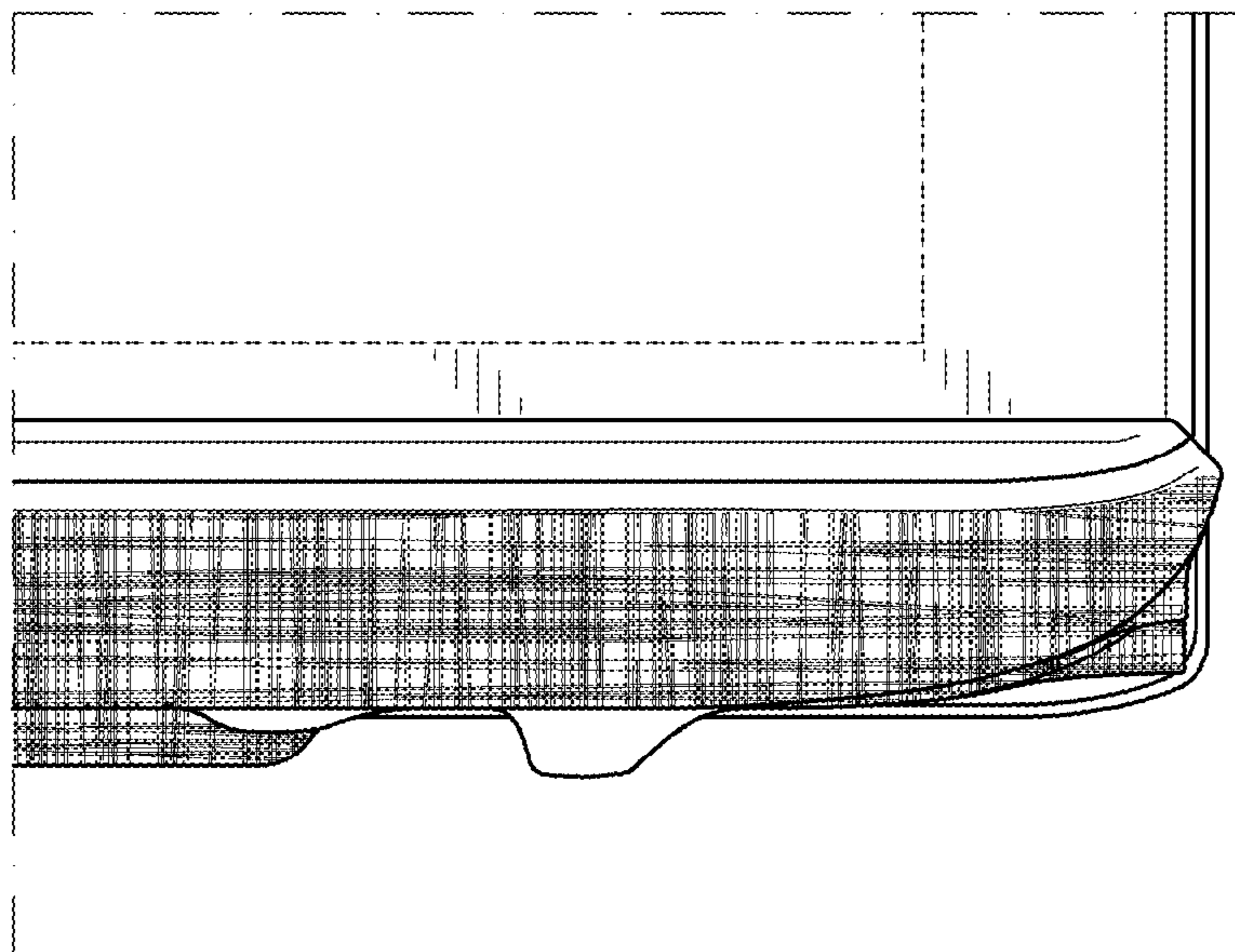

FIG. 32