



US00D770326S

(12) **United States Design Patent** (10) **Patent No.:** **US D770,326 S**
Pasco (45) **Date of Patent:** **** Nov. 1, 2016**

- (54) **BOW**
- (71) Applicant: **Benedict Pasco**, San Pedro, CA (US)
- (72) Inventor: **Dora Pasco**, San Pedro, CA (US)
- (73) Assignee: **Benedict Pasco**, San Pedro, CA (US)
- (**) Term: **14 Years**
- (21) Appl. No.: **29/525,764**
- (22) Filed: **May 1, 2015**

- D333,802 S * 3/1993 Stabler 428/4
- D338,628 S * 8/1993 Daun D11/124
- D342,464 S * 12/1993 Lardiere D11/184
- D343,508 S * 1/1994 Jones D2/606
- D371,891 S * 7/1996 Seaton D2/606
- D390,808 S * 2/1998 Balde D11/121
- D390,809 S * 2/1998 Etzion D11/133
- D402,918 S * 12/1998 Pacheco D11/184
- D413,542 S * 9/1999 Guarino D11/74
- D421,665 S * 3/2000 Farmer-Abney D11/184
- D428,531 S * 7/2000 Falloon D28/41
- D453,863 S * 2/2002 Kang D1/125
- D476,134 S * 6/2003 Miller D2/609

(Continued)

Related U.S. Application Data

- (63) Continuation of application No. 29/482,630, filed on Feb. 20, 2014, now Pat. No. Des. 731,354.
- (51) **LOC (10) Cl.** **11-02**
- (52) **U.S. Cl.**
USPC **D11/184**
- (58) **Field of Classification Search**
USPC D11/184, 66, 74, 131; D2/730, 762,
D2/842, 606, 895; D28/39, 41
CPC A41D 25/02; A41D 25/027; A41D 27/08;
D04D 7/105; D04D 7/10
See application file for complete search history.

Primary Examiner — John Windmuller

Assistant Examiner — Steven Czyz

(74) *Attorney, Agent, or Firm* — Knobbe Martens Olson & Bear LLP

(57) **CLAIM**

The ornamental design for a bow, as shown and described.

DESCRIPTION

FIG. 1 is a front elevational view of a first of a bow showing my new design.
 FIG. 2 is a front perspective thereof.
 FIG. 3 is a rear perspective thereof.
 FIG. 4 is a top plan view thereof.
 FIG. 5 is a bottom plan view thereof.
 FIG. 6 is a right side elevational view thereof.
 FIG. 7 is a left side elevational view thereof.
 FIG. 8 is a is a front elevational view of one of the crystals attached to the bow shown separately for ease of disclosure.
 FIG. 9 is a front perspective view thereof shown separately for ease of disclosure; and,
 FIG. 10 is a side view thereof shown separately for ease of disclosure.
 The broken lines depict portions of the article that form no part of the claimed design. The crystals shown in FIGS. 8-10 are shiny and transparent.

(56) **References Cited**

U.S. PATENT DOCUMENTS

- 1,658,634 A * 2/1928 Friedman A41D 25/001
2/151
- 1,676,291 A * 7/1928 Schultz A41D 25/04
2/151
- 1,800,729 A * 4/1931 Hodges A41D 25/04
2/151
- D159,395 S * 7/1950 Schlossberg et al. D11/74
- D163,537 S * 6/1951 Moses et al. D2/606
- 2,578,269 A * 12/1951 Sinton A41D 25/02
2/151
- D306,215 S * 2/1990 Bell D11/74
- D313,373 S * 1/1991 Taylor 428/4
- D333,639 S * 3/1993 Matan D11/184

1 Claim, 8 Drawing Sheets

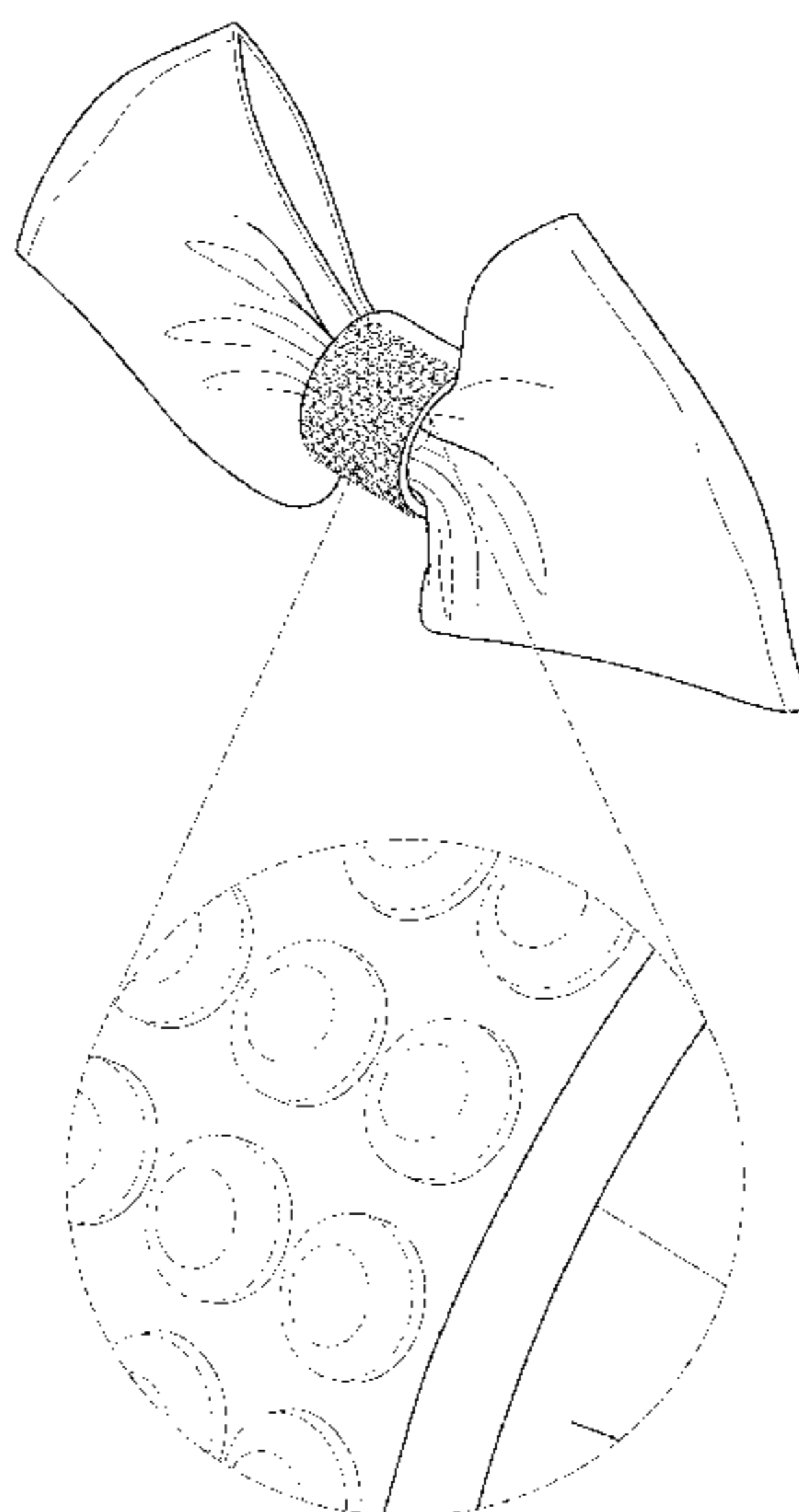

(56)

References Cited

U.S. PATENT DOCUMENTS

D502,571 S * 3/2005 Croes-Stoffer D28/41
D507,508 S * 7/2005 Brownell D11/184
D523,187 S * 6/2006 Bazar D30/152
D526,442 S * 8/2006 Kim D28/41
D534,333 S * 1/2007 Jones D2/606
D618,587 S * 6/2010 Weldon D11/215

D667,751 S * 9/2012 Dunn D11/184
D688,441 S * 8/2013 Kim D2/501
D731,354 S * 6/2015 Pasco D11/184
D734,223 S * 7/2015 Grilley D12/177
D740,166 S * 10/2015 Glass D11/184
2002/0086121 A1 * 7/2002 Shulman B32B 27/12
428/4
2003/0096066 A1 * 5/2003 Clark D04D 7/10
428/4

* cited by examiner

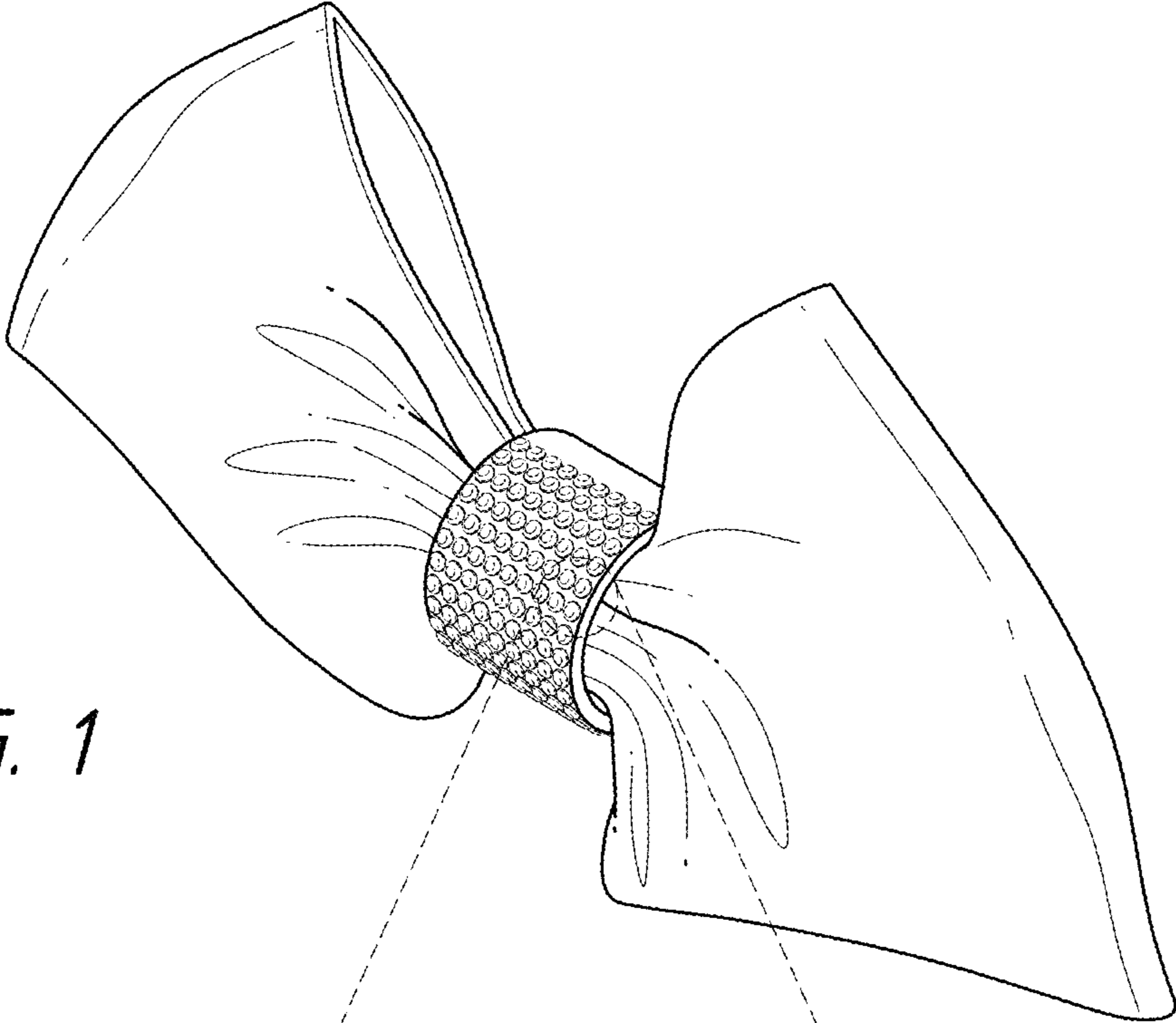
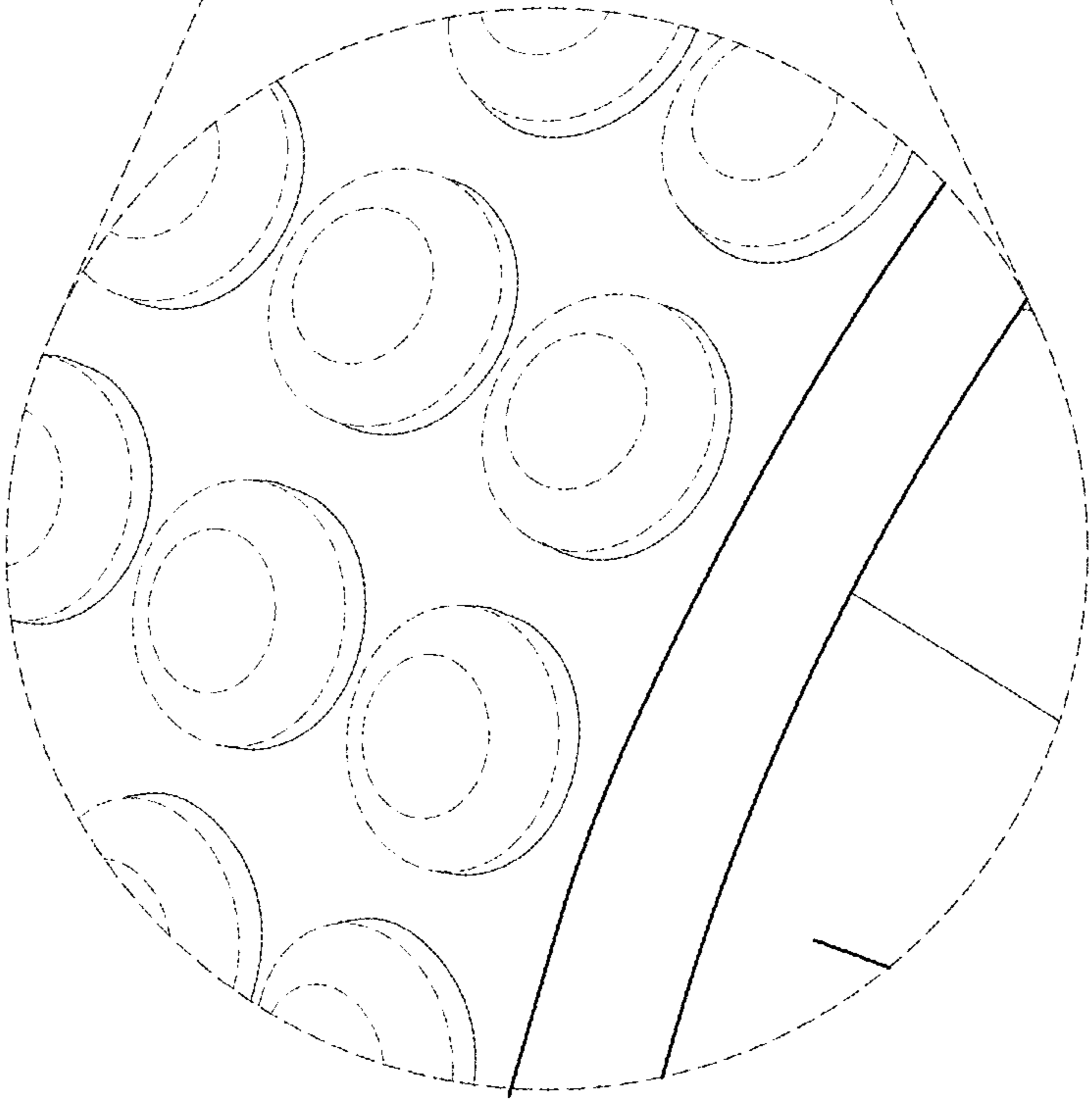

FIG. 1



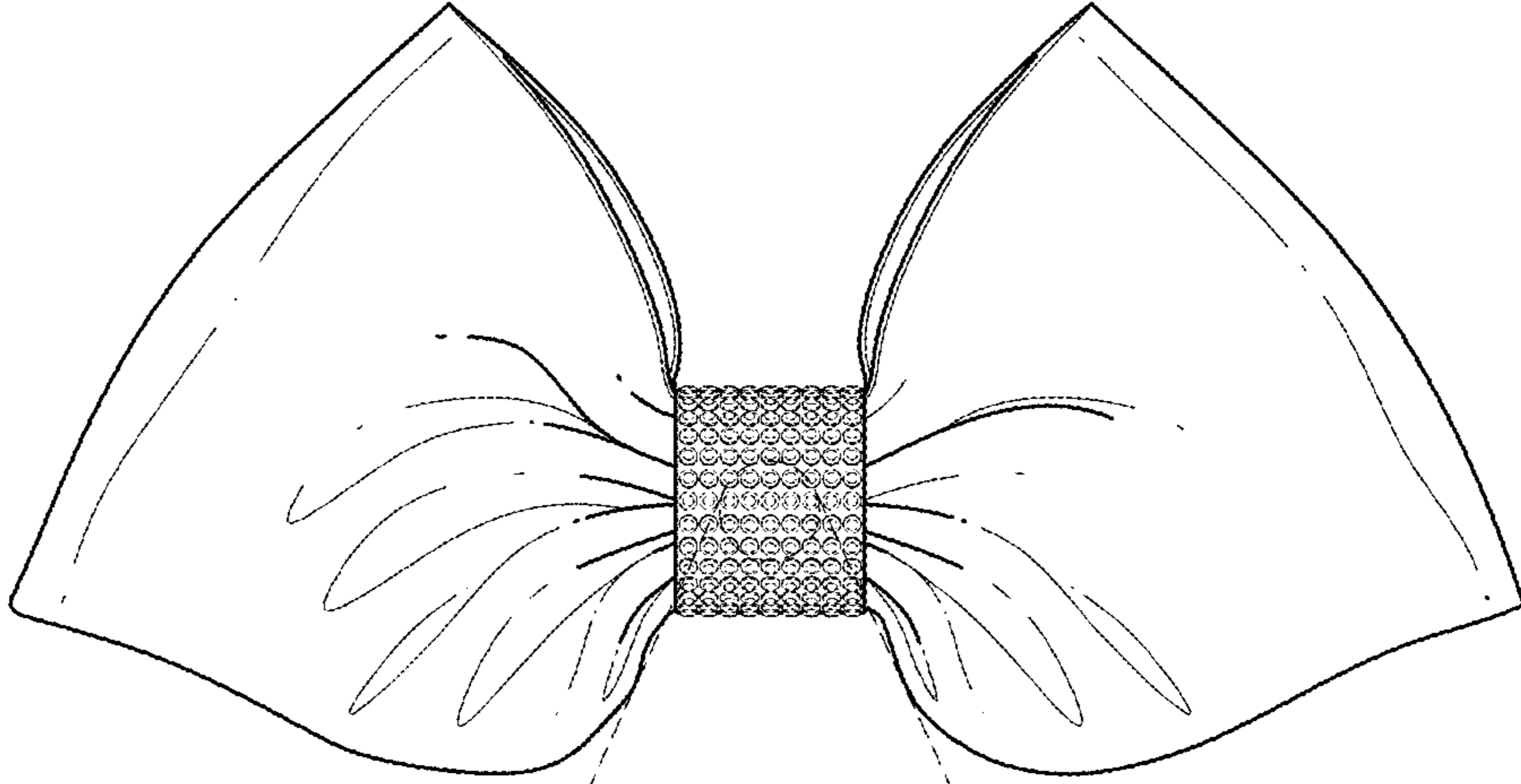
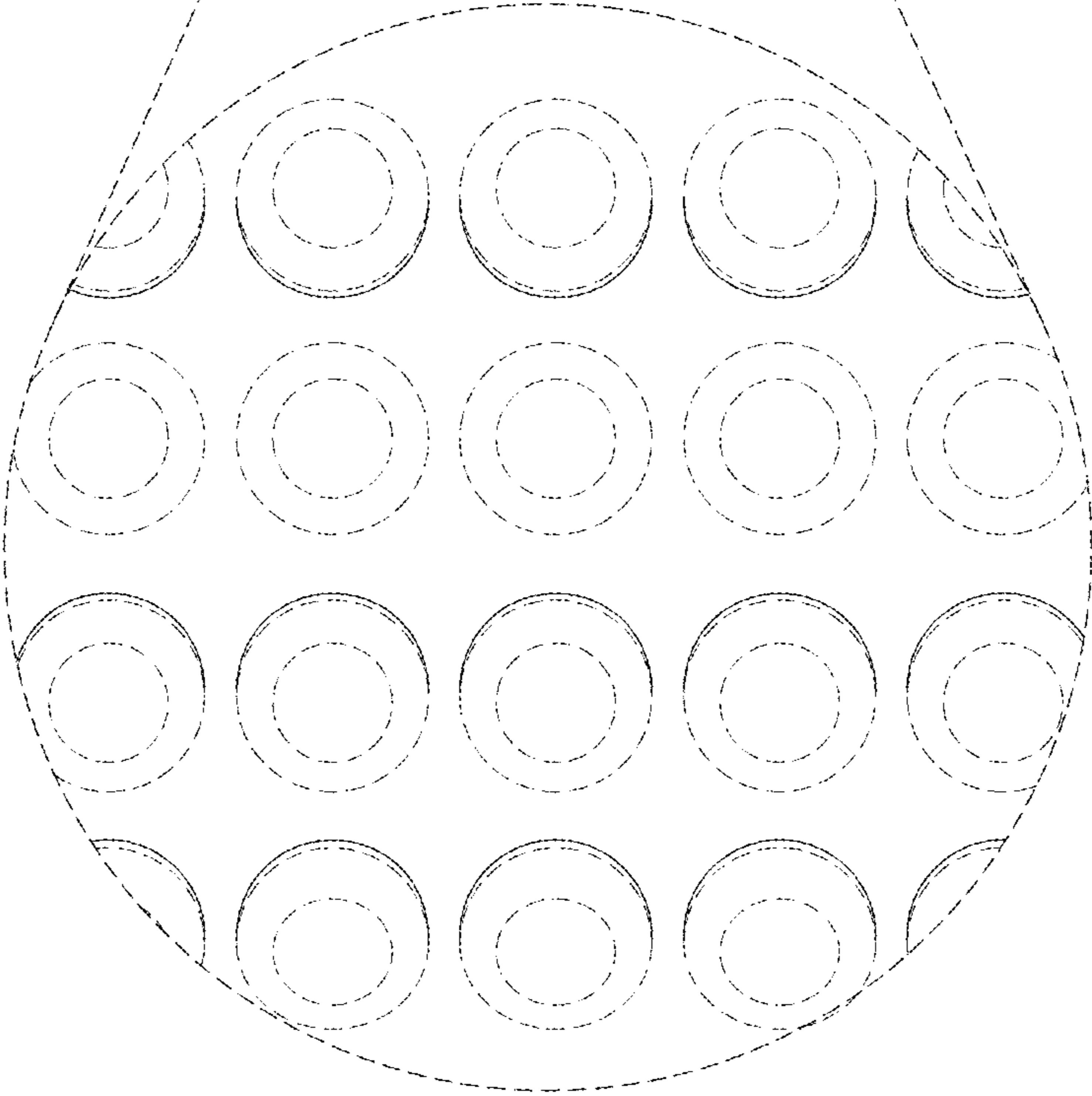

FIG. 2



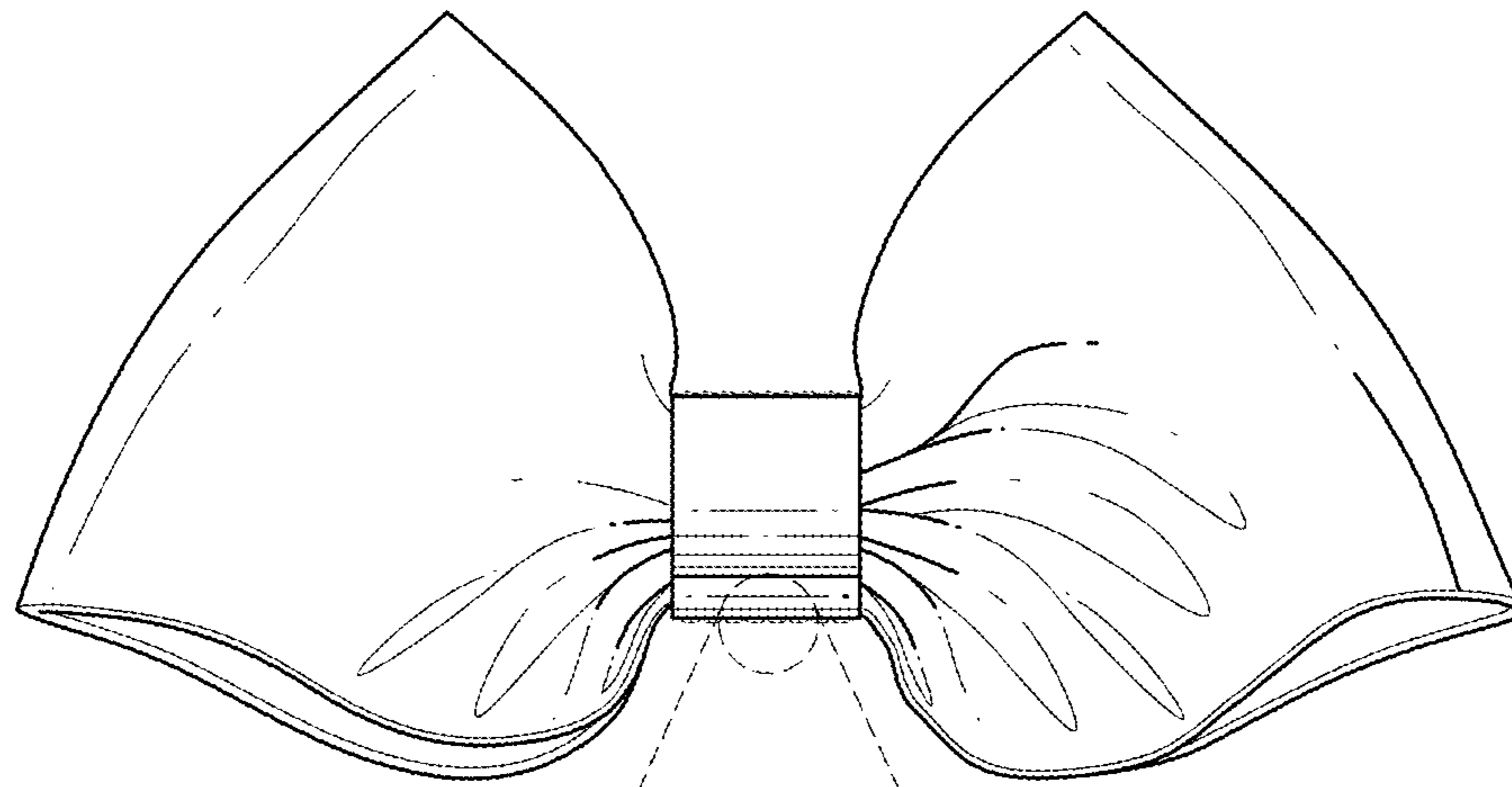
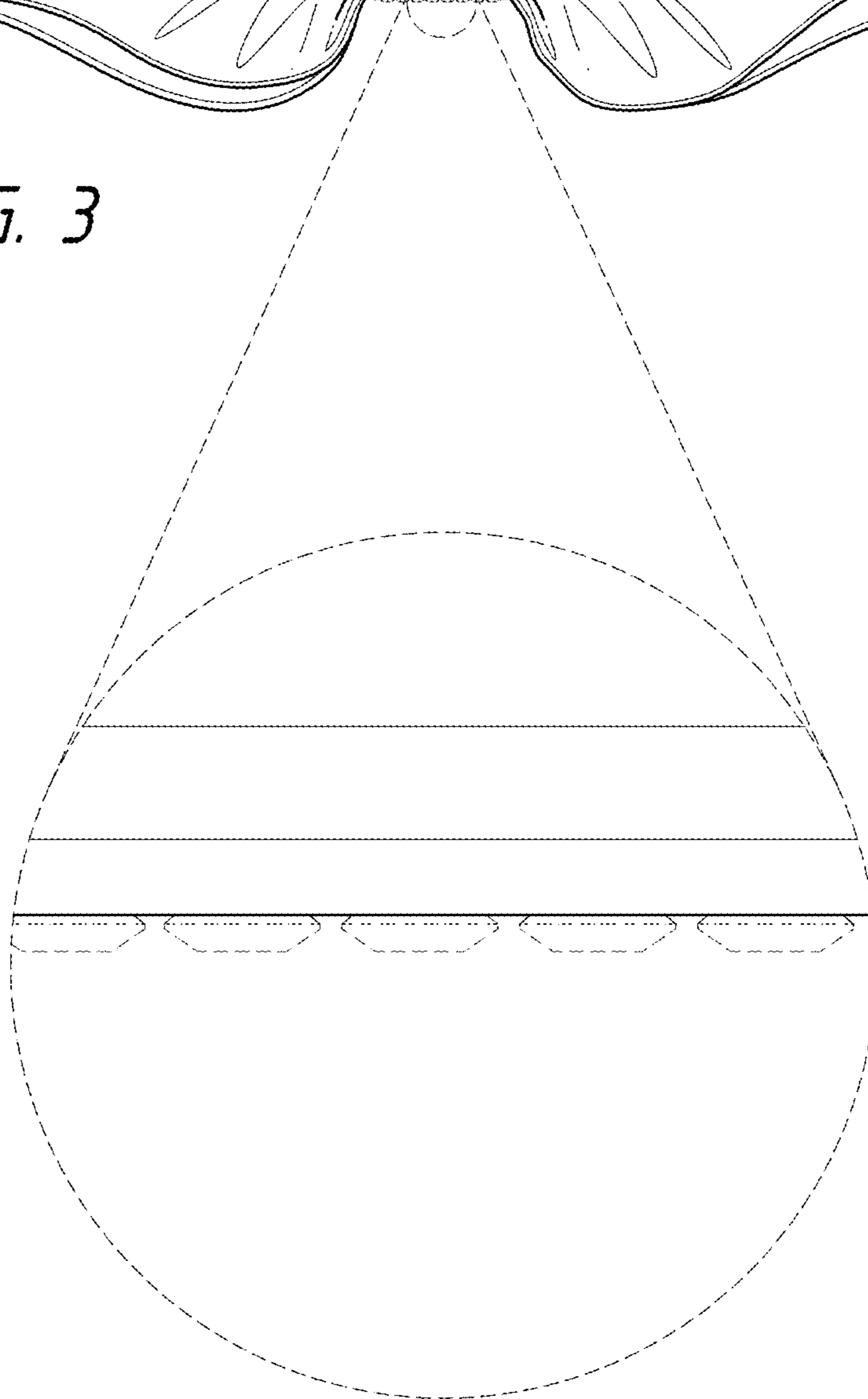

FIG. 3



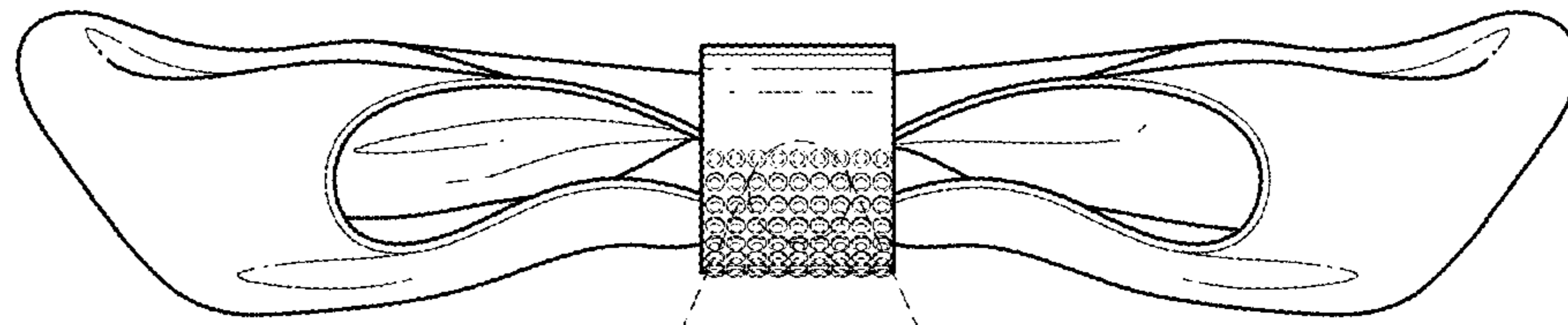
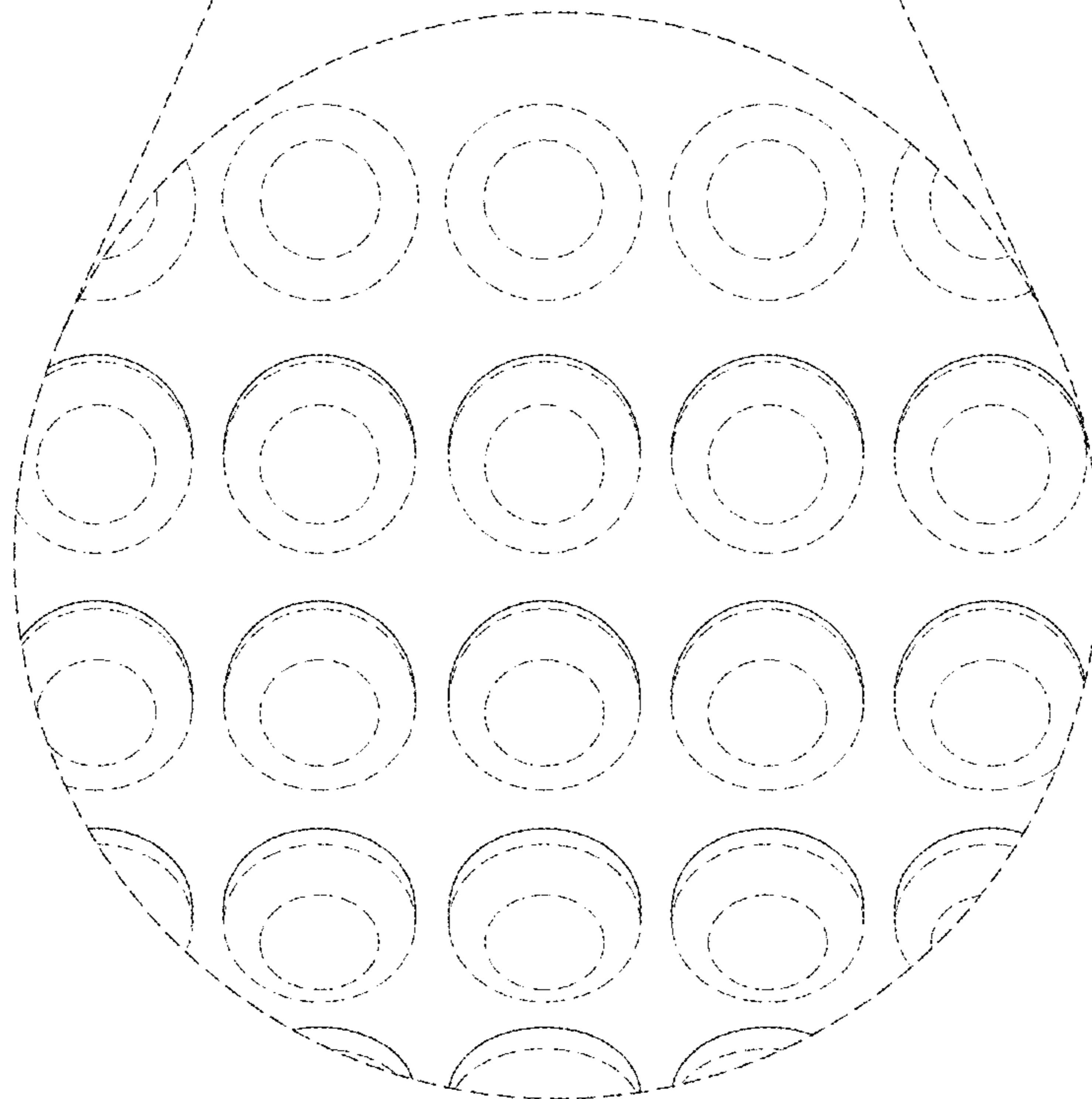

FIG. 4



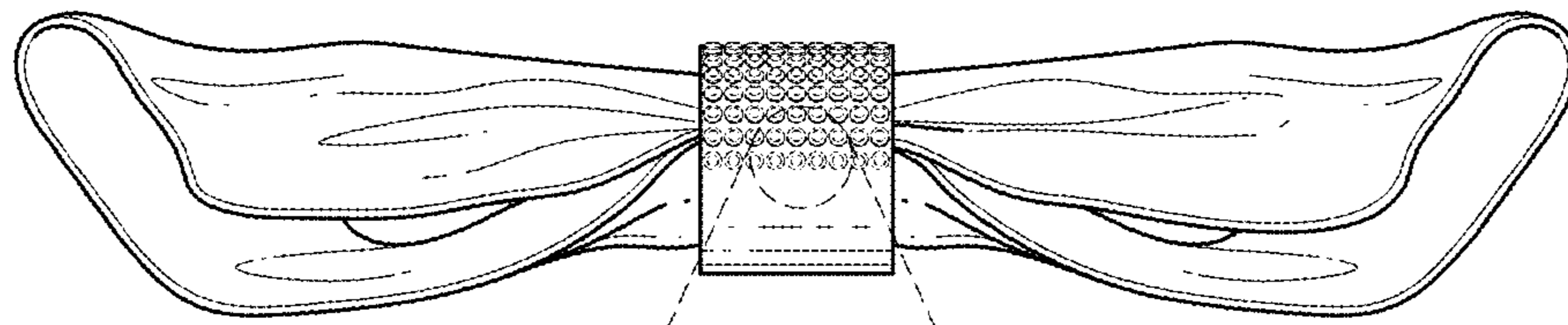
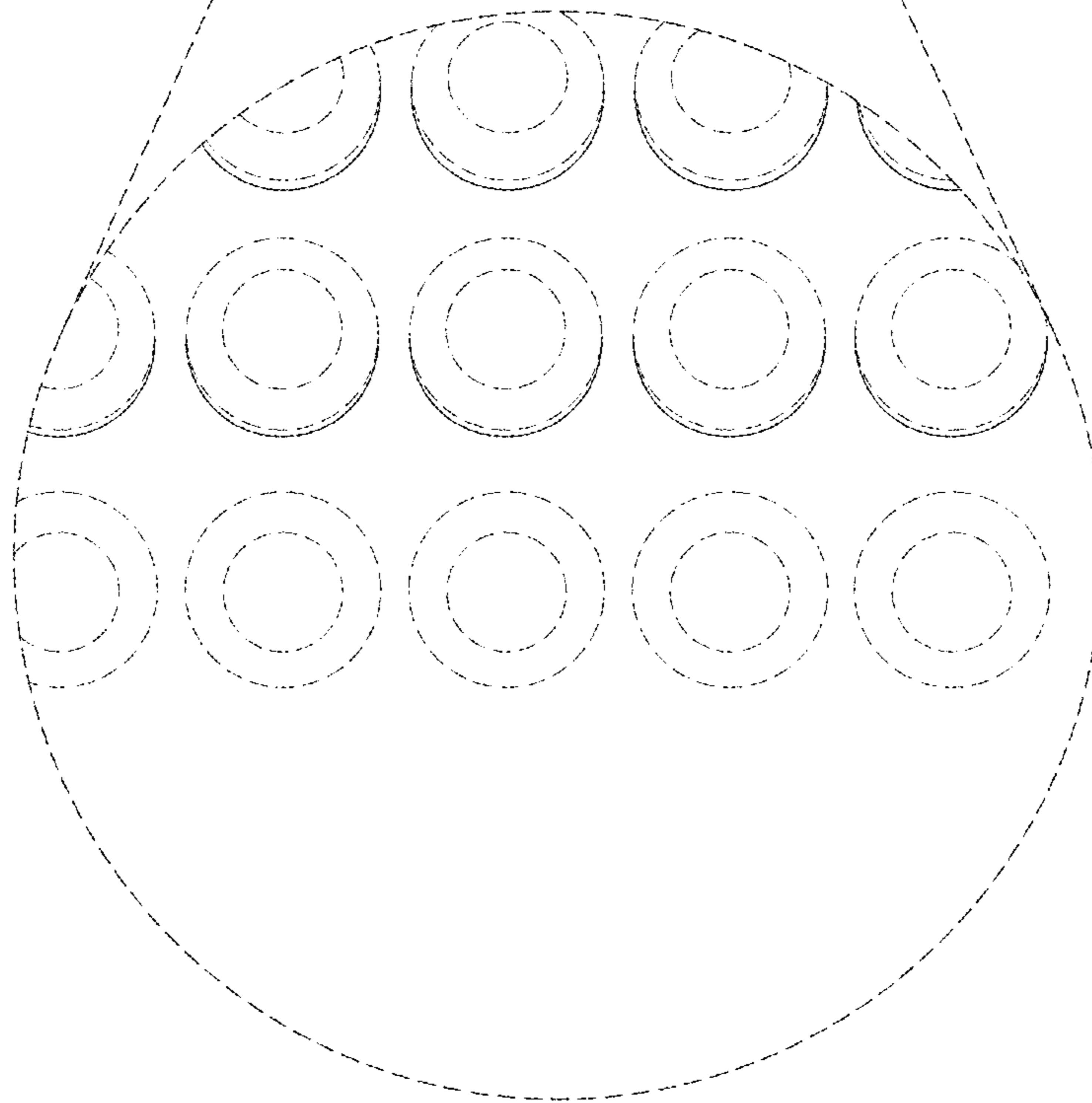
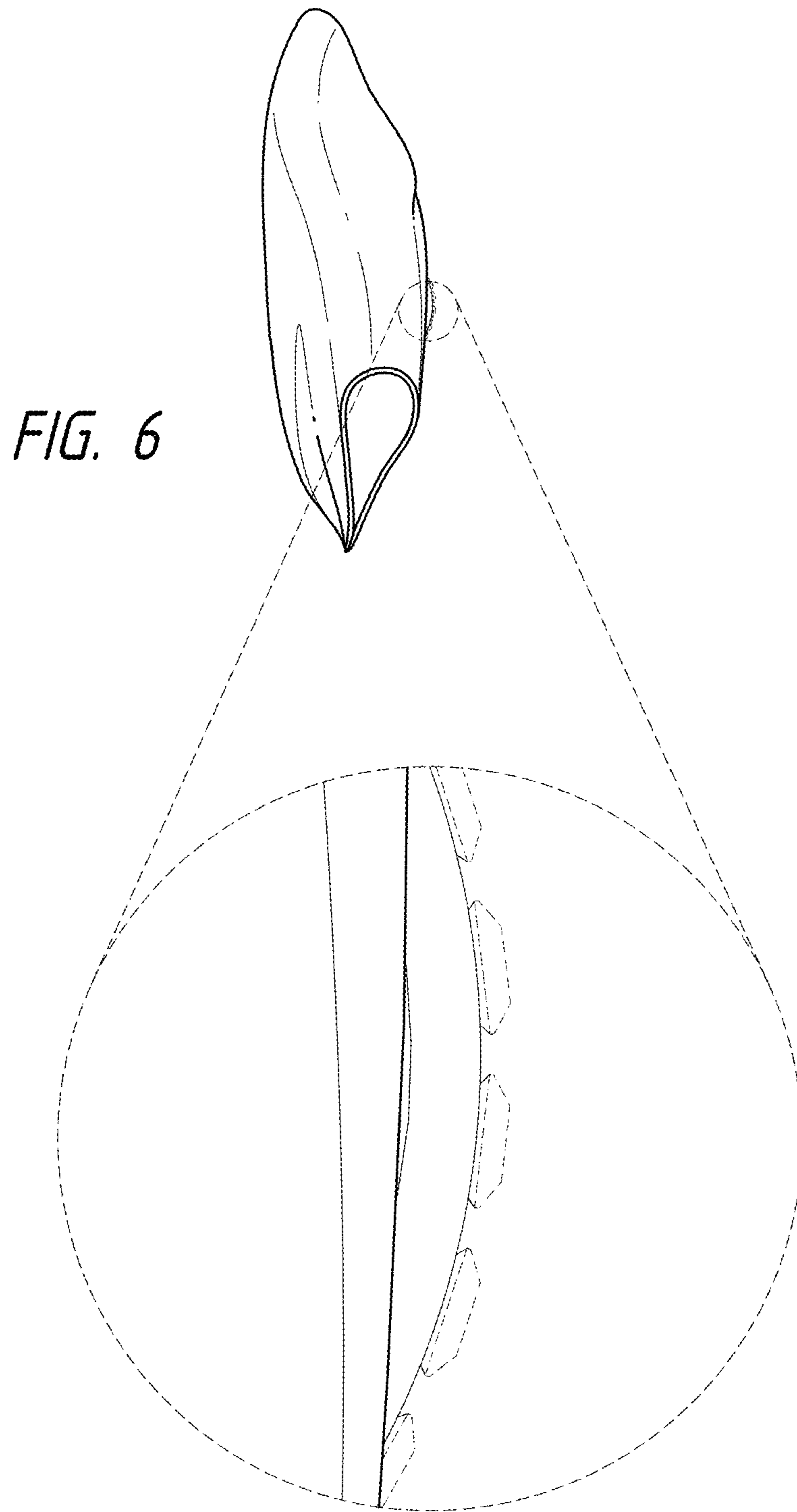

FIG. 5





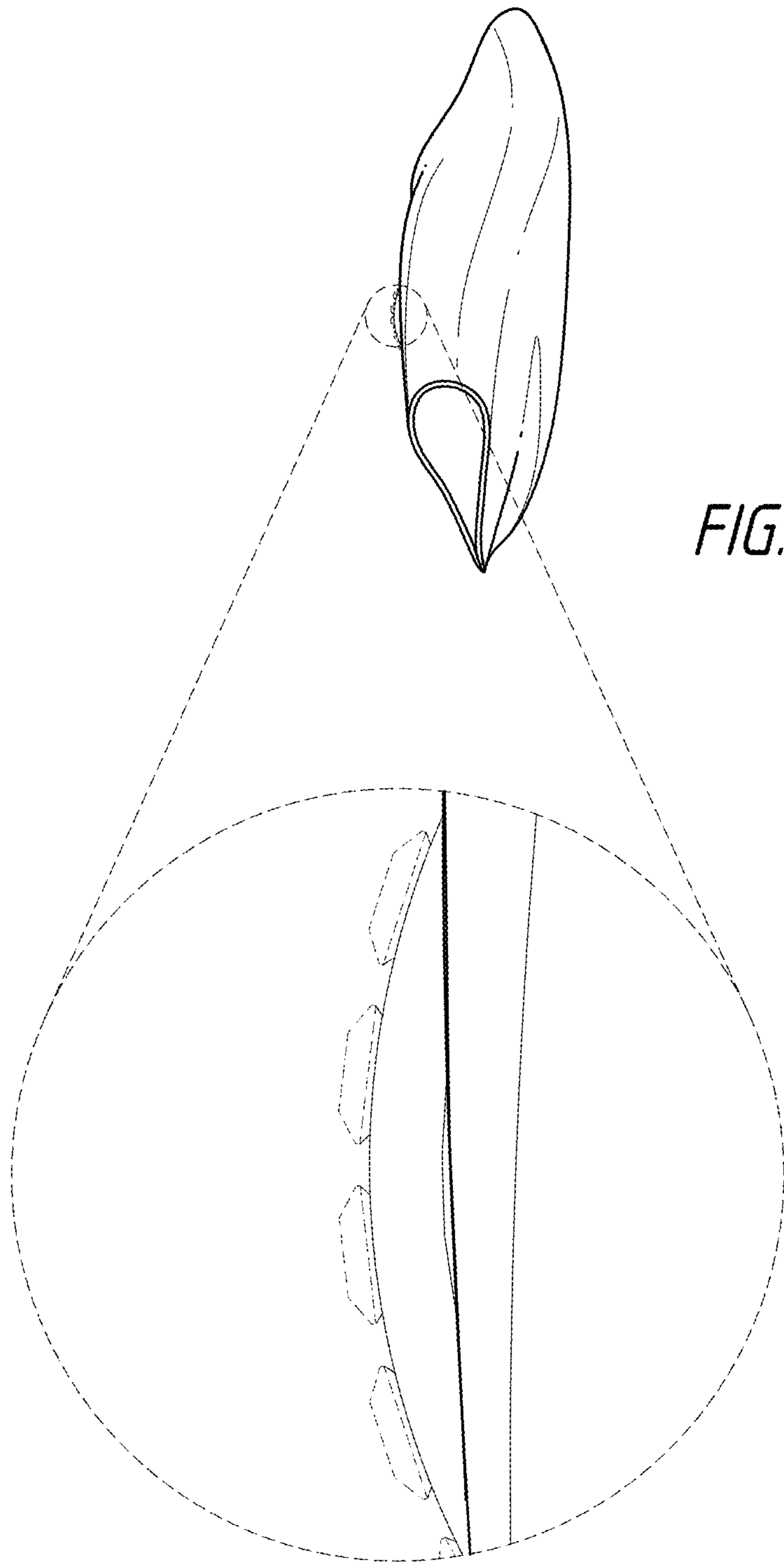

FIG. 7

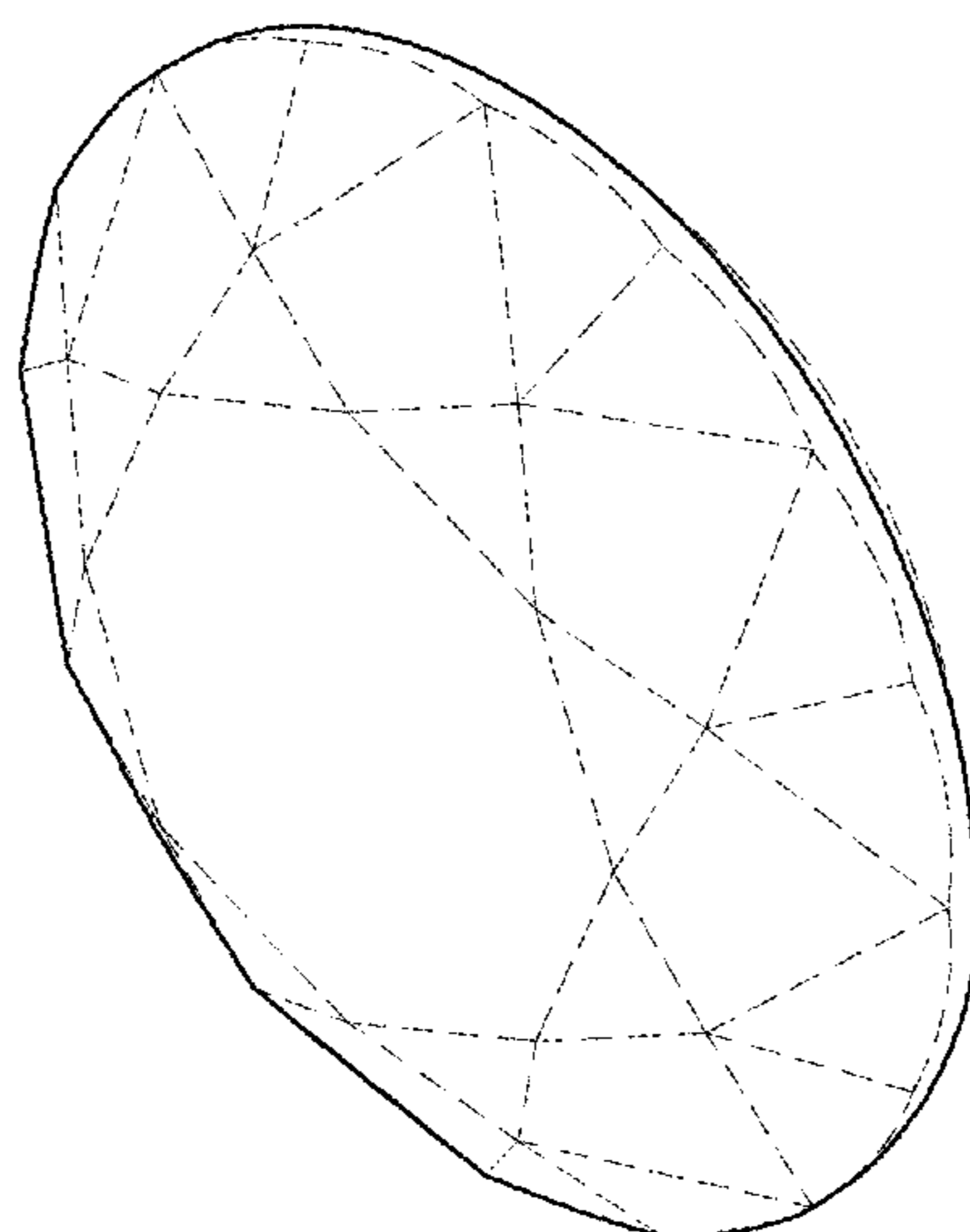

FIG. 8

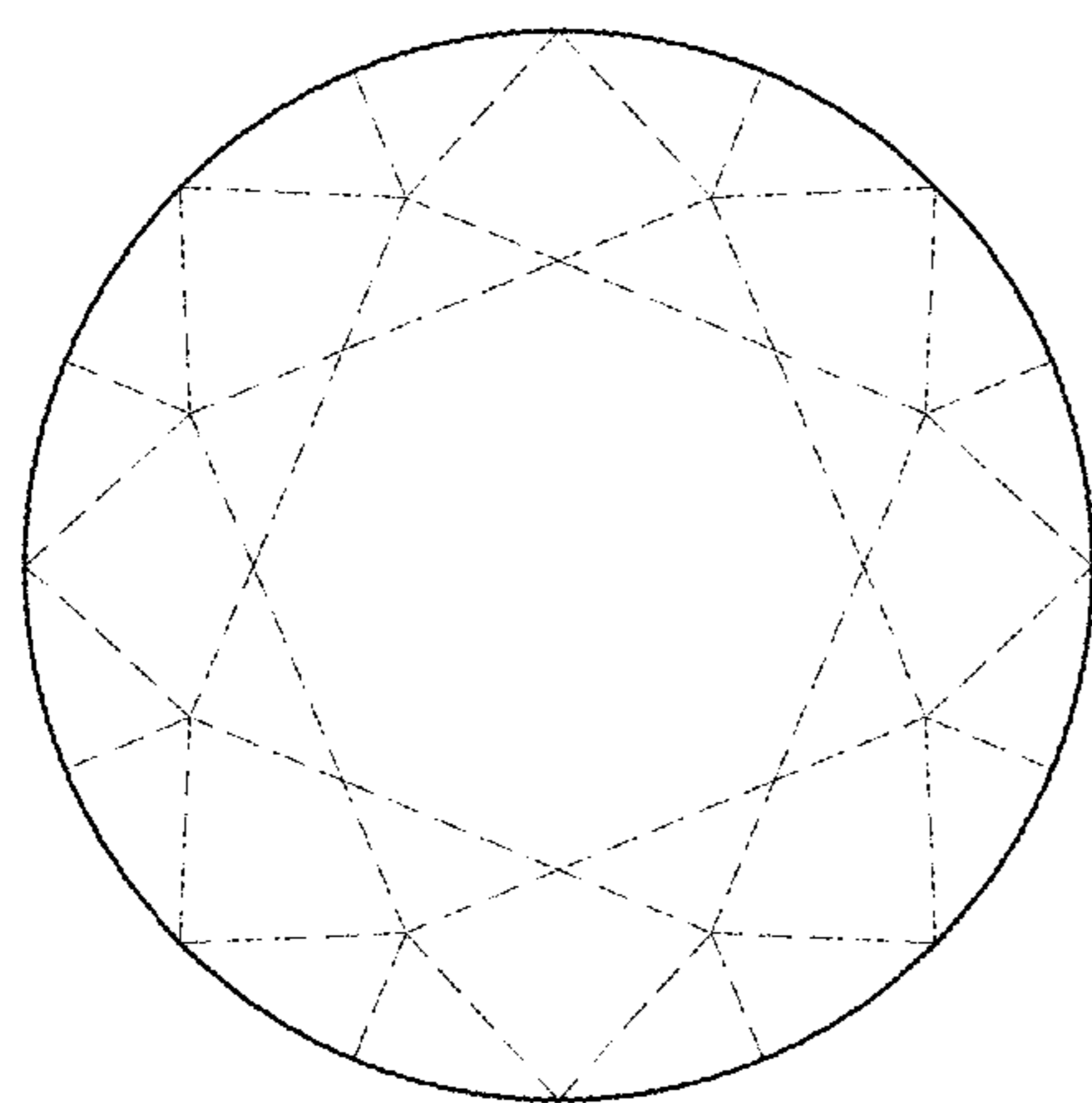

FIG. 9

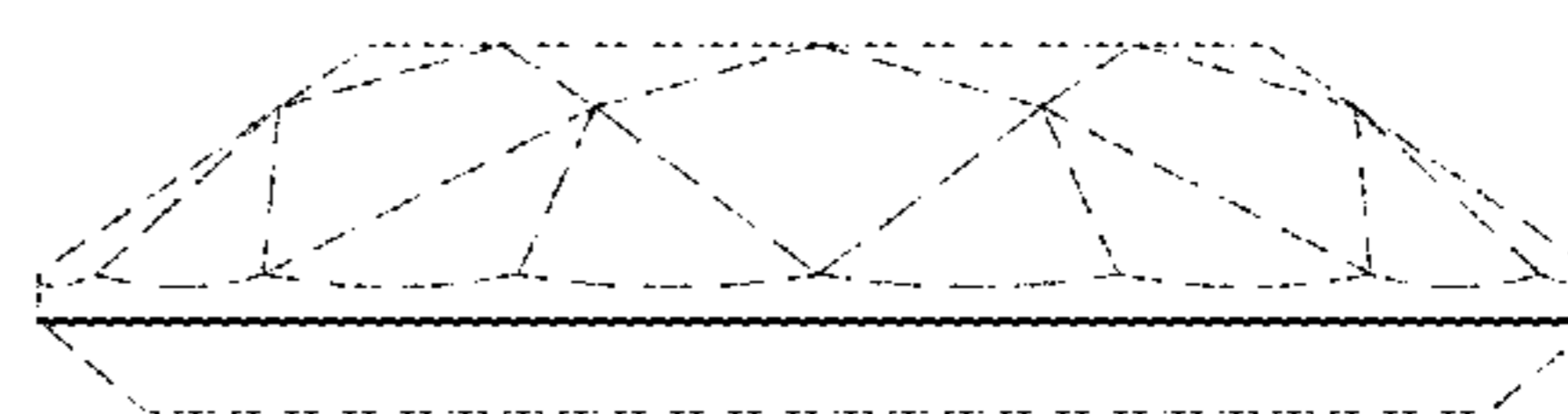

FIG. 10