

US00D770235S

(12) **United States Design Patent** (10) **Patent No.:** **US D770,235 S**  
**Wassenius et al.** (45) **Date of Patent:** **\*\* Nov. 1, 2016**

(54) **CONTAINER FOR COOLING BEVERAGES OF ANY KIND CONTAINED IN ANY KIND OF CONTAINER**

(71) Applicant: **Red Bull GmbH**, Fuschl am See (AT)

(72) Inventors: **Christofer Wassenius**, Fuschl am See (AT); **Matthias Rinderer**, Fuschl am See (AT); **Juergen Brenneis**, Fuschl am See (AT); **David Kehoe**, Alexandria (AU); **Daniel Schneider, Jr.**, Fuschl am See (AT)

(73) Assignee: **Red Bull GmbH**, Fuschl am See (AT)

(\*\*) Term: **14 Years**

(21) Appl. No.: **29/516,760**

(22) Filed: **Feb. 5, 2015**

(30) **Foreign Application Priority Data**

Aug. 5, 2014 (EM) ..... 002514976-0003

(51) **LOC (10) Cl.** ..... **07-01**

(52) **U.S. Cl.**  
USPC ..... **D7/605**

(58) **Field of Classification Search**  
USPC ..... D7/605, 606, 628; D9/738, 744, 763, D9/766, 767; D23/381, 336  
CPC ..... A47F 3/04; B62B 3/00; B65D 6/00; B65D 81/38; B65D 17/165; B65D 81/3886; F25D 3/00; F25D 3/06; F25D 3/08; F25D 2331/803; F25D 2331/804; F25D 2331/805; F25D 2331/806; F25D 2331/807; F25D 2331/808; F25D 2331/809

See application file for complete search history.

(56) **References Cited**

**U.S. PATENT DOCUMENTS**

D329,151 S \* 9/1992 Baer ..... D34/39  
5,251,460 A \* 10/1993 DeMarco ..... B65D 81/3886  
220/592.19

D349,218 S \* 8/1994 Evans ..... D7/606  
5,433,085 A \* 7/1995 Rogers ..... F25D 3/06  
62/372  
5,596,880 A \* 1/1997 Welker ..... F25D 3/06  
40/606.03  
D434,610 S \* 12/2000 Mount ..... D7/608  
D453,893 S \* 2/2002 Mount ..... D7/608  
D519,788 S \* 5/2006 Ringuet ..... D6/665  
D620,762 S \* 8/2010 Tolle ..... D7/605  
8,297,072 B2 \* 10/2012 Willcoxon ..... F25D 3/08  
62/457.3  
D692,321 S \* 10/2013 Ward ..... D9/744  
2011/0185764 A1 \* 8/2011 Kelly ..... B65D 17/165  
62/457.2  
2013/0048648 A1 \* 2/2013 Robertson ..... F25D 3/06  
220/592.02  
2014/0110912 A1 \* 4/2014 Primiano ..... B65D 81/3806  
280/79.2

\* cited by examiner

*Primary Examiner* — Freda S Nunn

(74) *Attorney, Agent, or Firm* — Collard & Roe, P.C.

(57) **CLAIM**

The ornamental design for a container for cooling beverages of any kind contained in any kind of container, as shown and described.

**DESCRIPTION**

FIG. 1 is a top view of a container for cooling beverages of any kind contained in any kind of container showing our new design;  
FIG. 2 is a front, left side and top perspective view thereof;  
FIG. 3 is a back, right side and top perspective view thereof;  
FIG. 4 is a right side view with the opposite side being a mirror image thereof;  
FIG. 5 is a front view thereof;  
FIG. 6 is a back view thereof; and,  
FIG. 7 is a bottom view thereof.  
The broken lines and areas within the broken lines illustrate portions of the holder that form no part of the claimed design.

**1 Claim, 7 Drawing Sheets**

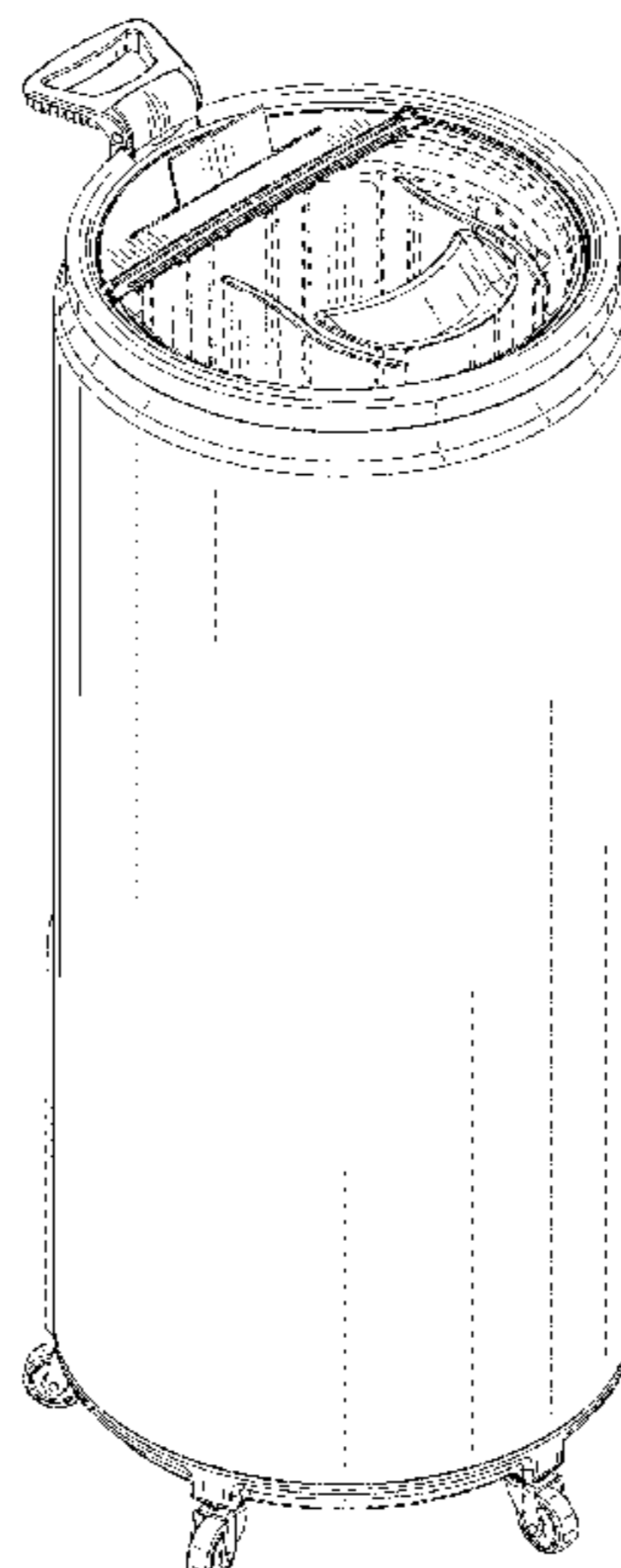

FIG. 1

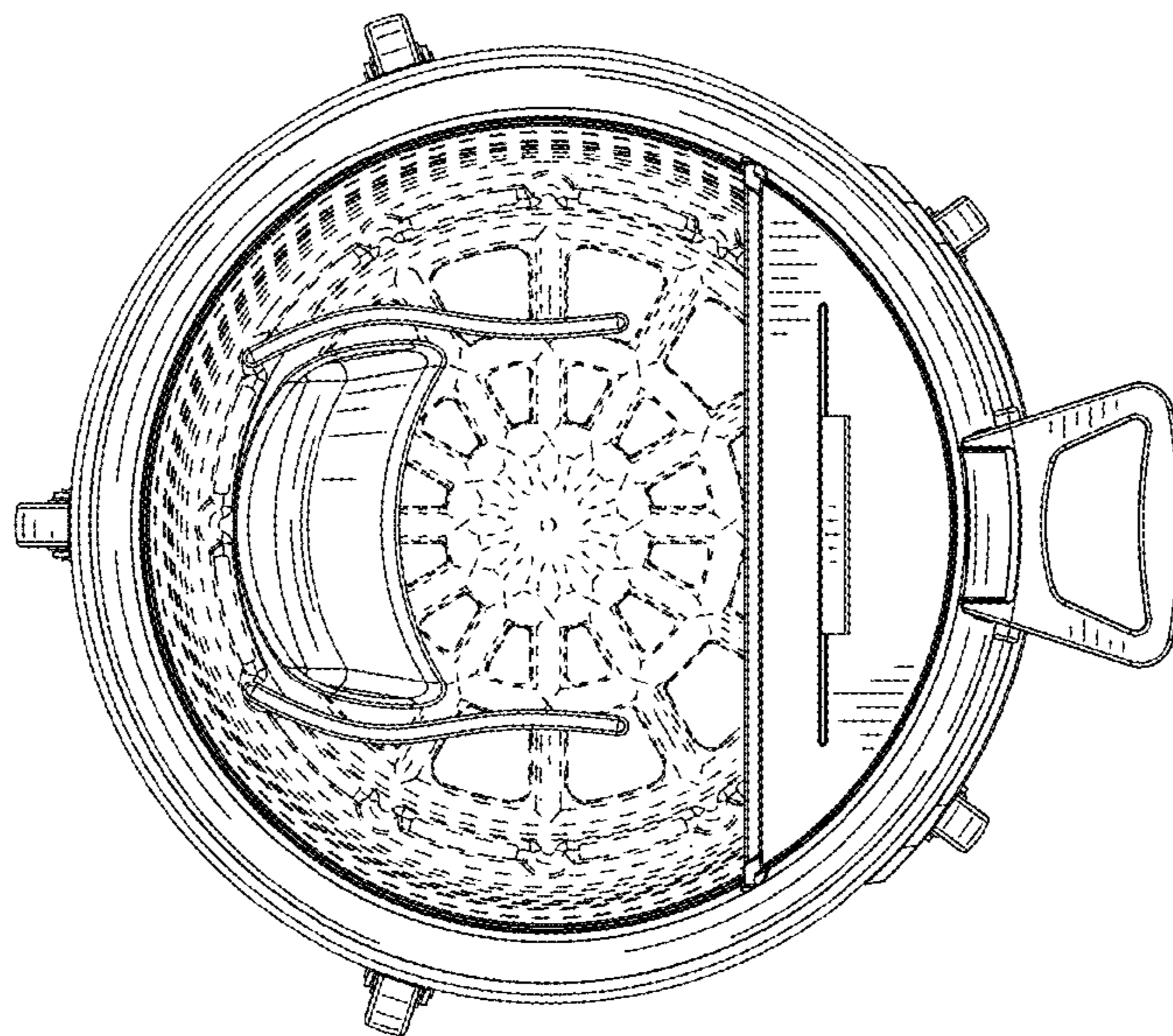

FIG. 2

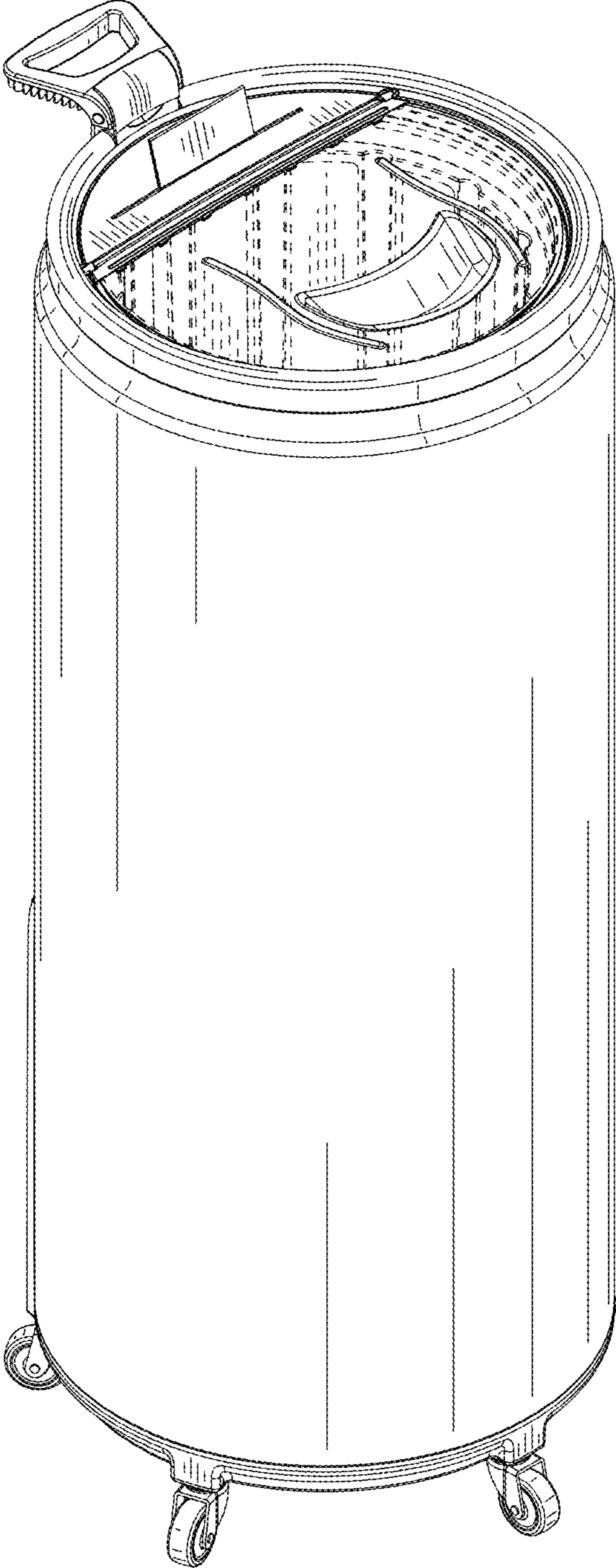

FIG. 3

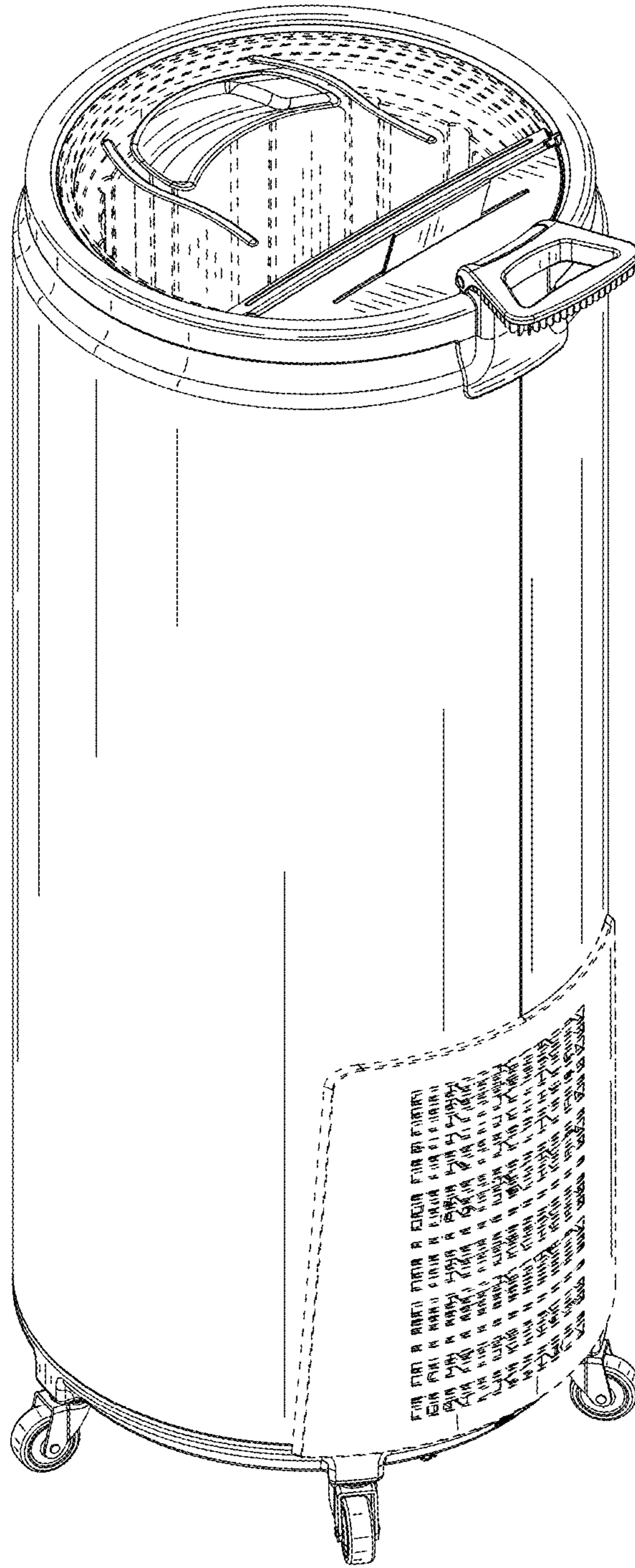

FIG. 4

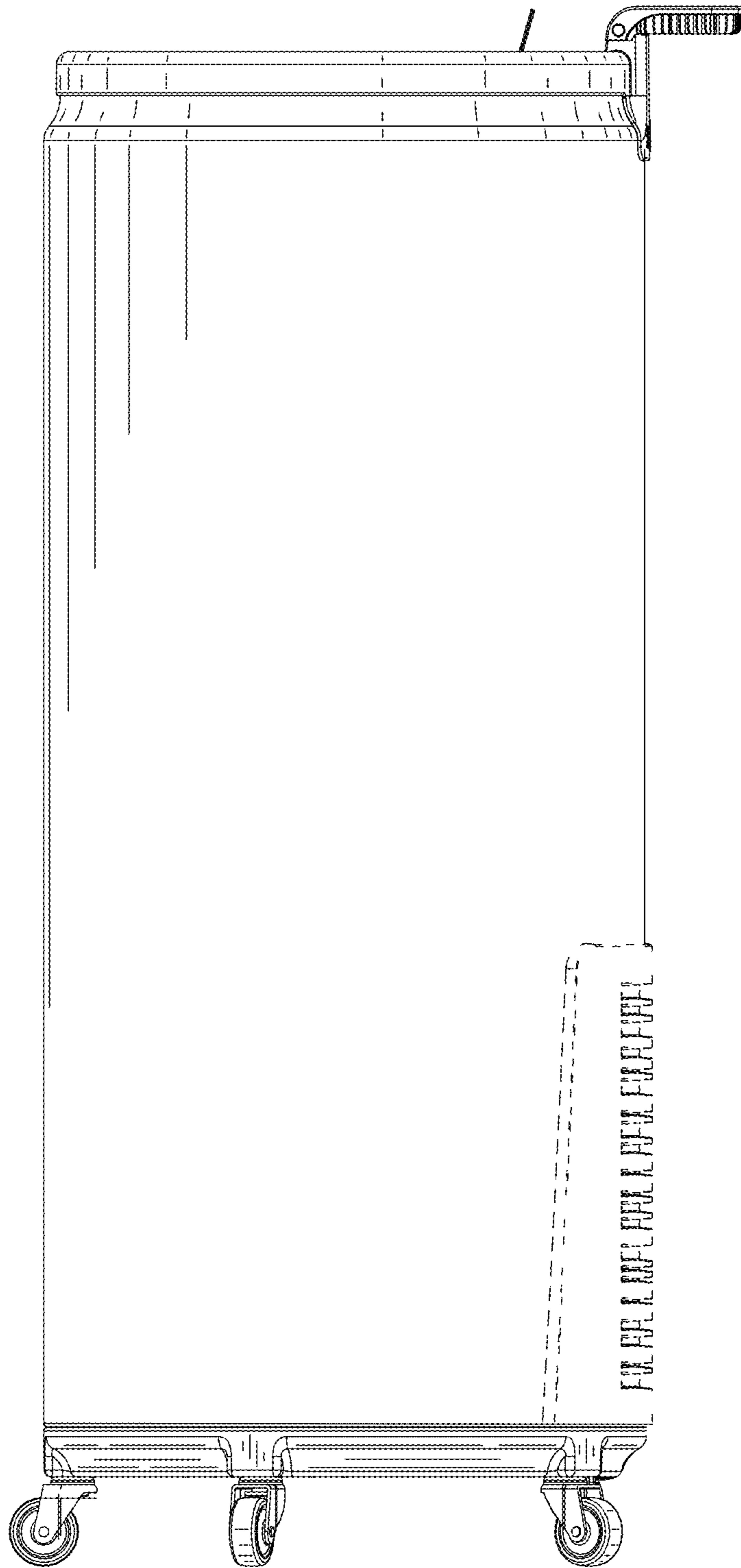

FIG. 5

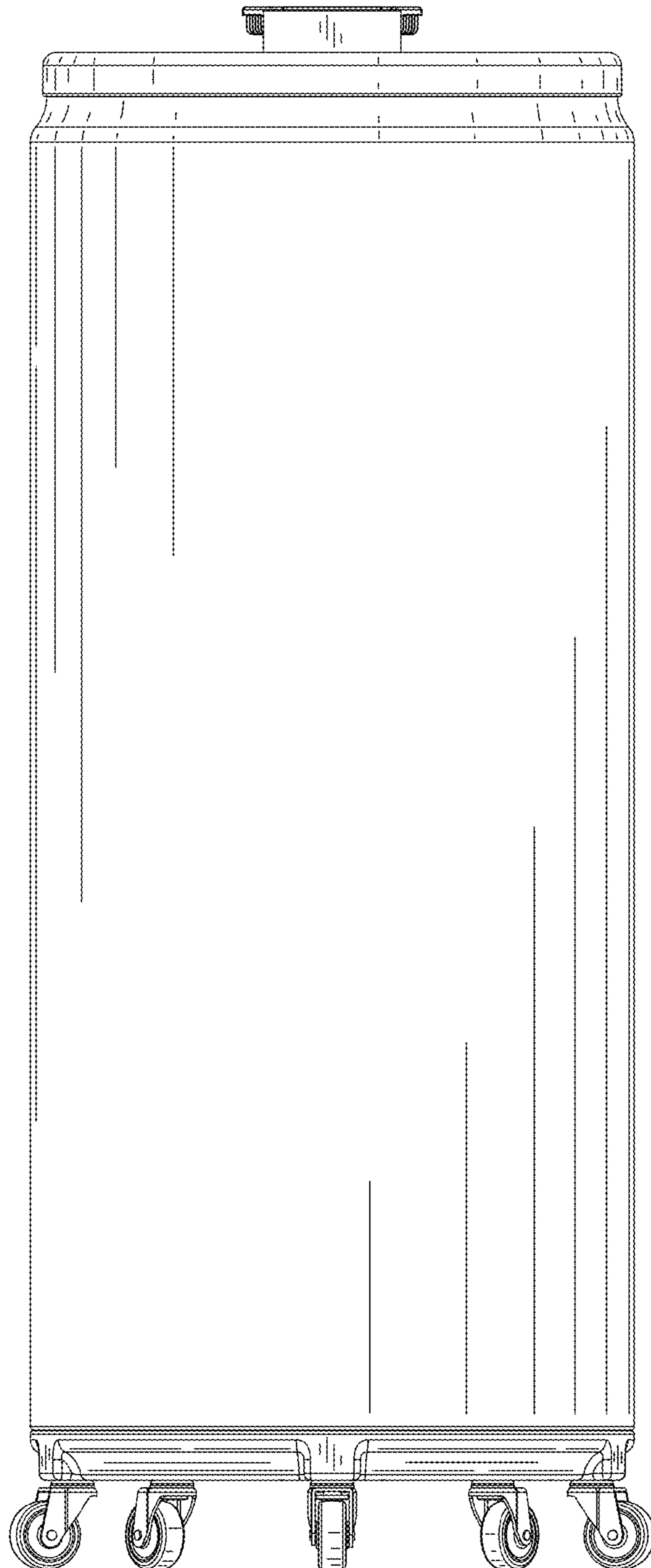

FIG. 6

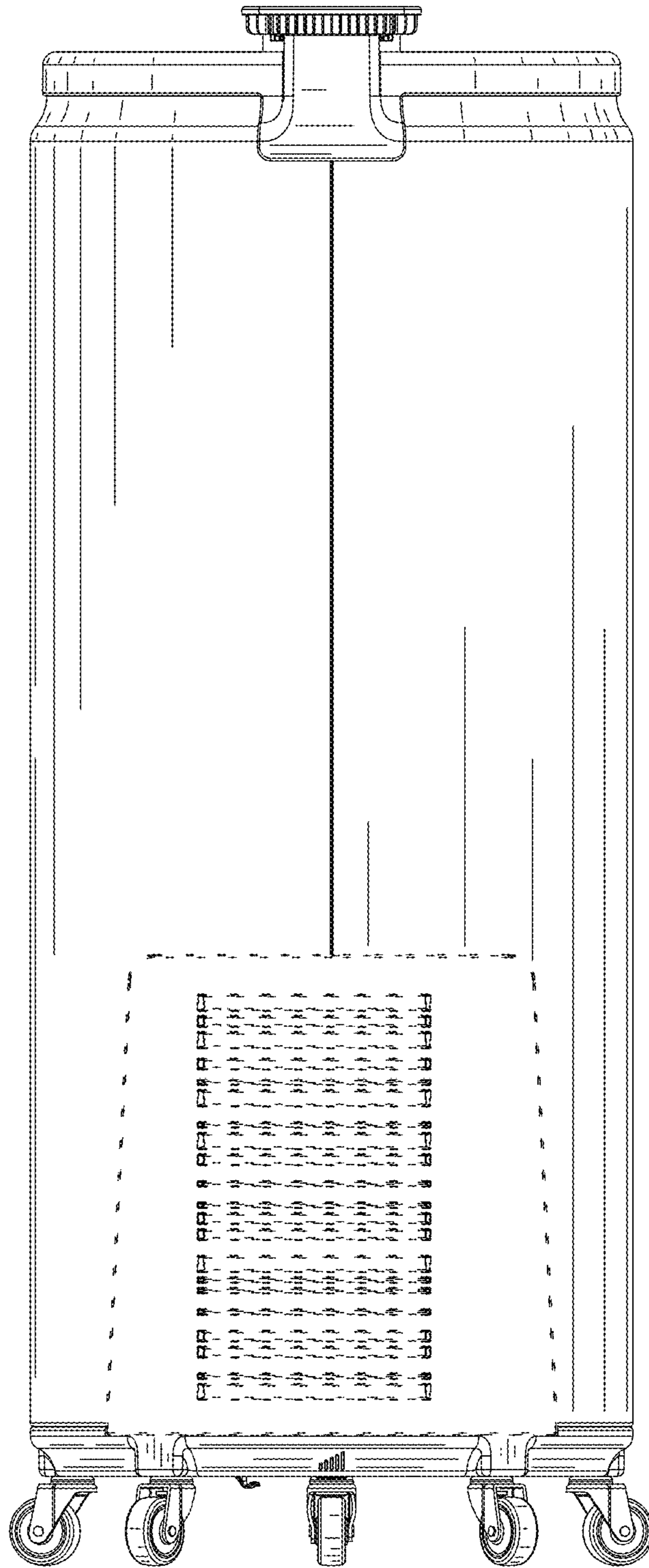

FIG. 7

