



US00D770133S

(12) **United States Design Patent** (10) **Patent No.:** **US D770,133 S**
Burke et al. (45) **Date of Patent:** **** Nov. 1, 2016**

(54) **PANTS**

(71) Applicant: **NIKE, Inc.**, Beaverton, OR (US)

(72) Inventors: **Christine Burke**, Portland, OR (US);
John Burlo, Portland, OR (US)

(73) Assignee: **NIKE, Inc.**, Beaverton, OR (US)

(**) Term: **15 Years**

(21) Appl. No.: **29/540,957**

(22) Filed: **Sep. 29, 2015**

(51) **LOC (10) Cl.** **02-02**

(52) **U.S. Cl.**
USPC **D2/731**

(58) **Field of Classification Search**
USPC D2/731, 712, 742, 739, 738, 853;
2/227, 269, 69
CPC A41D 1/082; A41D 1/08; A41D 13/015;
A41D 1/007; A41D 1/06; A41D 13/0017;
A41D 13/1254; A41F 9/025
See application file for complete search history.

(56) **References Cited**

U.S. PATENT DOCUMENTS

- D35,399 S * 12/1901 Scriven D2/712
- 2,283,362 A * 5/1942 Hamilton A41D 1/082
2/227
- 2,716,754 A * 9/1955 Hirsch A41D 1/08
2/227
- 4,091,466 A * 5/1978 Kearm A41D 13/015
2/227
- D261,324 S 10/1981 Catron
- D280,565 S 9/1985 Winslow
- D300,383 S 3/1989 Yasuda
- 4,893,358 A * 1/1990 Bice, Jr. A41F 9/025
2/221
- D307,505 S * 5/1990 Schiff D2/712
- D317,074 S 5/1991 Beasley
- D350,845 S 9/1994 Mahan
- D381,490 S * 7/1997 Torres D2/742
- D411,907 S * 7/1999 Kling D2/739
- D412,610 S 8/1999 Fujii et al.

- D412,772 S 8/1999 Fujii et al.
- D413,008 S 8/1999 Fujii et al.
- D418,966 S * 1/2000 Walsh D2/712
- D427,750 S 7/2000 Fujii et al.
- D436,713 S * 1/2001 Doolittle D2/742
- D475,836 S * 6/2003 Rohach D2/742
- D483,924 S 12/2003 Morisset

(Continued)

FOREIGN PATENT DOCUMENTS

- EM 001226310-0019 * 7/2010
- EM 002343251-0002 * 11/2013

OTHER PUBLICATIONS

10 Pairs of Sweat—Cool Hunting, Announced Dec. 19, 2013, [Site Visited May 10, 2016] <http://www.coolhunting.com/style/10-pairs-of-sweatpants>.*

(Continued)

Primary Examiner — John Windmuller
Assistant Examiner — Luqman McNeil
(74) *Attorney, Agent, or Firm* — Banner & Witcoff, Ltd.

(57) **CLAIM**

The ornamental design for pants, as shown and described.

DESCRIPTION

FIG. 1 is a front left perspective view of pants showing our new design in an in-use configuration; FIG. 2 is a front view thereof; FIG. 3 is a rear view thereof; FIG. 4 is a left side view thereof; FIG. 5 is a right side view thereof; FIG. 6 is a top view thereof; and, FIG. 7 is a bottom view thereof. The broken lines immediately adjacent to the shaded area represent unclaimed boundaries of the design. The unshaded regions, demarcated by broken lines, represent unclaimed portions of the pants and form no part of the claimed design.

1 Claim, 6 Drawing Sheets

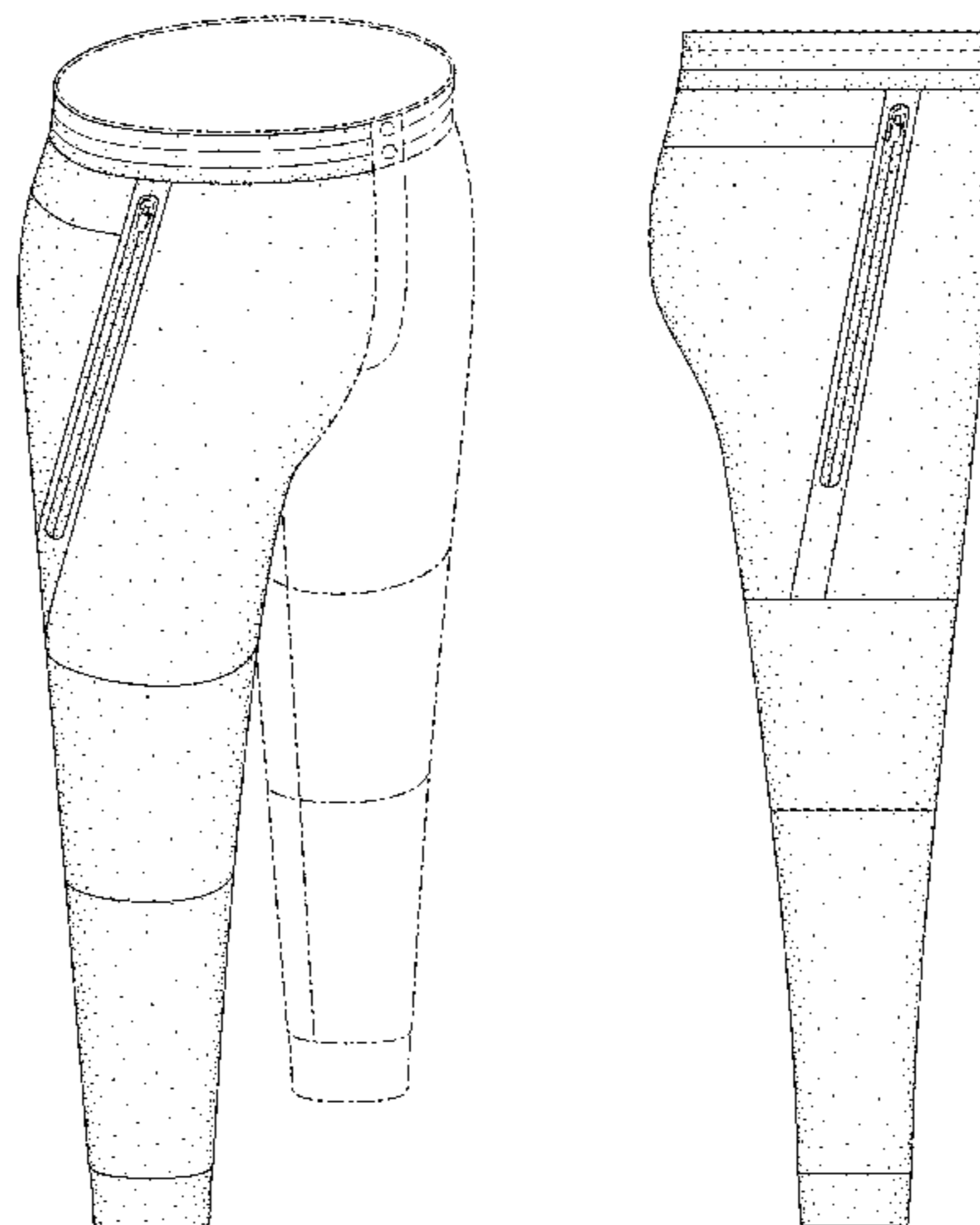

(56)

References Cited

U.S. PATENT DOCUMENTS

D491,712 S 6/2004 Morisset
 D513,660 S 1/2006 Greene
 D518,624 S * 4/2006 Zimmerman D2/742
 D536,157 S * 2/2007 Kimmel D2/742
 D540,509 S * 4/2007 Zimmerman D2/742
 D542,508 S * 5/2007 Zimmerman D2/742
 D566,378 S * 4/2008 St-Germain D2/742
 D575,028 S 8/2008 Patton
 D584,030 S * 1/2009 Ramierez D2/742
 D609,430 S 2/2010 Clement
 D612,580 S 3/2010 Hall et al.
 D612,581 S 3/2010 Ramirez
 D613,038 S 4/2010 Viola et al.
 D614,378 S 4/2010 Viola et al.
 D624,281 S * 9/2010 Richardson, Jr. D2/742
 D630,415 S * 1/2011 Nunn D2/742
 D635,331 S 4/2011 Eckman et al.
 D637,791 S 5/2011 Hall et al.
 D640,041 S 6/2011 Flora et al.
 D641,134 S 7/2011 Zarabi
 D649,746 S 12/2011 Girbaud et al.
 D663,922 S 7/2012 Karik et al.
 D663,923 S 7/2012 Karik et al.
 D664,737 S 8/2012 Slank
 D665,559 S * 8/2012 Ridge D2/742
 8,402,565 B1 * 3/2013 Penner A41D 13/1254
 2/227
 D679,481 S 4/2013 Fuerst
 D679,482 S 4/2013 Fuerst
 D679,483 S 4/2013 Fuerst
 D680,299 S 4/2013 Scott
 D683,522 S * 6/2013 Pasloski D2/731
 D688,032 S * 8/2013 Harte D2/742
 D690,080 S 9/2013 Grosbol
 D690,081 S 9/2013 Grosbol
 D690,082 S 9/2013 Grosbol
 D690,083 S 9/2013 Grosbol
 D690,084 S 9/2013 Grosbol
 D692,641 S * 11/2013 Lai D2/853
 D693,091 S 11/2013 Peters

D693,989 S * 11/2013 Tanaka D2/742
 D696,487 S * 12/2013 Kurmanow D2/742
 D698,520 S 2/2014 Anderson et al.
 D702,921 S 4/2014 Holmes
 D702,922 S 4/2014 Holmes
 D731,752 S * 6/2015 Roberts D2/742
 D744,196 S * 12/2015 Borovicka D2/738
 D747,592 S * 1/2016 Hammer D2/742
 2001/0004771 A1 * 6/2001 Chou A41D 1/007
 2/227
 2005/0251896 A1 * 11/2005 Donlan A41D 1/06
 2/269
 2009/0178174 A1 * 7/2009 Cash, Jr. A41D 1/08
 2/69
 2011/0314590 A1 * 12/2011 Perron A41D 13/0017
 2/227

OTHER PUBLICATIONS

Tapered Cuff Pants: The Definitive Guide for Women, Announced Jul. 11, 2014, [Site Visited May 10, 2016]<http://thesnobette.com/2014/07/tapered-cuff-pants-the-definitive-guide-for-women/>.
 Sweatpants 2.0: Not Only for Lazy Sundays, Announced May 12, 2014, [Site Visited May 10, 2016]<http://odinganimako.com/2014/05/12/sweatpants-lazy-sundays/>.
 Nike Apparel Catalog, Fall 2010 Performance Apparel, p. 10, published date unknown, but prior to the filing date of the present application, NIKE, Inc., USA.
 Nike Apparel Catalog, Fall 2010 Performance Apparel, p. 60, published date unknown, but prior to the filing date of the present application, NIKE, Inc., USA.
 Nike Apparel Catalog, Holiday 2011 Men's Apparel: Performance, p. 14, published Feb. 2011, NIKE, Inc., USA.
 Nike Apparel Catalog, Spring 2011 Men's Apparel: Classics, p. 12, published date unknown, but prior to the filing date of the present application, NIKE, Inc., USA.
 Nike Apparel Catalog, Summer 2011 Women's Apparel: Performance, p. 10, published date unknown, but prior to the filing date of the present application, NIKE, Inc., USA.

* cited by examiner

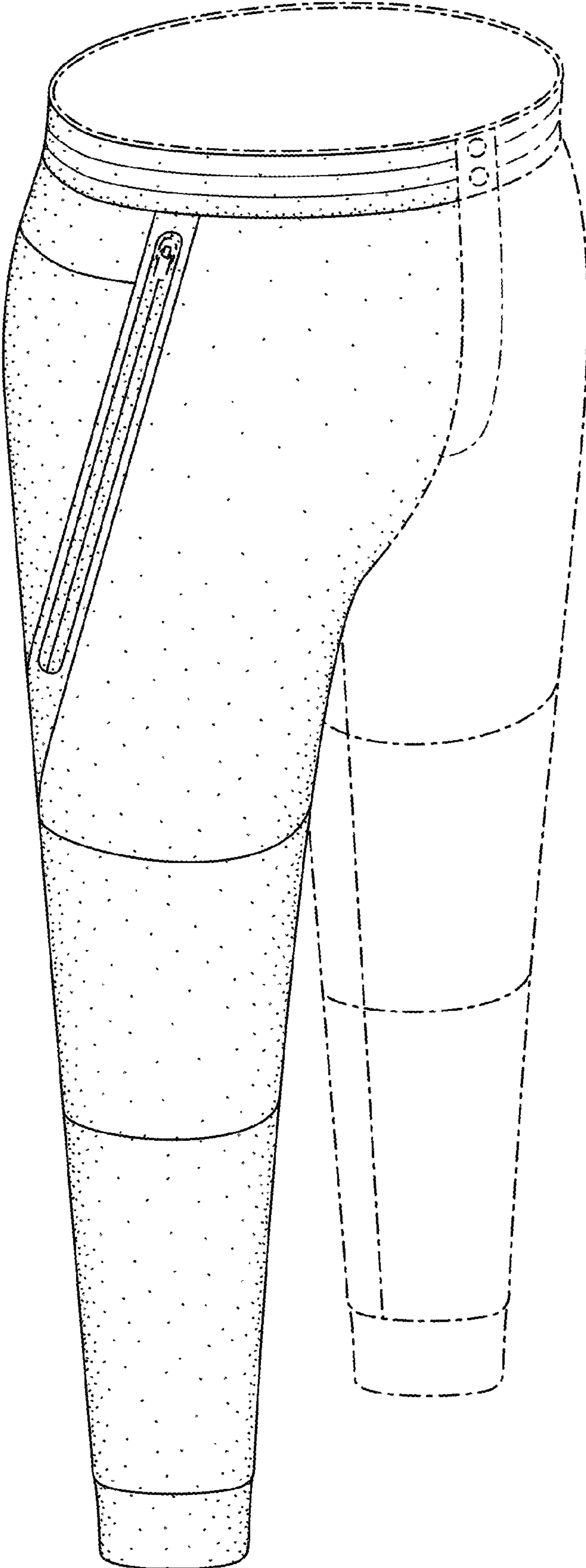

FIG. 1

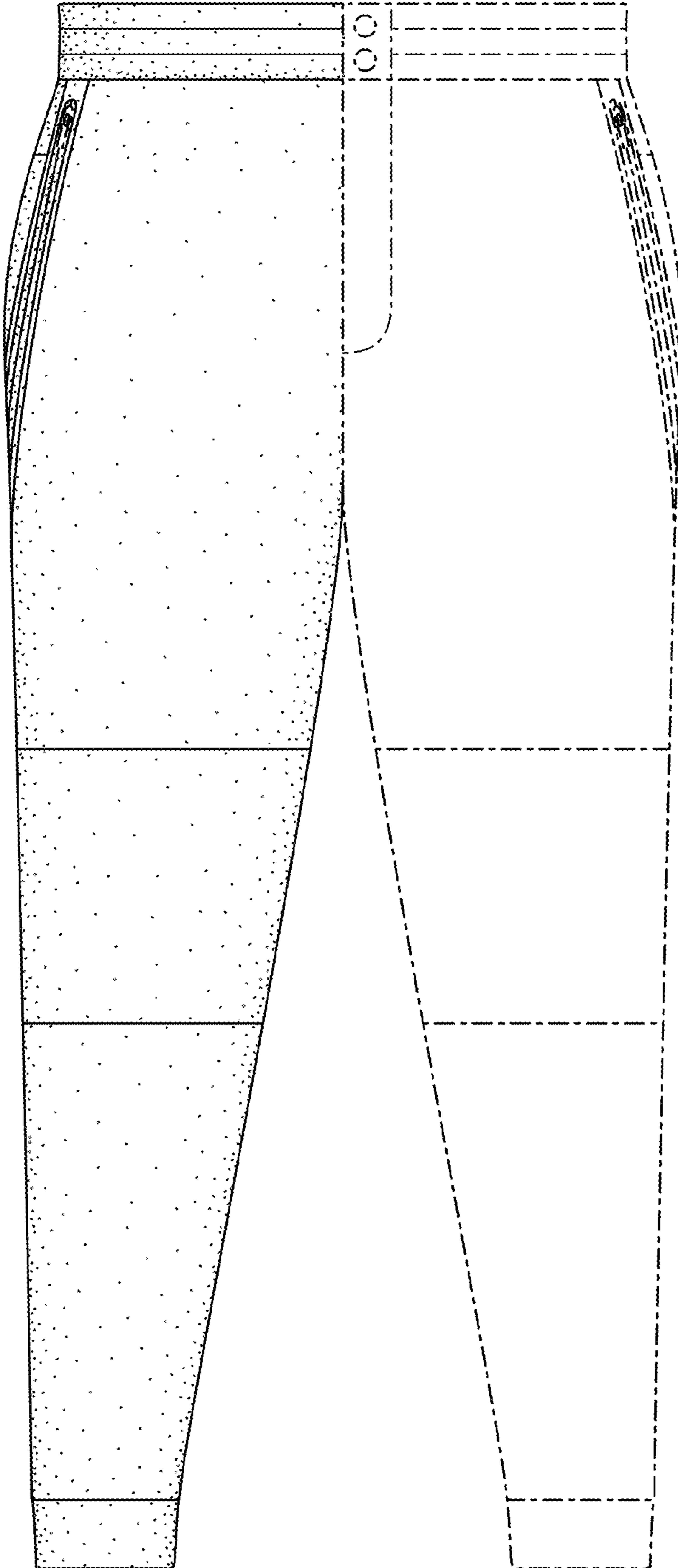

FIG. 2

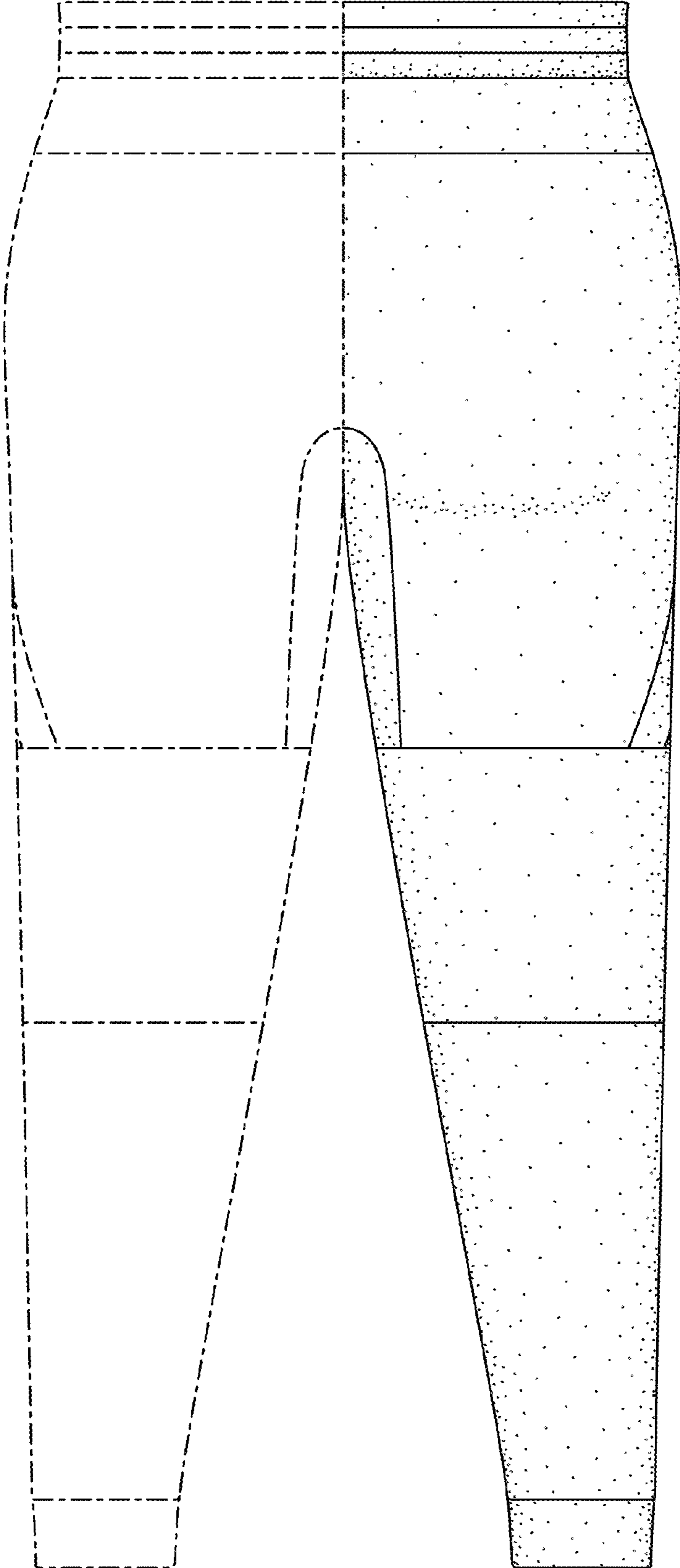

FIG. 3

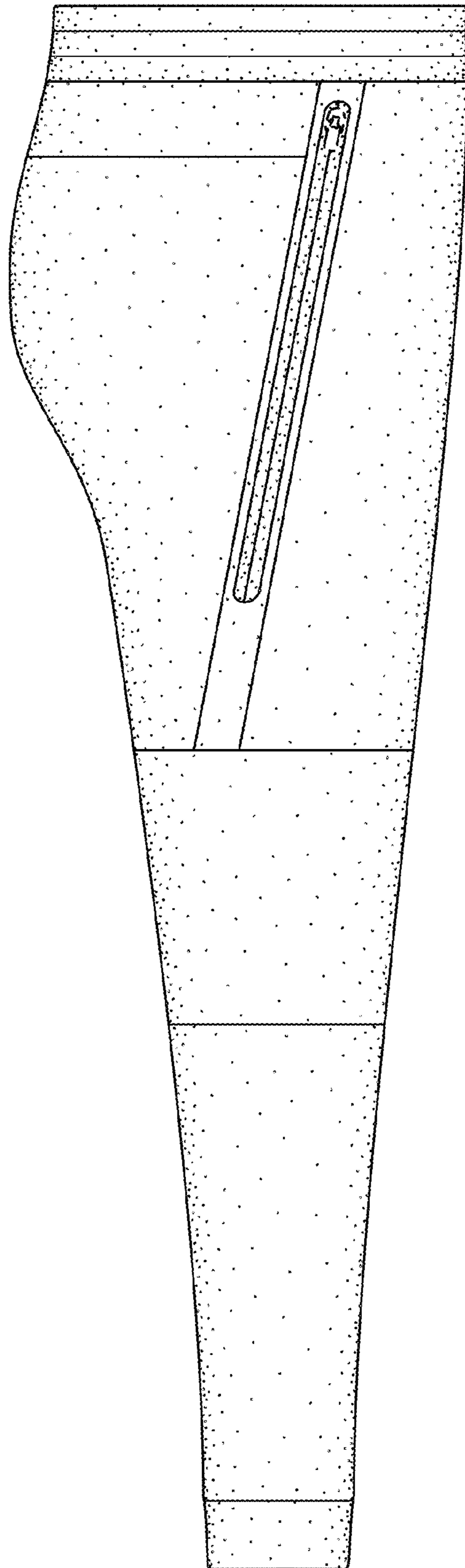

FIG. 4

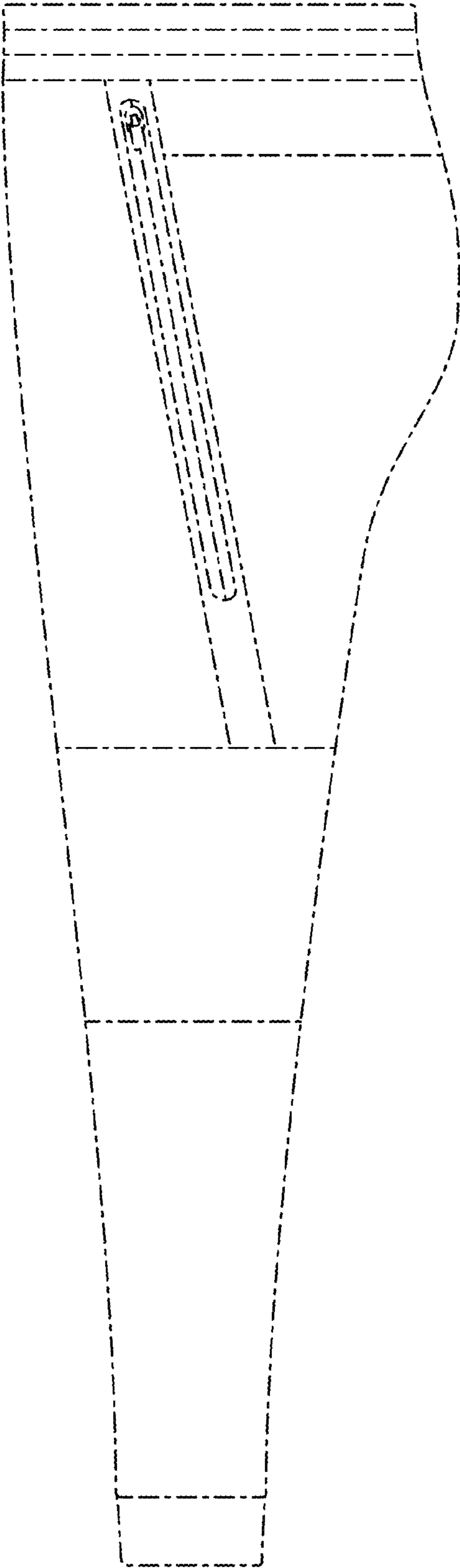

FIG. 5

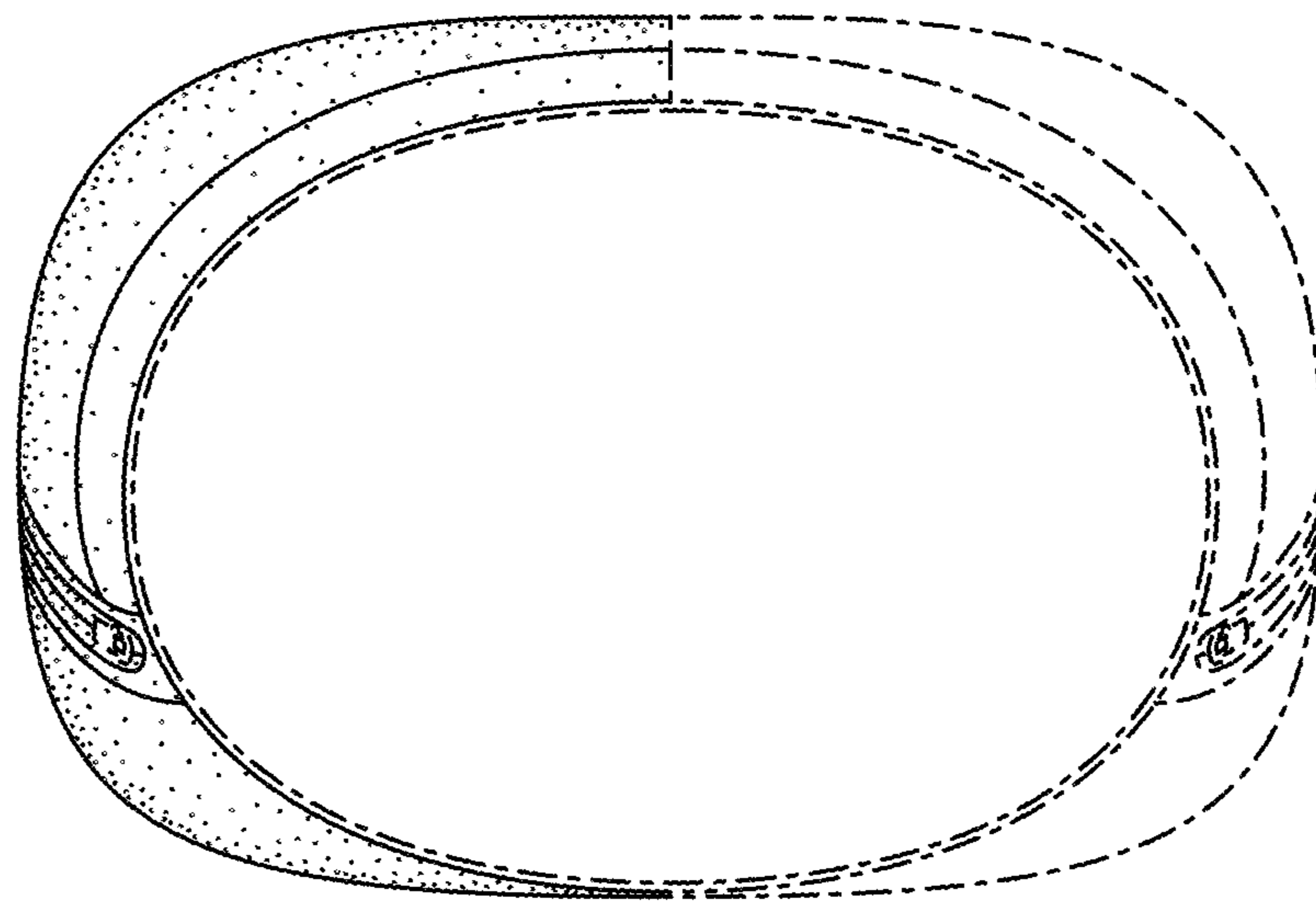

FIG. 6

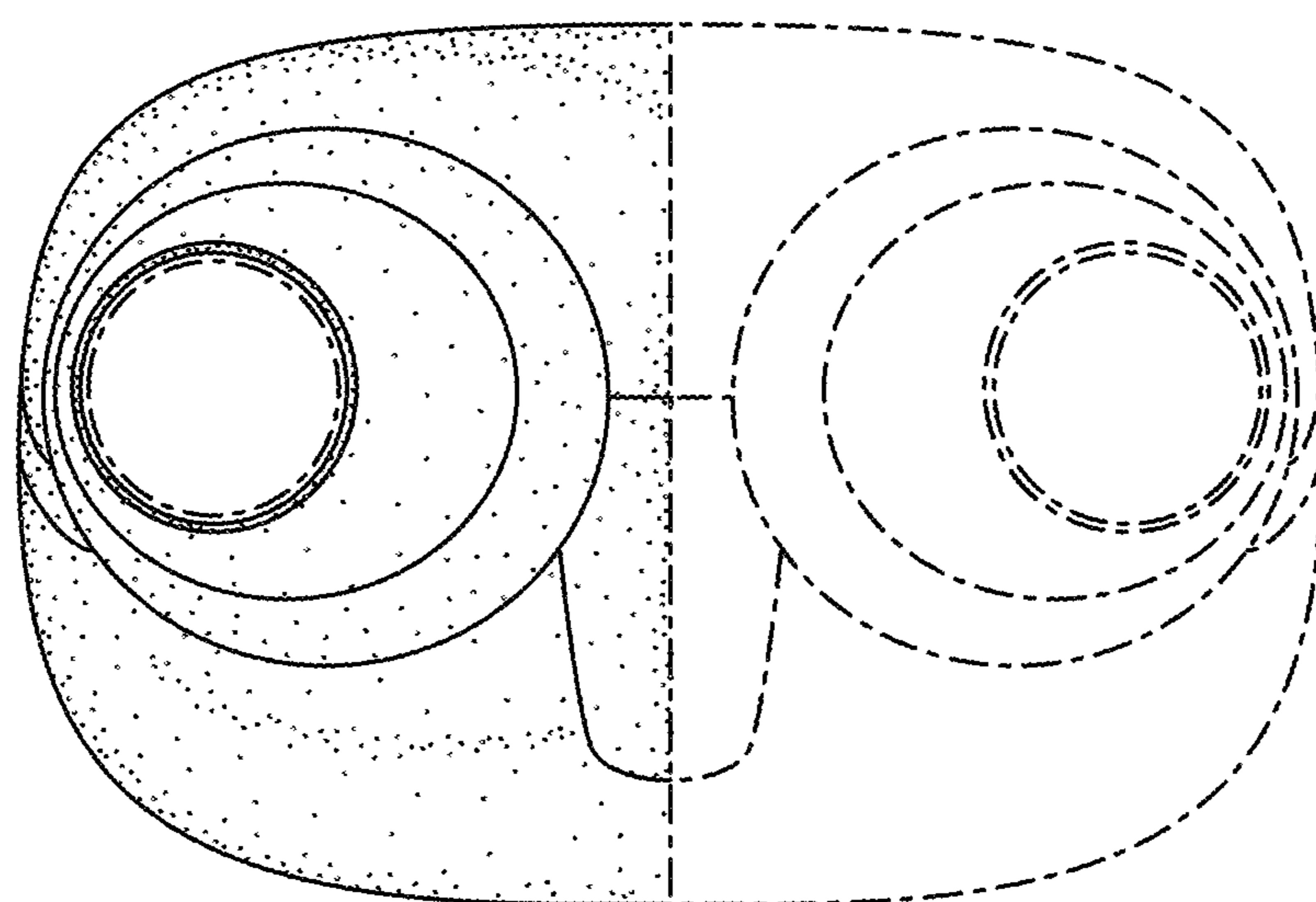

FIG. 7