



US00D770129S

(12) **United States Design Patent** (10) **Patent No.:** **US D770,129 S**  
**Lomax** (45) **Date of Patent:** **\*\* Nov. 1, 2016**

(54) **UPPER BODY GARMENT**

- (71) Applicant: **NIKE, Inc.**, Beaverton, OR (US)
- (72) Inventor: **Jessica Lomax**, London (GB)
- (73) Assignee: **NIKE, Inc.**, Beaverton, OR (US)
- (\*\*) Term: **14 Years**
- (21) Appl. No.: **29/520,473**
- (22) Filed: **Mar. 13, 2015**
- (51) **LOC (10) Cl.** ..... **02-02**
- (52) **U.S. Cl.**  
USPC ..... **D2/731; D2/828**
- (58) **Field of Classification Search**  
USPC ..... D2/717, 731, 749, 750, 753, 755,  
D2/828-831, 833, 834, 836, 839, 840, 841  
See application file for complete search history.

(56) **References Cited**

**U.S. PATENT DOCUMENTS**

D316,923 S	5/1991	Jensen et al.	
D457,709 S	5/2002	Davis	
D463,092 S	9/2002	Perez	
D474,323 S	5/2003	Carter	
D525,412 S	7/2006	O'Mahony	
D564,182 S	3/2008	Wiens	
D608,982 S	2/2010	Wiens	
D619,785 S	7/2010	Jones et al.	
D638,201 S *	5/2011	Gosse	D2/831
D638,202 S *	5/2011	Gosse	D2/831
D643,597 S	8/2011	Gaeir et al.	
D648,924 S	11/2011	Propst	
D662,284 S	6/2012	Lam	
D694,993 S	12/2013	Tanaka et al.	
D700,418 S	3/2014	Borovicka et al.	
D701,368 S	3/2014	Borovicka et al.	
D704,924 S *	5/2014	Roberts	D2/831
D713,621 S *	9/2014	Pezzimenti	D2/828
D714,525 S *	10/2014	Payne	D2/828
D716,527 S	11/2014	Miyamoto	
D724,292 S	3/2015	Amarasiriwardena et al.	
D733,400 S *	7/2015	Cunningham	D2/720
D742,622 S *	11/2015	Oygarden	D2/830
D744,724 S *	12/2015	Borovicka	D2/828

**OTHER PUBLICATIONS**

Nike Tech Fleece Full Zip Print found online [Jan. 20, 2016]  
[http://store.nike.com/us/en\\_us/pd/tech-fleece-full-zip-print-hoodie/pid-10296842/pgid-10343071](http://store.nike.com/us/en_us/pd/tech-fleece-full-zip-print-hoodie/pid-10296842/pgid-10343071).\*

Nike Apparel Catalog, Holiday 2010 Men's Performance, p. 65, published date unknown, but prior to the filing date of the present application, NIKE, Inc., USA.

Nike Apparel Catalog, Holiday 2010 Women's Apparel: Performance, p. 18, published date unknown, but prior to the filing date of the present application, NIKE, Inc., USA.

Nike Apparel Catalog, Spring 2011 Women's Apparel: Performance, p. 14, published date unknown, but prior to the filing date of the present application, NIKE, Inc., USA.

\* cited by examiner

*Primary Examiner* — Robert M Spear  
*Assistant Examiner* — John Voytek

(74) *Attorney, Agent, or Firm* — Banner & Witcoff, Ltd.

(57) **CLAIM**

The ornamental design for an upper body garment, as shown and described.

**DESCRIPTION**

FIG. 1 is a front left perspective view of an upper body garment showing my new design in an in-use configuration; FIG. 2 is a front right perspective view thereof; FIG. 3 is a front view thereof; FIG. 4 is a rear view thereof; FIG. 5 is a left side view thereof; FIG. 6 is a right side view thereof; FIG. 7 is a top view thereof; FIG. 8 is a bottom view thereof; FIG. 9 is the left side view shown in FIG. 5 with the sleeve removed for clarity to show the features of the claimed design; and, FIG. 10 is the right side view shown in FIG. 6 with the sleeve removed for clarity to show the features of the claimed design.

In the drawings, the hatched pattern represents the appearance of a diamond-shaped open mesh fabric. The unshaded regions, demarcated by broken lines, represent unclaimed portions of the garment and form no part of the claimed design.

**1 Claim, 10 Drawing Sheets**

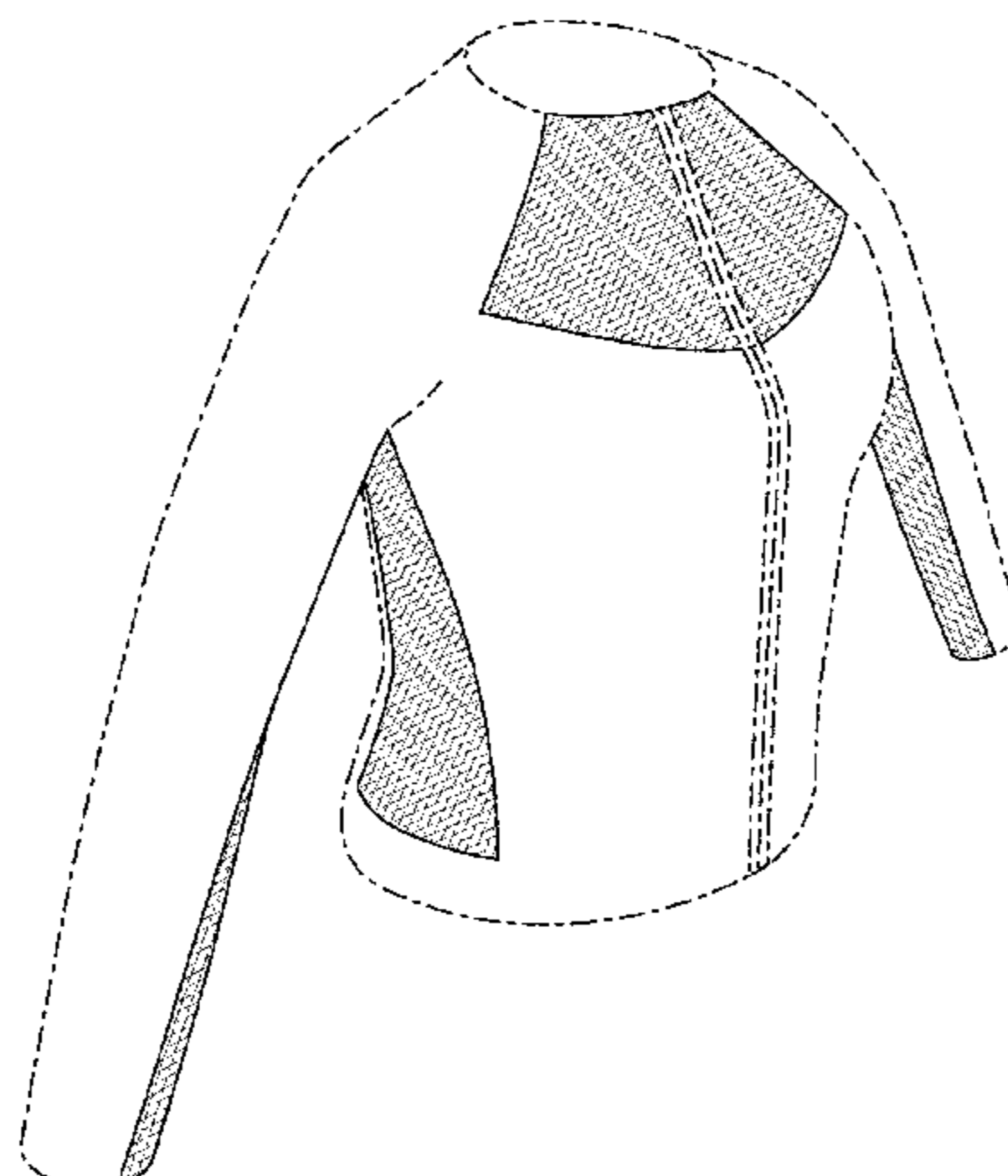

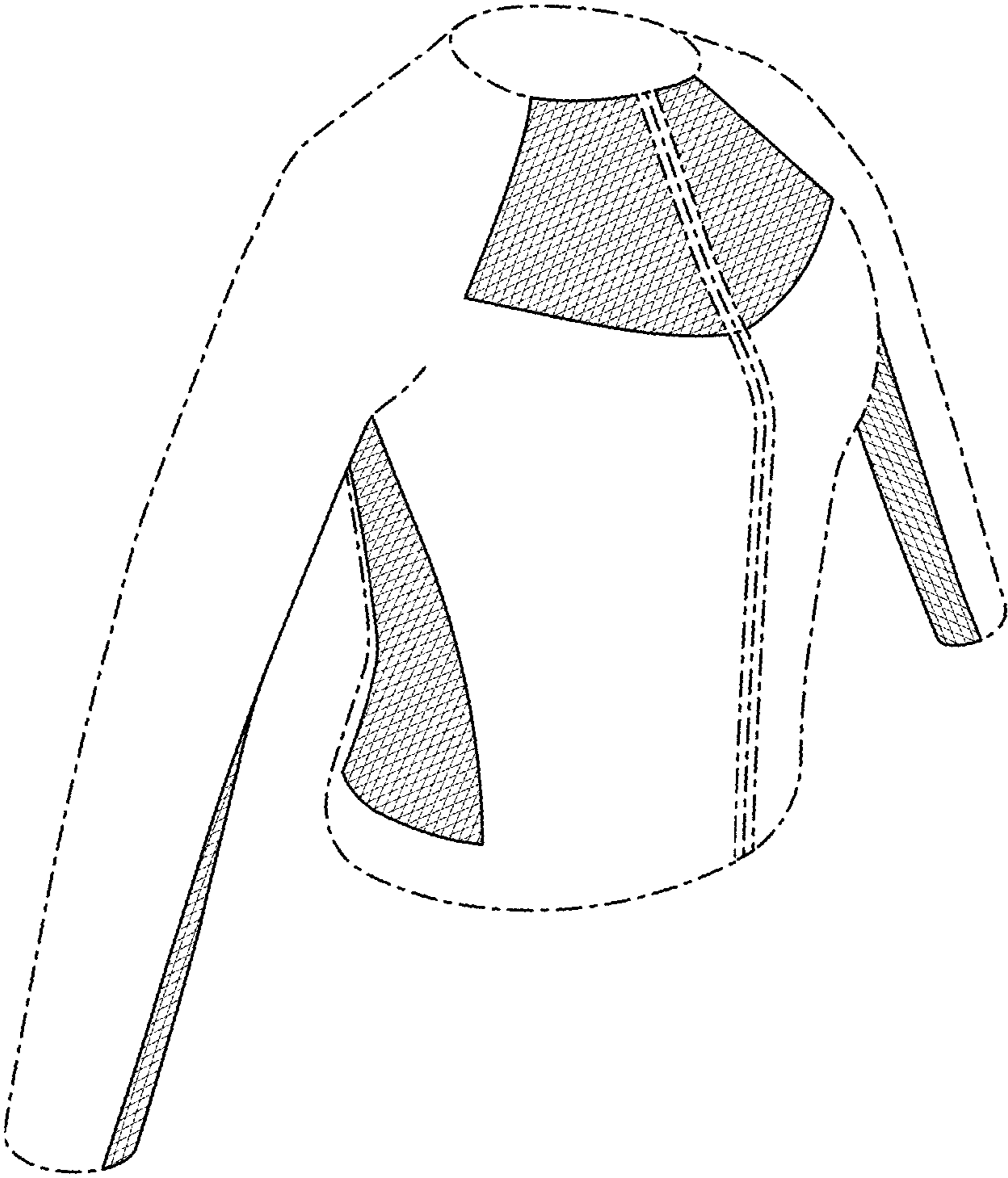

FIG. 1

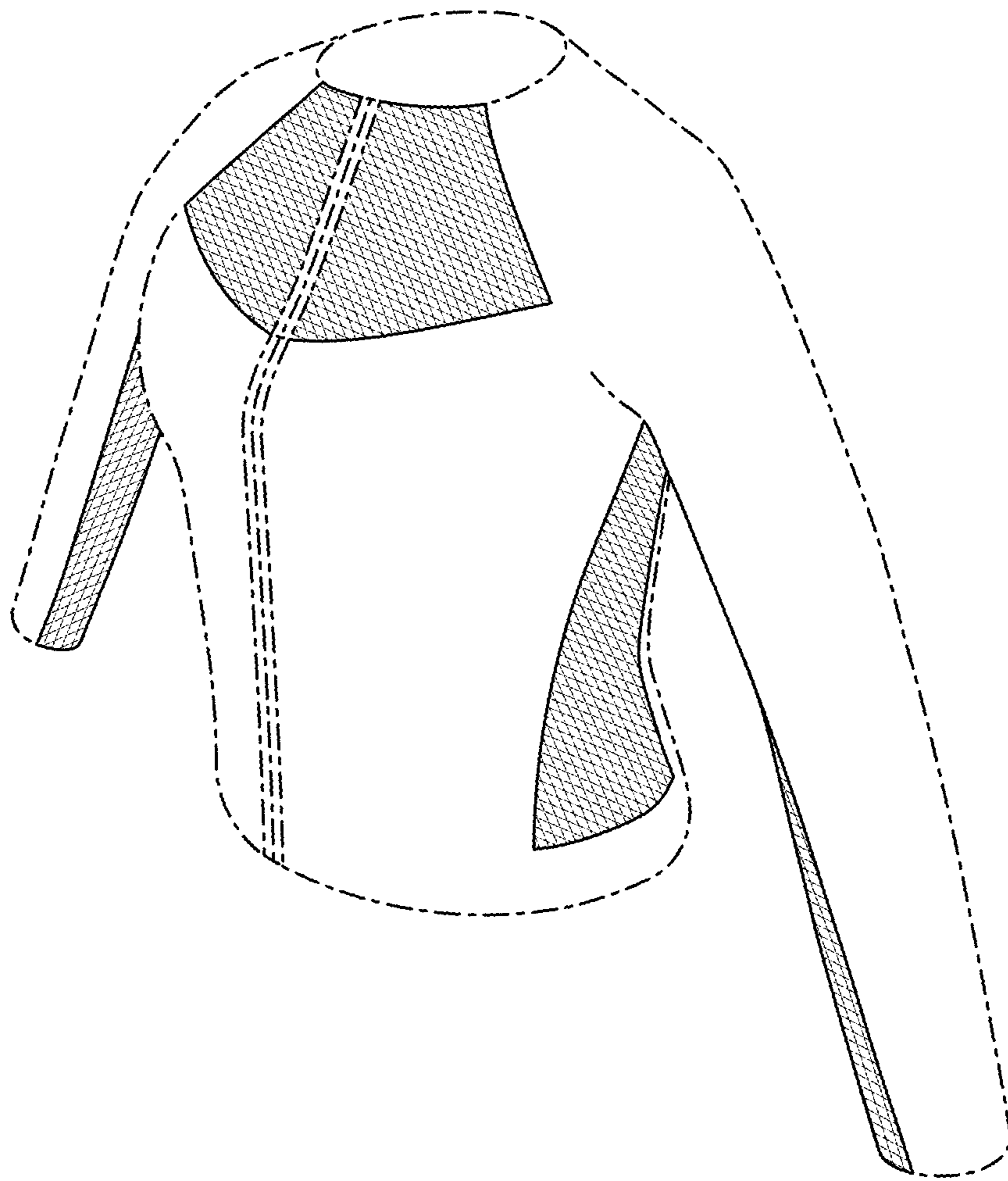

FIG. 2

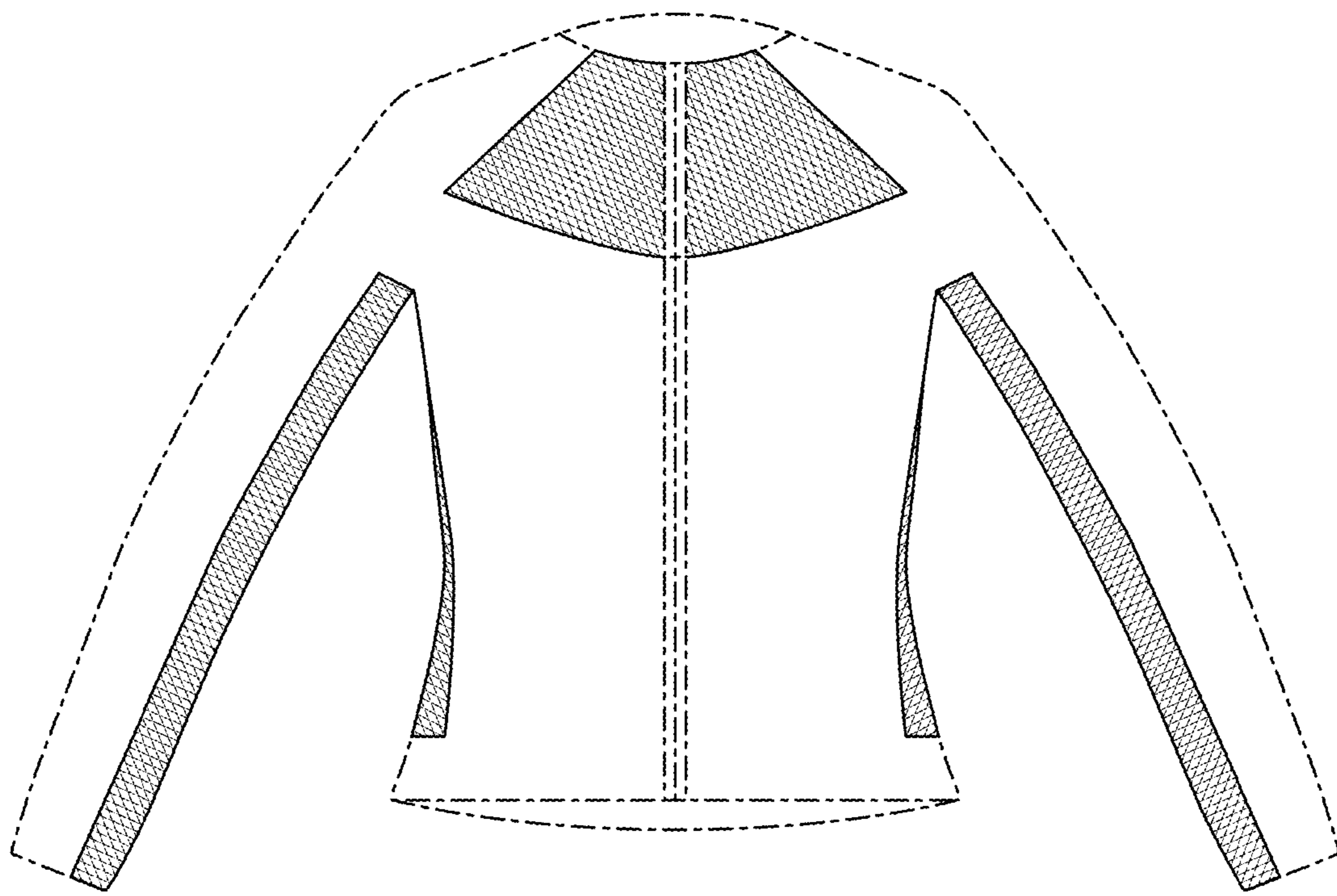

FIG. 3



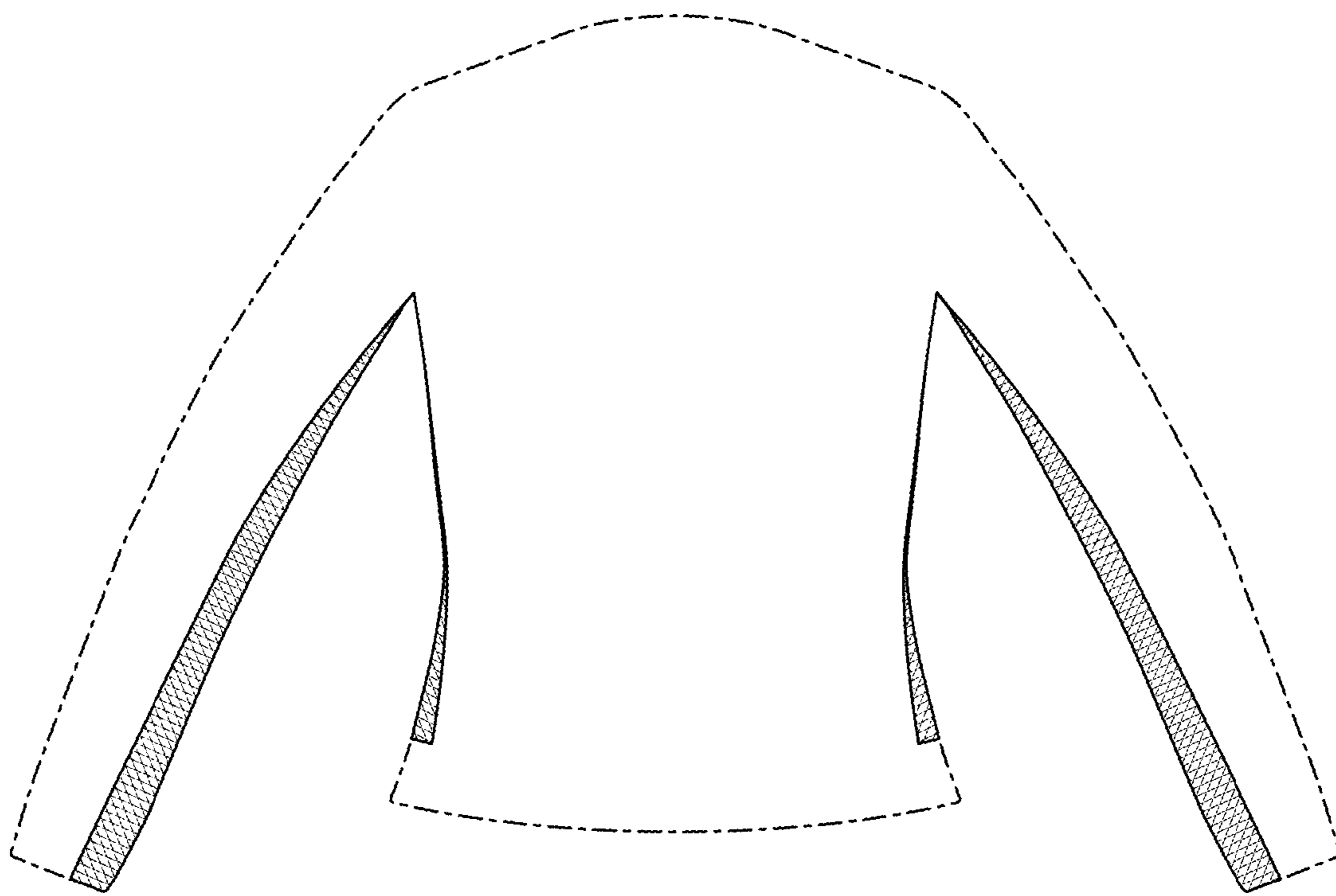

FIG. 4

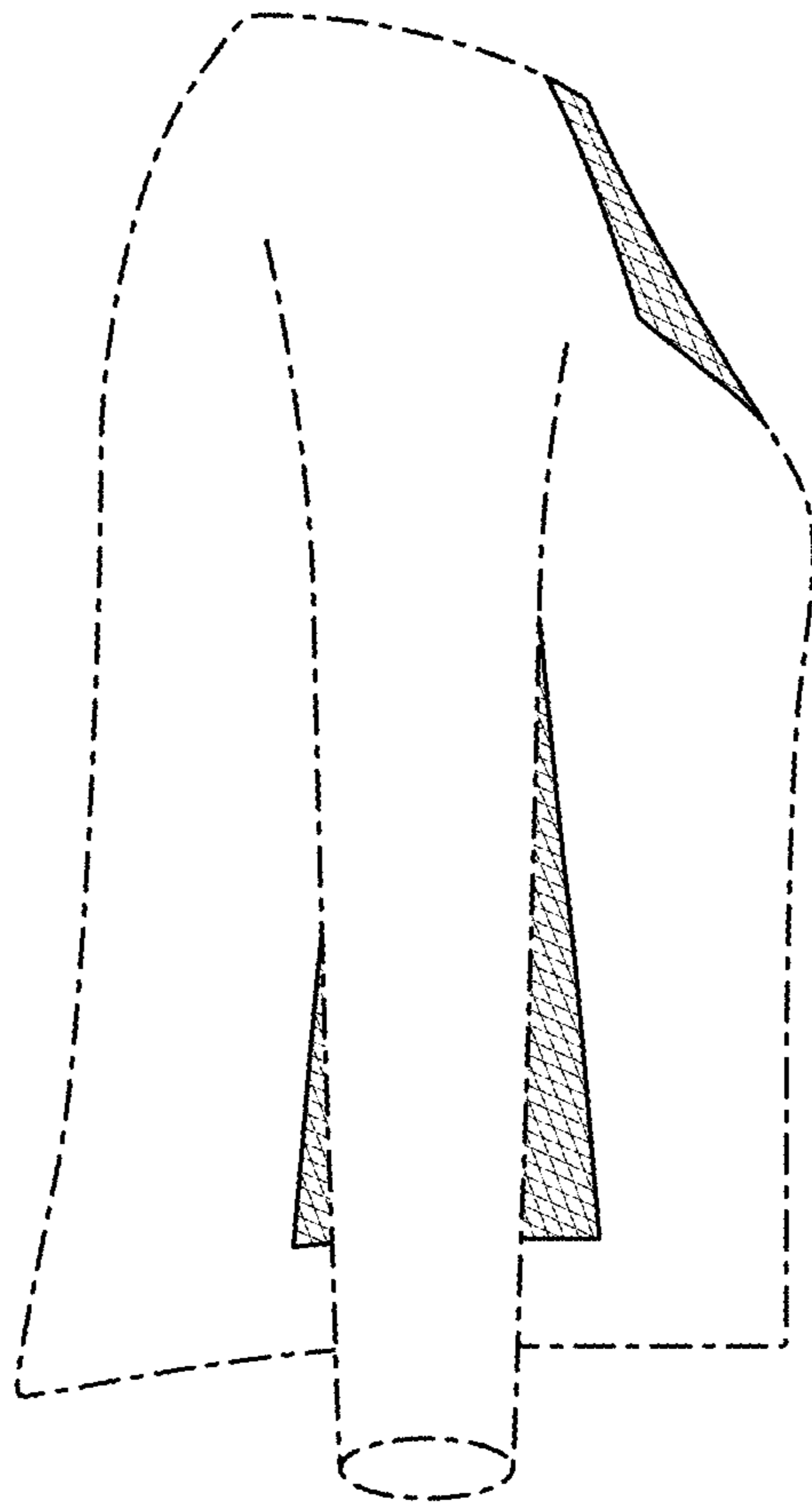

FIG. 5

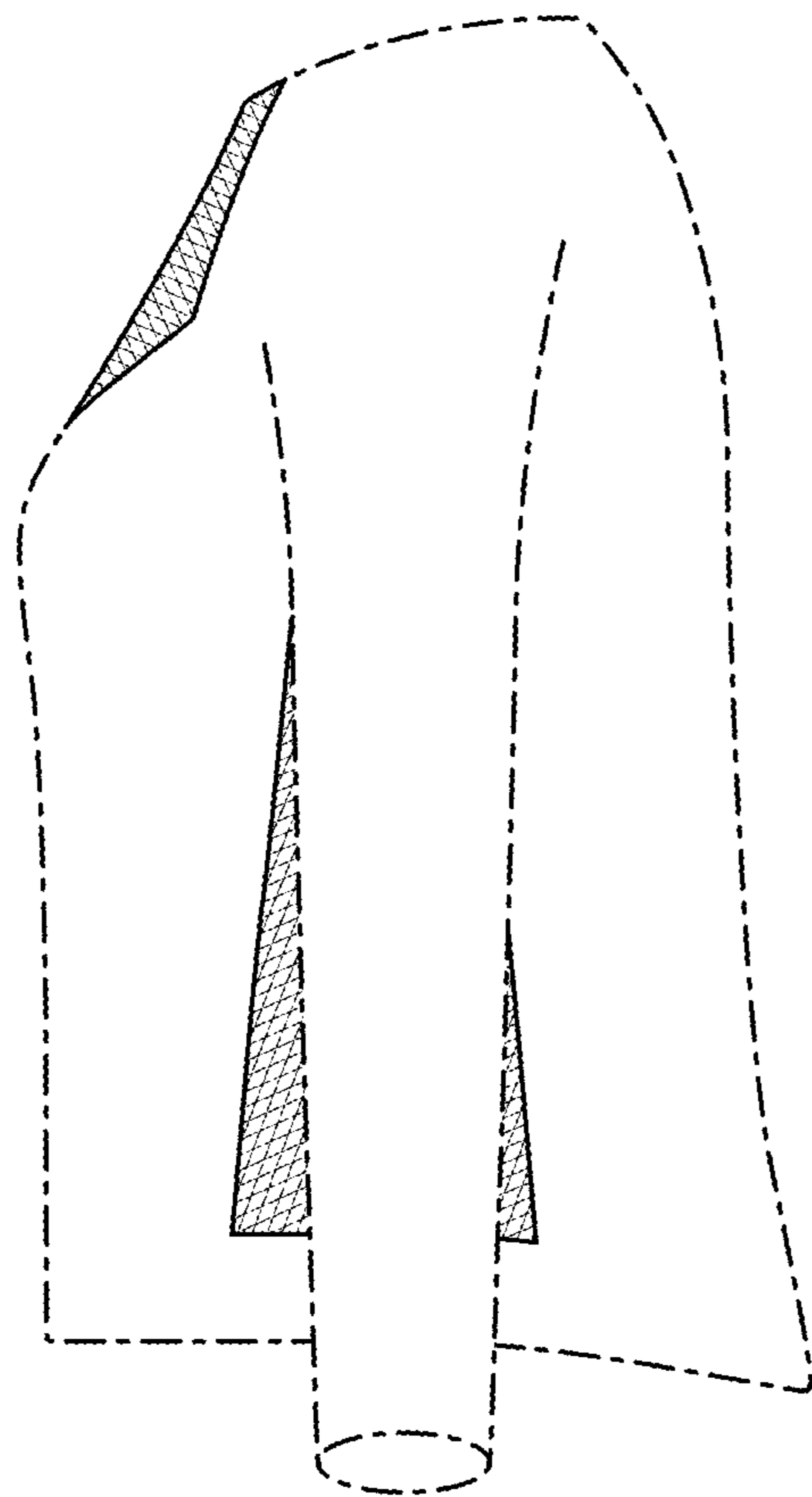

FIG. 6

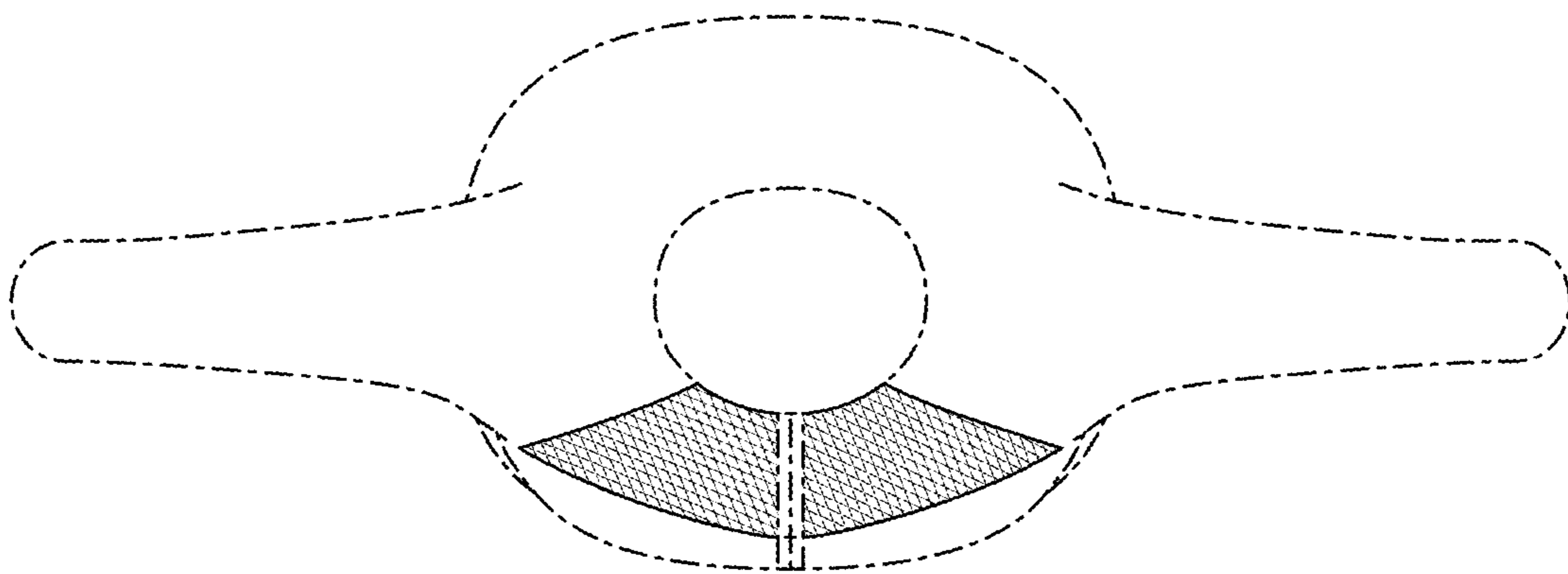

FIG. 7



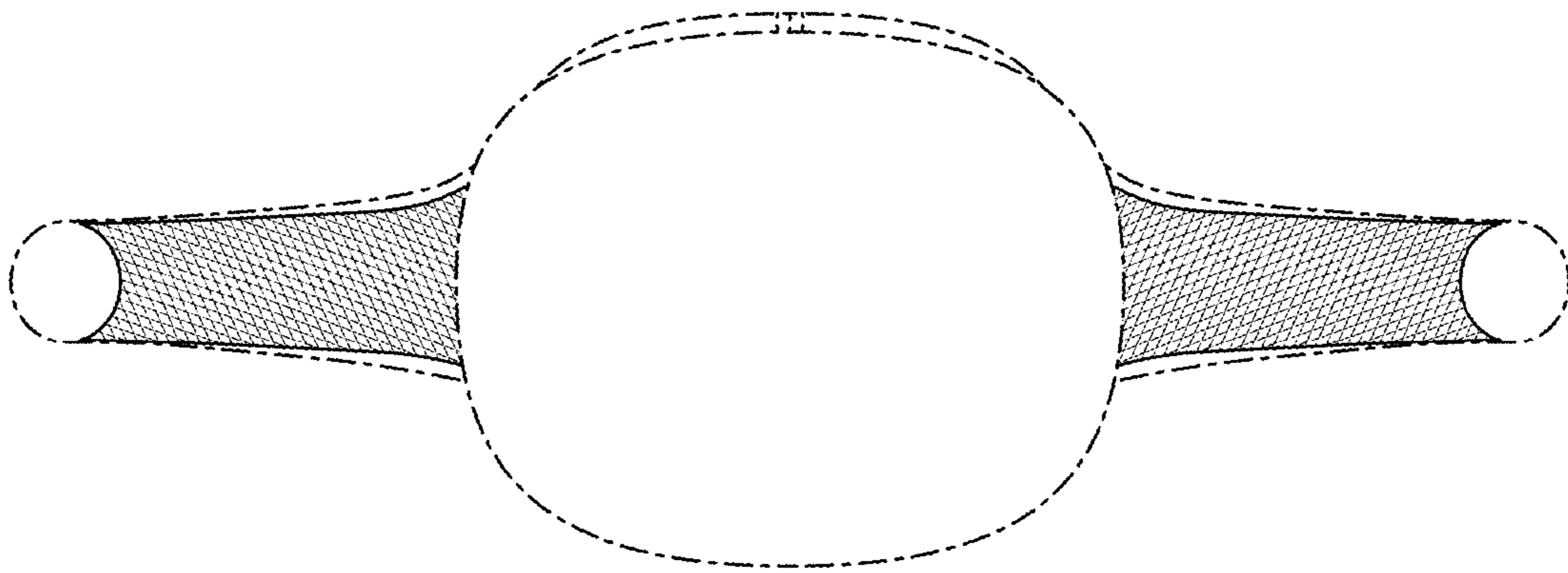

FIG. 8

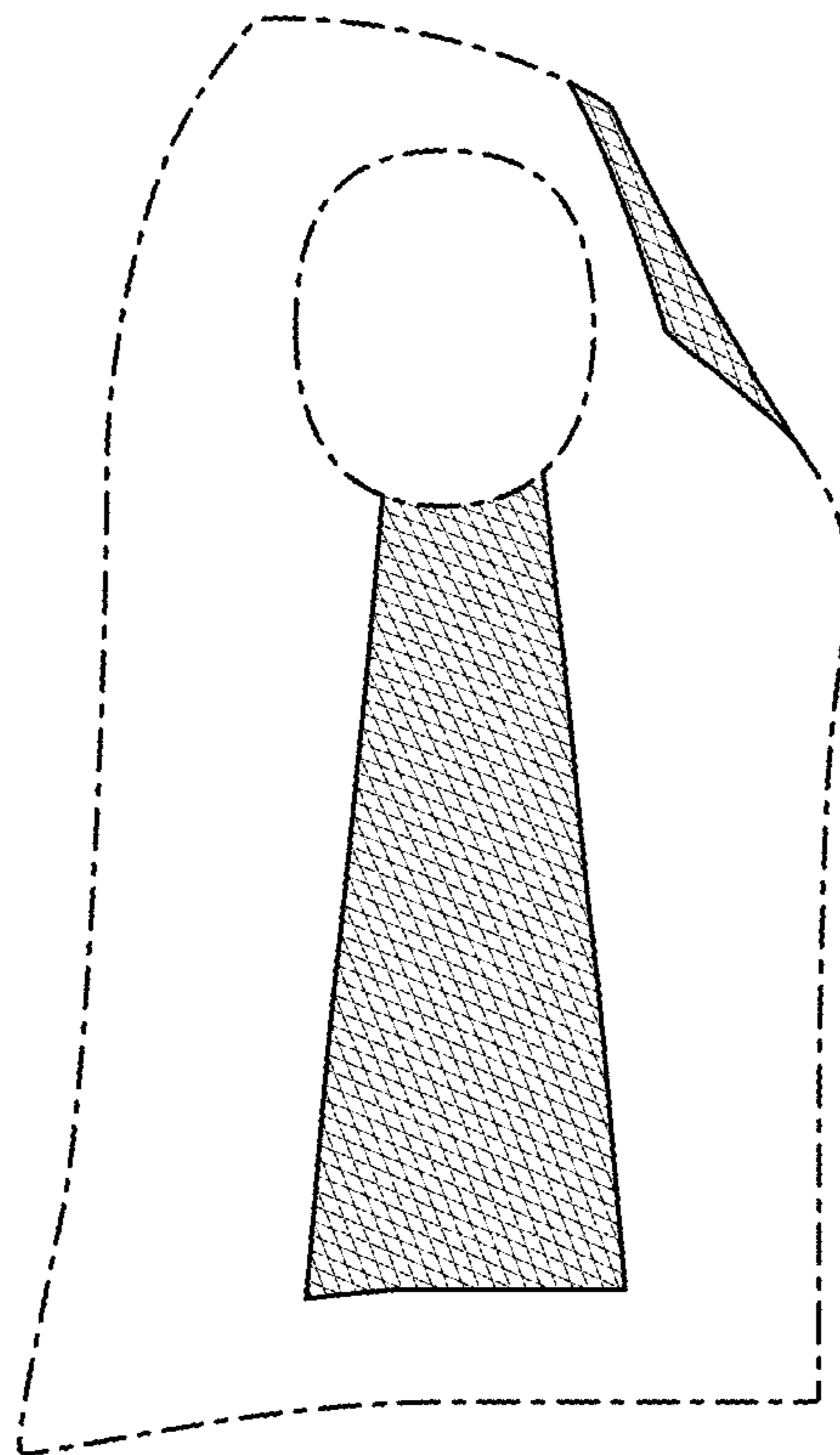

FIG. 9

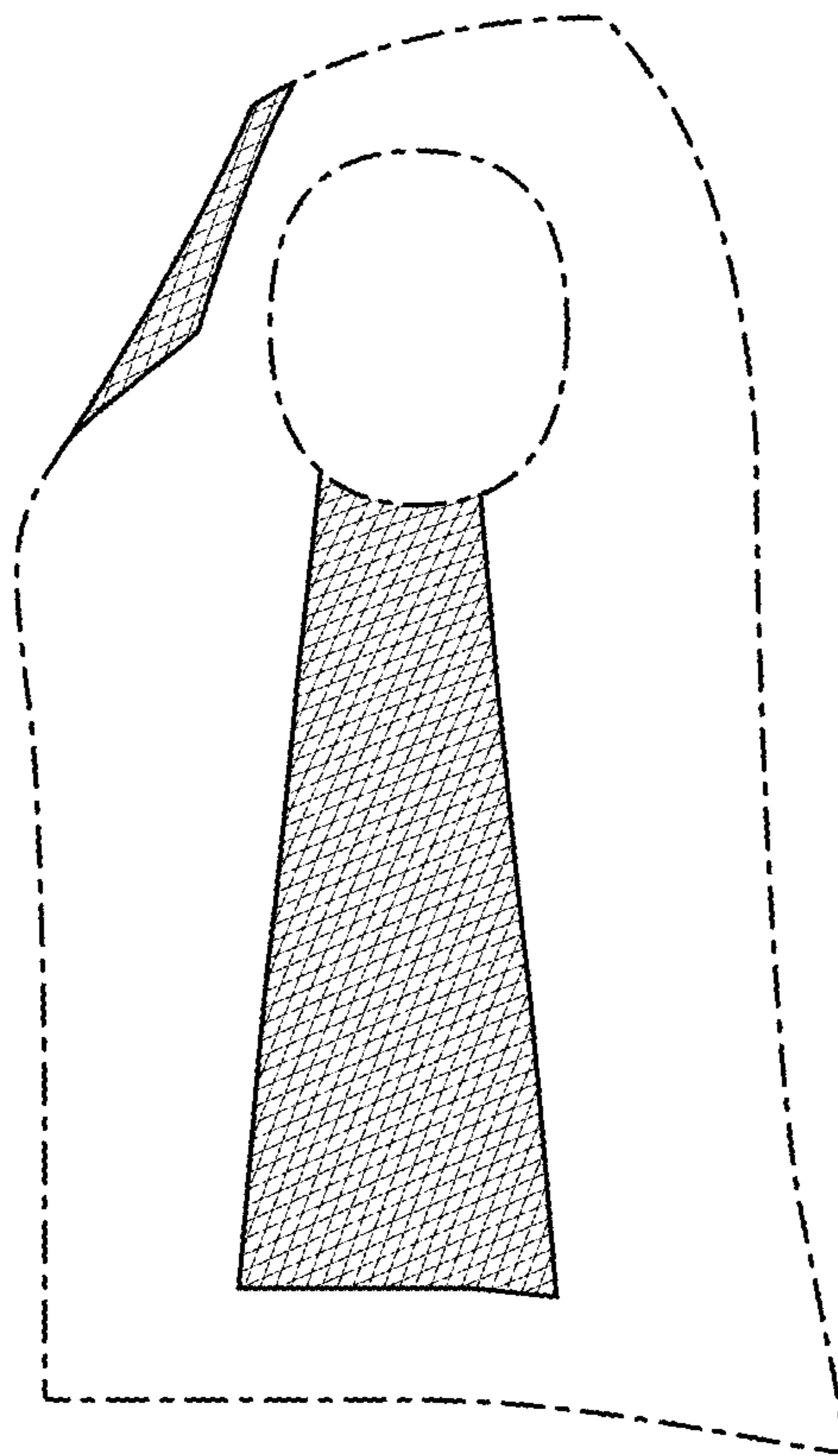

FIG. 10