



US00D770071S

(12) **United States Design Patent** (10) **Patent No.:** **US D770,071 S**
Windom et al. (45) **Date of Patent:** **** Oct. 25, 2016**

(54) **PEN LIGHT**
(71) Applicant: **Coast Cutlery Co.**, Portland, OR (US)

(72) Inventors: **Gregory David Windom**, Portland, OR (US); **Kam Fu Choo**, Vancouver, WA (US); **Shao Jian Feng**, Yangjiang (CN); **Hai Rong Shi**, Yangjiang (CN)

(73) Assignee: **Coast Cutlery Co.**, Portland, OR (US)

(**) Term: **15 Years**

(21) Appl. No.: **29/544,764**

(22) Filed: **Nov. 5, 2015**

(51) **LOC (10) Cl.** **26-02**

(52) **U.S. Cl.**
USPC **D26/49**

(58) **Field of Classification Search**
USPC D26/37, 38, 40, 46, 49, 51; 362/157, 362/158, 183, 184, 194-196, 200-208, 253
CPC F21L 2003/00; F21L 4/00; F21L 4/005; F21L 4/02; F21L 4/025; F21L 4/027; F21L 4/04; F21L 4/08; F21L 2005/00; F21L 7/00; F21L 11/00; F21L 13/00; F21L 13/04; F21L 13/08; F21L 14/02; F21L 17/00
See application file for complete search history.

(56) **References Cited**

U.S. PATENT DOCUMENTS

D419,704 S *	1/2000	Ting	D26/37
D430,321 S *	8/2000	Sharrah	D26/37
D495,442 S *	8/2004	Packard	D26/37
D530,030 S *	10/2006	Chou	D26/37
D578,236 S *	10/2008	Dalton	D26/49
D593,240 S *	5/2009	Caniparoli	D26/49
D622,428 S *	8/2010	Crawford	D26/37
D643,561 S *	8/2011	Maglica	D26/49
D649,275 S *	11/2011	Crawford	D26/49

(Continued)

Primary Examiner — Lakiya Rogers
Assistant Examiner — Carissa C Fitts

(74) *Attorney, Agent, or Firm* — Schwabe Williamson & Wyatt

(57) **CLAIM**

We claim the ornamental design for a pen light, as shown and described.

DESCRIPTION

FIG. 1 is a perspective view of the pen light;
FIG. 2 is a bottom end view of the pen light as illustrated in FIG. 1;
FIG. 3 is a top end view of the pen light as illustrated in FIG. 1;
FIG. 4 is a left side view of the pen light as illustrated in FIG. 1;
FIG. 5 is a front side view of the pen light as illustrated in FIG. 1;
FIG. 6 is a right side view of the pen light as illustrated in FIG. 1;
FIG. 7 is a back side view of the pen light as illustrated in FIG. 1;
FIG. 8 is a perspective view of the pen light with the top pulled out;
FIG. 9 is a bottom end view of the pen light as illustrated in FIG. 8;
FIG. 10 is a top end view of the pen light as illustrated in FIG. 8;
FIG. 11 is a left side view of the pen light as illustrated in FIG. 8;
FIG. 12 is a another left side view of the pen light as illustrated in FIG. 8, with the movable sleeve partially cut-away to show the top end of the pen light;
FIG. 13 is a front side view of the pen light as illustrated in FIG. 8;
FIG. 14 is a right side view of the pen light as illustrated in FIG. 8; and,
FIG. 15 is a back side view of the pen light as illustrated in FIG. 8.

1 Claim, 4 Drawing Sheets

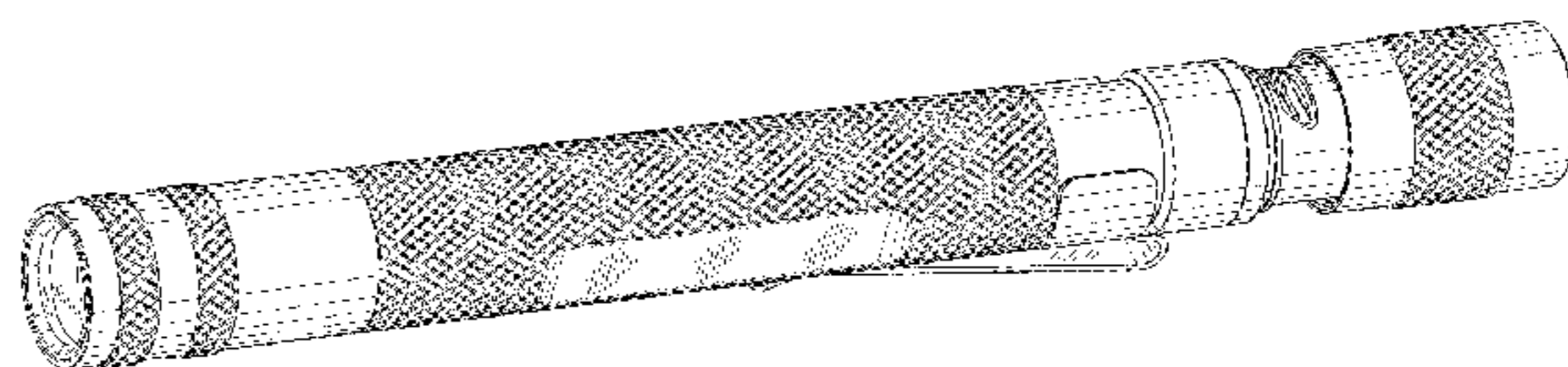
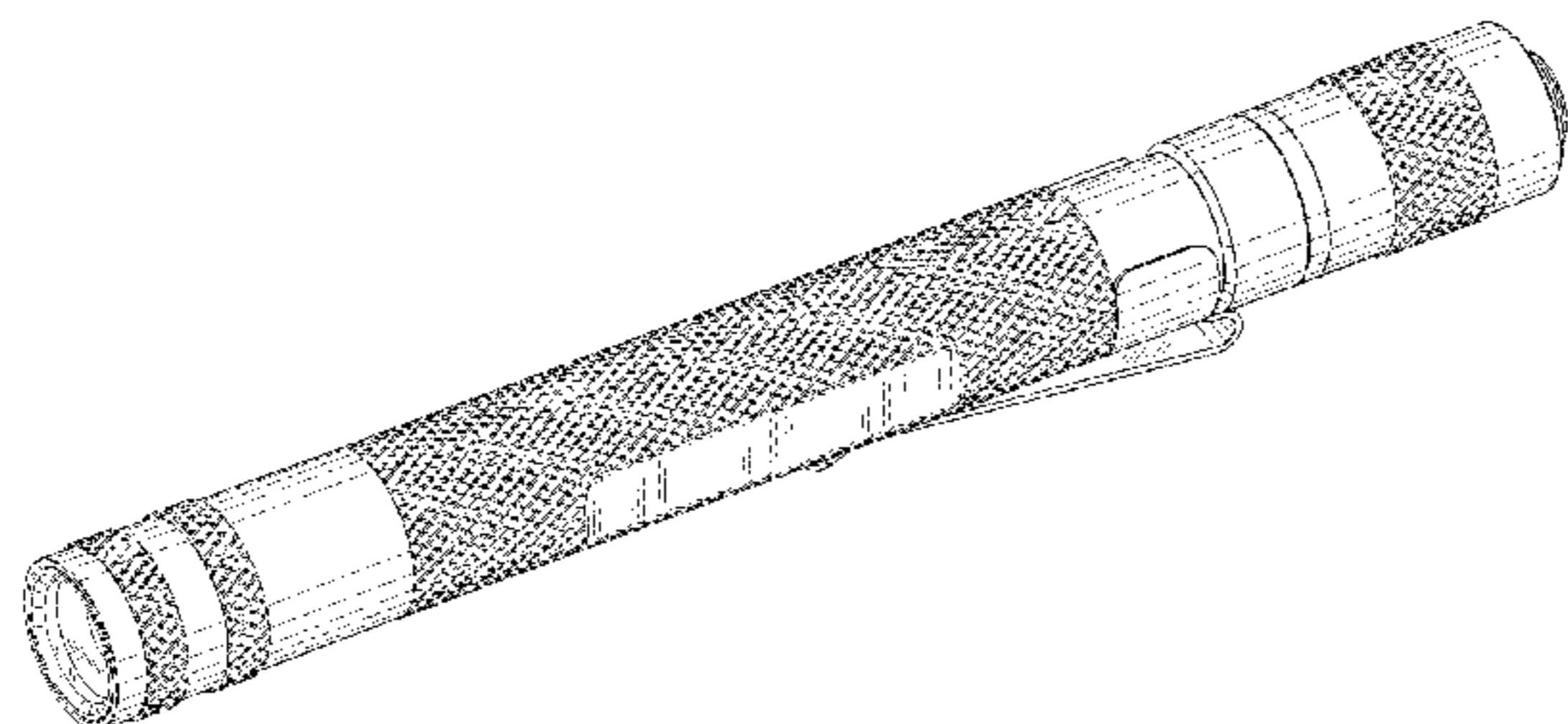

(56)

References Cited

U.S. PATENT DOCUMENTS

D655,027 S * 2/2012 Milz D26/49
D658,322 S * 4/2012 Wu D26/37
D675,358 S * 1/2013 Brands D26/49
D676,170 S * 2/2013 Feng D26/38

D704,368 S * 5/2014 Opolka D26/49
D729,963 S * 5/2015 Windom D26/38
D749,254 S * 2/2016 Robinson D26/37
D749,255 S * 2/2016 Robinson D26/37
D754,899 S * 4/2016 Cooper D26/44

* cited by examiner

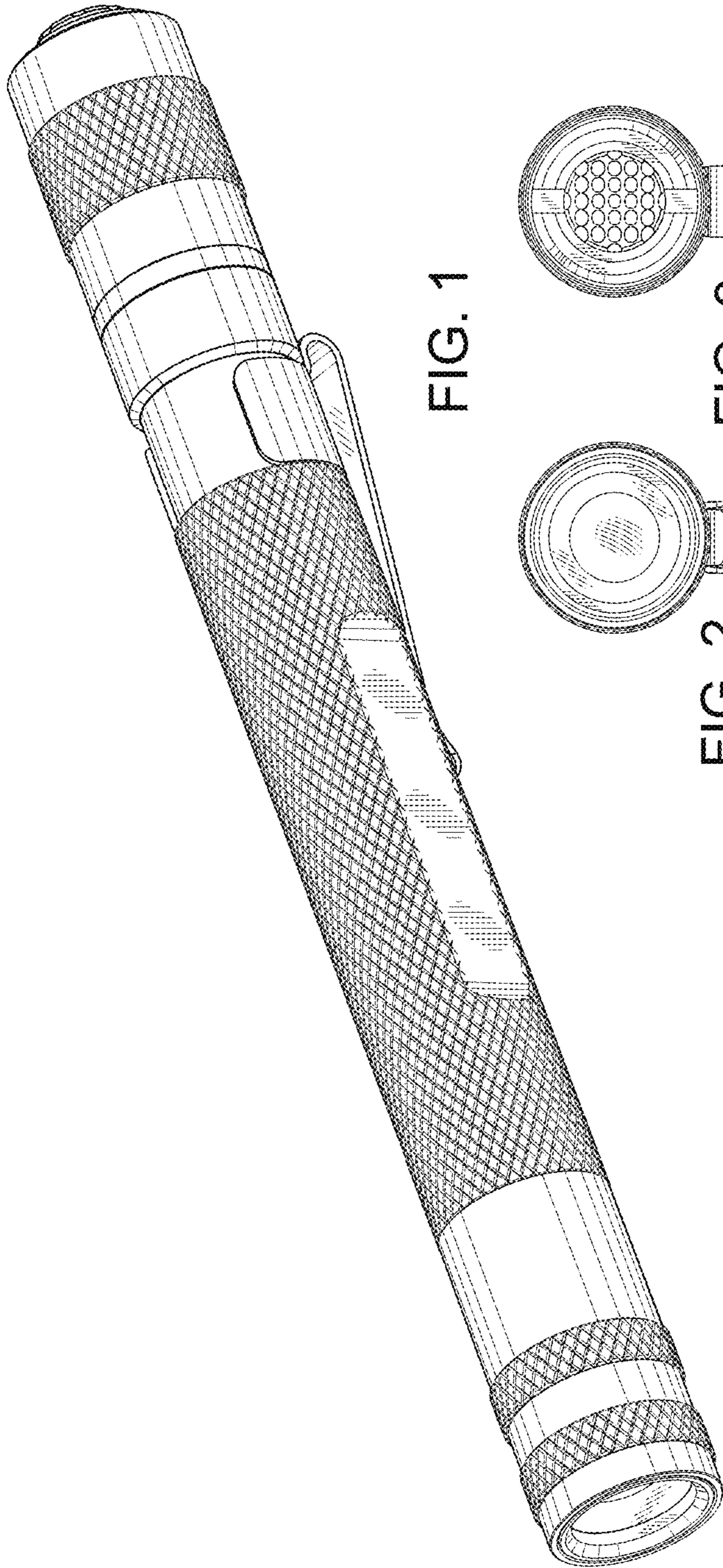

FIG. 1

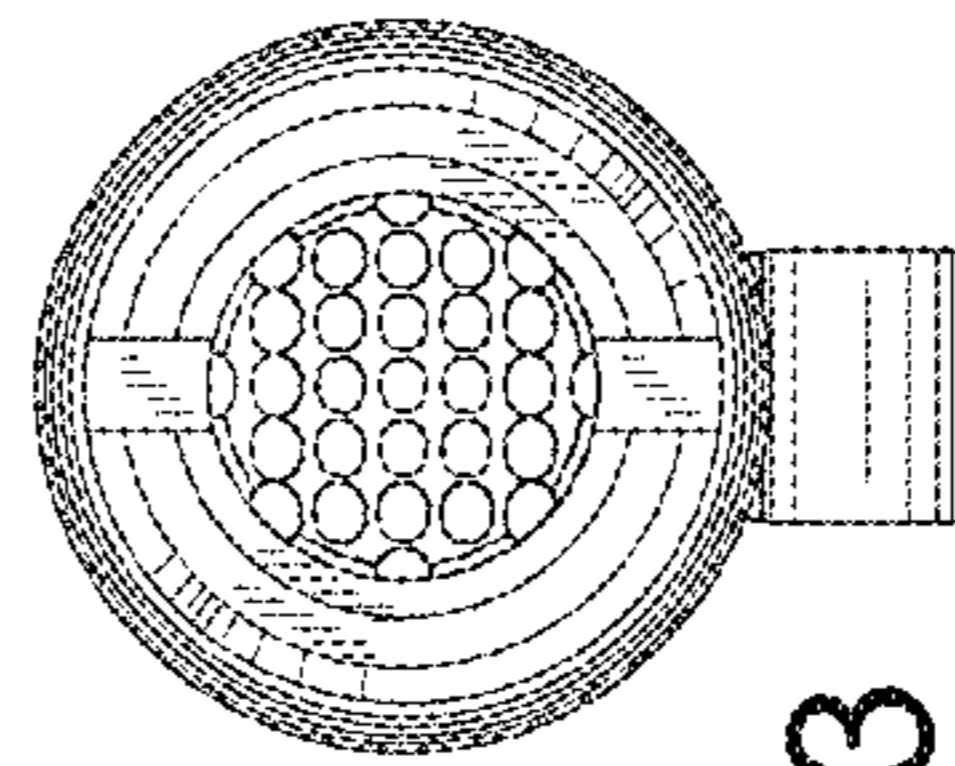

FIG. 3

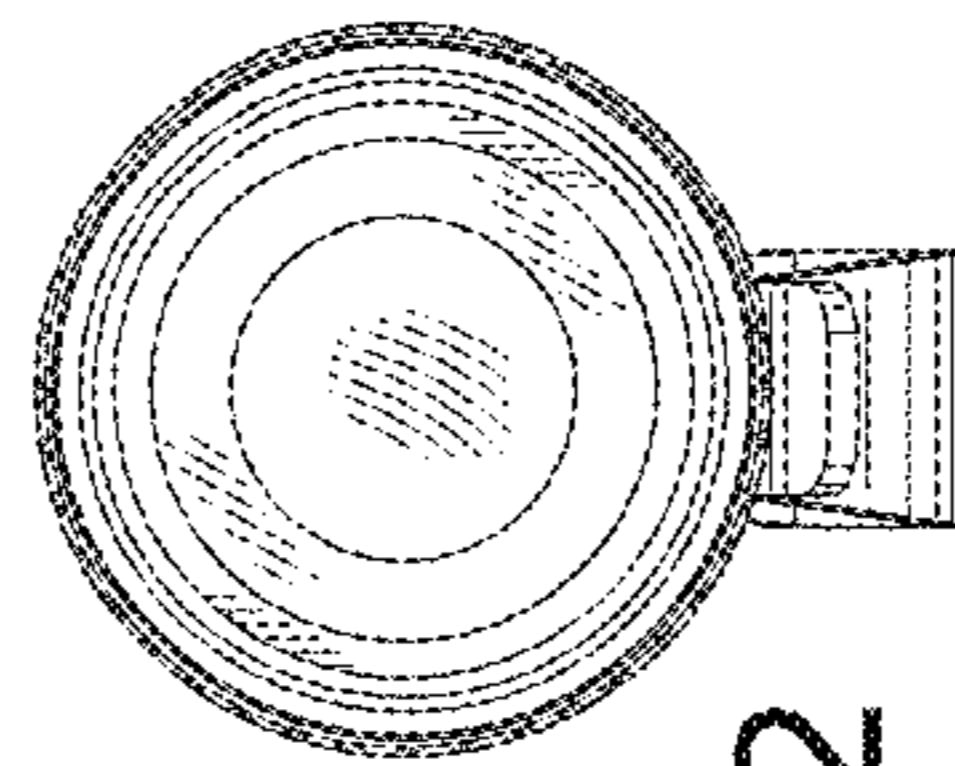

FIG. 2

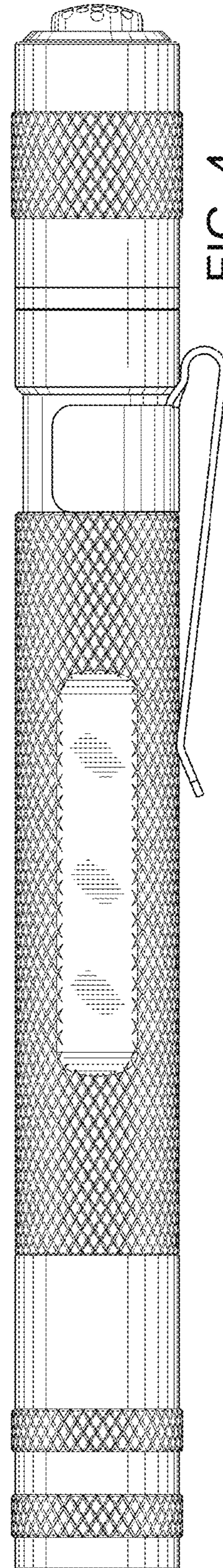

FIG. 4

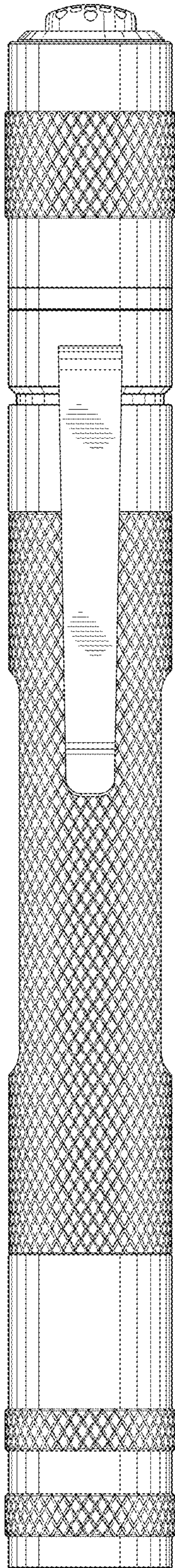

FIG. 5

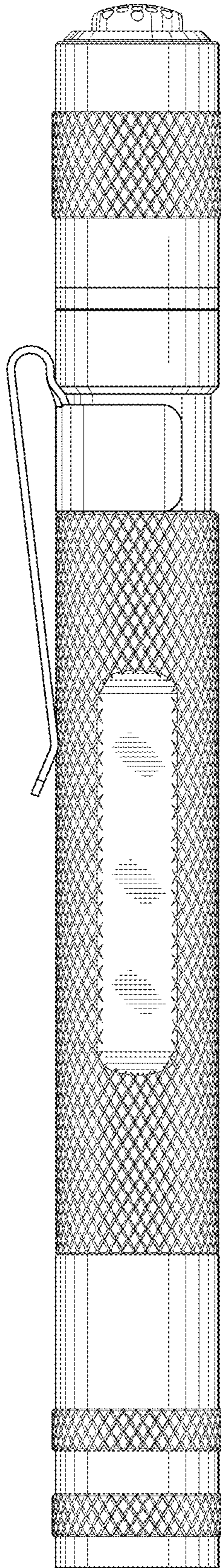

FIG. 6

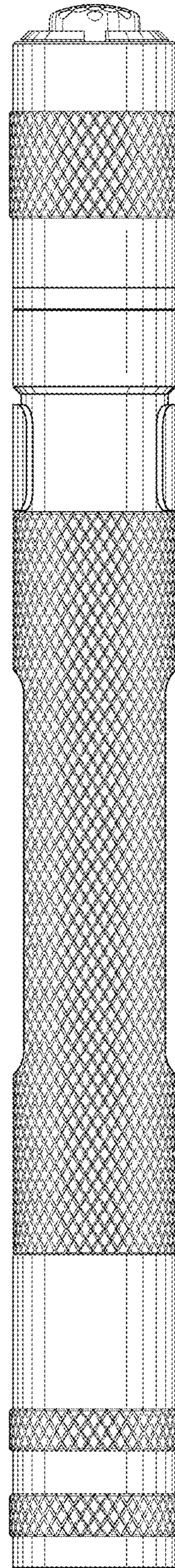

FIG. 7

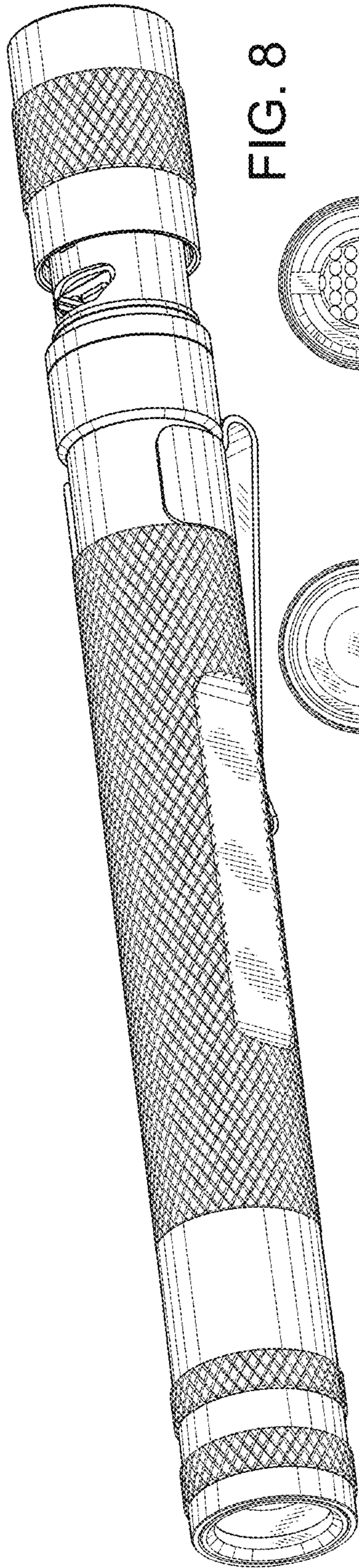

FIG. 8

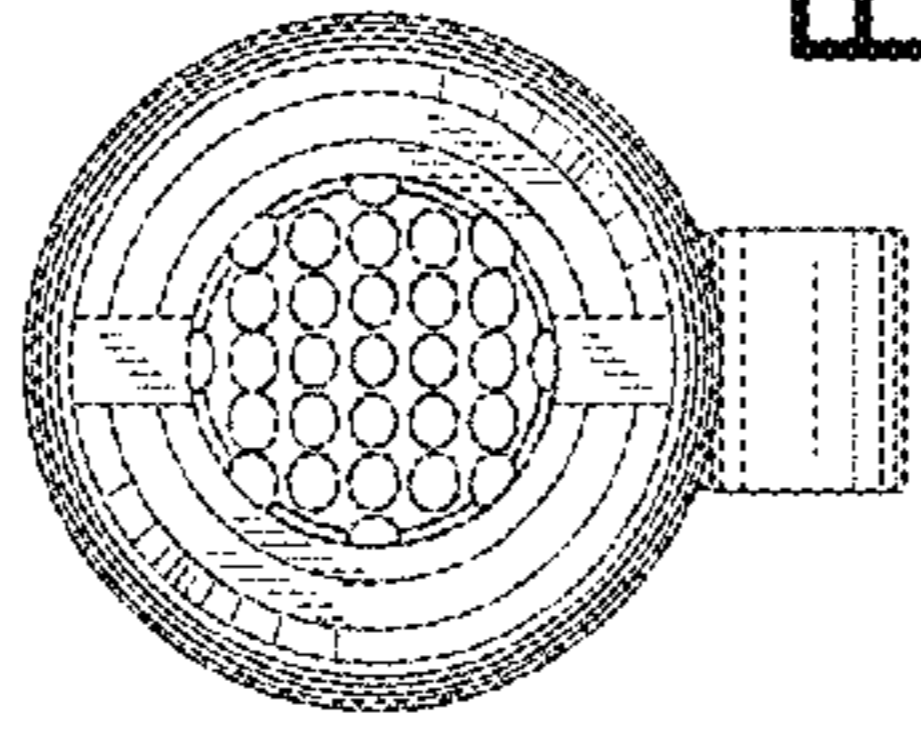

FIG. 9

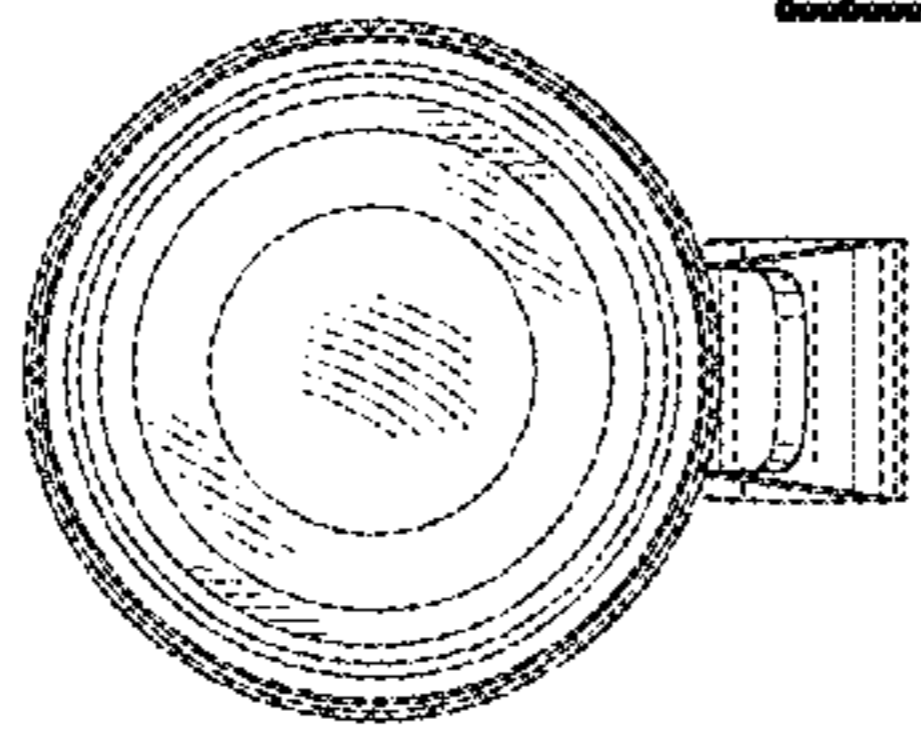

FIG. 10

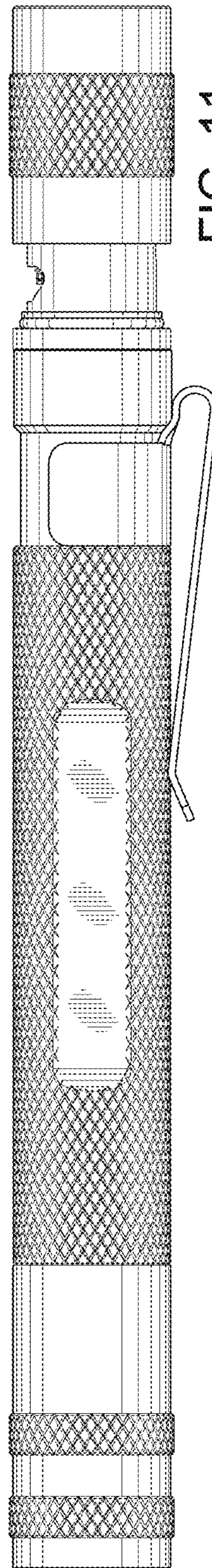

FIG. 11

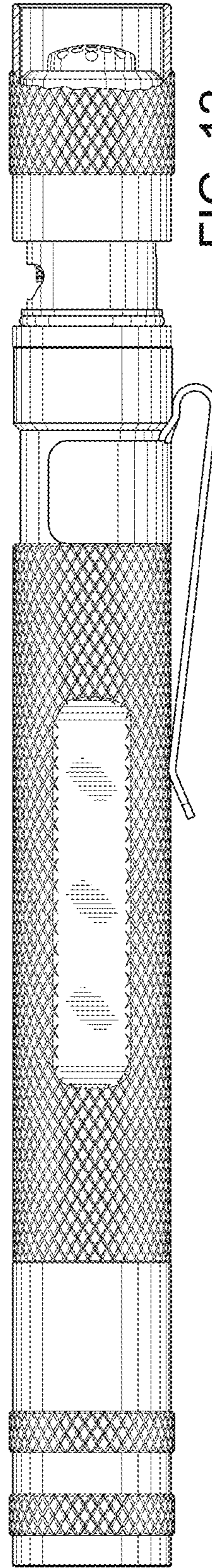

FIG. 12

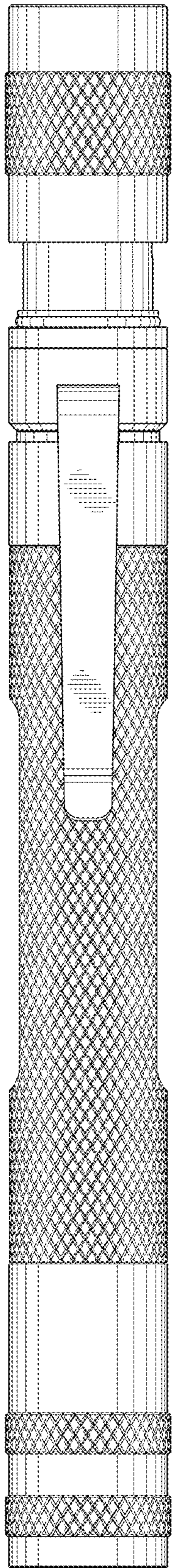

FIG. 13

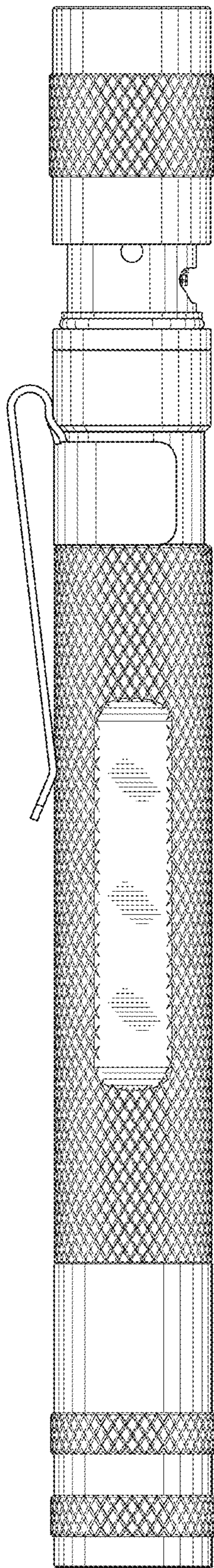

FIG. 14

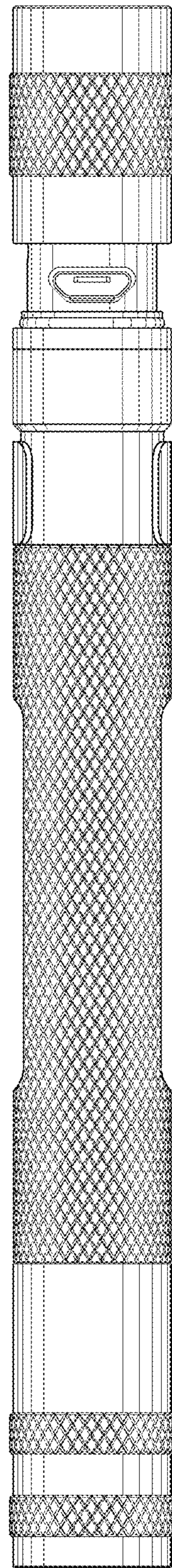

FIG. 15