



US00D770038S

(12) **United States Design Patent** (10) **Patent No.:** **US D770,038 S**
Ahlgrim et al. (45) **Date of Patent:** **** Oct. 25, 2016**

(54) **MEDICATION INJECTION DEVICE**

5,645,534 A 7/1997 Chanoch
5,674,204 A 10/1997 Chanoch
5,688,251 A 11/1997 Chanoch
5,820,602 A 10/1998 Kovelman et al.

(71) Applicant: **Eli Lilly and Company**, Indianapolis, IN (US)

(Continued)

(72) Inventors: **Dirk Ahlgrim**, Boston, MA (US); **Gen Suzuki**, Kanagawa (JP)

FOREIGN PATENT DOCUMENTS

(73) Assignee: **Eli Lilly and Company**, Indianapolis, IN (US)

EP 0937472 8/1999
EP 1095668 5/2001

(Continued)

(**) Term: **14 Years**

OTHER PUBLICATIONS

(21) Appl. No.: **29/495,028**

HumaPen® Savvio™ card, Eli Lilly and Company, 2013.

(22) Filed: **Jun. 26, 2014**

(Continued)

(51) **LOC (10) Cl.** **24-02**

(52) **U.S. Cl.**

USPC **D24/113**

(58) **Field of Classification Search**

USPC D24/112-114, 108, 133, 130, 127, 186;
606/181, 185; 604/264, 272, 187, 181,
604/184, 227

CPC A61M 5/178; A61M 3/00; A61M 5/20;
A61M 5/31; A61M 5/3146; A61M 5/3129;
A61M 5/3148; A61M 5/315

See application file for complete search history.

Primary Examiner — David Muller

(74) *Attorney, Agent, or Firm* — Edward J. Prein

(57) **CLAIM**

The ornamental design for a medication injection device, as shown and described.

DESCRIPTION

FIG. 1 is a perspective view of a medication injection device showing our new design;

FIG. 2 is a front view thereof;

FIG. 3 is a top view thereof;

FIG. 4 is bottom view thereof;

FIG. 5 is a side view thereof;

FIG. 6 is an opposite side view thereof; and,

FIG. 7 is a rear view thereof.

The cross-hatched annular region of the button in FIGS. 1 and 4 represents a contrasting color region visible on the button that forms part of the claimed design. The dash lines in FIGS. 1, 2 and 4 show a bottom portion and surround a front portion of the device which form no part of the claimed design.

(56) **References Cited**

U.S. PATENT DOCUMENTS

1,617,140 A 2/1927 Alland
D160,436 S 10/1950 Seibert
D303,020 S 8/1989 Reichmann
4,973,318 A 11/1990 Holm et al.
5,042,977 A 8/1991 Bechtold et al.
D328,611 S 8/1992 Longarzo
D330,079 S 10/1992 Dalling et al.
5,226,895 A 7/1993 Harris
5,226,896 A 7/1993 Harris
5,279,586 A 1/1994 Balkwill
5,383,865 A 1/1995 Michel
5,545,147 A 8/1996 Harris
5,626,566 A 5/1997 Petersen et al.

1 Claim, 2 Drawing Sheets

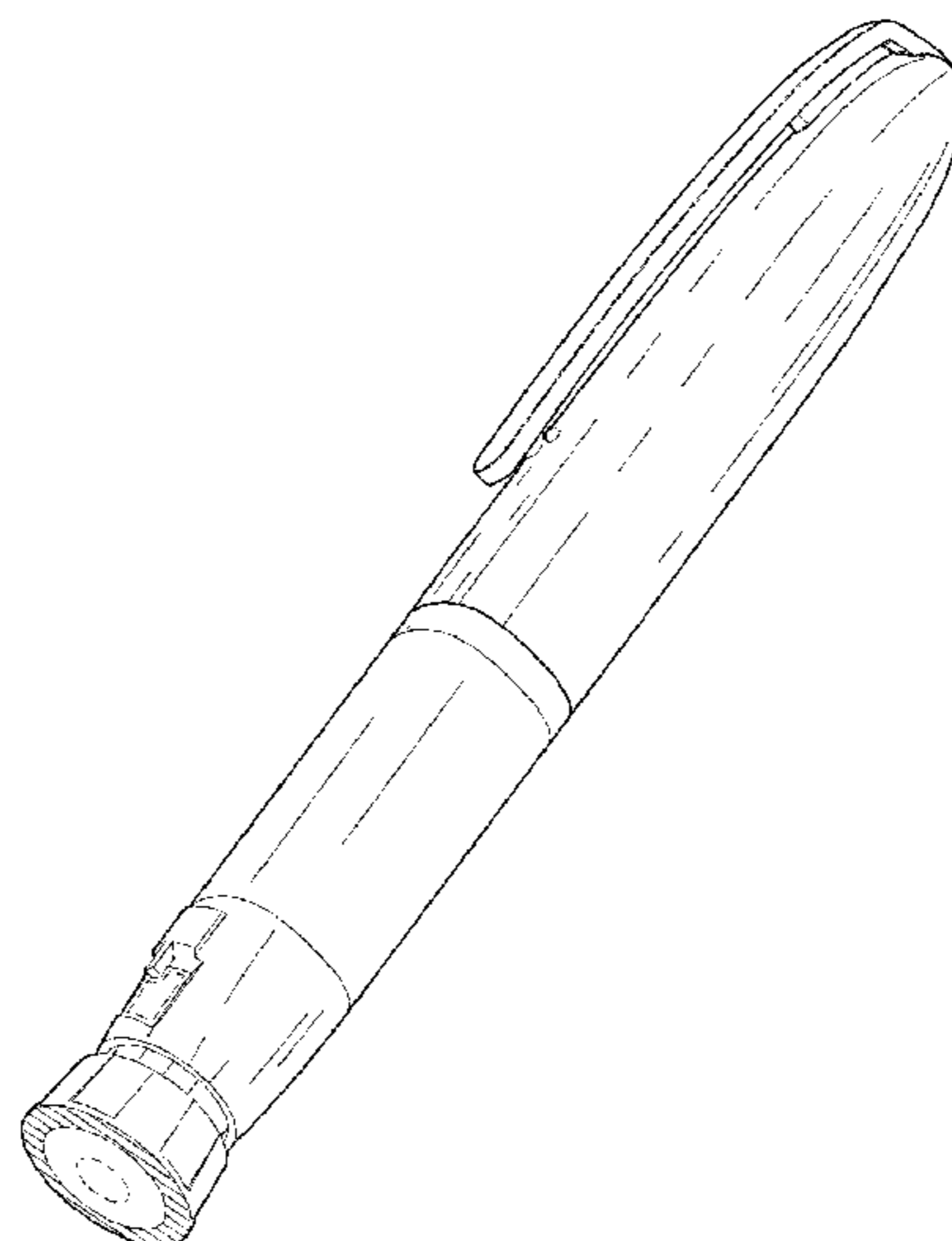

(56)

References Cited

U.S. PATENT DOCUMENTS

5,921,966 A 7/1999 Bendek et al.
 5,925,021 A 7/1999 Castellano et al.
 5,957,896 A 9/1999 Bendek et al.
 6,001,089 A 12/1999 Burroughs et al.
 6,004,297 A 12/1999 Steinfeldt-Jensen et al.
 6,048,336 A 4/2000 Gabriel
 D426,299 S 6/2000 Bydlon et al.
 6,193,698 B1 2/2001 Kirchhofer et al.
 6,221,046 B1 4/2001 Burroughs et al.
 6,277,099 B1 8/2001 Strowe et al.
 D462,760 S * 9/2002 Ahlgrim D24/112
 D479,599 S 9/2003 Bainton
 D479,600 S 9/2003 Bainton
 D479,601 S 9/2003 Tyce
 D479,602 S 9/2003 Bainton
 D479,603 S 9/2003 Tyce
 D479,747 S 9/2003 Bainton
 D479,748 S 9/2003 Tyce
 D492,027 S 6/2004 Tyce et al.
 D492,405 S 6/2004 Bainton
 D499,485 S 12/2004 Tyce
 D501,253 S 1/2005 Bainton
 D503,797 S 4/2005 Tyce
 D505,490 S 5/2005 Tyce
 D540,465 S 4/2007 Bainton
 7,241,278 B2 7/2007 Møller
 7,291,132 B2 11/2007 DeRuntz et al.
 D567,938 S * 4/2008 Shinohara D24/114
 D567,939 S * 4/2008 Mattigka D24/114
 D598,539 S 8/2009 Tyce
 D599,008 S 8/2009 Tyce
 D599,009 S 8/2009 Tyce
 D599,010 S 8/2009 Tyce
 D599,011 S 8/2009 Tyce
 D600,794 S 9/2009 Tyce
 D600,795 S 9/2009 Tyce
 D606,649 S 12/2009 Tyce
 D606,650 S 12/2009 Tyce
 D608,442 S 1/2010 Tyce
 D610,251 S 2/2010 Tyce
 D610,252 S 2/2010 Tyce
 D610,676 S 2/2010 Tyce
 D610,677 S 2/2010 Tyce
 D621,500 S 8/2010 Sanders et al.
 D626,216 S 10/2010 Tyce
 D641,077 S 7/2011 Sanders et al.
 D651,305 S 12/2011 Hawley et al.
 D652,136 S 1/2012 Hawley et al.
 D685,464 S 7/2013 Sanders
 D687,544 S 8/2013 Stephan et al.
 8,556,864 B2 10/2013 Veasey et al.

8,603,044 B2 12/2013 Veasey et al.
 D697,617 S 1/2014 Sanders
 D703,314 S * 4/2014 Schneider D24/113
 D703,315 S * 4/2014 Sanders D24/113
 D703,316 S 4/2014 Sanders
 D703,809 S 4/2014 Sanders
 D703,810 S * 4/2014 Sanders D24/113
 D716,442 S * 10/2014 Magome D24/113
 D717,428 S 11/2014 Sendatzki et al.
 D717,940 S * 11/2014 Magome D24/113
 D719,257 S 12/2014 Magome et al.
 D722,158 S 2/2015 Magome et al.
 D724,721 S * 3/2015 Geert-Jensen D24/113
 D725,771 S * 3/2015 Sendatzki D24/113
 D734,450 S * 7/2015 Geert-Jensen D24/113

FOREIGN PATENT DOCUMENTS

WO 9810814 3/1998
 WO 9943283 9/1999
 WO 0110484 2/2001
 WO 02092153 11/2002

OTHER PUBLICATIONS

Humalog® Brochure, Eli Lilly and Company, 2014.
 United HealthCare Formulary Sheet, Eli Lilly and Company, 2014.
 NovoLog® Mix 70/30 FlexPen® Brochure, Novo Nordisk, 2013.
 Forteo® User Manual, Eli Lilly and Company, 2011.
 HumatroPen® 12 mg User Manual, Eli Lilly and Company, 2012.
 Levemir® FlexTouch® Brochure, 2014.
 Norditropin® FlexPro® 5mg, 10mg, and 15mg leaflet, Novo Nordisk, 2011.
 NovoPen® 4 User Manual, Novo Nordisk, 2009.
 NovoPen® 5 Quick Guide, Novo Nordisk, 2012.
 NovoPen Echo® Quick Guide, Novo Nordisk, 2013.
 Victoza® Instructions For Use, Novo Nordisk, 2015.
 KwikPen™ Pocket Guide, Eli Lilly and Company, 2013.
 NovoPen® 3 Brochure, Novo Nordisk, 1999.
 Brochure in Japanese, Eli Lilly and Company, 1999.
 Innovo® Brochure, Novo Nordisk, 2000.
 OptiClik™ Instruction Leaflet, Aventis.
 Lantus OptiSet Brochure, Aventis.
 TactiPen® Patient Brochure, Sanofi.
 NovoLet® Brochure, Novo Nordisk.
 Die OptiPen® Familie Brochure, Aventis.
 InnoLet® Brochure, Novo Nordisk.

* cited by examiner

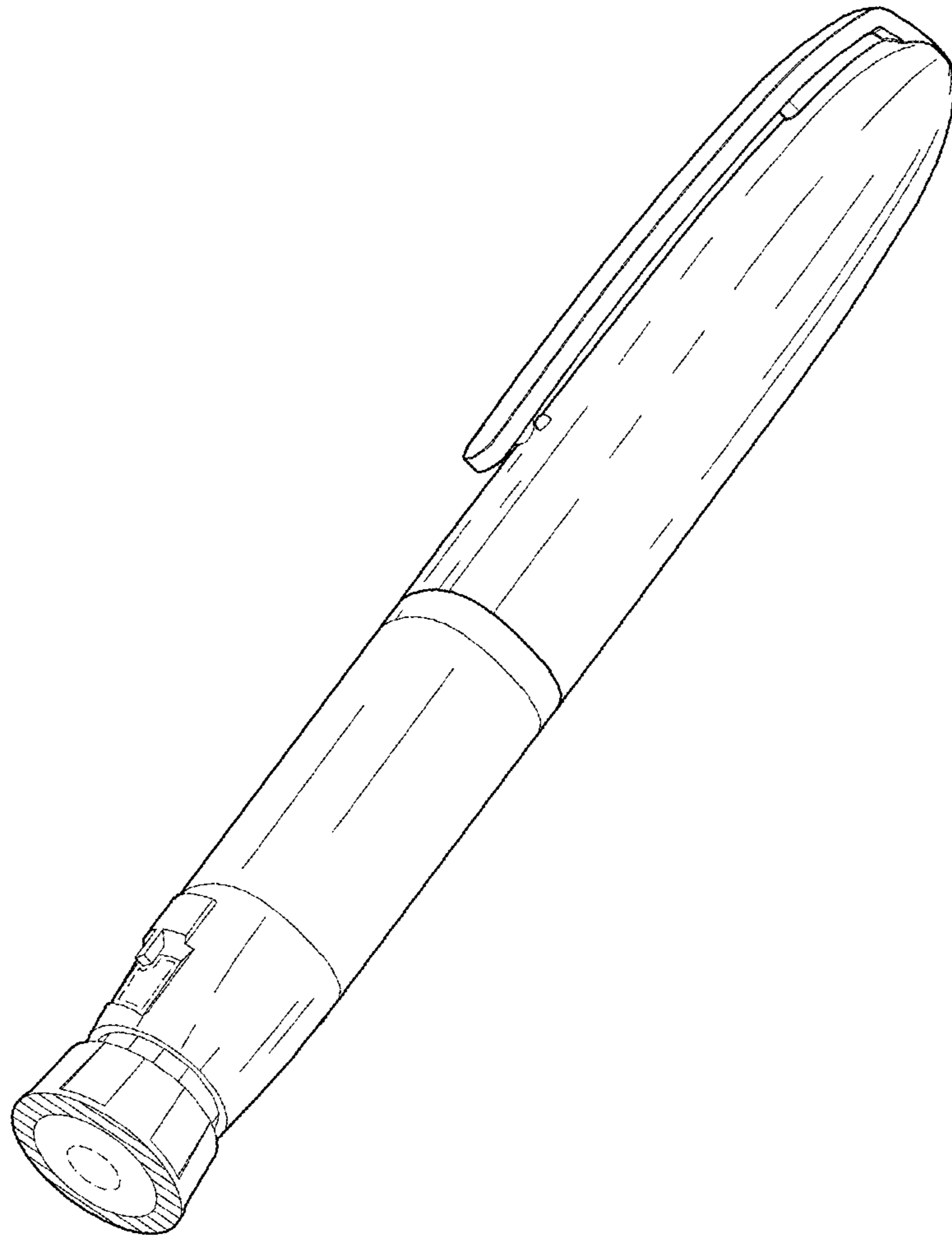

Fig. 1

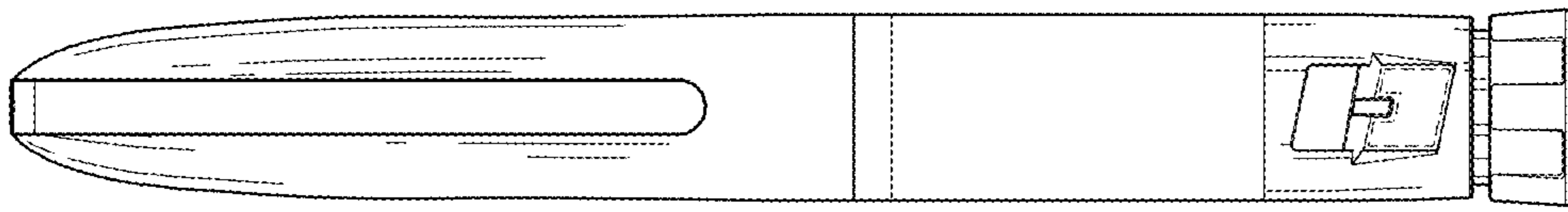

Fig. 2

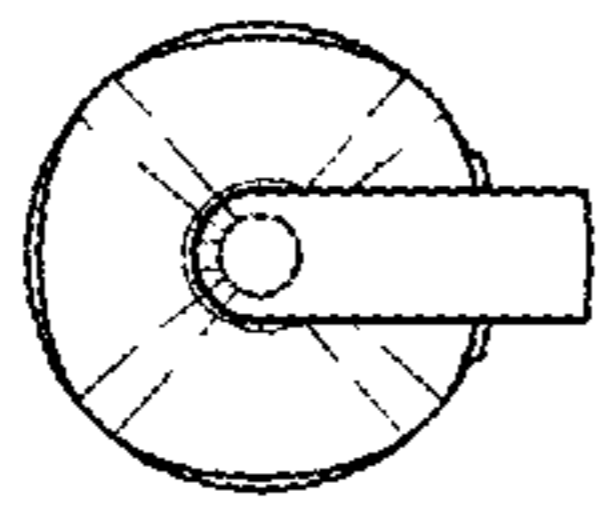

Fig. 3

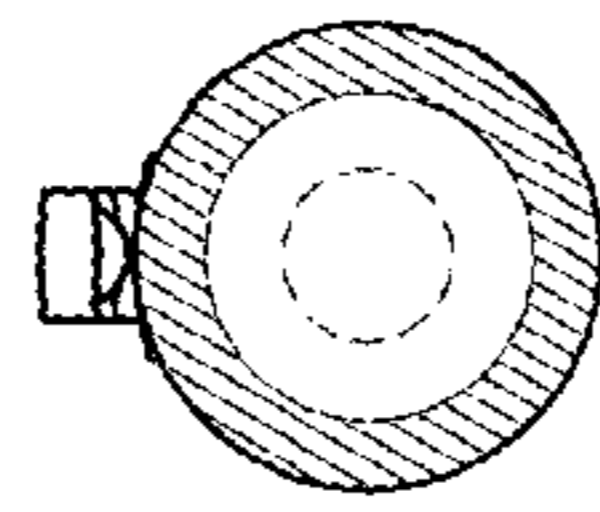

Fig. 4

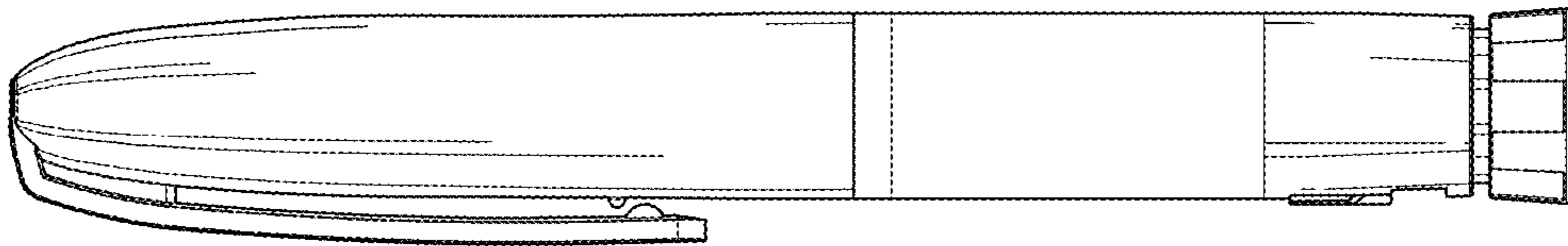

Fig. 5

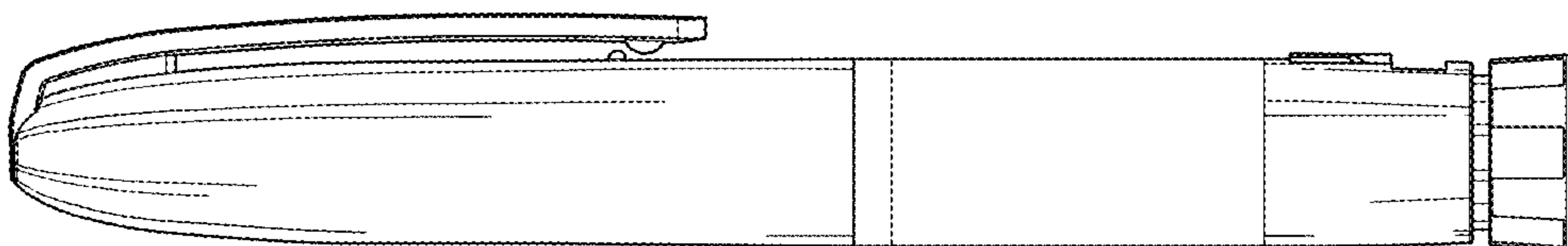

Fig. 6

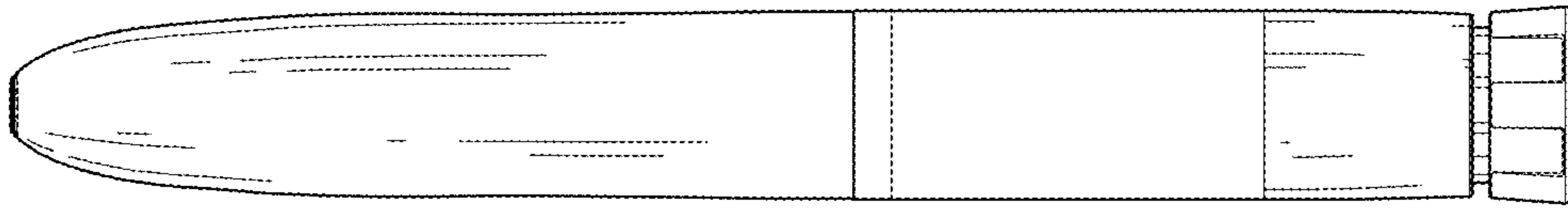

Fig. 7