



US00D76994S

(12) **United States Design Patent**
Hunter

(10) **Patent No.:** **US D769,994 S**
(45) **Date of Patent:** **** Oct. 25, 2016**

- (54) **PUTTER HEAD**
- (71) Applicant: **CALLAWAY GOLF COMPANY**,
Carlsbad, CA (US)
- (72) Inventor: **William L. Hunter**, San Diego, CA
(US)
- (73) Assignee: **Callaway Golf Company**, Carlsbad,
CA (US)
- (**) Term: **15 Years**
- (21) Appl. No.: **29/538,325**
- (22) Filed: **Sep. 2, 2015**
- (51) **LOC (10) Cl.** **21-02**
- (52) **U.S. Cl.**
USPC **D21/743**
- (58) **Field of Classification Search**
USPC D21/736-746
CPC A63B 53/065; A63B 53/0487; A63B 53/00;
A63B 53/04; A63B 53/007
See application file for complete search history.

D299,043 S *	12/1988	Antonious	D21/740
D300,758 S *	4/1989	Antonious	D21/740
D300,759 S *	4/1989	Antonious	D21/740
D322,109 S *	12/1991	Antonious	D21/740
D322,111 S *	12/1991	Antonious	D21/740
D483,086 S *	12/2003	Schweigert	D21/736
7,326,128 B2 *	2/2008	Cole	A63B 53/0487 473/335
D625,374 S *	10/2010	Hettinger	D21/743
D641,438 S *	7/2011	Rollinson	D21/736
8,382,603 B1 *	2/2013	Hong	A63B 53/007 473/226

* cited by examiner

Primary Examiner — Mitchell Siegel
(74) *Attorney, Agent, or Firm* — Rebecca Hanovice;
Michael Catania; Sonia Lari

(57) **CLAIM**
The ornamental design for a putter head, as shown and described.

DESCRIPTION

FIG. 1 is a rear perspective view of a the putter head as claimed herein;
FIG. 2 is a rear elevational view thereof;
FIG. 3 is a front elevational view thereof;
FIG. 4 is a right side elevational view thereof;
FIG. 5 is a left side elevational view thereof;
FIG. 6 is a top plan view thereof; and,
FIG. 7 is a bottom plan view thereof.
The broken lines are included for the purpose of illustration and form no part of the claimed design.

1 Claim, 4 Drawing Sheets

- (56) **References Cited**
U.S. PATENT DOCUMENTS
- | | | | | |
|--------------|--------|-----------|-------|---------|
| D220,844 S * | 6/1971 | Letters | | D21/740 |
| D223,031 S * | 2/1972 | Ernst | | D21/740 |
| D256,824 S * | 9/1980 | Ward | | D21/736 |
| D260,160 S * | 8/1981 | Giebel | | D21/739 |
| D267,738 S * | 1/1983 | Giebel | | D21/739 |
| D293,926 S * | 1/1988 | Antonious | | D21/740 |
| D294,059 S * | 2/1988 | Antonious | | D21/740 |

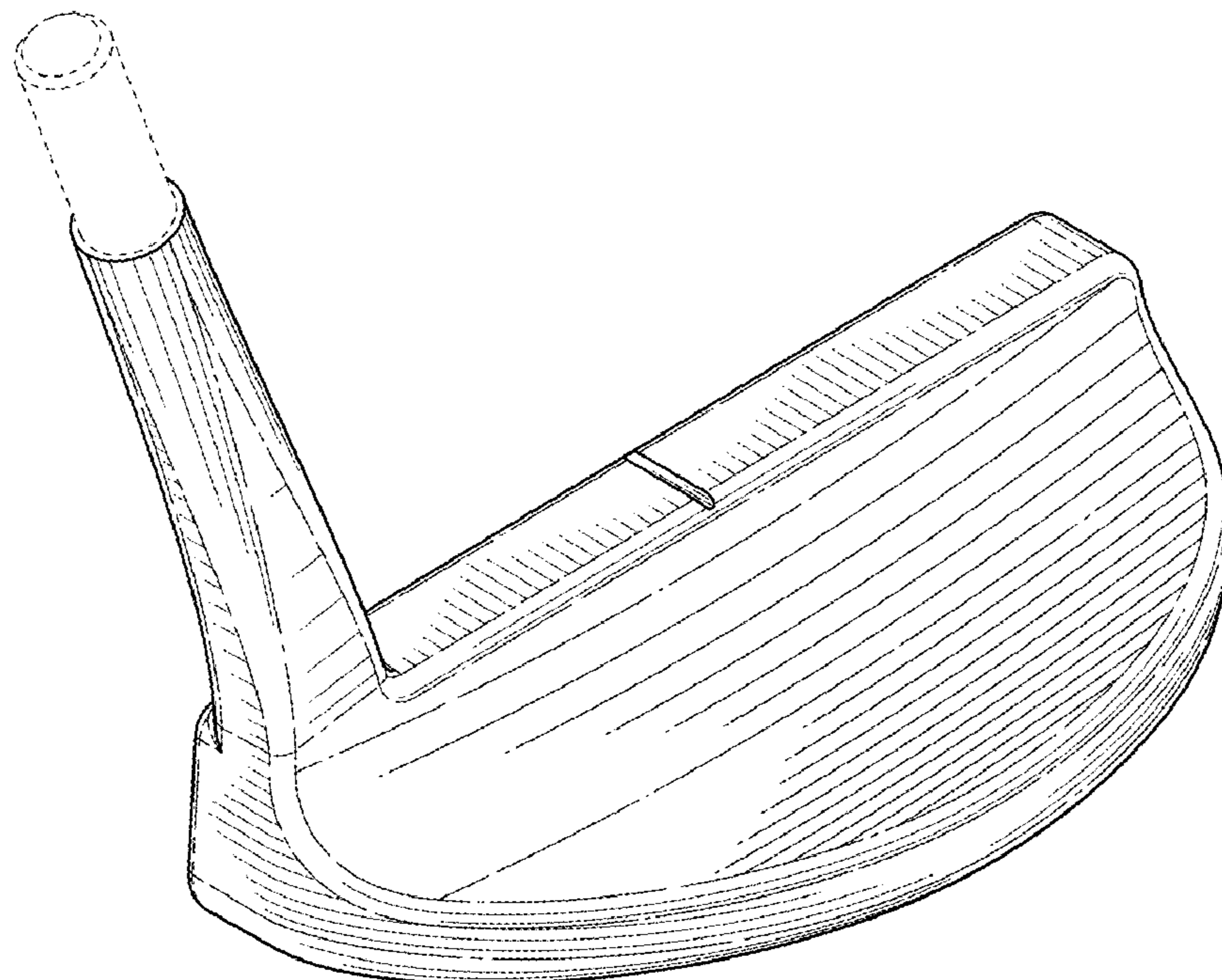

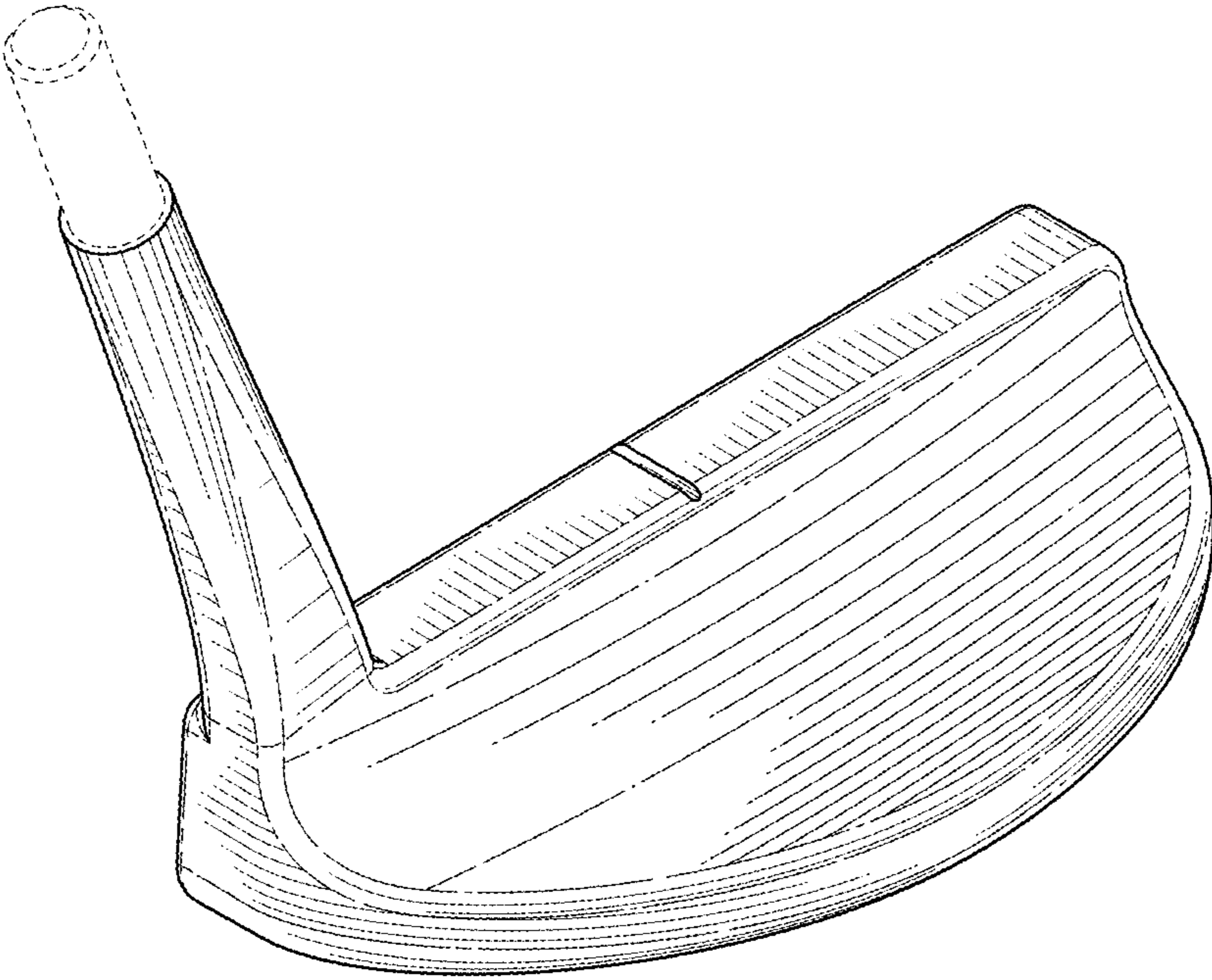

FIG. 1

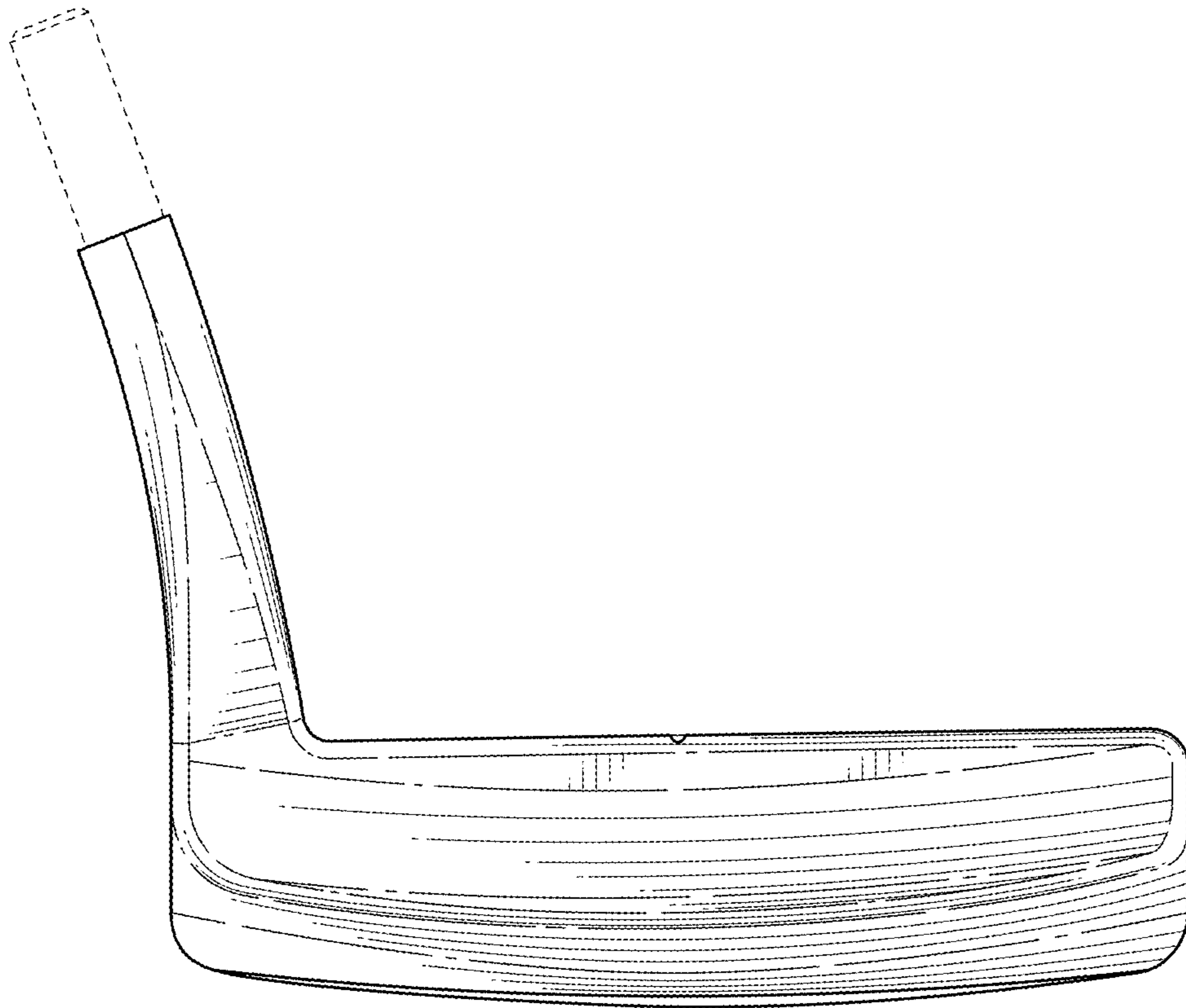

FIG. 2

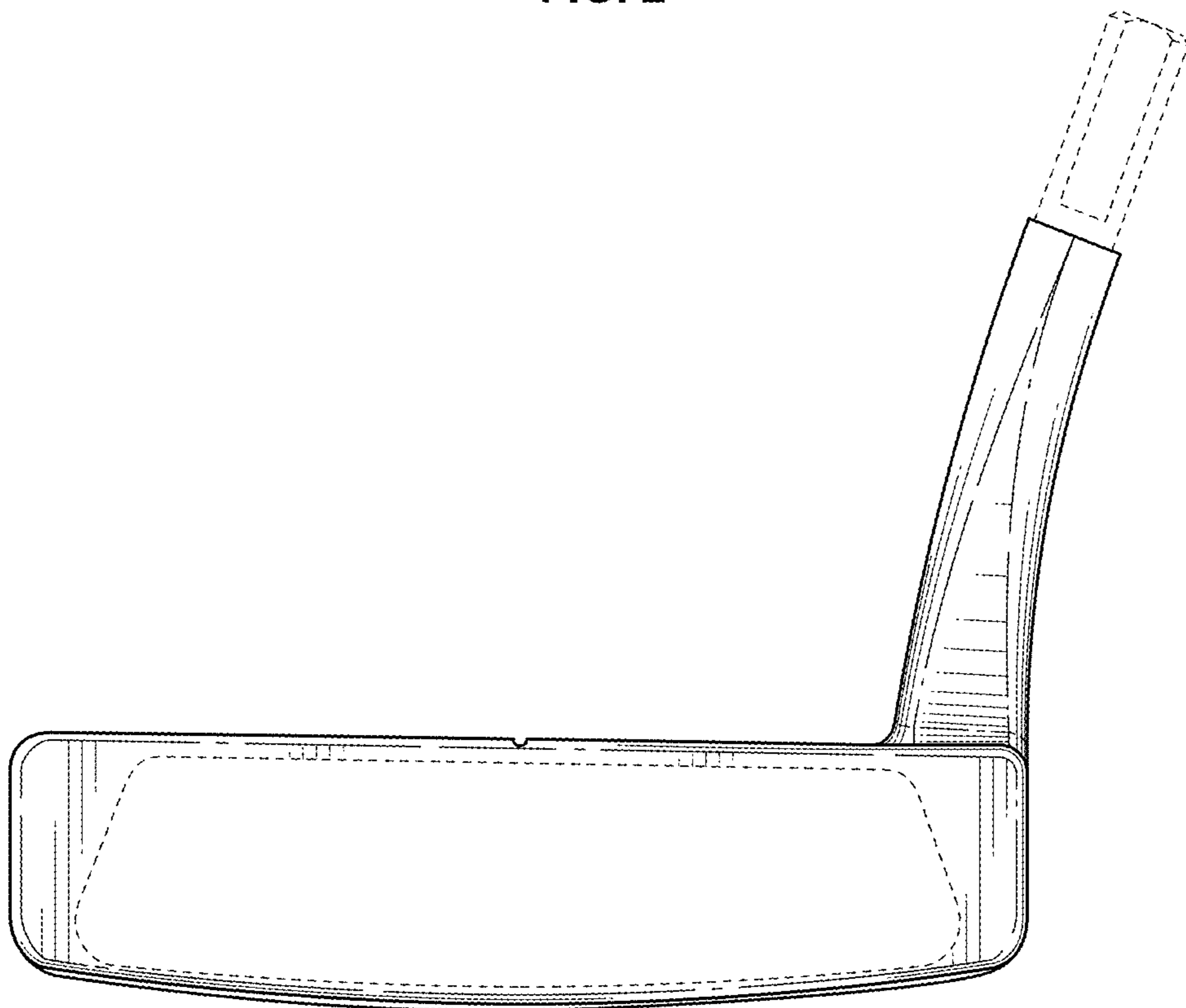

FIG. 3

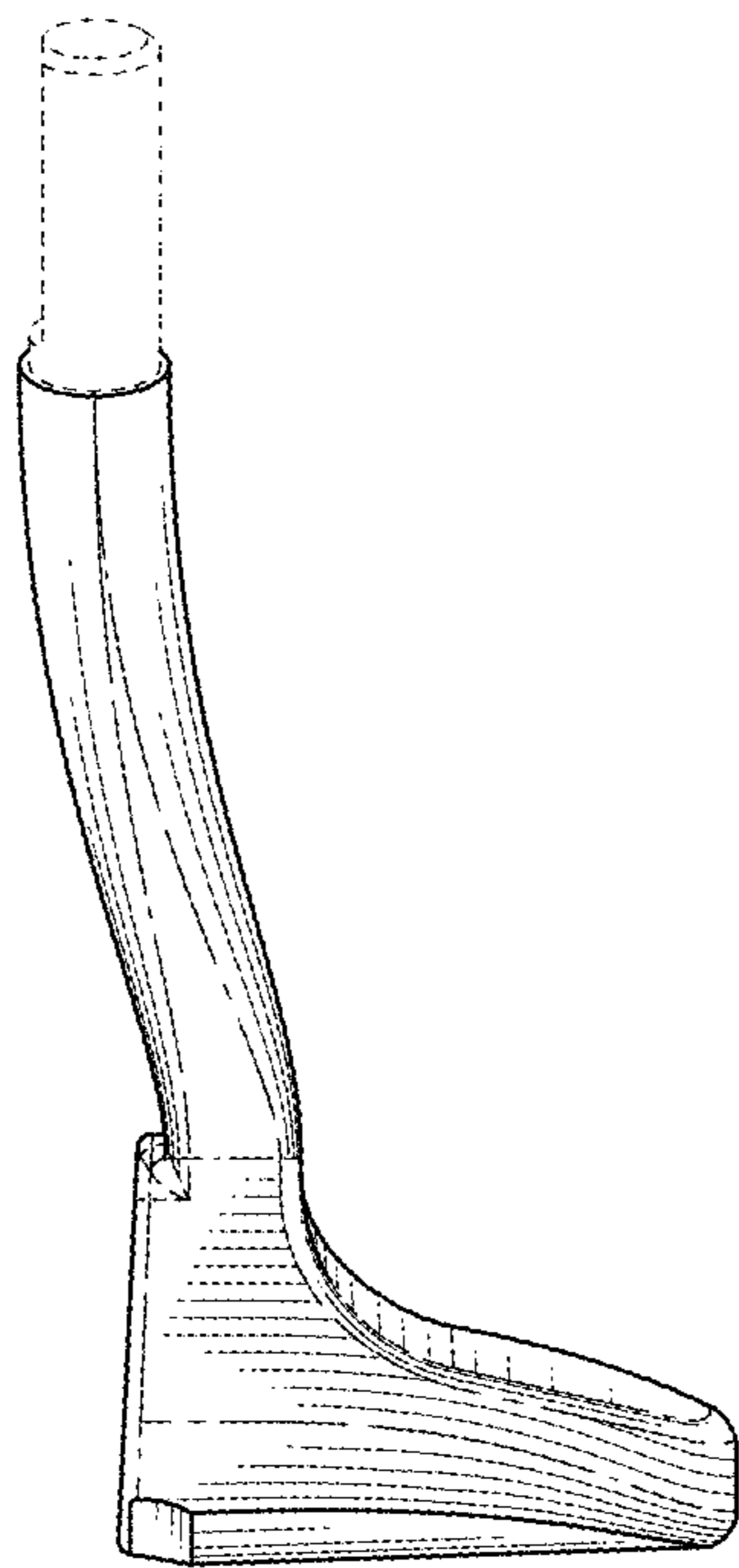

FIG. 4

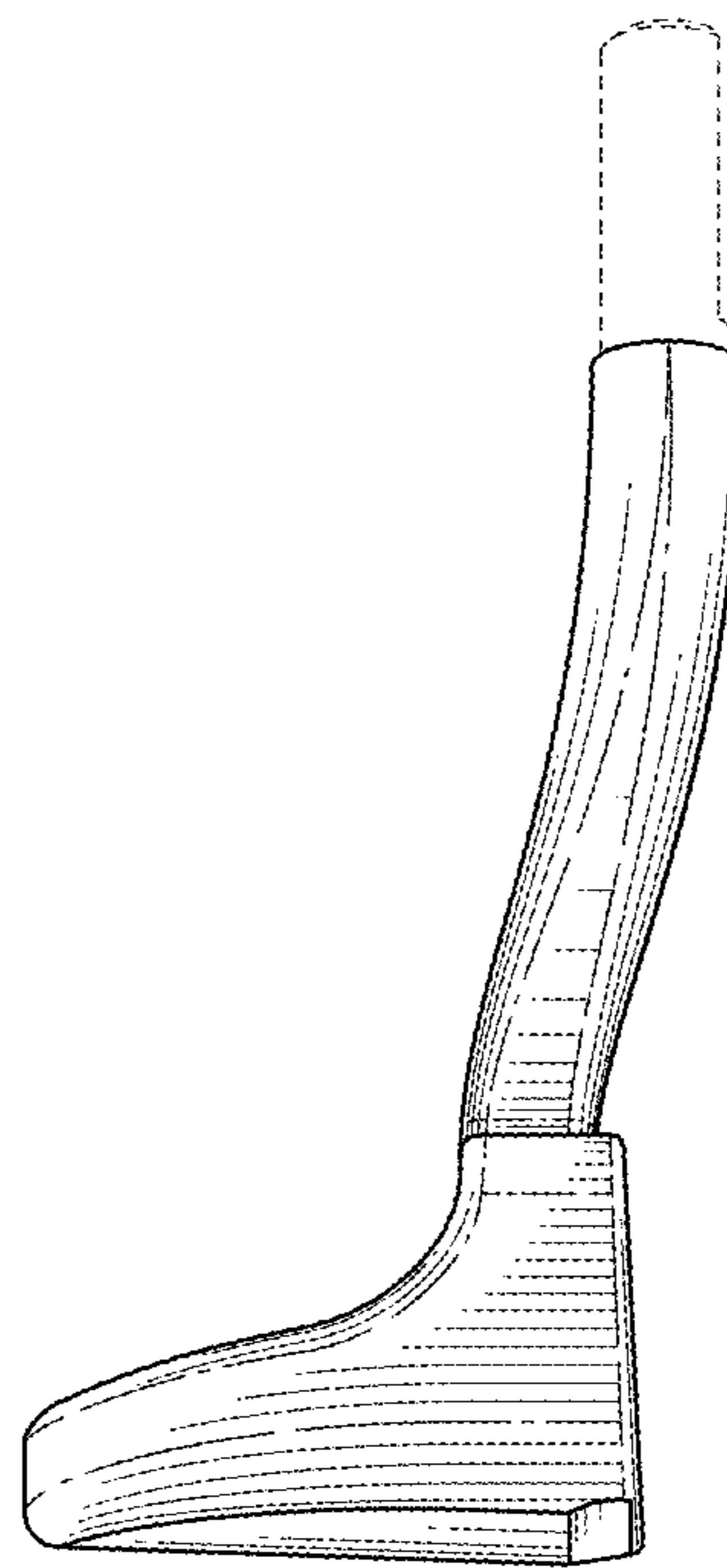

FIG. 5

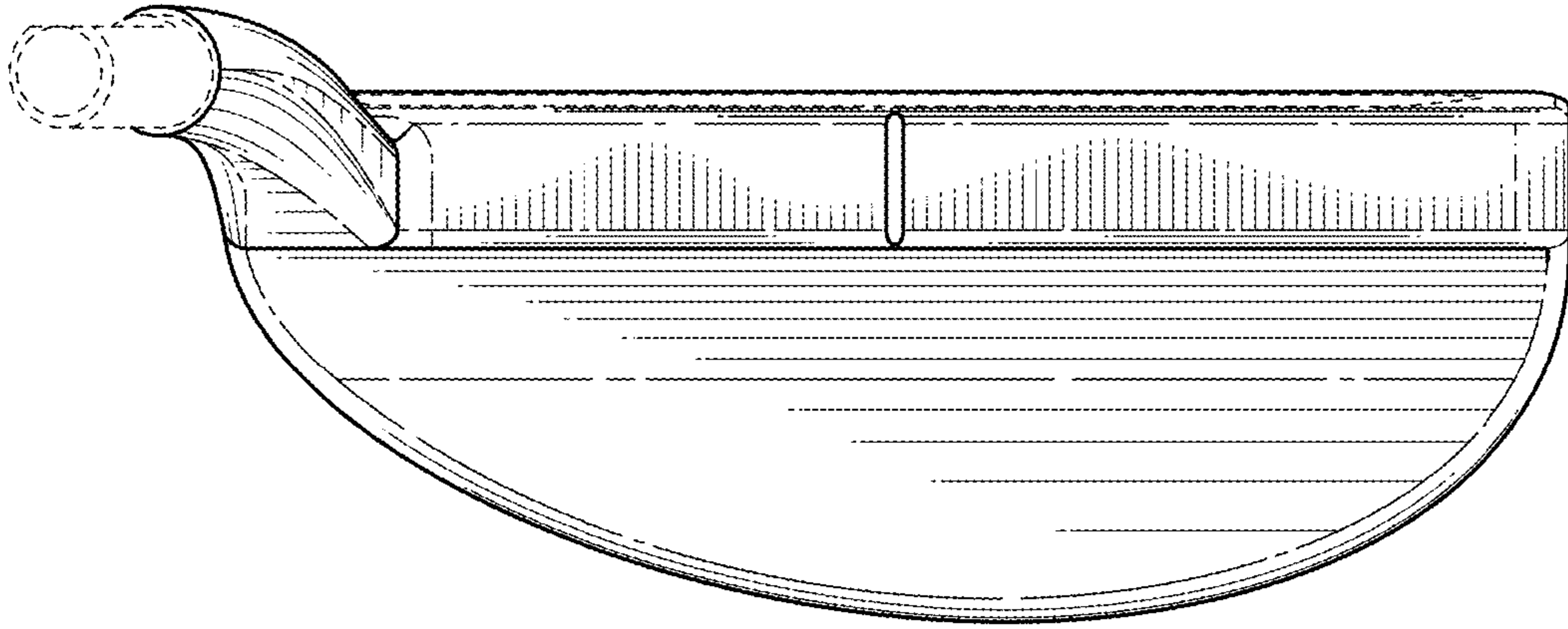

FIG. 6

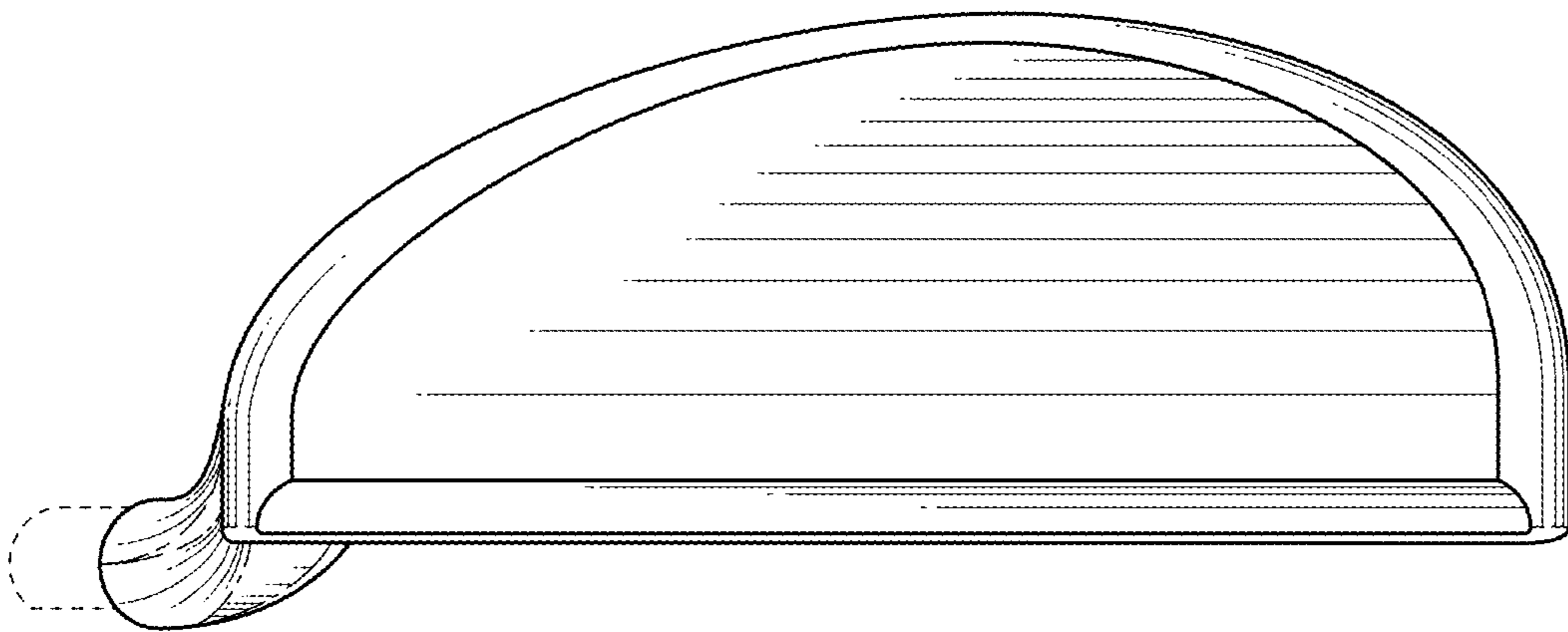

FIG. 7