

US00D769965S

(12) **United States Design Patent**
Clark, III et al.

(10) **Patent No.:** **US D769,965 S**
(45) **Date of Patent:** **** Oct. 25, 2016**

(54) **DESKTOP MULTIFUNCTION MACHINE**

(71) Applicant: **Xerox Corporation**, Norwalk, CT (US)

(72) Inventors: **William T Clark, III**, Pittsford, NY (US); **Donald A Brown**, Honeoye Falls, NY (US); **Megumi Okubo**, Kanagawa (JP)

(73) Assignee: **Xerox Corporation**, Norwalk, CT (US)

(**) Term: **14 Years**

(21) Appl. No.: **29/501,410**

(22) Filed: **Sep. 4, 2014**

(51) **LOC (10) Cl.** **14-02**

(52) **U.S. Cl.**
USPC **D18/55**

(58) **Field of Classification Search**

USPC D18/36-9, 5, 54, 54.1, 55, 4.4, 4.5, 4.6, D18/14, 19, 36-39, 50; D14/420-425, D14/462-470; 400/613, 613.1-613.4, 400/690.1-690.4, 691-694

CPC B41J 3/4074; B41J 3/4075; B41J 11/58; B41J 13/00; B41J 13/106; B41J 15/12; B41J 17/00; B41J 29/02; B41J 29/08

See application file for complete search history.

(56) **References Cited**

U.S. PATENT DOCUMENTS

D435,858 S * 1/2001 Hatanaka D18/39
D451,124 S * 11/2001 Isomoto D18/39
D493,817 S * 8/2004 Yoshida D18/39

D501,019 S * 1/2005 Yoshida D18/39
D502,210 S * 2/2005 Katori D14/463
D526,351 S * 8/2006 Yamamoto D18/55
D574,886 S * 8/2008 Mase D18/55
D575,330 S * 8/2008 Egami D18/55
D613,792 S * 4/2010 Suzuki D18/55
D614,235 S * 4/2010 Nakata D18/55
D622,762 S * 8/2010 Egami D18/55
D643,464 S * 8/2011 Sato D18/55
8,570,624 B2 * 10/2013 Nagashima G03G 15/60
358/1.1
D697,967 S * 1/2014 Fukasawa D18/55
D726,250 S * 4/2015 Kim D18/55
D727,415 S * 4/2015 Takeda D18/53

* cited by examiner

Primary Examiner — Cathy Anne MacCormac

(74) *Attorney, Agent, or Firm* — Thomas E. Hilloun

(57) **CLAIM**

The ornamental design for a desktop multifunction machine, as shown and described.

DESCRIPTION

FIG. 1 is a perspective view of a desktop multifunction machine in accordance with the present invention;

FIG. 2 is a front view thereof;

FIG. 3 is a right side view thereof;

FIG. 4 is a rear view thereof;

FIG. 5 is a left side view thereof;

FIG. 6 is a top plan view thereof; and,

FIG. 7 is a bottom plan view thereof.

The broken lines depict environmental subject matter, are for illustrative purposes only and form no part of the claimed design.

1 Claim, 7 Drawing Sheets

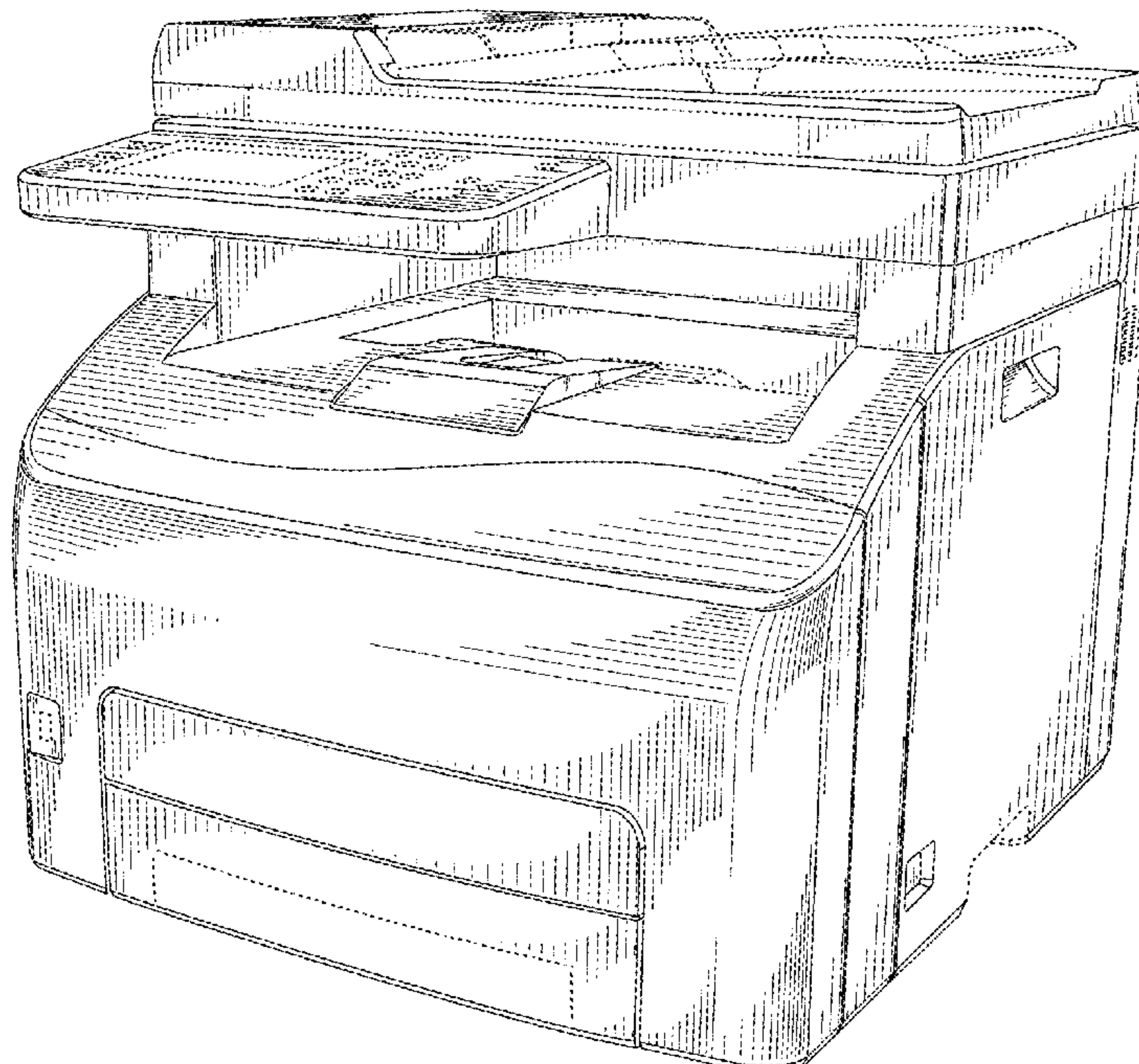

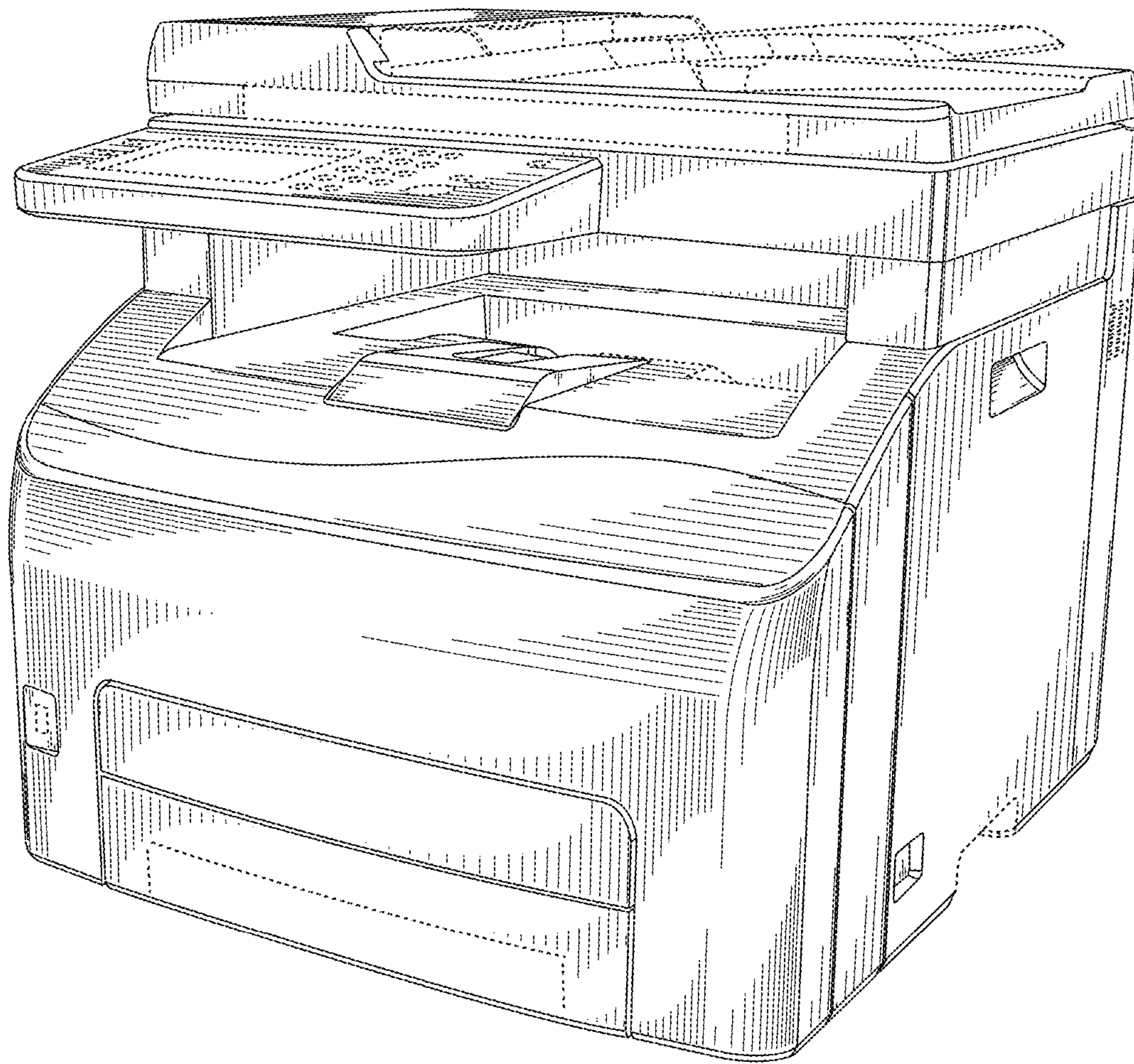

FIG. 1

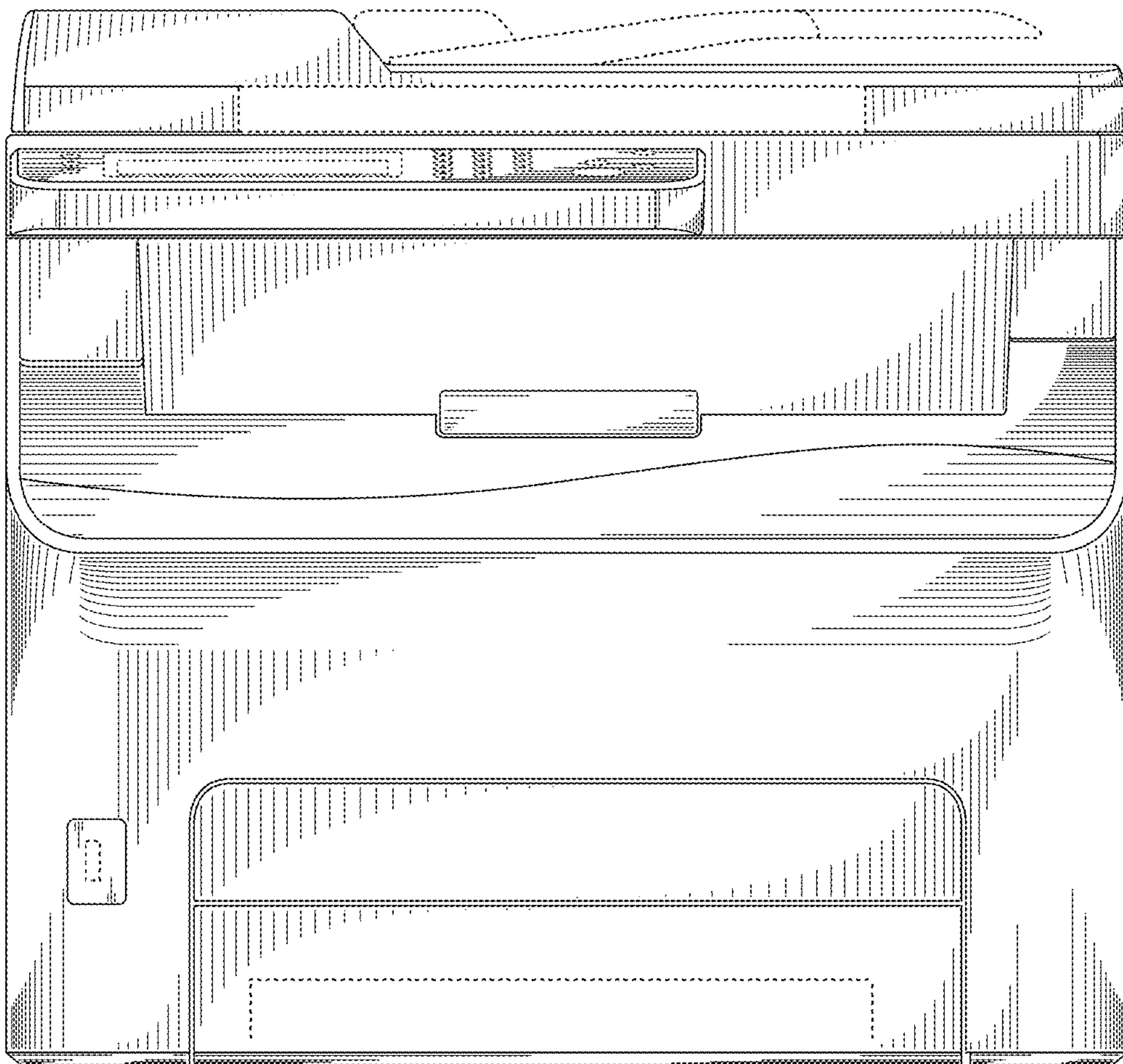

FIG. 2

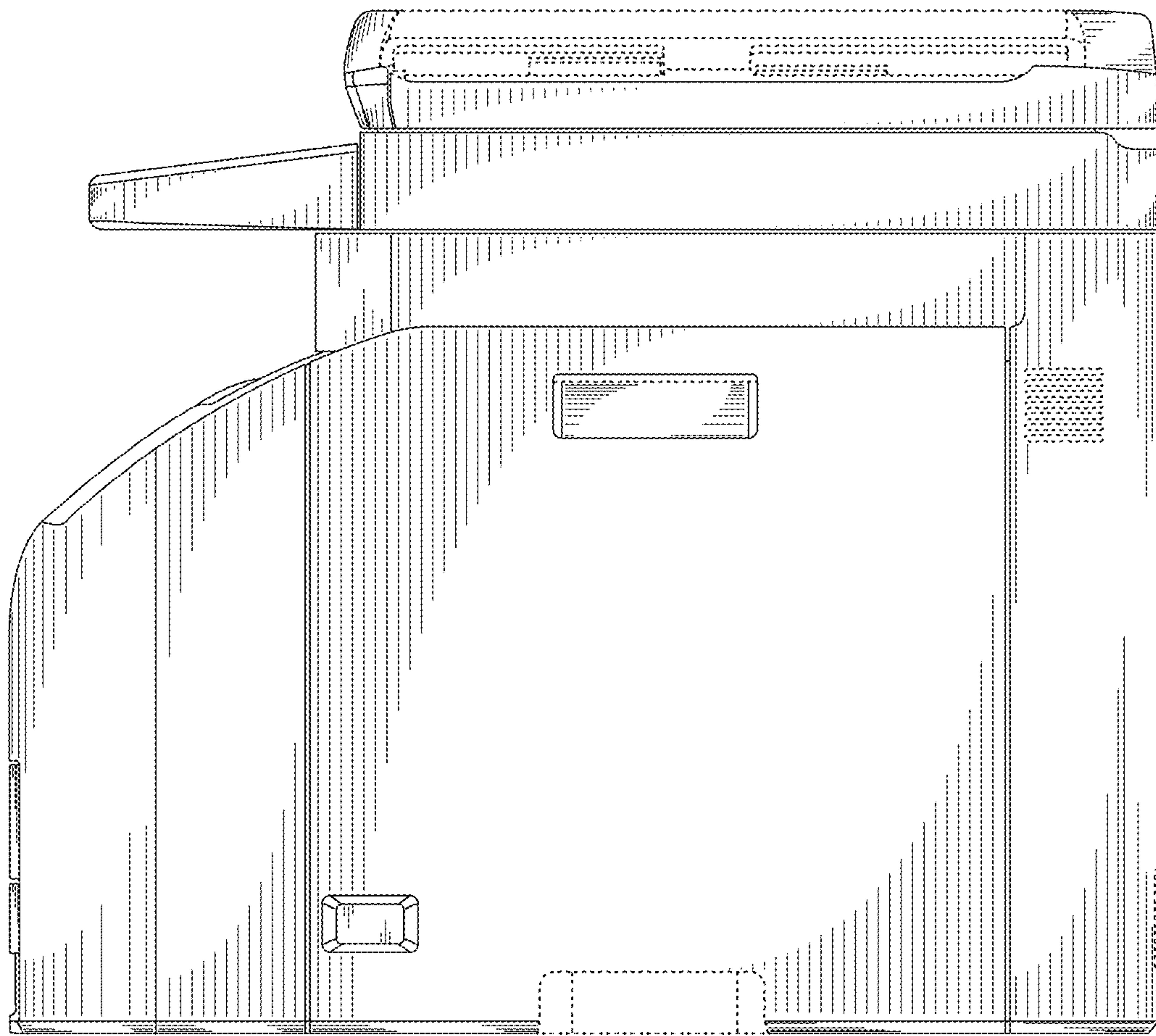

FIG. 3

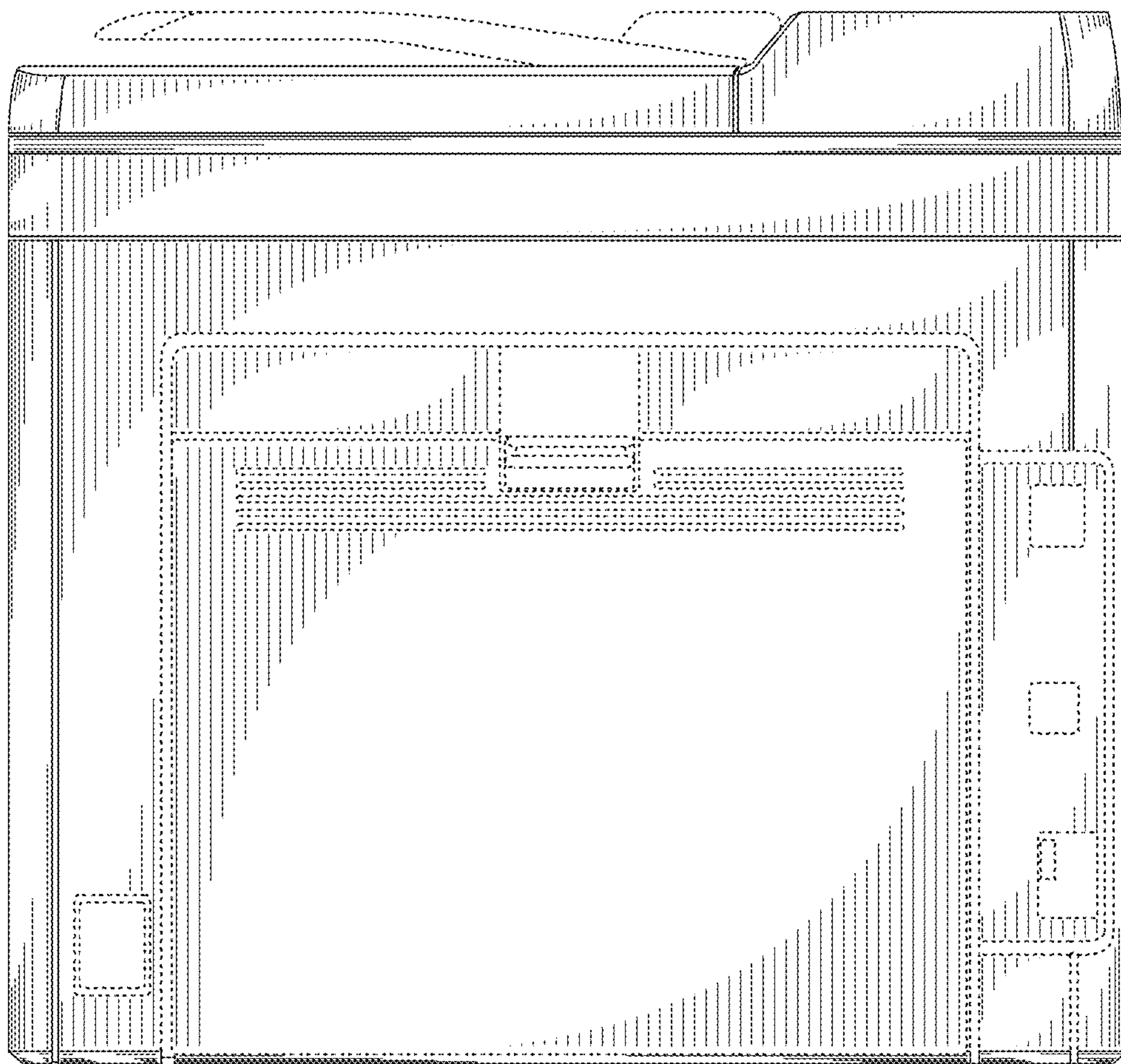

FIG. 4

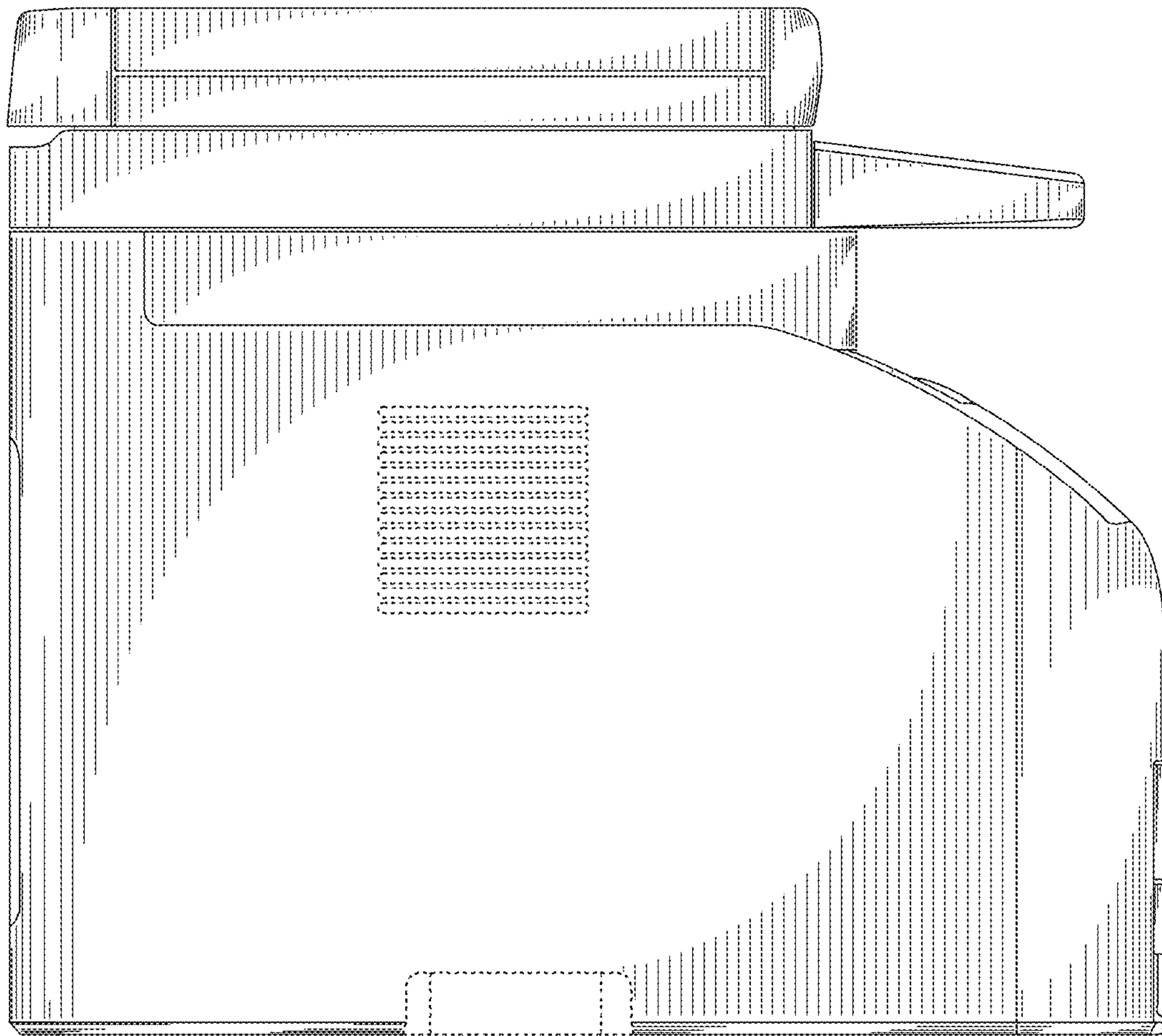

FIG. 5

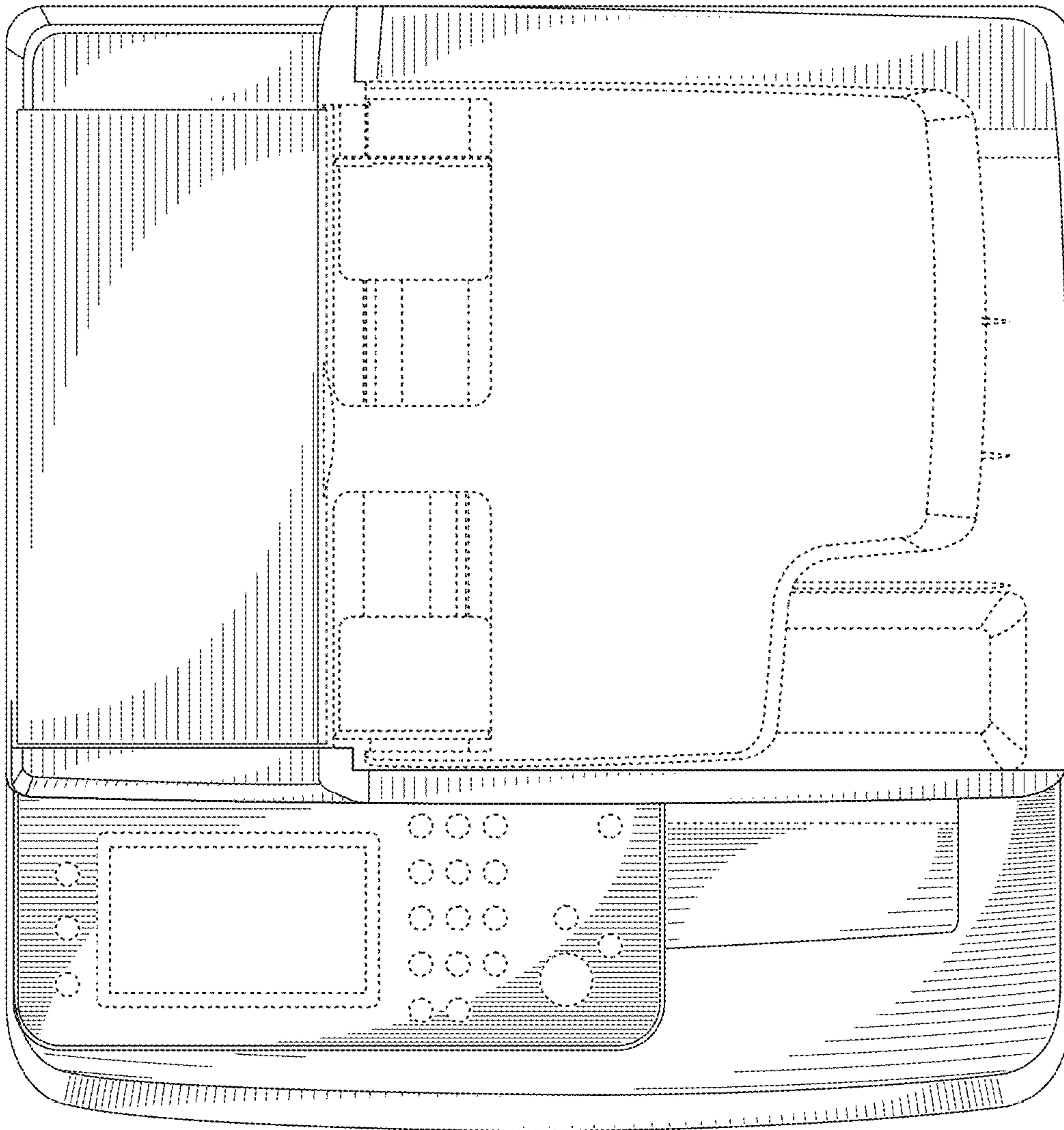

FIG. 6

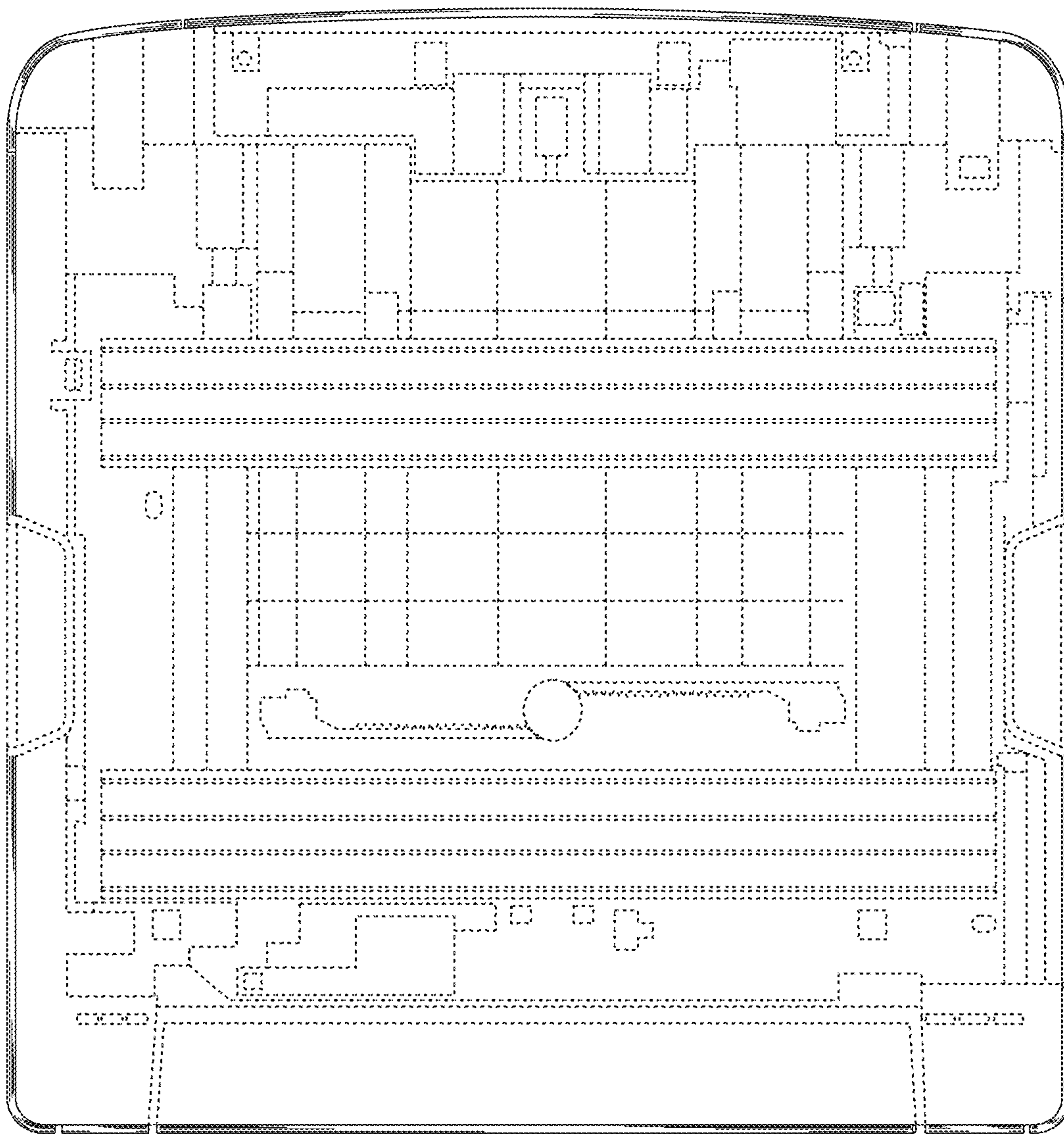

FIG. 7