



US00D769852S

(12) **United States Design Patent**
Godycki et al.

(10) **Patent No.:** **US D769,852 S**

(45) **Date of Patent:** **** Oct. 25, 2016**

(54) **MOBILE COMMUNICATIONS DEVICE CASE**

(71) Applicant: **Q Holdings, LLC**, New York, NY (US)

(72) Inventors: **Przemek Godycki**, Brooklyn, NY (US);
Timothy M. Connelly, Brooklyn, NY (US)

(73) Assignee: **Q Holdings LLC**, New York, NY (US)

(**) Term: **14 Years**

(21) Appl. No.: **29/498,923**

(22) Filed: **Aug. 8, 2014**

Related U.S. Application Data

(62) Division of application No. 29/439,255, filed on Dec. 7, 2012, now Pat. No. Des. 713,395.

(51) **LOC (10) Cl.** **14-03**

(52) **U.S. Cl.**
USPC **D14/250**

(58) **Field of Classification Search**
USPC D14/238.1, 250, 440, 203.3-203.7, 217, D14/240, 248, 251-253, 447, 496; D3/201, D3/218, 247, 269, 273, 301, 303; D13/103, 107-108, 119
CPC A45C 1/06; A45C 11/00; A45C 13/02; A45C 2011/002; A45F 2005/026; A45F 2200/0525; A45F 2200/0516; H04B 1/3888; H04M 1/0283; H04M 1/0202
See application file for complete search history.

(56) **References Cited**

U.S. PATENT DOCUMENTS

D473,563 S * 4/2003 Russell D14/447
6,616,111 B1 * 9/2003 White G06F 1/1626
206/320
D558,773 S * 1/2008 Derry D14/447
D560,068 S * 1/2008 Dixon D3/218

D564,220 S * 3/2008 Dixon D3/218
D592,188 S * 5/2009 Huang D14/217
D637,593 S * 5/2011 Zanetti D14/253
D640,707 S * 6/2011 Yeh D14/447
D669,890 S * 10/2012 Hopkins D14/251
D673,960 S * 1/2013 Lindfield D14/447
D674,804 S * 1/2013 Cote D14/447
D679,693 S * 4/2013 Rashid D14/250
D686,629 S * 7/2013 Trinh D14/447
D691,148 S * 10/2013 Weatherby, III D14/447
D703,657 S * 4/2014 Carnevali D14/253
D713,395 S * 9/2014 Godycki D14/250
D716,044 S * 10/2014 Wilk D3/247
D719,144 S * 12/2014 Eulette D14/250
D750,087 S * 2/2016 Wu D14/447
D751,284 S * 3/2016 Kishimoto D3/218
2010/0294908 A1 * 11/2010 Mish A47B 23/043
248/451
2013/0270850 A1 * 10/2013 Fan A45F 5/00
294/137
2016/0020809 A1 * 1/2016 Joslin H04B 1/3888
455/575.6

* cited by examiner

Primary Examiner — Carla Jobe Wright

(74) *Attorney, Agent, or Firm* — Hard IP LLC

(57) **CLAIM**

The ornamental design for a mobile communications device case, as shown and described.

DESCRIPTION

FIG. 1 is a front/right perspective view of the mobile communications device case of the present invention; FIG. 2 is a rear/left perspective view thereof; FIG. 3 is a front elevational view thereof; FIG. 4 is a rear elevational view thereof; FIG. 5 is a right elevational view thereof; FIG. 6 is a left elevational view thereof; FIG. 7 is a top plan view thereof; and, FIG. 8 is a bottom plan view thereof. The broken lines depict portions of the mobile communications device case that form no part of the claimed design.

1 Claim, 3 Drawing Sheets

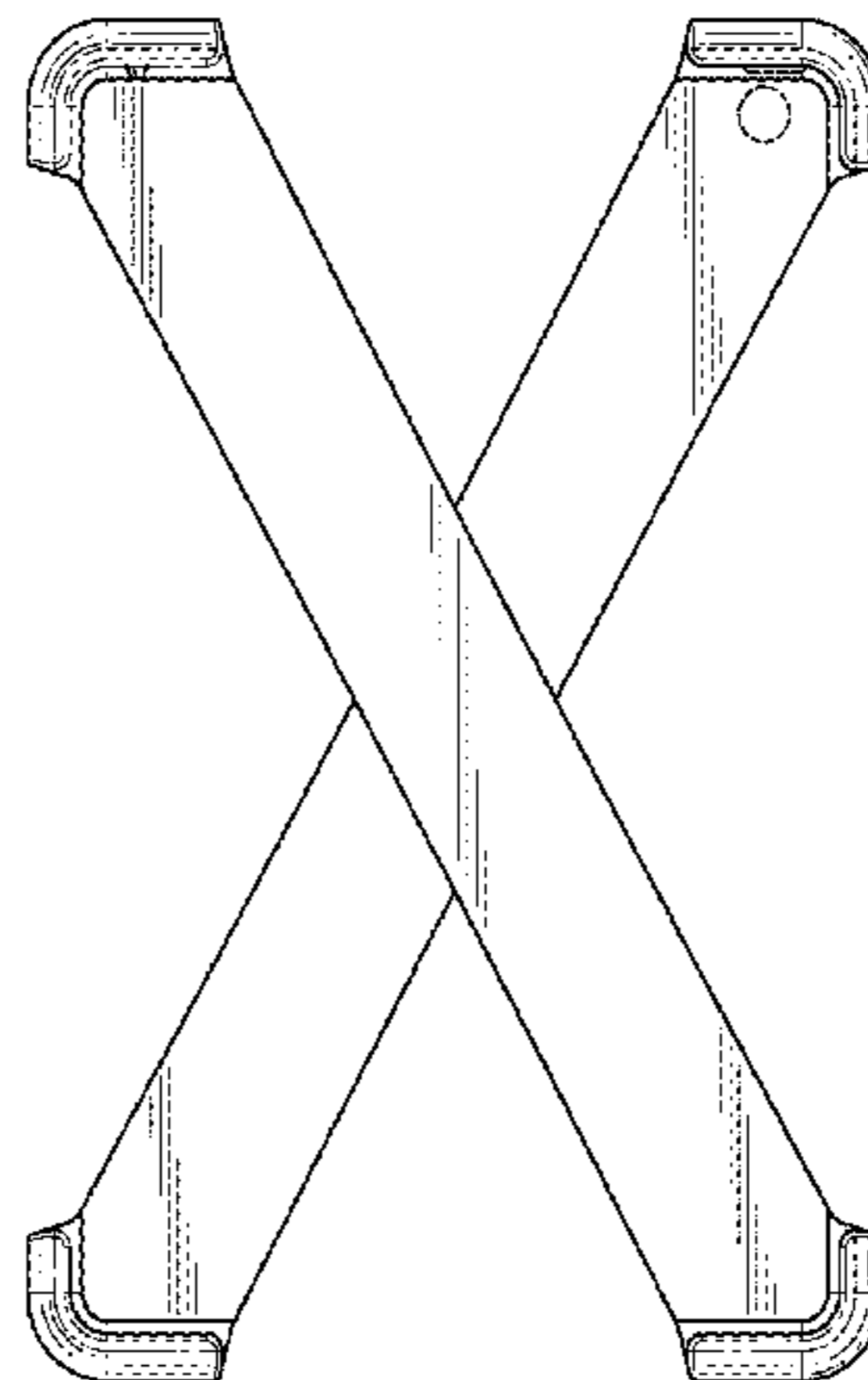
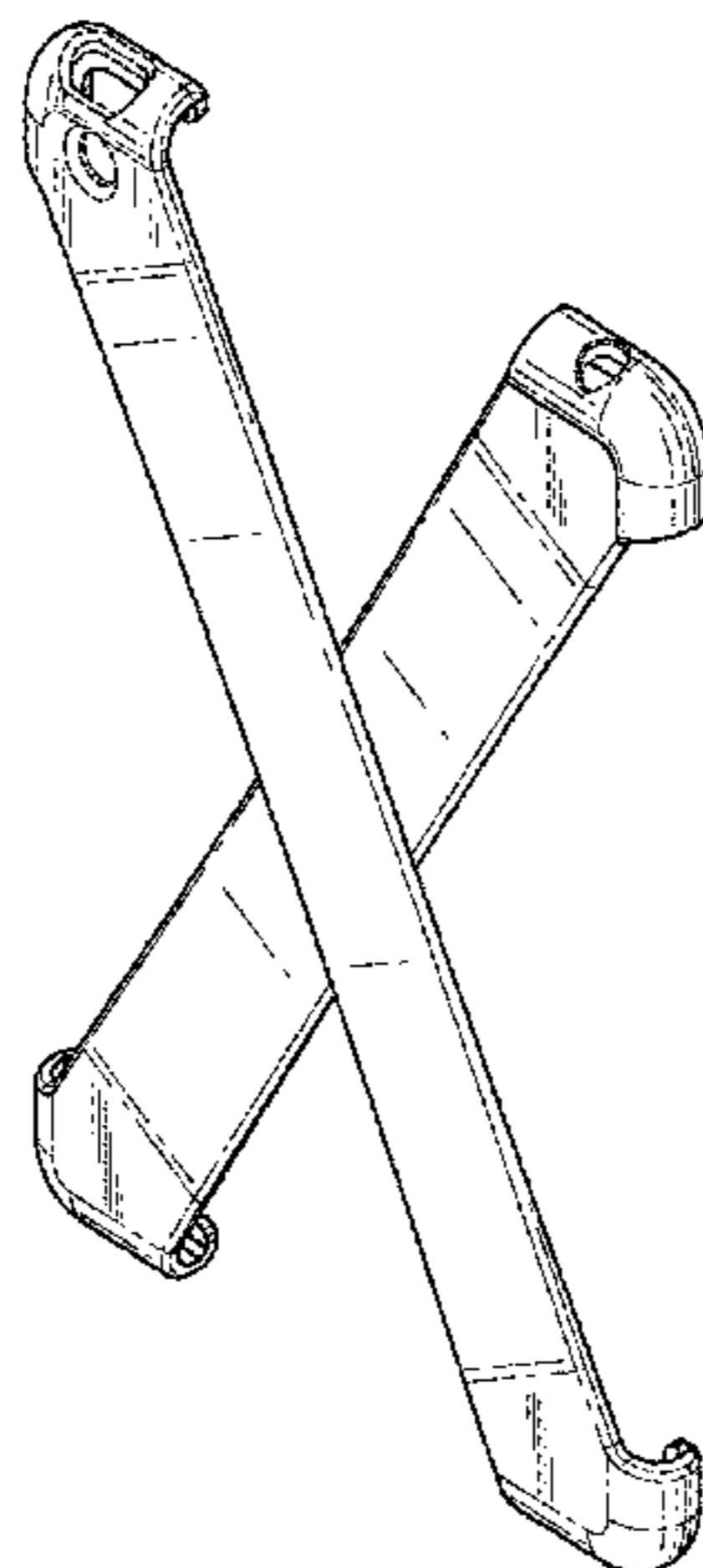

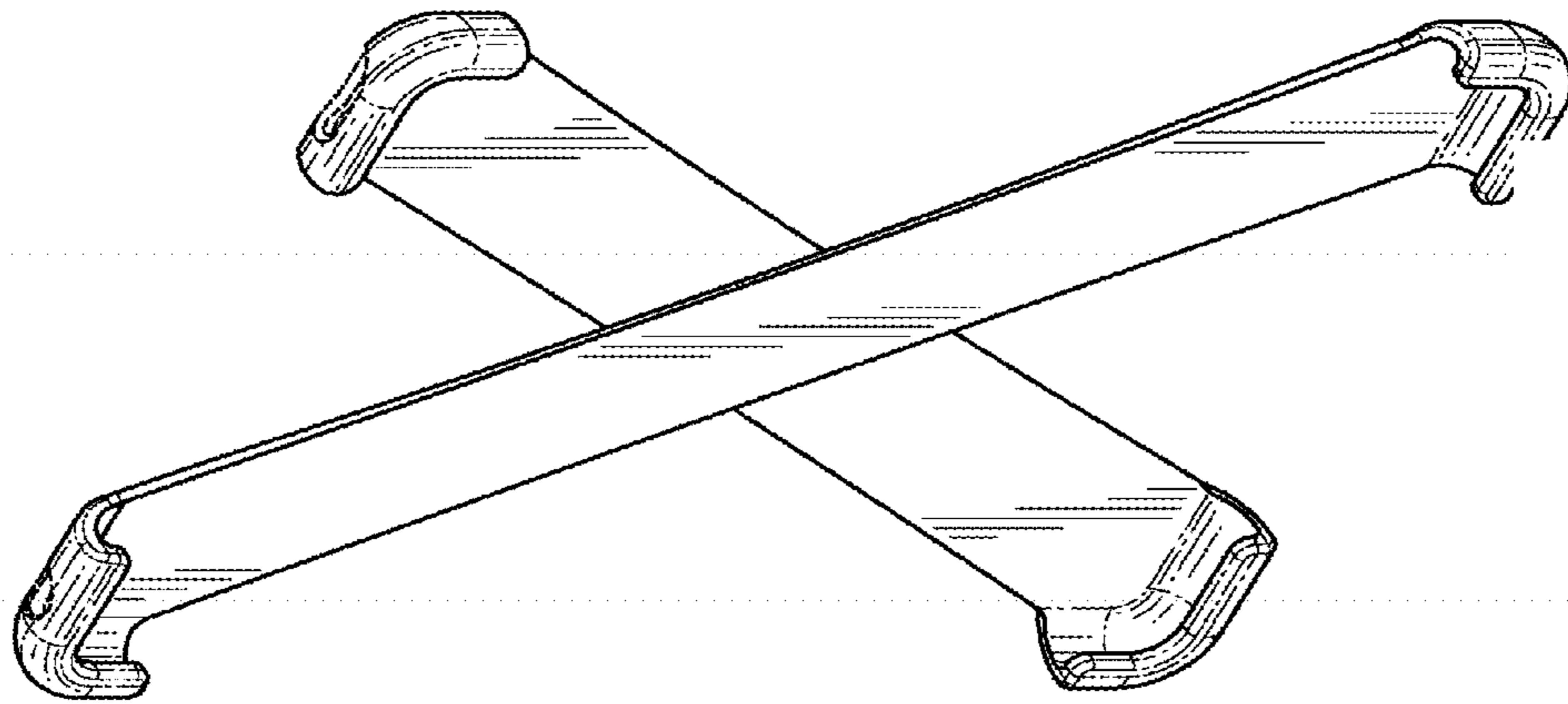

FIG. 2

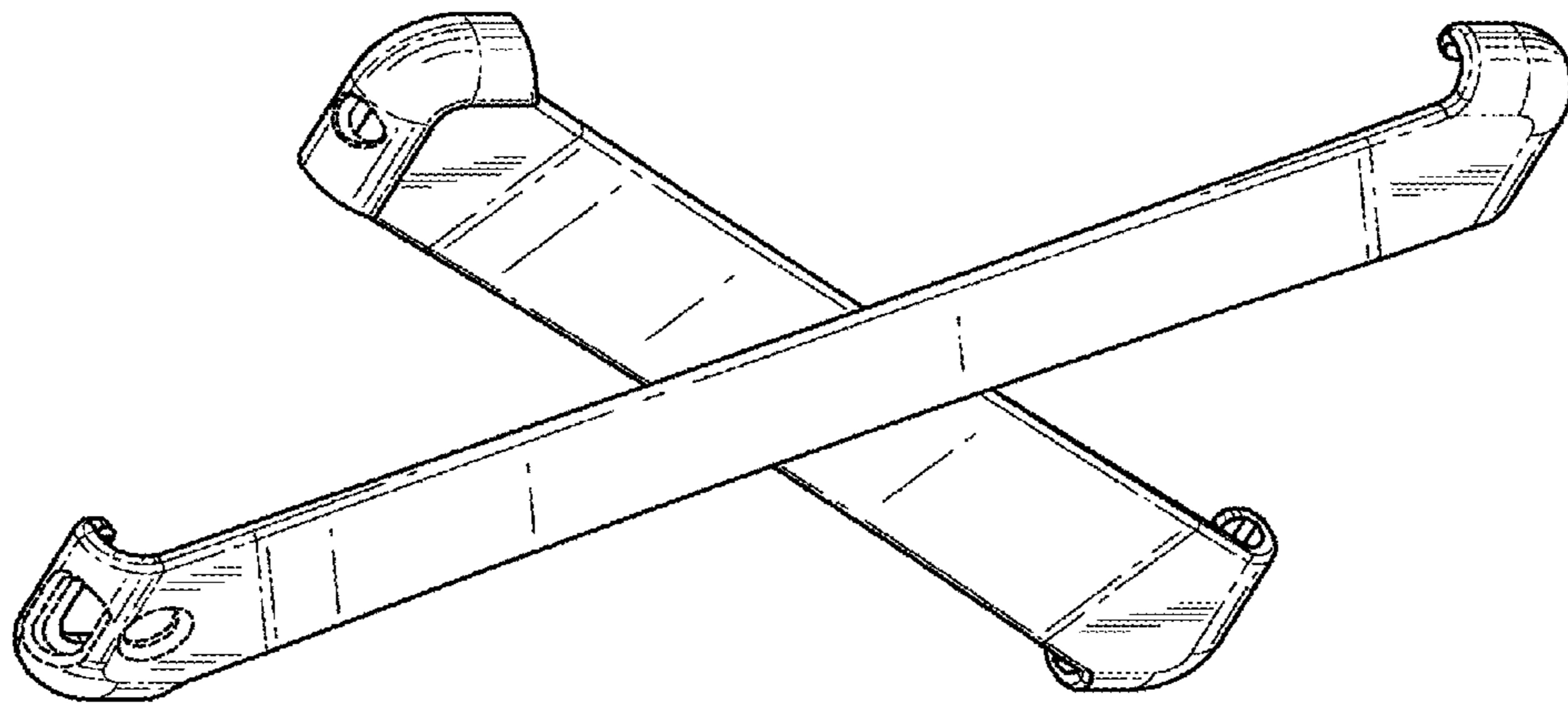

FIG. 1

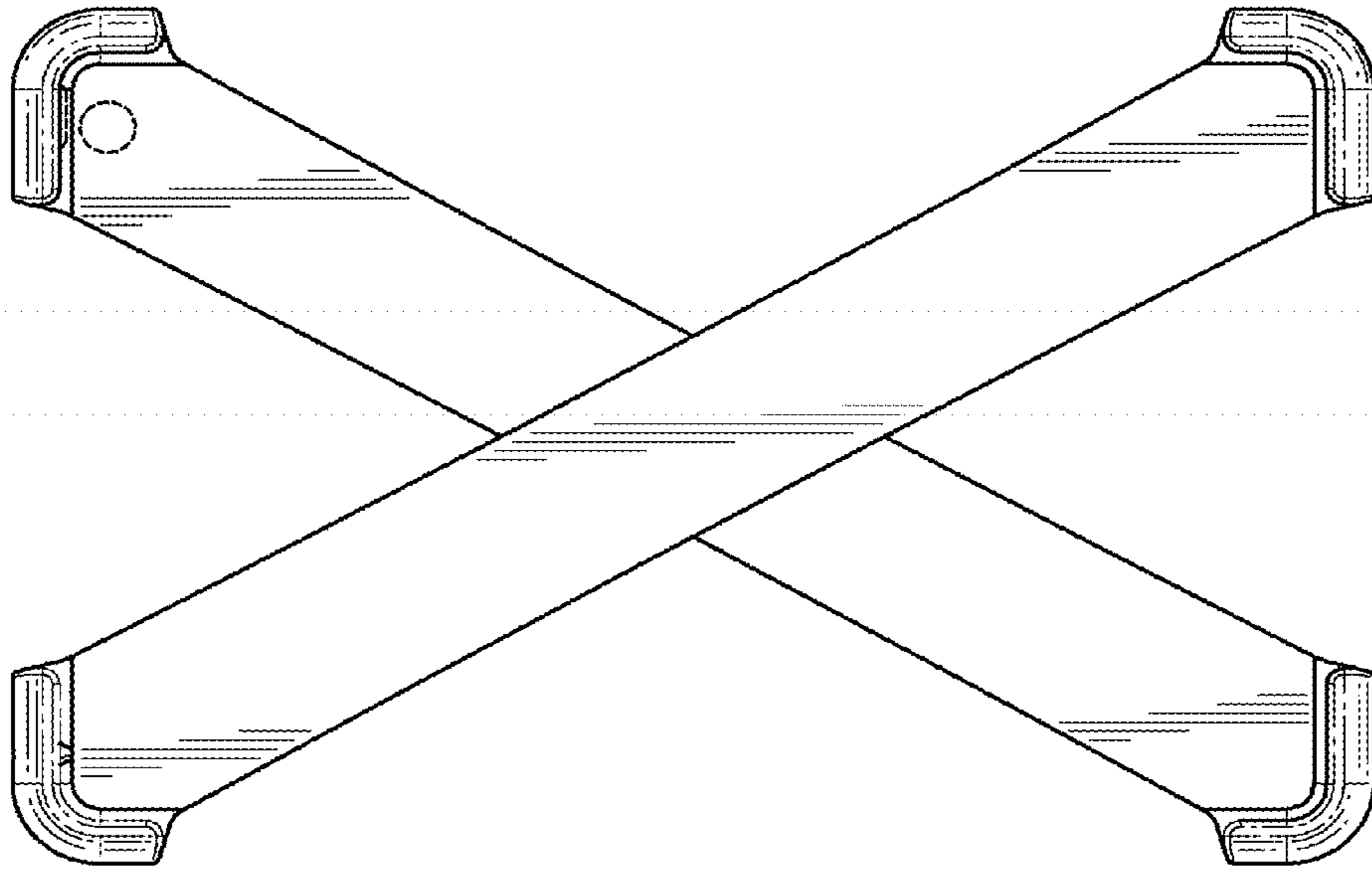

FIG. 4

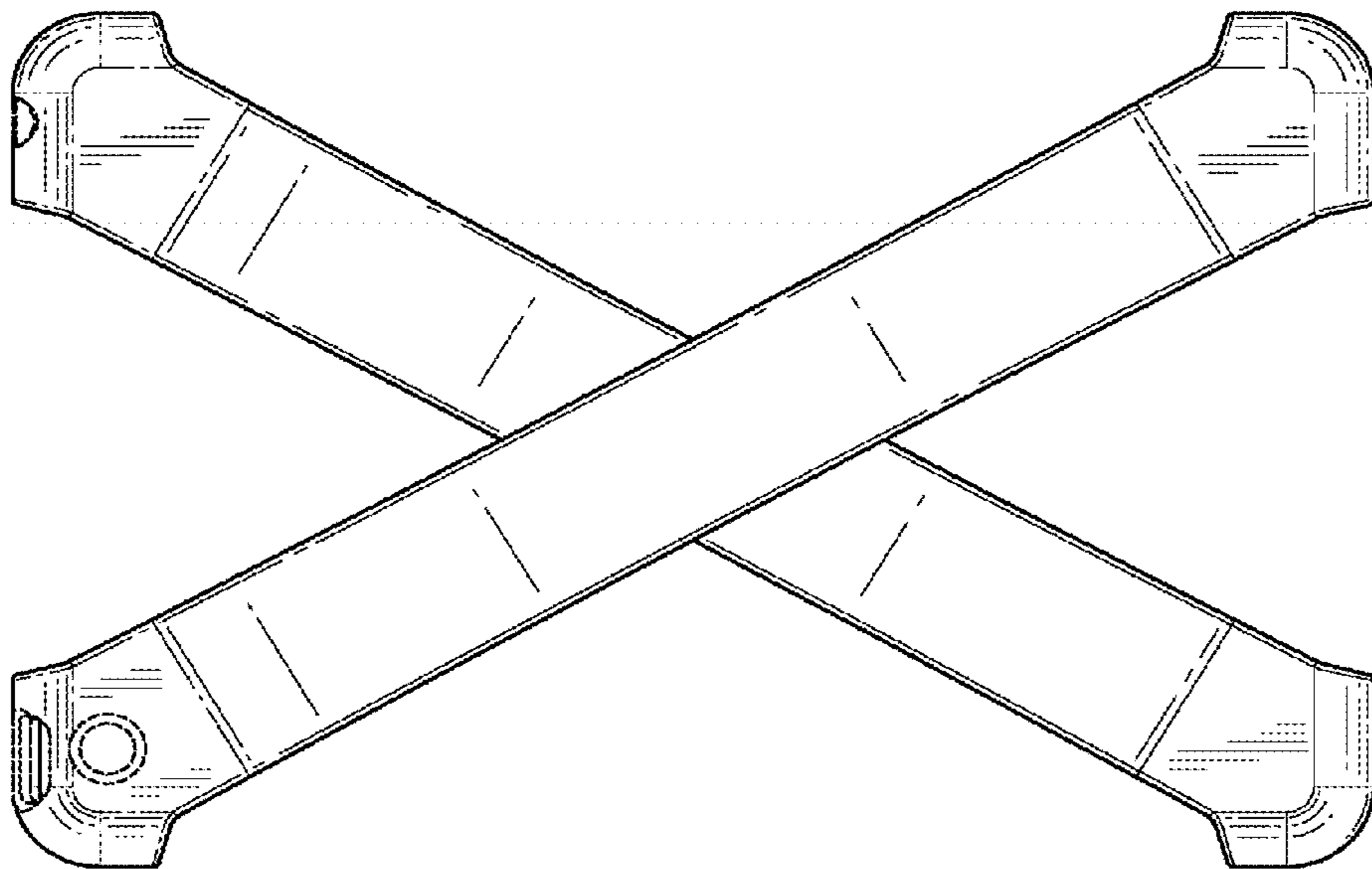

FIG. 3

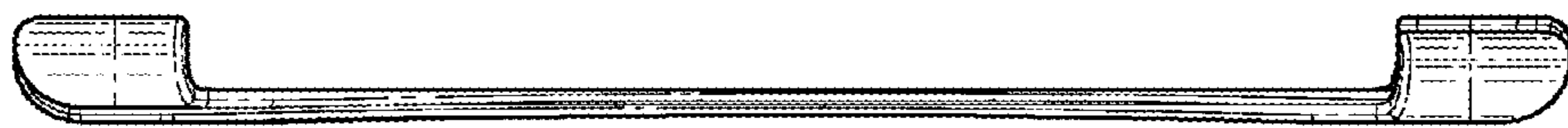

FIG. 5



FIG. 6

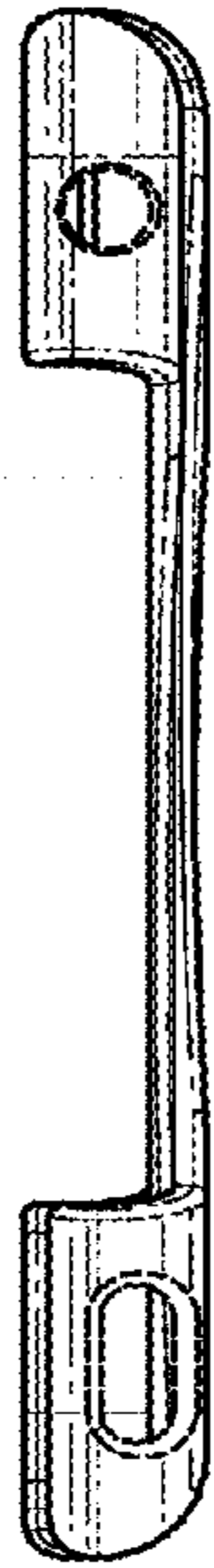

FIG. 7

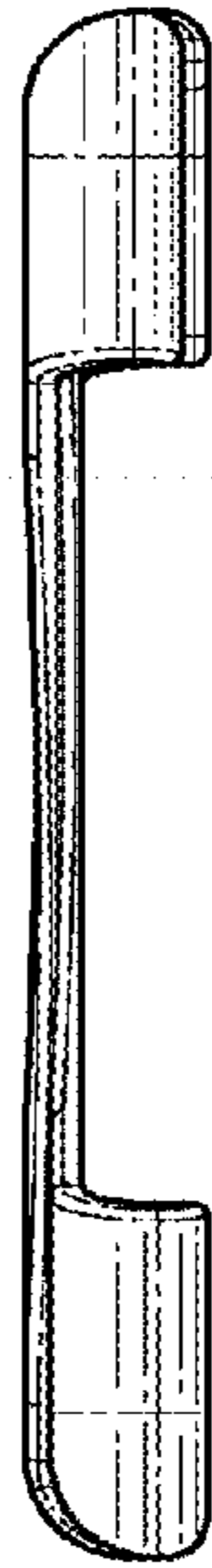

FIG. 8

UNITED STATES PATENT AND TRADEMARK OFFICE
CERTIFICATE OF CORRECTION

PATENT NO. : D769,852 S
APPLICATION NO. : 29/498923
DATED : October 25, 2016
INVENTOR(S) : Przemek Godycki et al.

Page 1 of 2

It is certified that error appears in the above-identified patent and that said Letters Patent is hereby corrected as shown below:

On the Title Page

Item (71), the name of the applicant "Q Holdings, LLC" should read --Q Holdings LLC--

In the Drawings

Please replace FIG. 2 with FIG. 2 as shown on the attached page.

Signed and Sealed this
Twentieth Day of December, 2016



Michelle K. Lee
Director of the United States Patent and Trademark Office

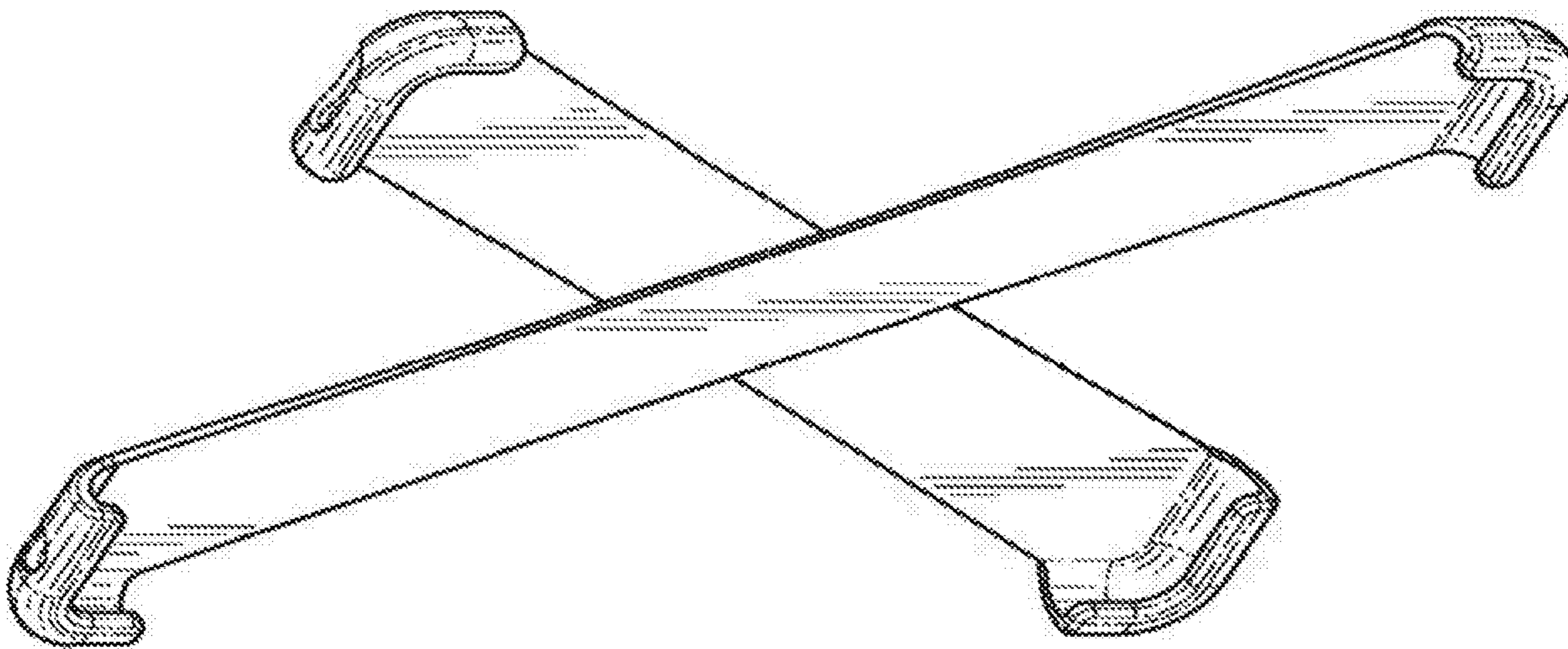

FIG. 2