



US00D769844S

(12) **United States Design Patent**
Pineau

(10) **Patent No.:** **US D769,844 S**

(45) **Date of Patent:** **** Oct. 25, 2016**

(54) **SPEAKER BOX**

H04R 2499/11; H04R 2499/13; H04R
2499/15; H04S 3/00; H04S 7/30

(71) Applicant: **FOCAL JMLAB**, La Talaudiere (FR)

See application file for complete search history.

(72) Inventor: **Alain Pineau**, Vitry-sur-Seine (FR)

(56) **References Cited**

(73) Assignee: **FOCAL JMLAB**, La Talaudiere (FR)

U.S. PATENT DOCUMENTS

(**) Term: **15 Years**

D362,667 S *	9/1995	Sohn	D14/214
D368,710 S *	4/1996	Althans	D14/128
D607,878 S *	1/2010	Murray	D14/216
D612,837 S *	3/2010	Murray	D14/216
D639,774 S *	6/2011	Rader	D14/204
D687,015 S *	7/2013	Paddock	D14/215
D723,518 S *	3/2015	Moon	D14/215

(21) Appl. No.: **29/530,775**

(22) Filed: **Jun. 19, 2015**

* cited by examiner

(30) **Foreign Application Priority Data**

Jan. 12, 2015 (EM) 2612085-0001

(51) **LOC (10) Cl.** **14-03**

(52) **U.S. Cl.**
USPC **D14/215**

(58) **Field of Classification Search**
USPC D14/167, 168, 170-172, 188, 194-196,
D14/204, 207, 209.1, 210-216, 219, 221,
D14/222, 224, 239, 496; 181/143, 144, 147,
181/148, 150, 153, 157, 198, 199;
381/300-303, 306, 332, 333, 336, 345,
381/361-364, 386-388; 369/6-12

CPC ... B60R 11/0217; G06F 1/1688; G10K 9/22;
G10K 11/004; H03F 1/327; H04M 1/03;
H04M 1/035; H04N 5/342; H04N 21/4852;
H04R 1/02; H04R 1/06; H04R 1/021; H04R
1/025; H04R 1/026; H04R 1/028; H04R
1/105; H04R 1/323; H04R 1/403; H04R
1/2803; H04R 1/2834; H04R 5/02; H04R
7/20; H04R 9/06; H04R 9/025; H04R
2201/021; H04R 2400/00; H04R 2400/07;

Primary Examiner — Keli L Hill

(74) *Attorney, Agent, or Firm* — Burr & Brown, PLLC

(57) **CLAIM**

The ornamental design for a speaker box, as shown and described.

DESCRIPTION

FIG. 1 is a perspective view of a speaker box illustrating my new design;

FIG. 2 is a front view thereof;

FIG. 3 is a rear view thereof;

FIG. 4 is a right side view thereof;

FIG. 5 is a left side view thereof;

FIG. 6 is a top view thereof; and,

FIG. 7 is a bottom view thereof.

The broken lines shown are included for the purpose of illustrating portions of the speaker box that form no part of the claim.

1 Claim, 7 Drawing Sheets

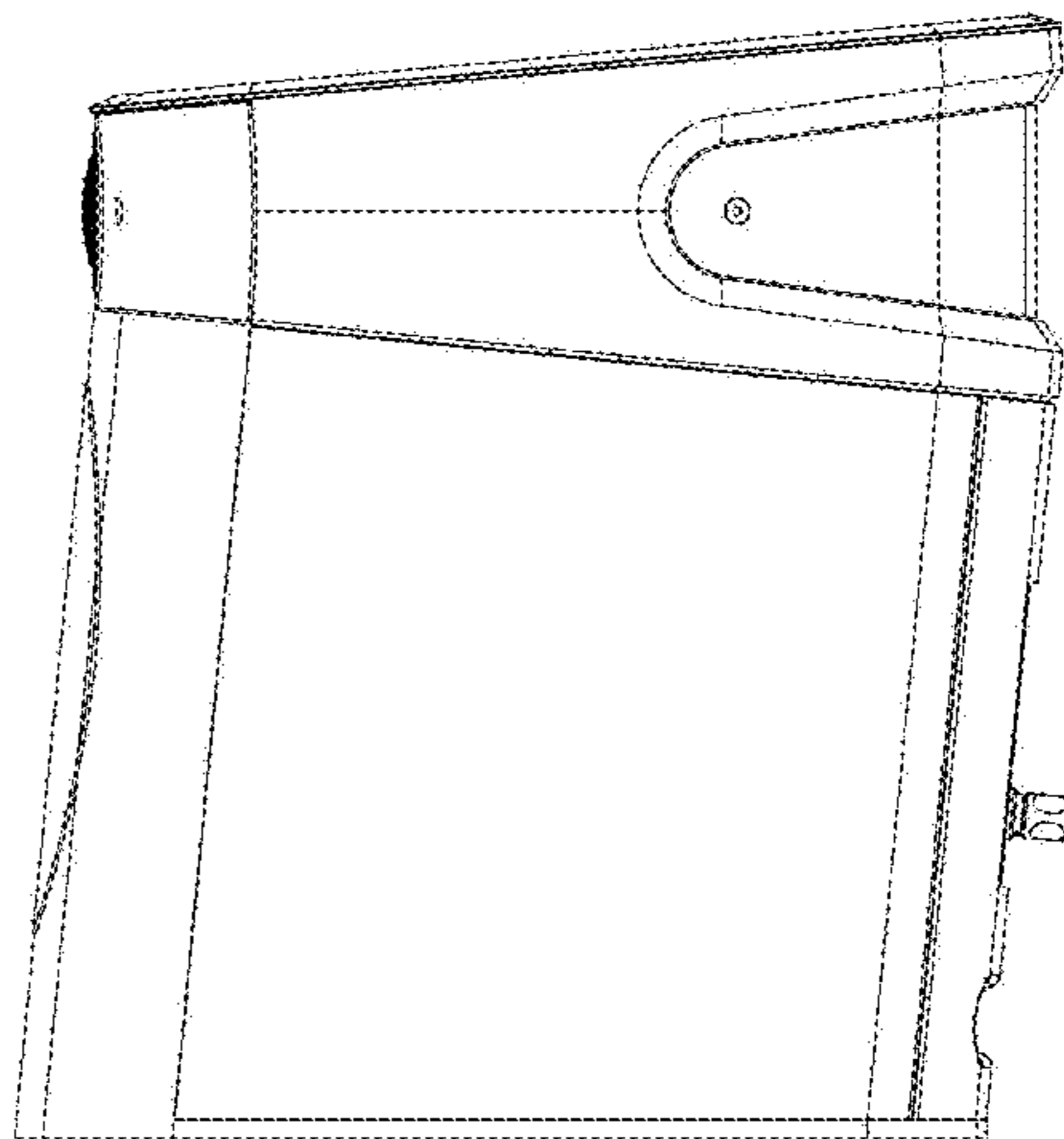
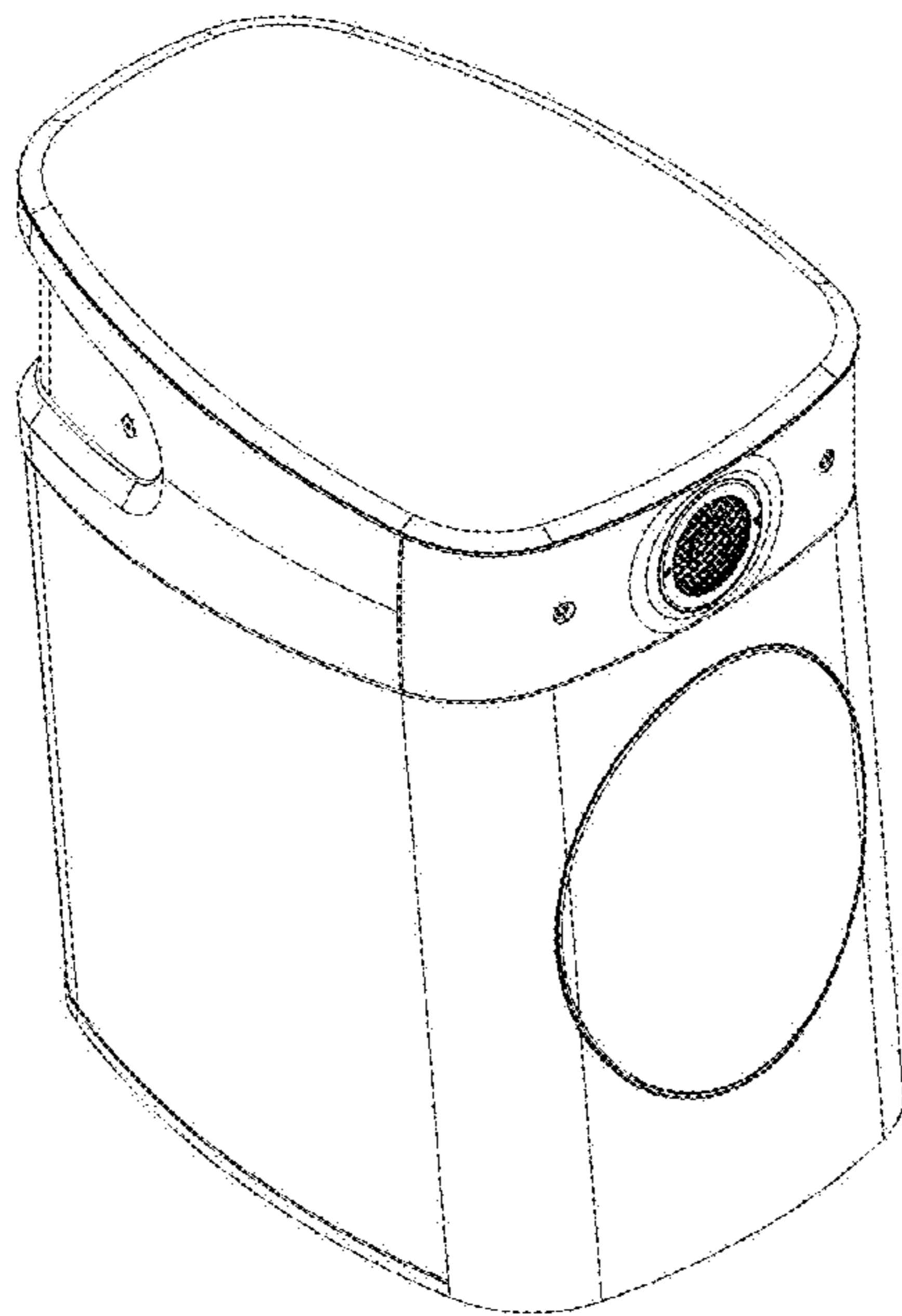

FIG. 1

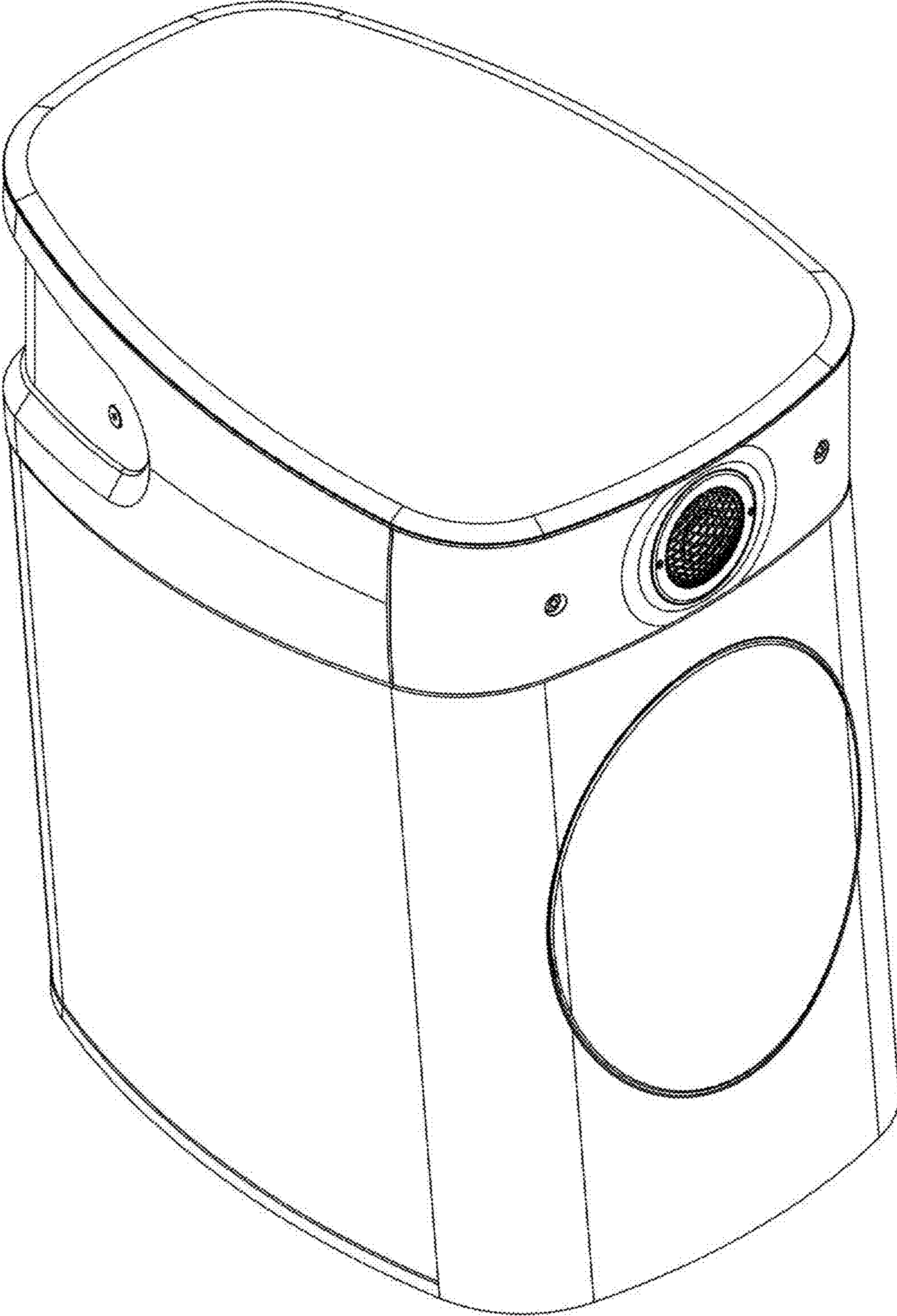

FIG. 2

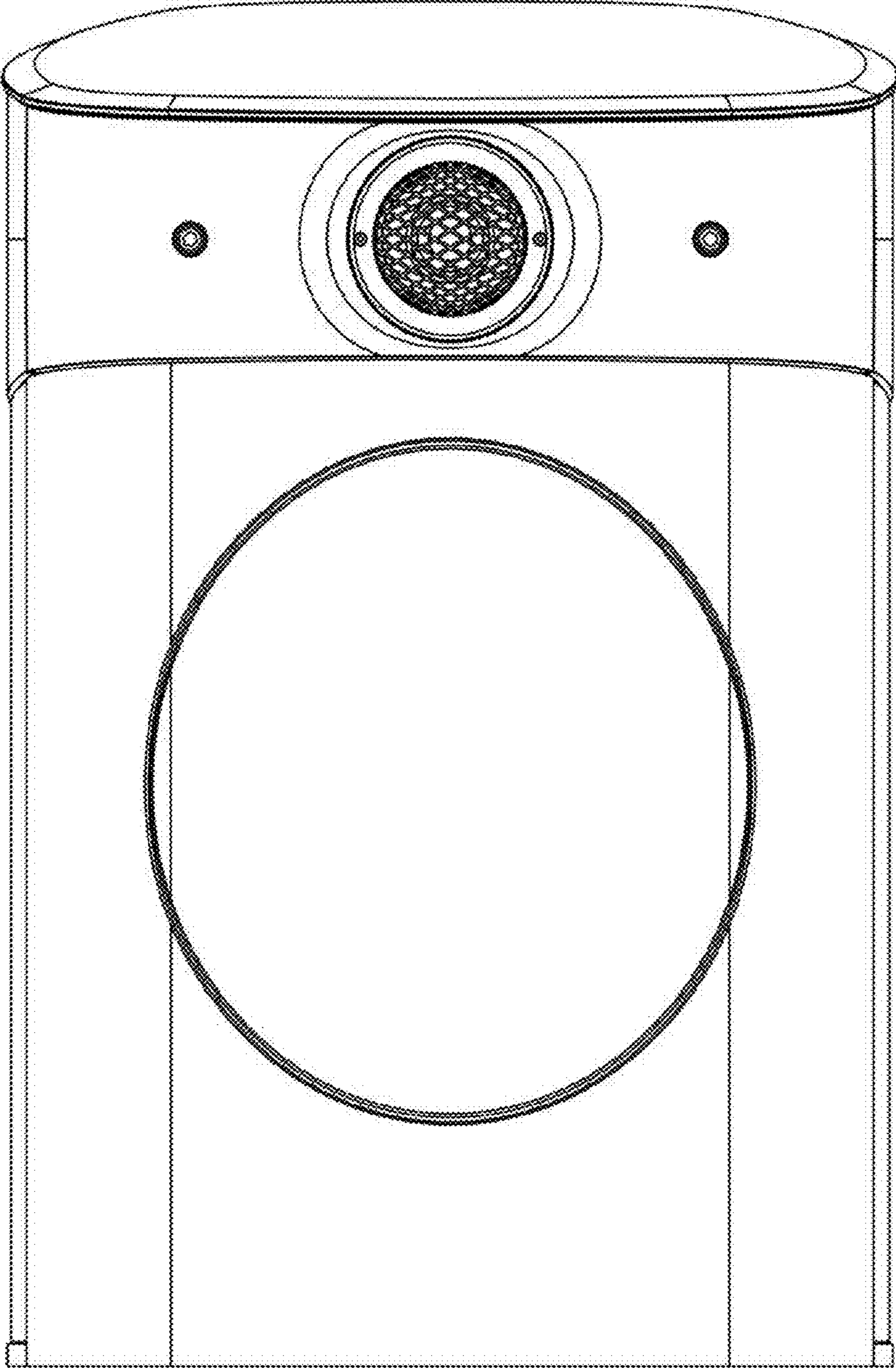

FIG. 3

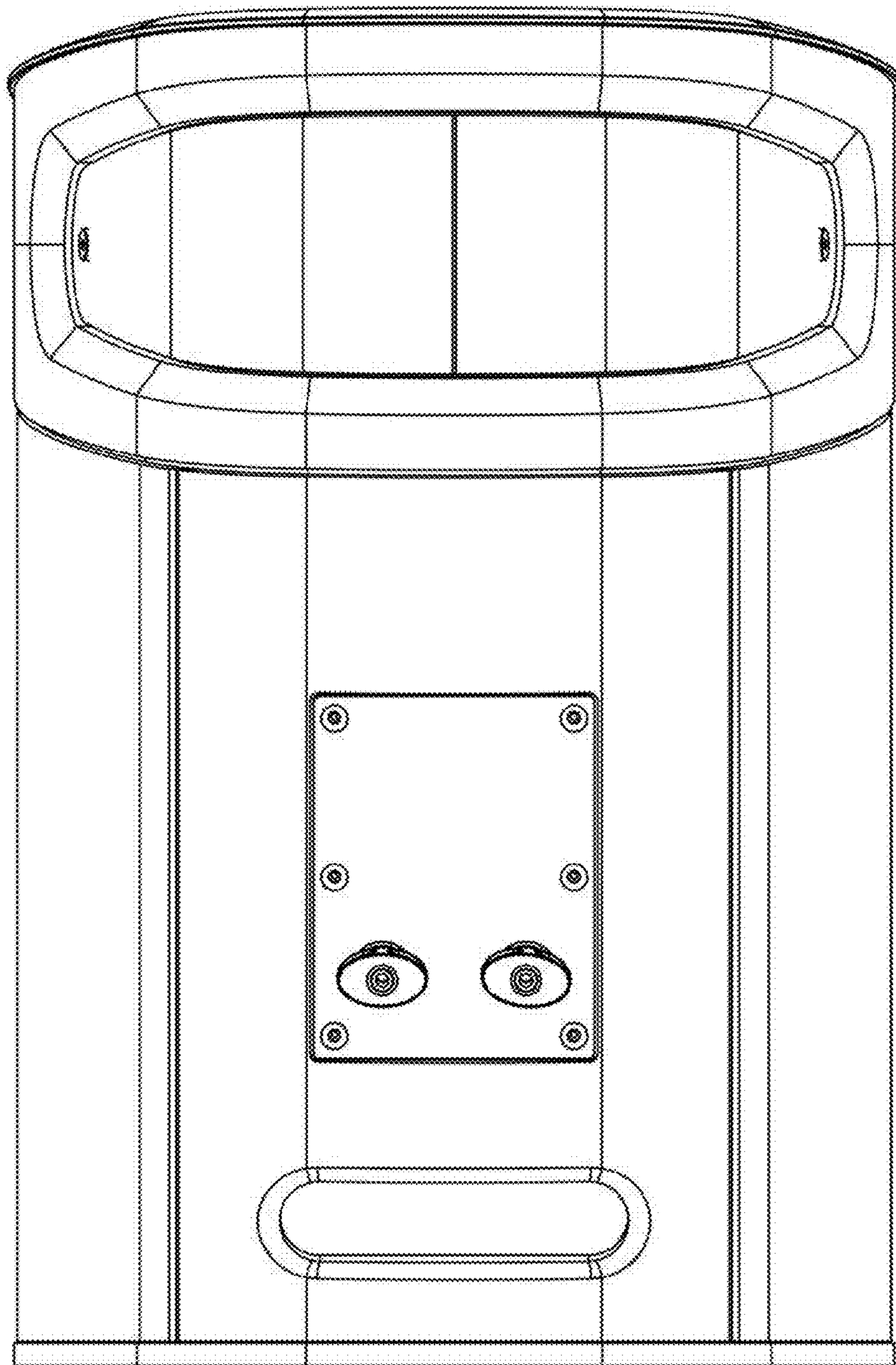

FIG. 4

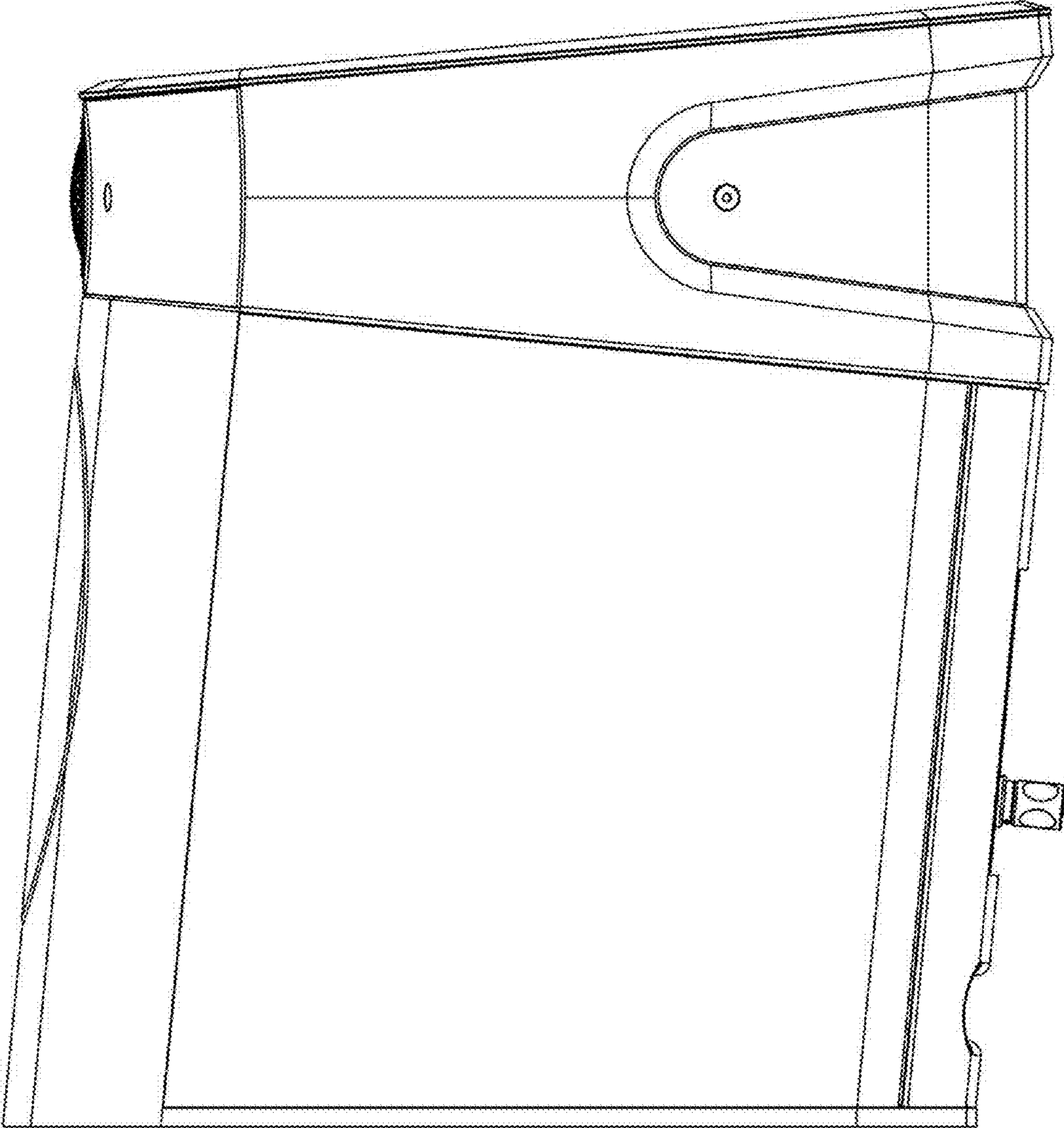

FIG. 5

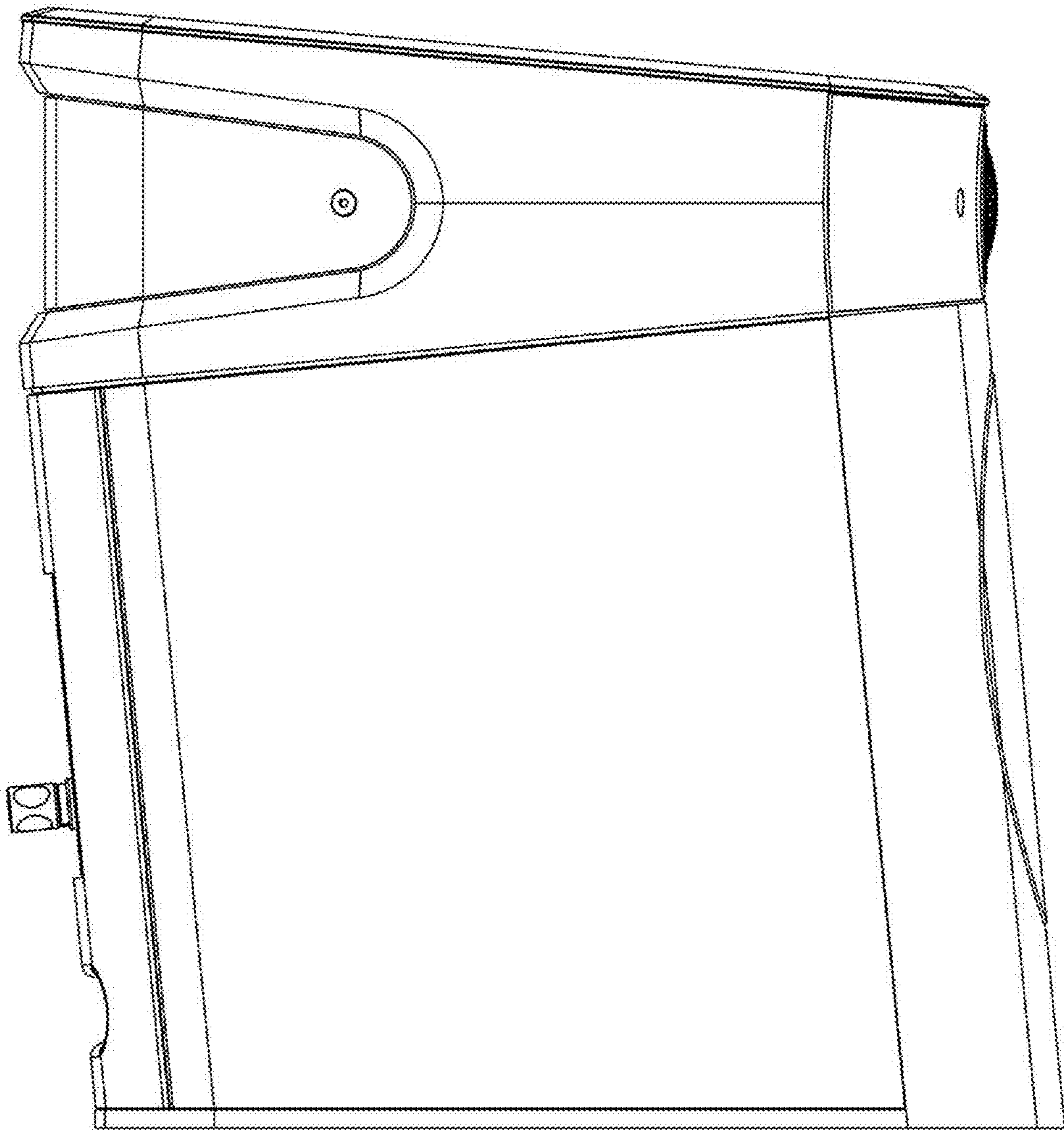

FIG. 6

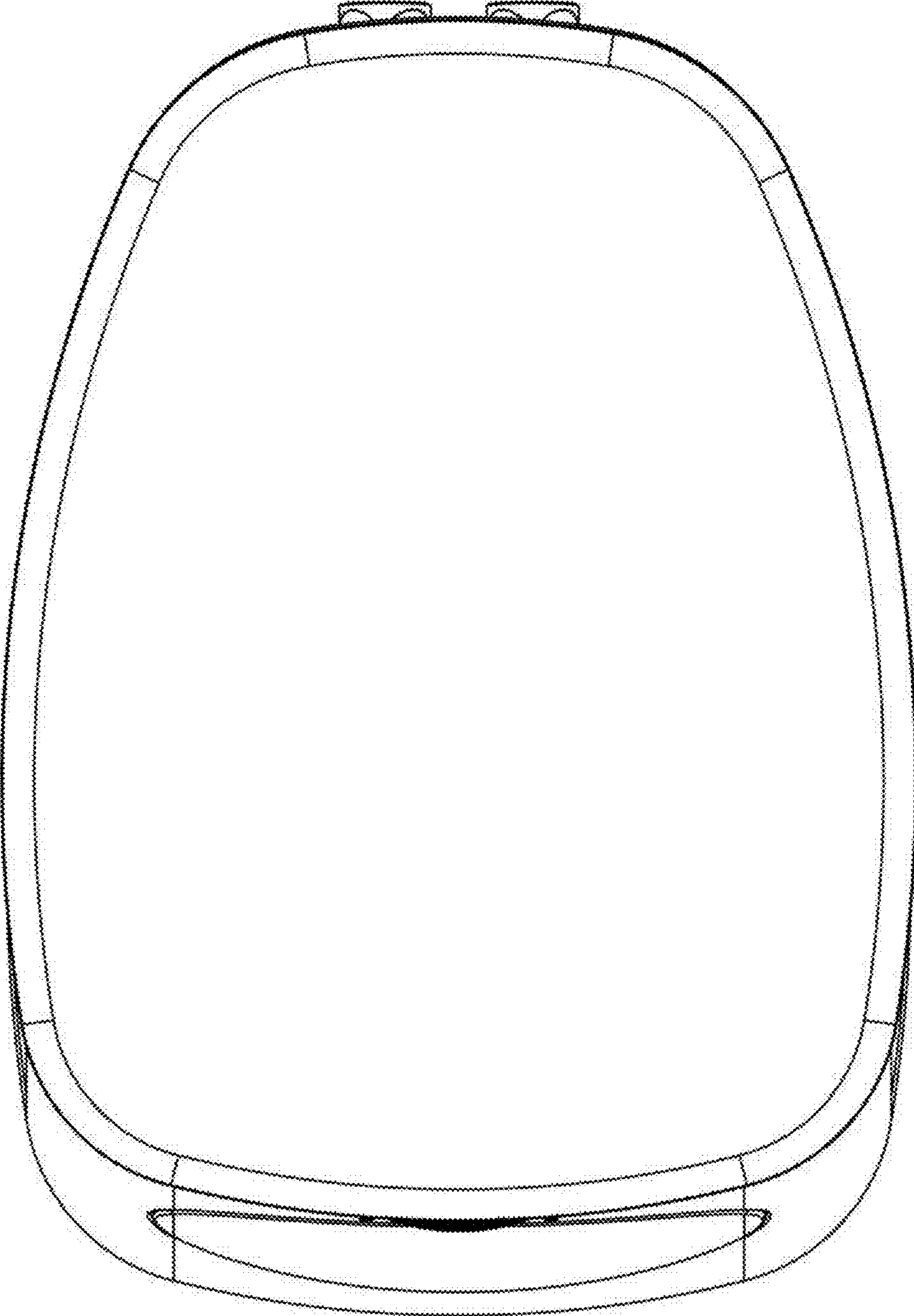

FIG. 7

