



US00D769659S

(12) **United States Design Patent** (10) **Patent No.:** **US D769,659 S**
Su (45) **Date of Patent:** **** Oct. 25, 2016**

(54) **CHAIR BACKREST**

D643,652 S * 8/2011 Piretti D6/379
D643,653 S * 8/2011 Piretti D6/380
D761,049 S * 7/2016 Pan D6/716.4
D761,050 S * 7/2016 Pan D6/716.4

(71) Applicant: **Shu O Su**, Tainan (TW)

(72) Inventor: **Shu O Su**, Tainan (TW)

* cited by examiner

(**) Term: **15 Years**

Primary Examiner — Mimoso De

(21) Appl. No.: **29/544,034**

(74) *Attorney, Agent, or Firm* — Raymond Y. Chan;
David and Raymond Patent Firm

(22) Filed: **Oct. 29, 2015**

(51) **LOC (10) Cl.** **06-01**

(57) **CLAIM**

(52) **U.S. Cl.**

The ornamental design for a chair backrest, as shown and described.

USPC **D6/716.4; D6/373**

(58) **Field of Classification Search**

USPC D6/334-336, 366, 371, 372, 373, 374,
D6/376, 379, 380, 716, 716.1, 716.2,
D6/716.3, 716.4

CPC A47C 3/04; A47C 4/02; A47C 4/03;
A47C 5/04; A47C 7/022; A47C 7/16; A47C
7/40

See application file for complete search history.

DESCRIPTION

FIG. 1 is a front perspective view of chair backrest showing my new design.

FIG. 2 is a front view thereof.

FIG. 3 is a rear view thereof.

FIG. 4 is a left view thereof.

FIG. 5 is a right view thereof.

FIG. 6 is a top view thereof.

FIG. 7 is a bottom view thereof.

FIG. 8 is a perspective view of the chair backrest showing my new design connected to a support unit, wherein the broken lines in the drawing is for illustrative purpose only and shows the portion that forms no part of the design to be claimed; and,

FIG. 9 is a rear perspective view thereof.

(56) **References Cited**

U.S. PATENT DOCUMENTS

D569,644 S * 5/2008 Kumazawa D6/372
D574,646 S * 8/2008 Su D6/373
D595,072 S * 6/2009 Su D6/716.4
D595,520 S * 7/2009 Su D6/716.4
D600,465 S * 9/2009 Kumazawa D6/373
D609,488 S * 2/2010 Kumazawa D6/373
D637,838 S * 5/2011 Piretti D6/379
D637,839 S * 5/2011 Piretti D6/716
D638,641 S * 5/2011 Piretti D6/716

1 Claim, 7 Drawing Sheets

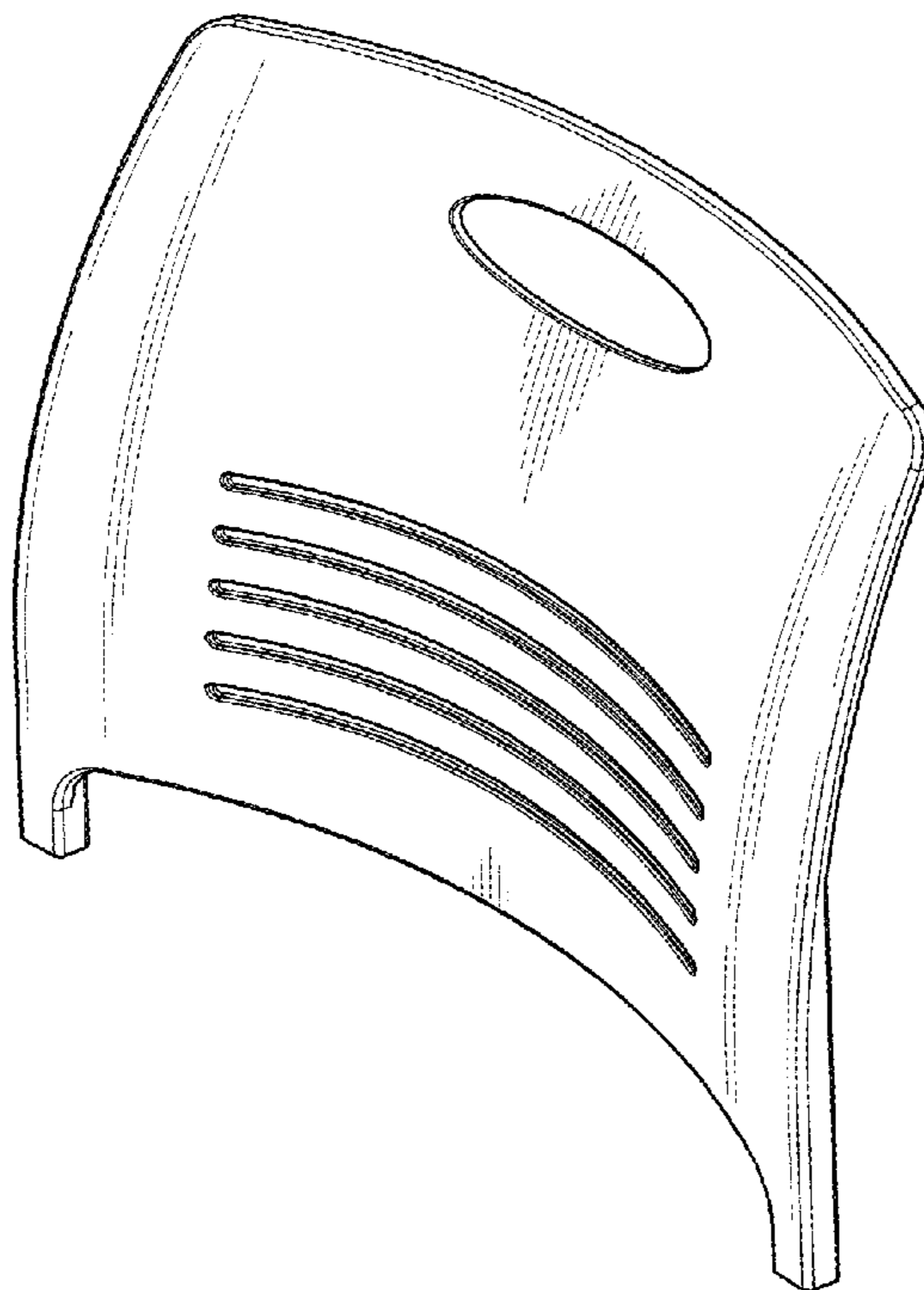

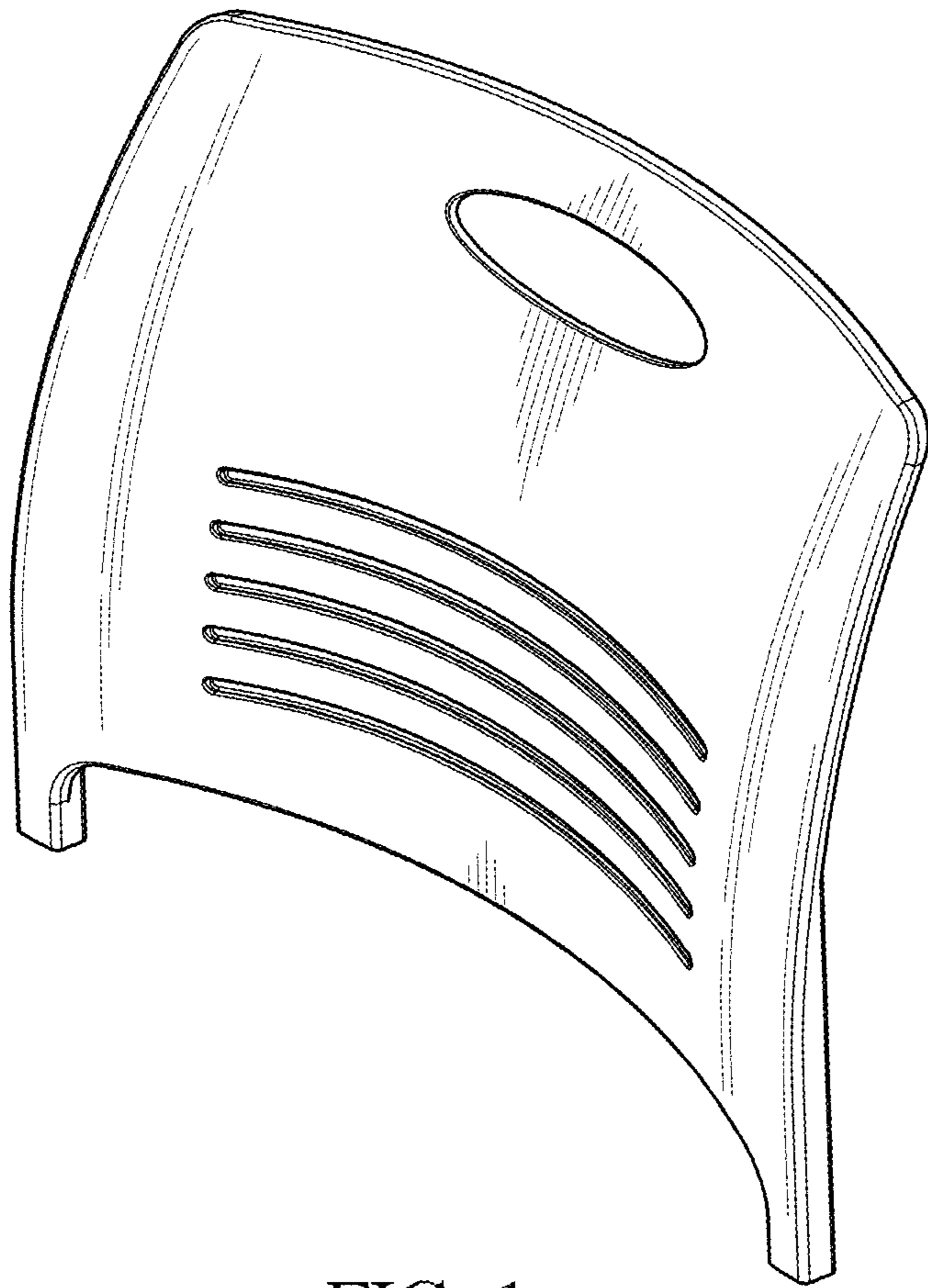

FIG. 1

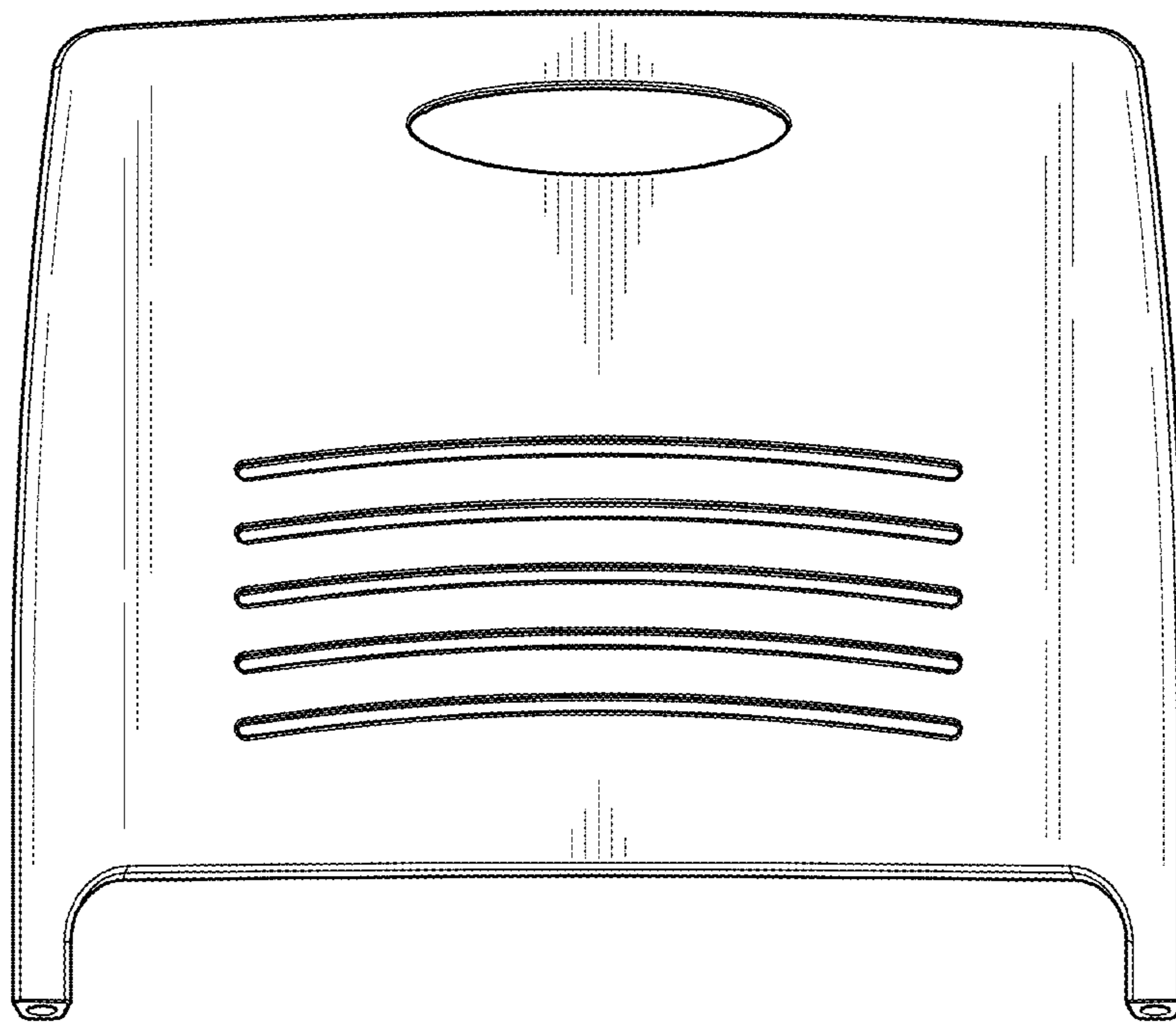

FIG. 2

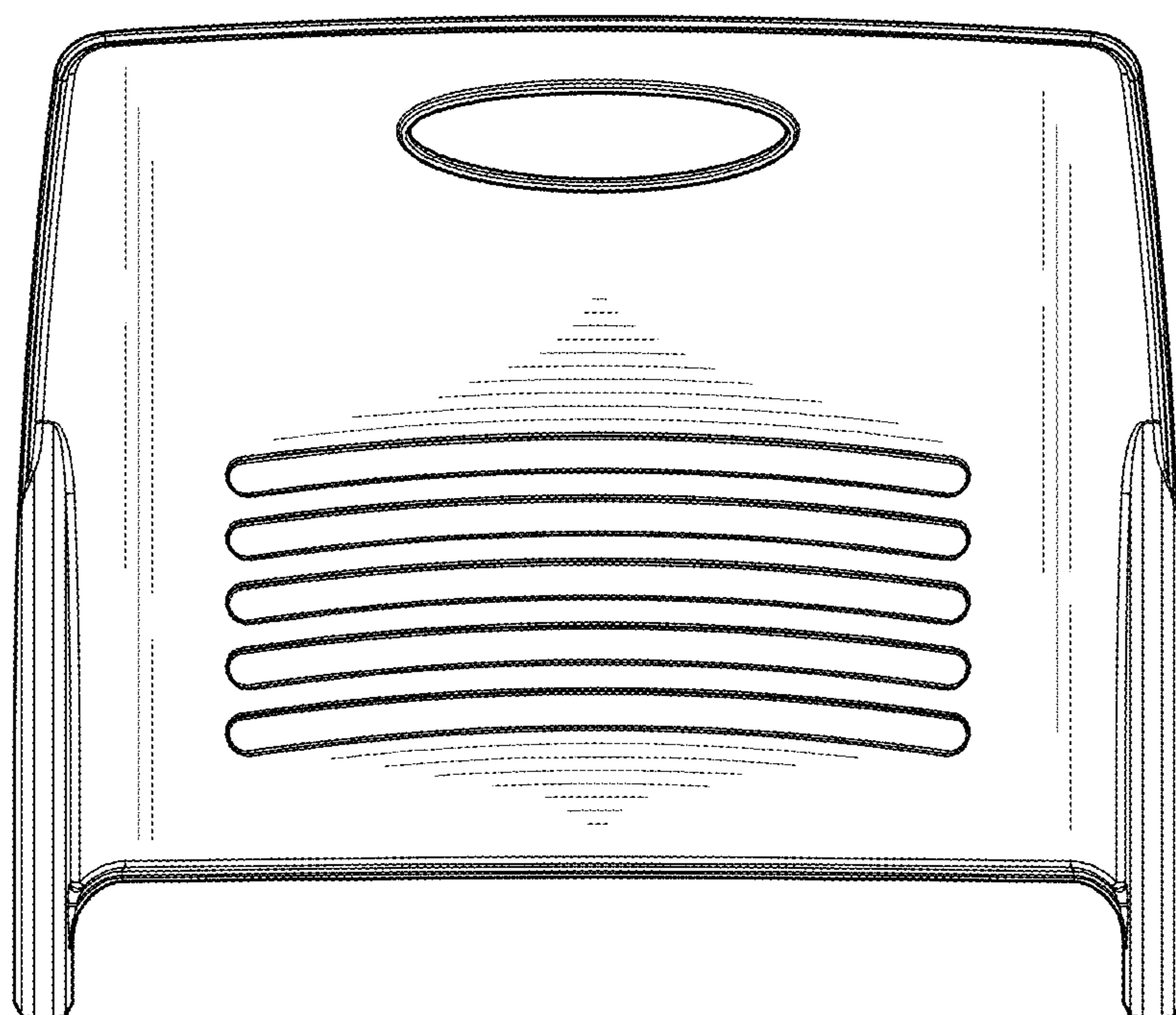

FIG. 3

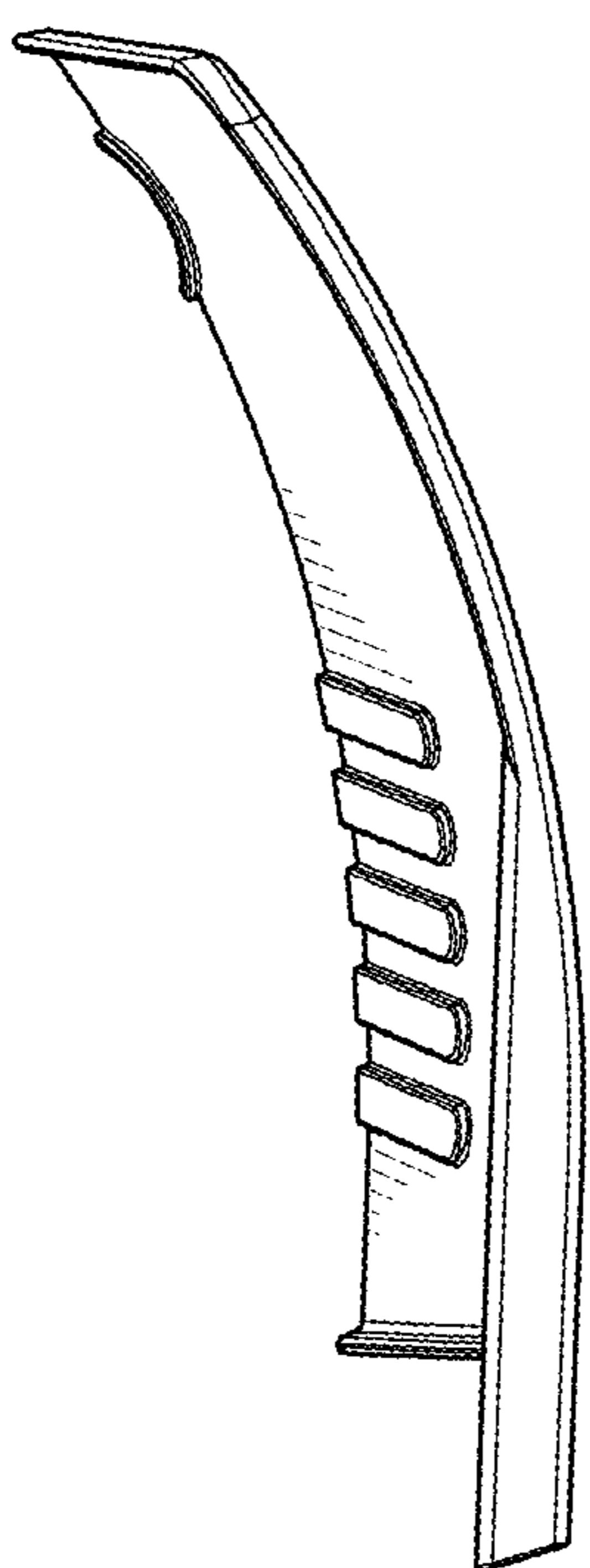

FIG. 4

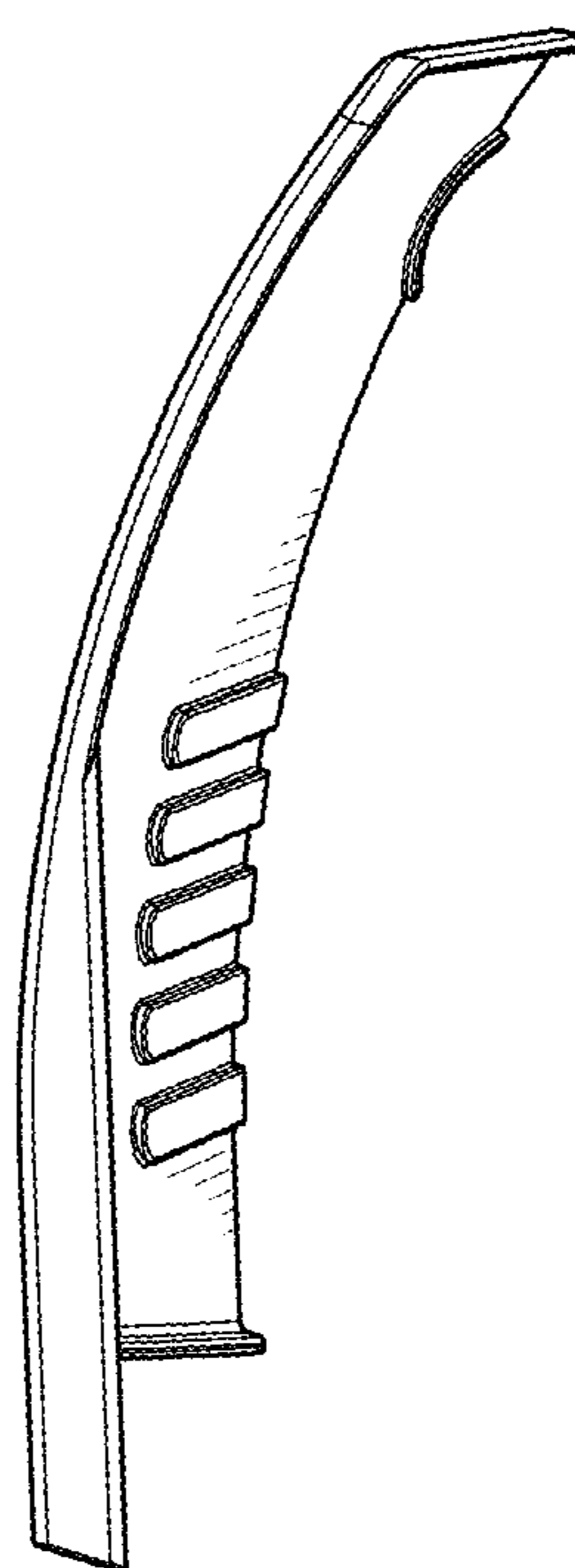

FIG. 5

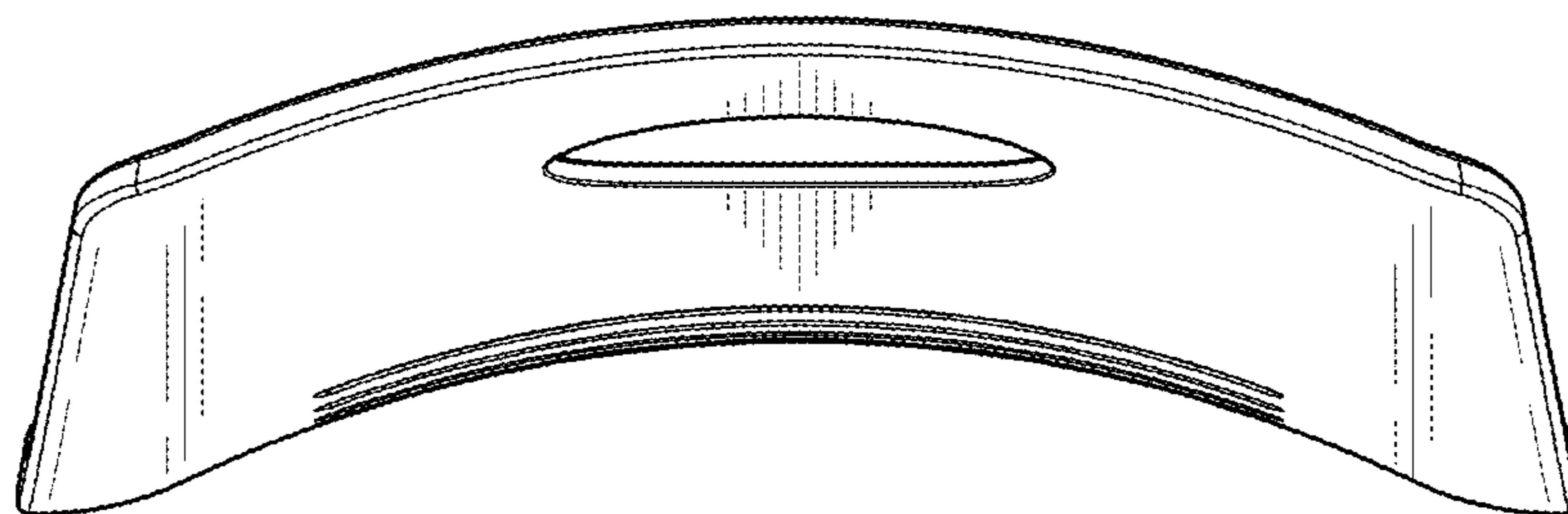

FIG. 6

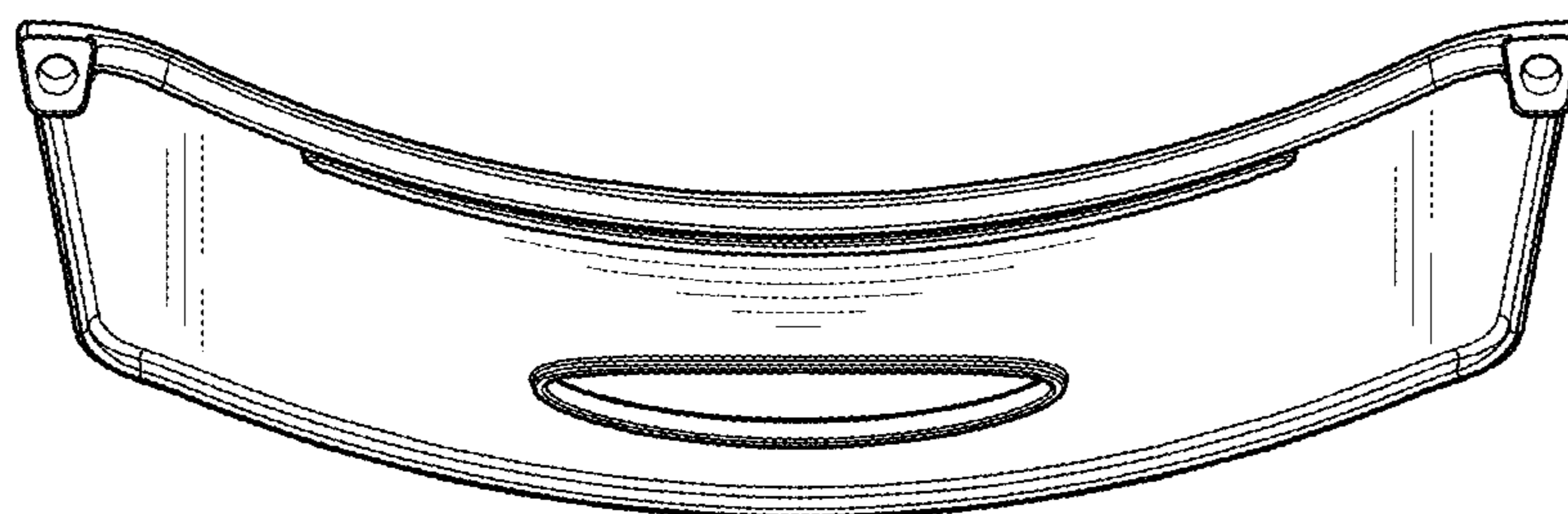

FIG. 7

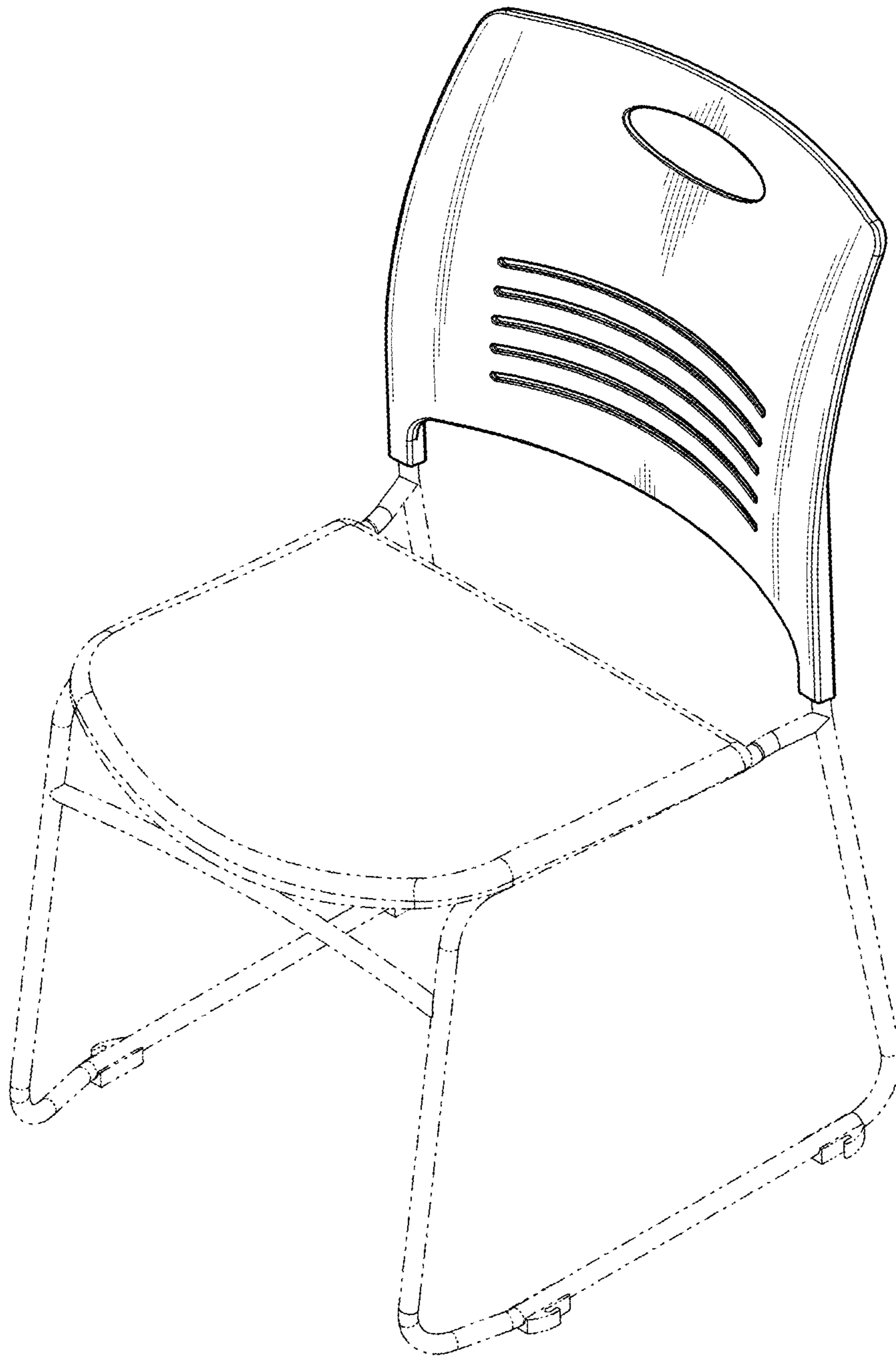

FIG. 8

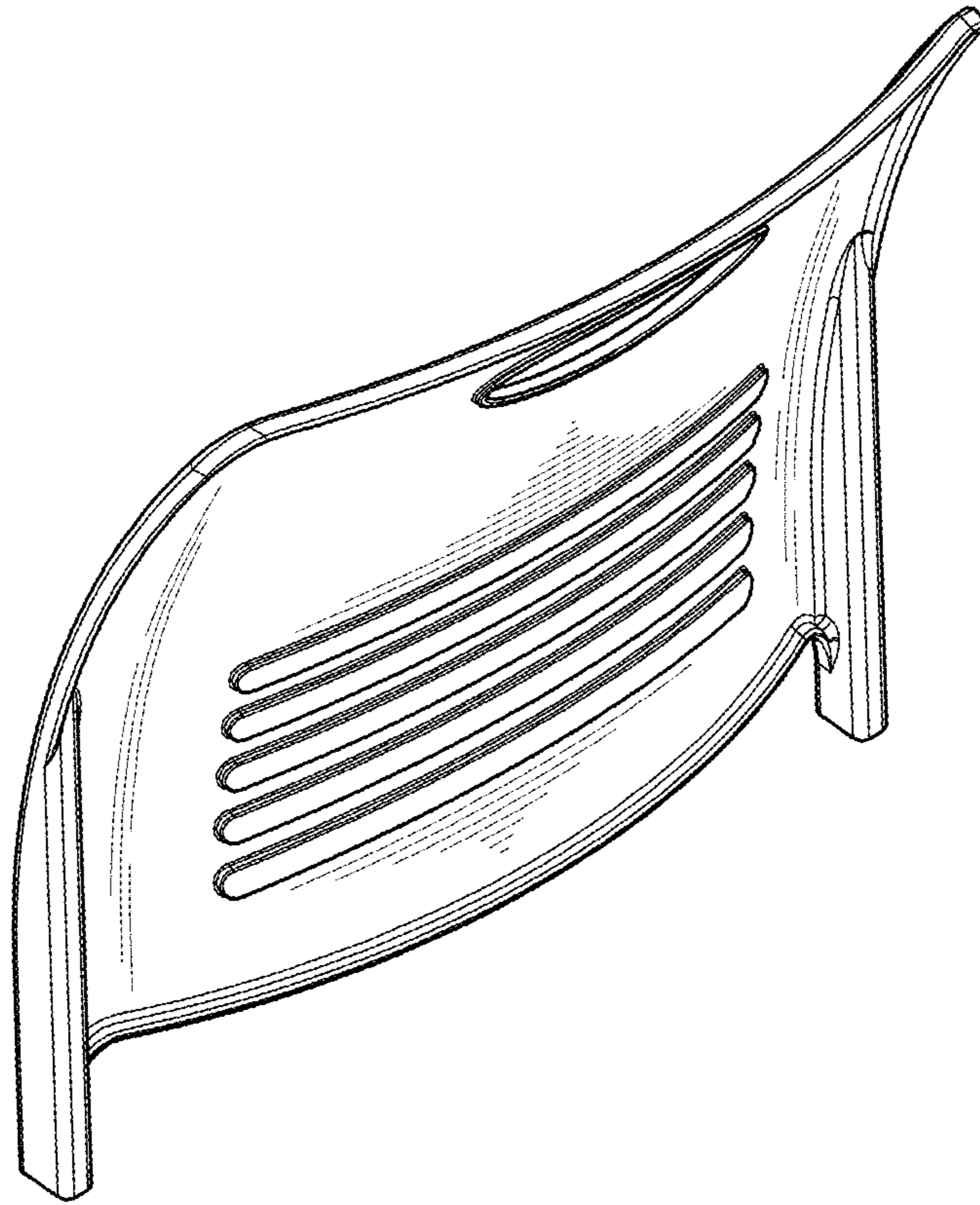

FIG. 9