



US00D769624S

(12) **United States Design Patent**
Collins-Sarner

(10) **Patent No.:** **US D769,624 S**
(45) **Date of Patent:** **** Oct. 25, 2016**

(54) **HANDBAG RAINCOAT**

(71) Applicant: **DRAM DESIGNS LLC**, Norwood, NJ
(US)

(72) Inventor: **Rhonda Collins-Sarner**, Norwood, NJ
(US)

(73) Assignee: **Dram Designs LLC**, Norwood, NJ
(US)

(**) Term: **14 Years**

(21) Appl. No.: **29/526,349**

(22) Filed: **May 8, 2015**

(51) **LOC (10) Cl.** **03-01**

(52) **U.S. Cl.**
USPC **D3/318**

(58) **Field of Classification Search**
USPC D3/318
CPC A45C 3/08; A45C 13/06; A45C 13/08;
A45C 13/26

See application file for complete search history.

(56) **References Cited**

U.S. PATENT DOCUMENTS

- 2,107,347 A * 2/1938 Sloane A45C 13/08
150/105
- 2,118,400 A * 5/1938 Goldberg A45C 3/08
150/105
- D719,354 S * 12/2014 Yu D3/318

* cited by examiner

Primary Examiner — Holly Baynham

(74) *Attorney, Agent, or Firm* — Millen White Zelano & Branigan, P.C.

(57) **CLAIM**

The ornamental design for a handbag raincoat, as shown and described.

DESCRIPTION

FIG. 1 is a front view of handbag raincoat.
 FIG. 2 is a back view thereof.
 FIG. 3 is a top view thereof.
 FIG. 4 is a bottom view thereof.
 FIG. 5 is a side view thereof.
 FIG. 6 is another side view thereof.
 FIG. 7 is a perspective view thereof; and,
 FIG. 8 is another perspective view thereof in an environment use.

The smooth zigzag line along the top portion of the handbag raincoat is indicative of the joining of two sides, for example, by a hook and loop fastener.

The broken lines in the drawings form no part of the claimed design.

1 Claim, 7 Drawing Sheets

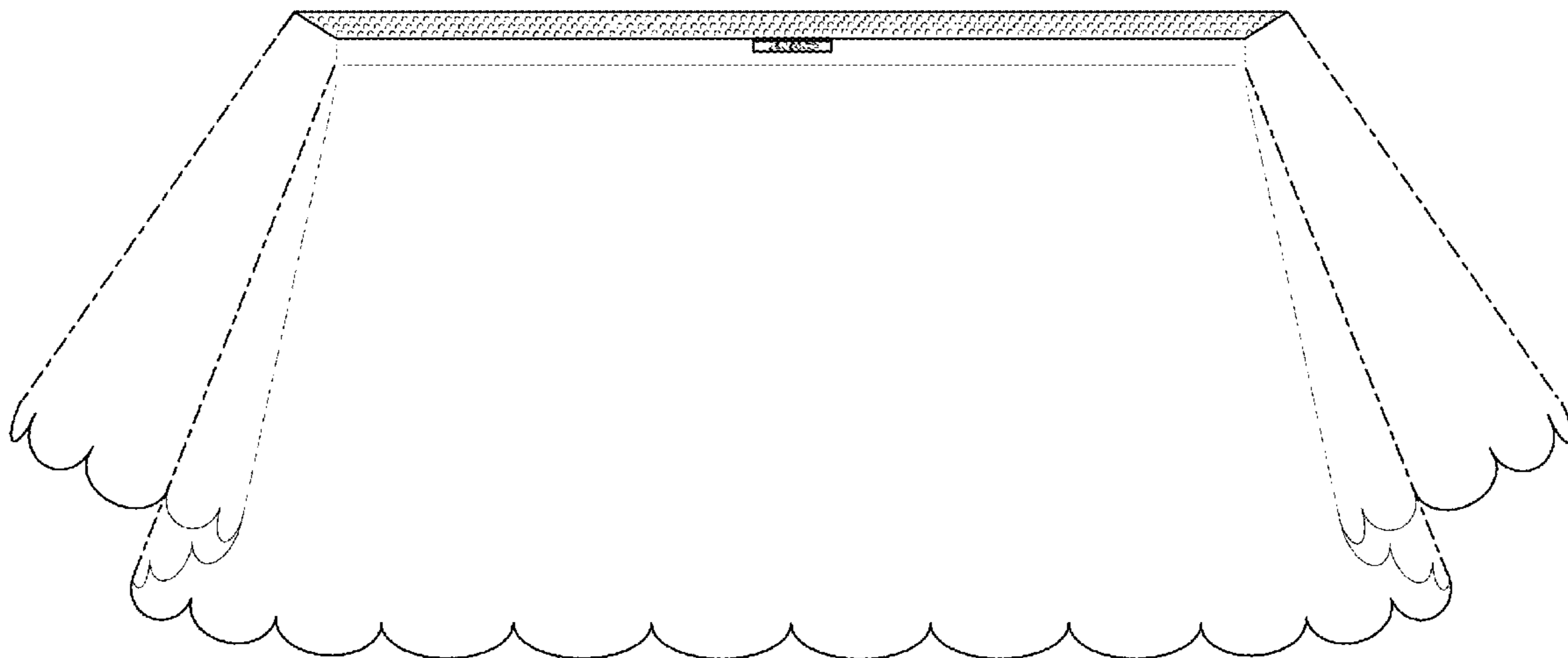

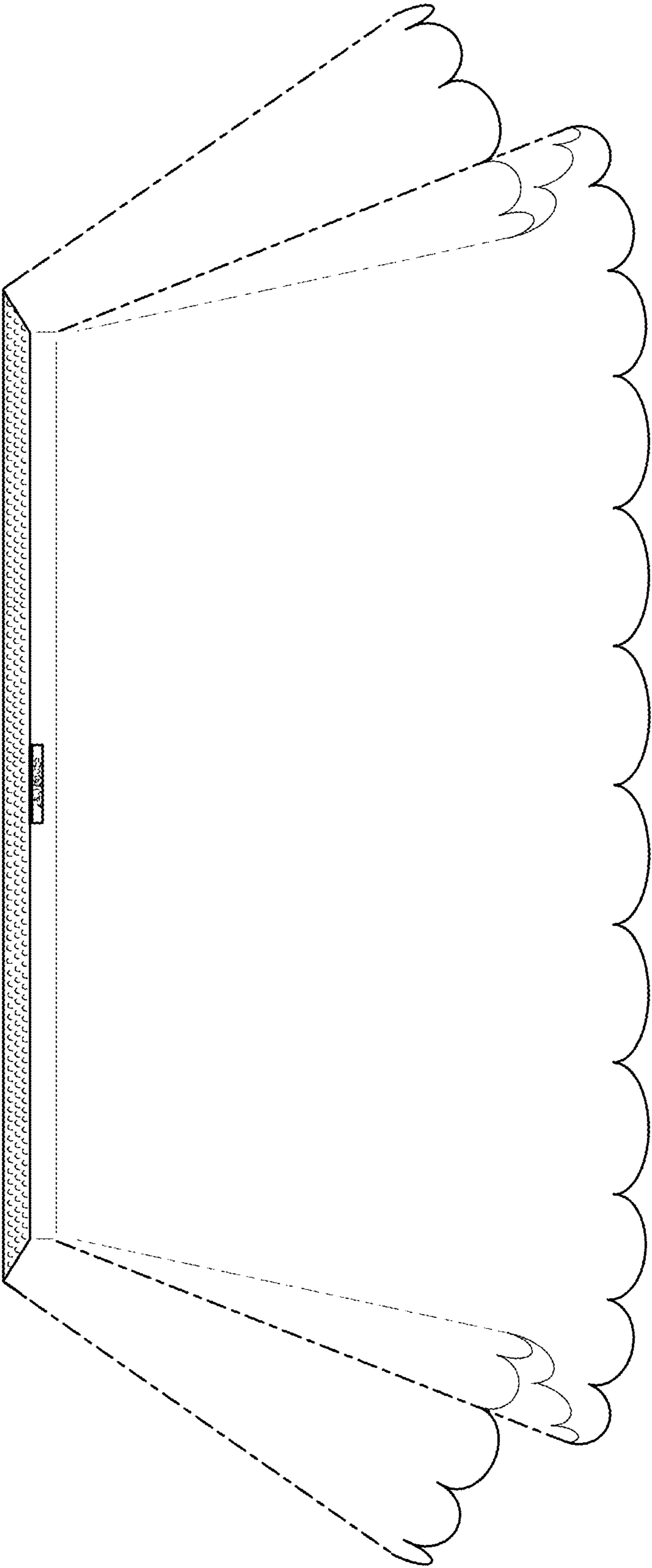

FIG.1

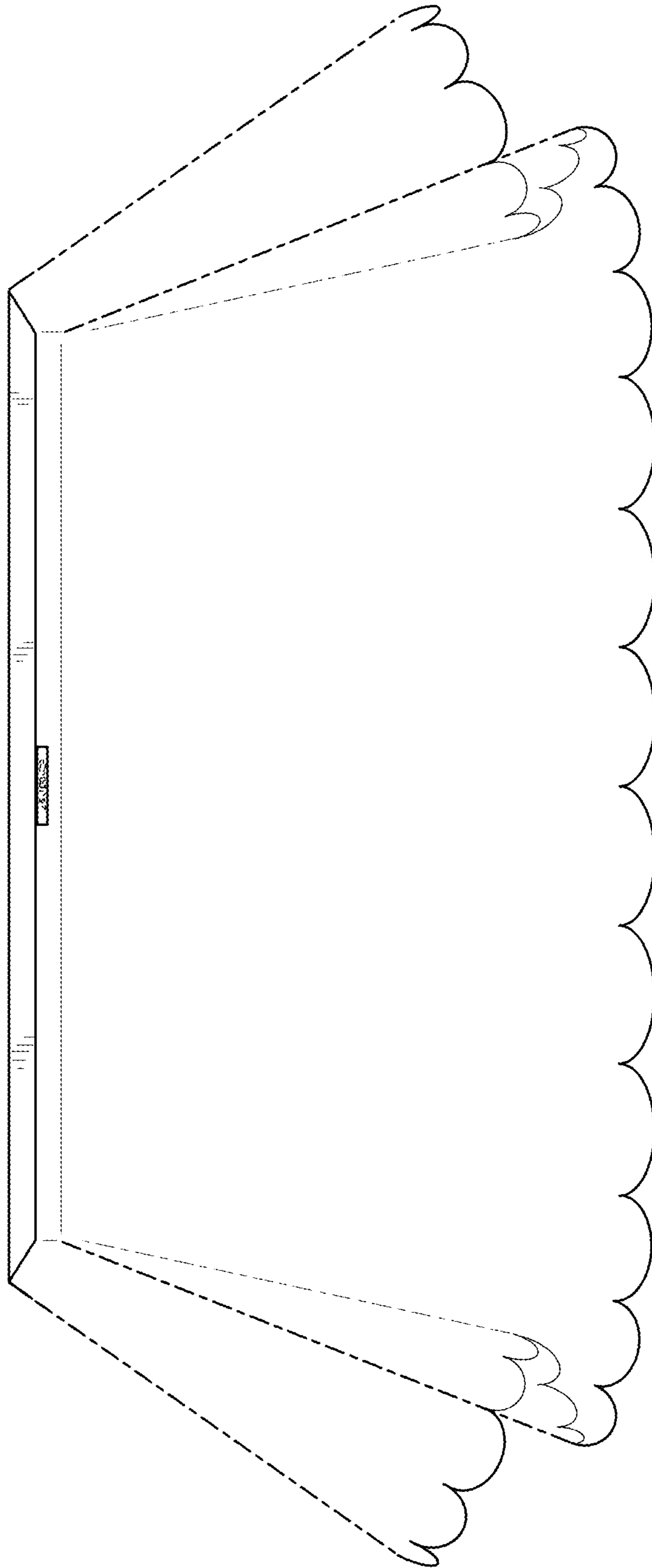

FIG.2

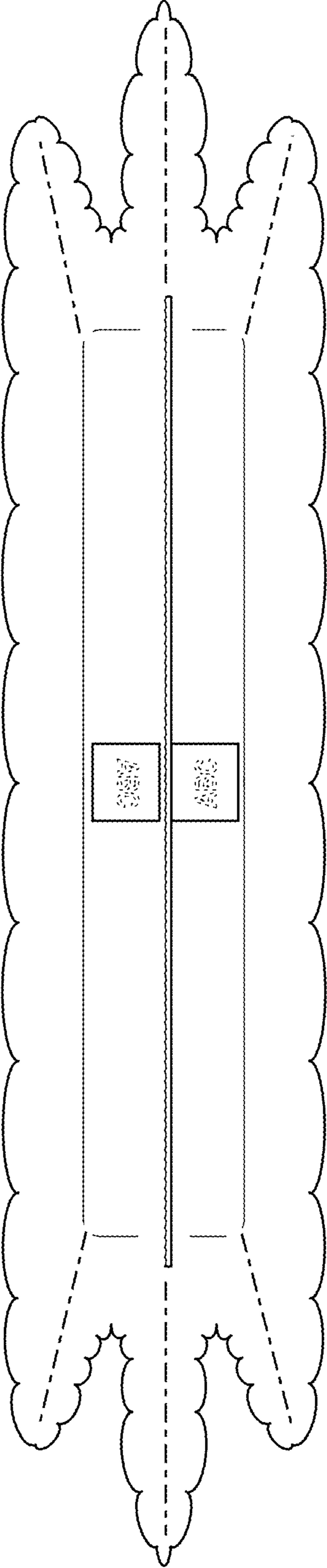

FIG.3

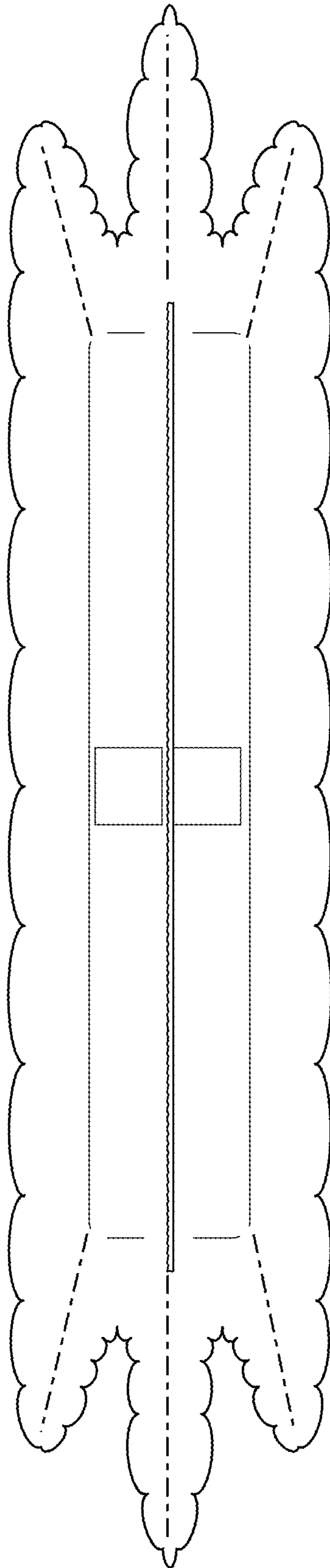

FIG.4

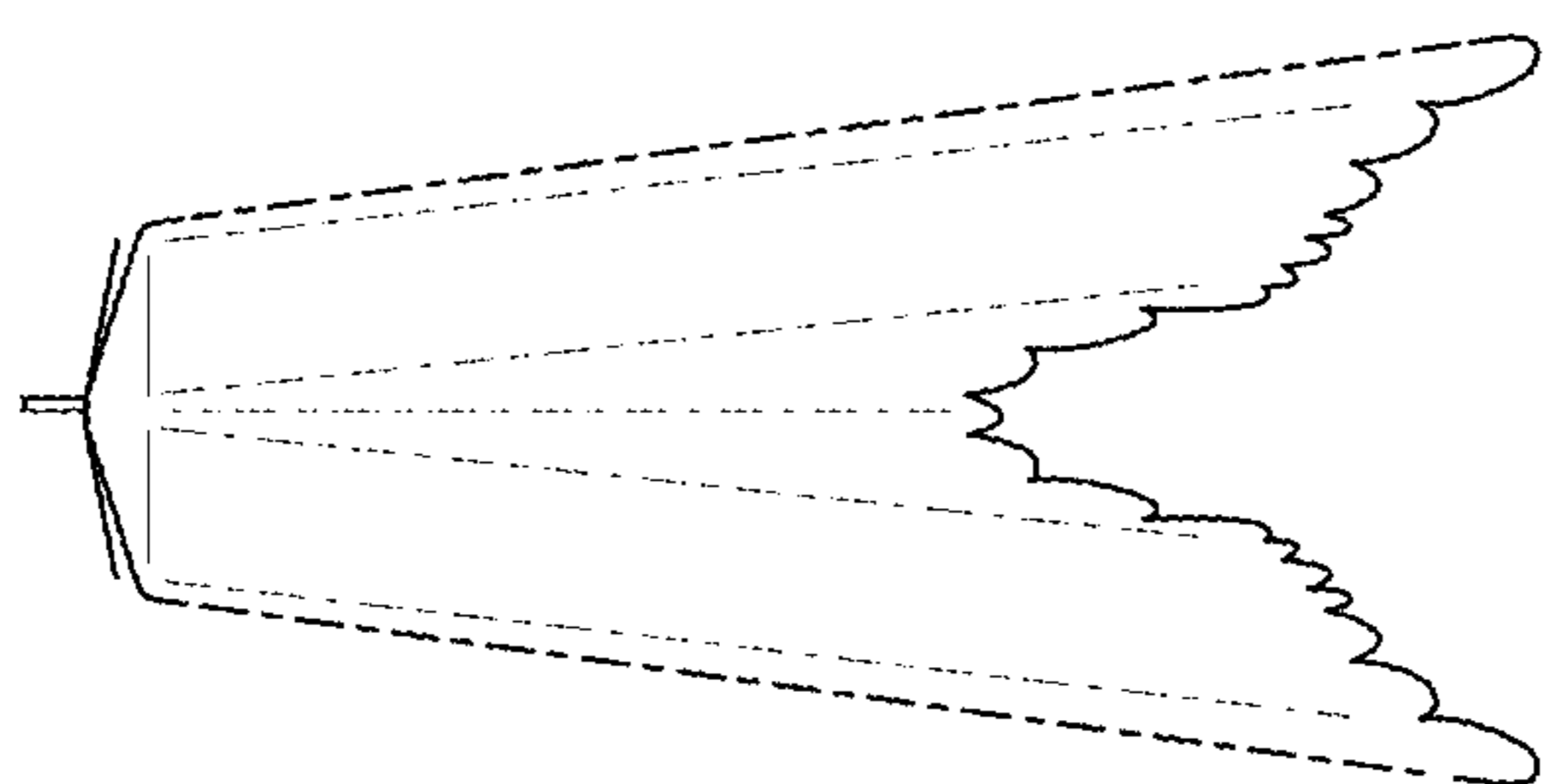

FIG.6

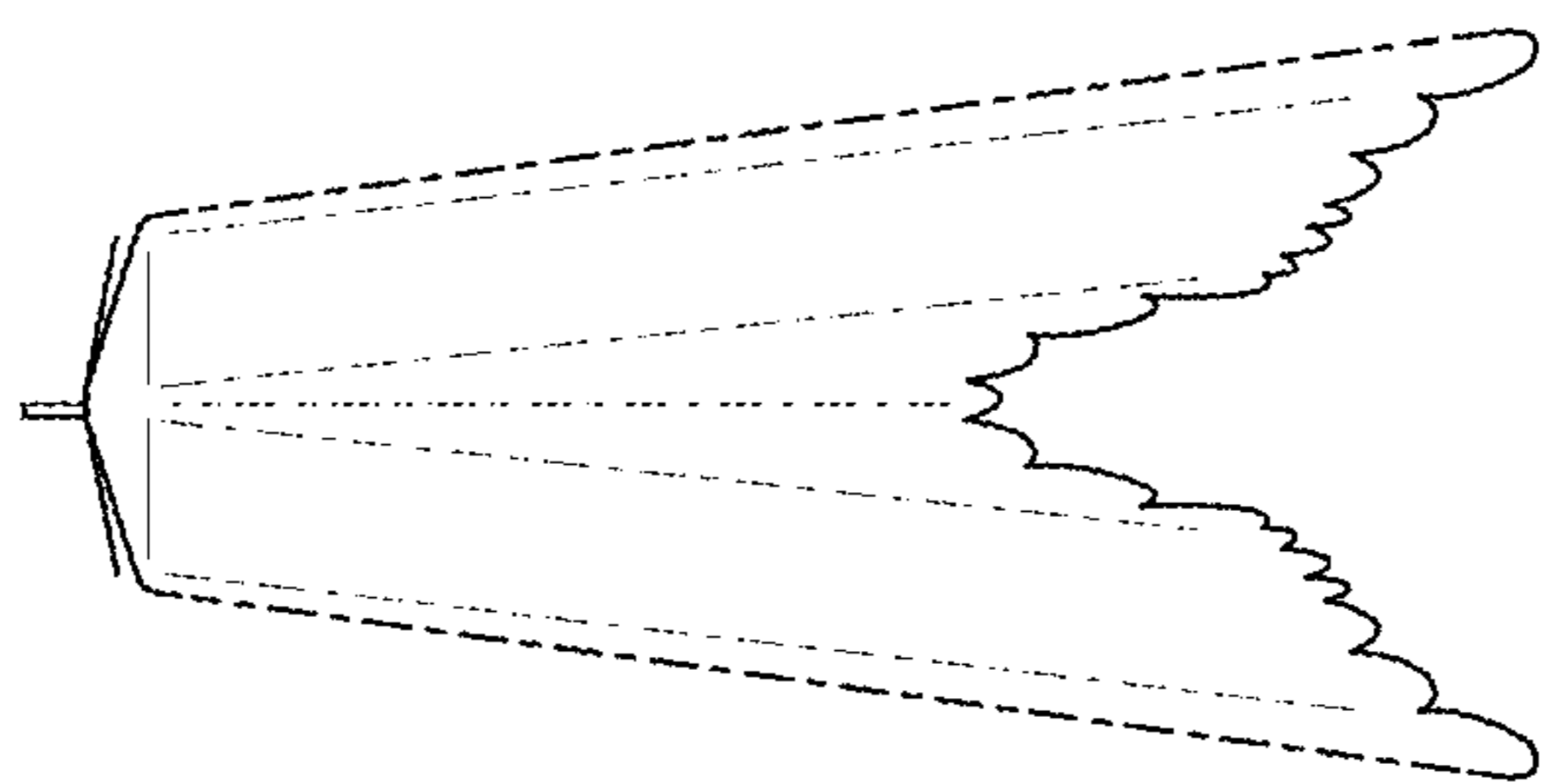

FIG.5

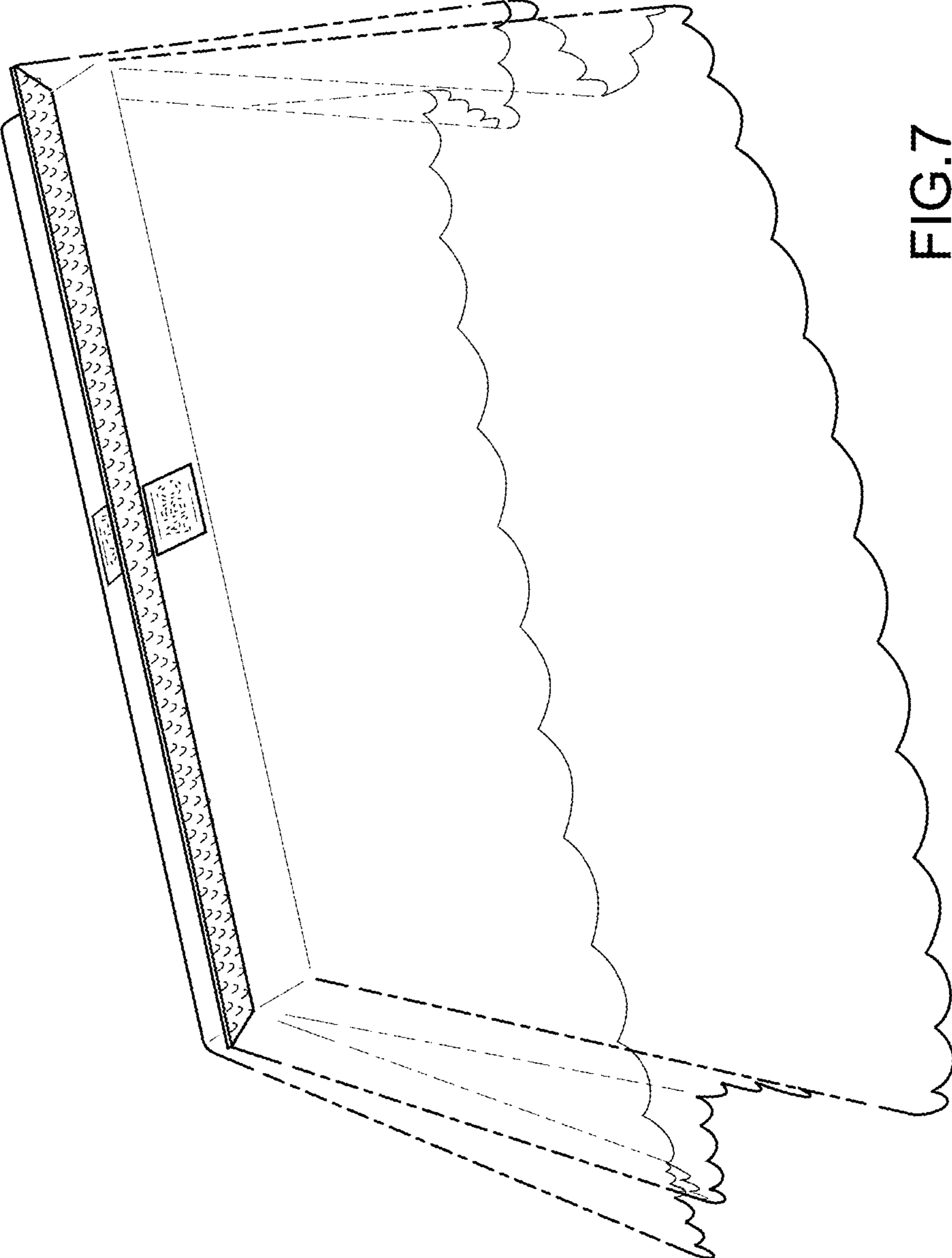

FIG.7

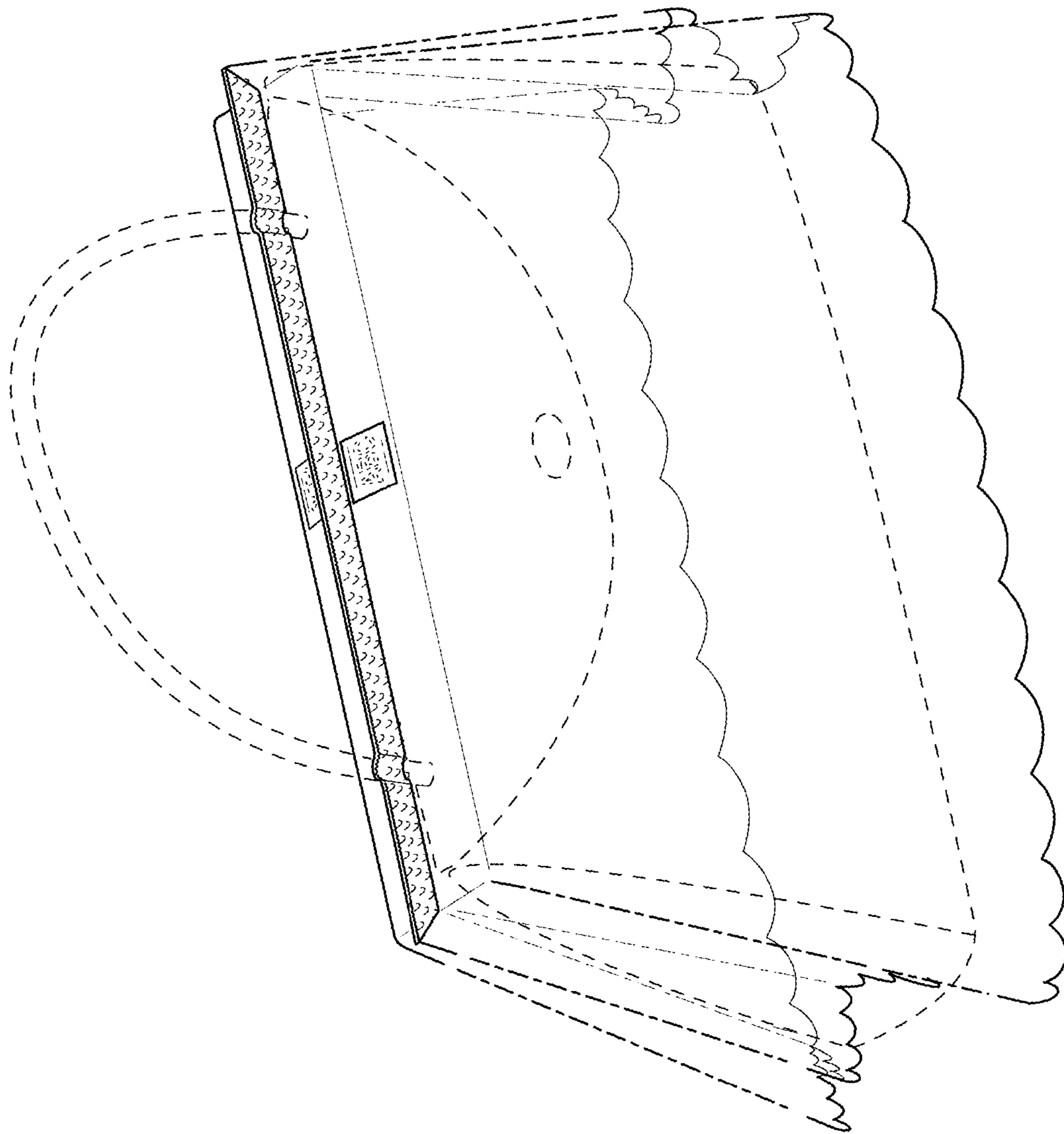

FIG.8