



US00D769544S

(12) **United States Design Patent**  
**Niedwick et al.**

(10) **Patent No.:** **US D769,544 S**

(45) **Date of Patent:** **\*\* Oct. 18, 2016**

(54) **ANIMAL HABITAT**

(71) Applicant: **Arni Says Saves LLC**, Daytona Beach, FL (US)

(72) Inventors: **Russell Richard Niedwick**, Tustin, CA (US); **Nicole Marisa Linn**, Ormond Beach, FL (US); **Paul Hendrikx**, Breda (NL); **Melchior van Voorden**, Breda (NL); **Hendrik Richard Ulderink**, Utrecht (NL)

(73) Assignee: **Arni Says Saves, LLC**, Daytona Beach, FL (US)

(\*\*) Term: **15 Years**

(21) Appl. No.: **29/527,317**

(22) Filed: **May 18, 2015**

(51) **LOC (10) Cl.** ..... **30-02**

(52) **U.S. Cl.**  
USPC ..... **D30/112; D30/118; D30/161**

(58) **Field of Classification Search**  
USPC ..... **D30/108-112, 117-118, 161; D6/691.8, 691.9, 663-664, 304; D25/4, 22**

CPC ..... **A01K 1/0245; A01K 1/03; A01K 1/033; A01K 31/002; A01K 31/18; A47D 13/02; A47D 13/025**

See application file for complete search history.

(56) **References Cited**

**U.S. PATENT DOCUMENTS**

4,301,766 A	11/1981	Piccone	
D264,887 S *	6/1982	Tweed	D30/112
D290,767 S *	7/1987	Duffek	D30/108
5,080,042 A	1/1992	Rubin	
5,134,970 A *	8/1992	Oh	A01K 31/14 119/428
D360,304 S *	7/1995	Fachinger	D6/304
D360,489 S *	7/1995	Sylor	D30/108
5,465,682 A	11/1995	Chavallo, Jr.	

5,711,253 A	1/1998	Phillips et al.	
5,722,446 A	3/1998	Zheng	
6,210,247 B1 *	4/2001	Rodriguez Ferre	A63B 9/00 446/476
6,298,808 B1	10/2001	Crafton et al.	
6,857,393 B2	2/2005	Cheshire	
D502,576 S *	3/2005	Miller	D30/161
6,886,495 B1	5/2005	Madden et al.	
7,021,243 B2	4/2006	Harper et al.	
D522,183 S *	5/2006	Wylie	D30/118
7,191,734 B2	3/2007	Strzempko et al.	
7,578,264 B2	8/2009	Guard	
D617,505 S *	6/2010	Platt	D30/108
D618,859 S *	6/2010	Hudson	D30/108
D625,057 S *	10/2010	Teper	D30/161
D629,973 S *	12/2010	Morton	D30/108
8,113,149 B2	2/2012	Quinn	
D676,613 S	2/2013	Chiu	
D685,139 S *	6/2013	Park	D30/108
D697,692 S *	1/2014	Kerr	D1/199
8,640,652 B2	2/2014	Callari	
D726,971 S *	4/2015	Itzhak-Sigron	D30/118

\* cited by examiner

*Primary Examiner* — Cathy Anne MacCormac

(74) *Attorney, Agent, or Firm* — Myers Bigel & Sibley, PA

(57) **CLAIM**

The ornamental design for an animal habitat, as shown and described.

**DESCRIPTION**

FIG. 1 is a front, top and right side perspective view of an animal habitat showing our design; FIG. 2 is a rear, top and left side perspective view thereof; FIG. 3 is a front view thereof; FIG. 4 is a rear view thereof; FIG. 5 is a left side view thereof, the right side view being identical to the left side view; FIG. 6 is a top view thereof; and, FIG. 7 is a bottom view thereof.

The broken lines in the drawings depict environmental subject matter and form no part of the claimed design.

**1 Claim, 7 Drawing Sheets**

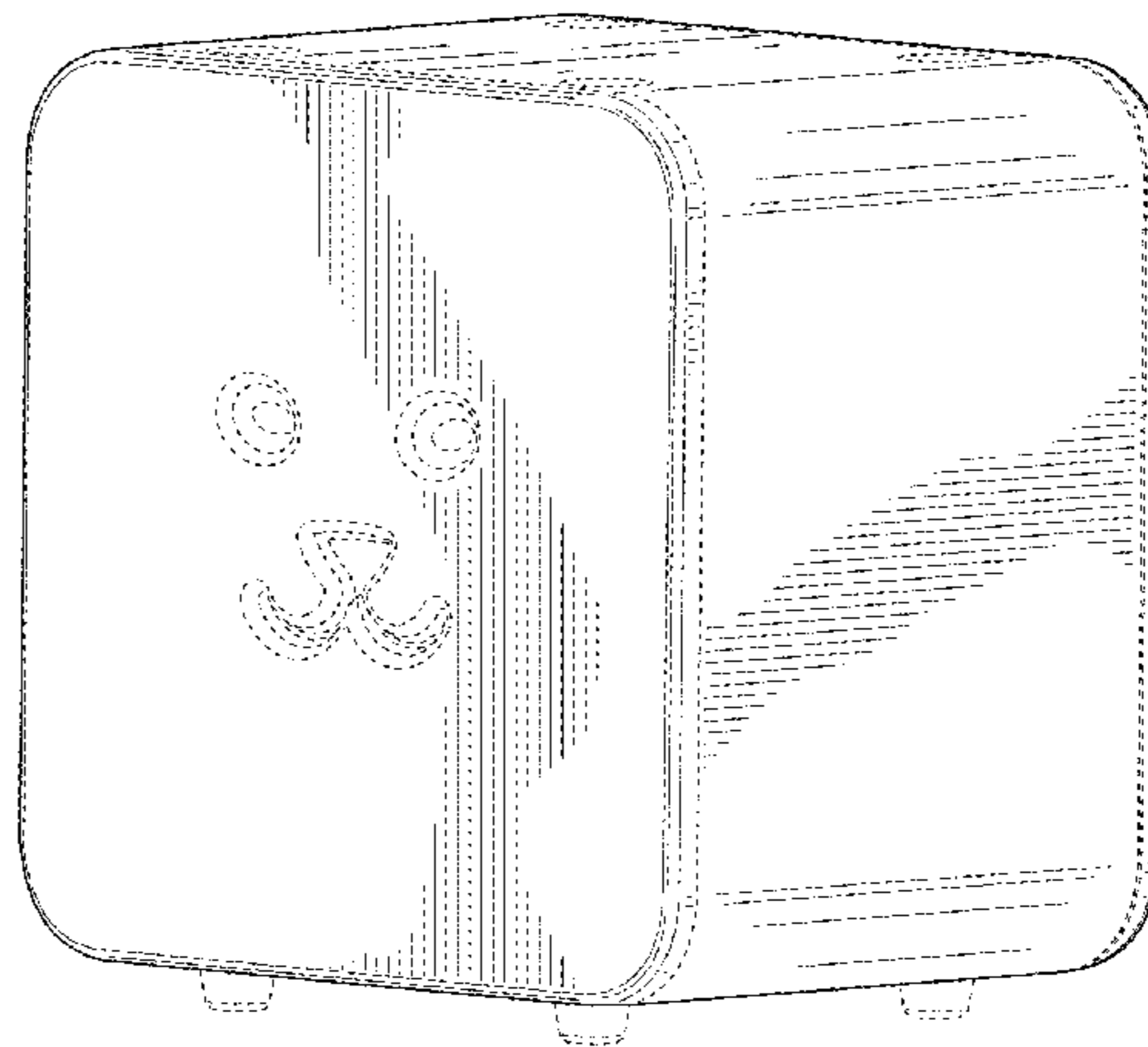
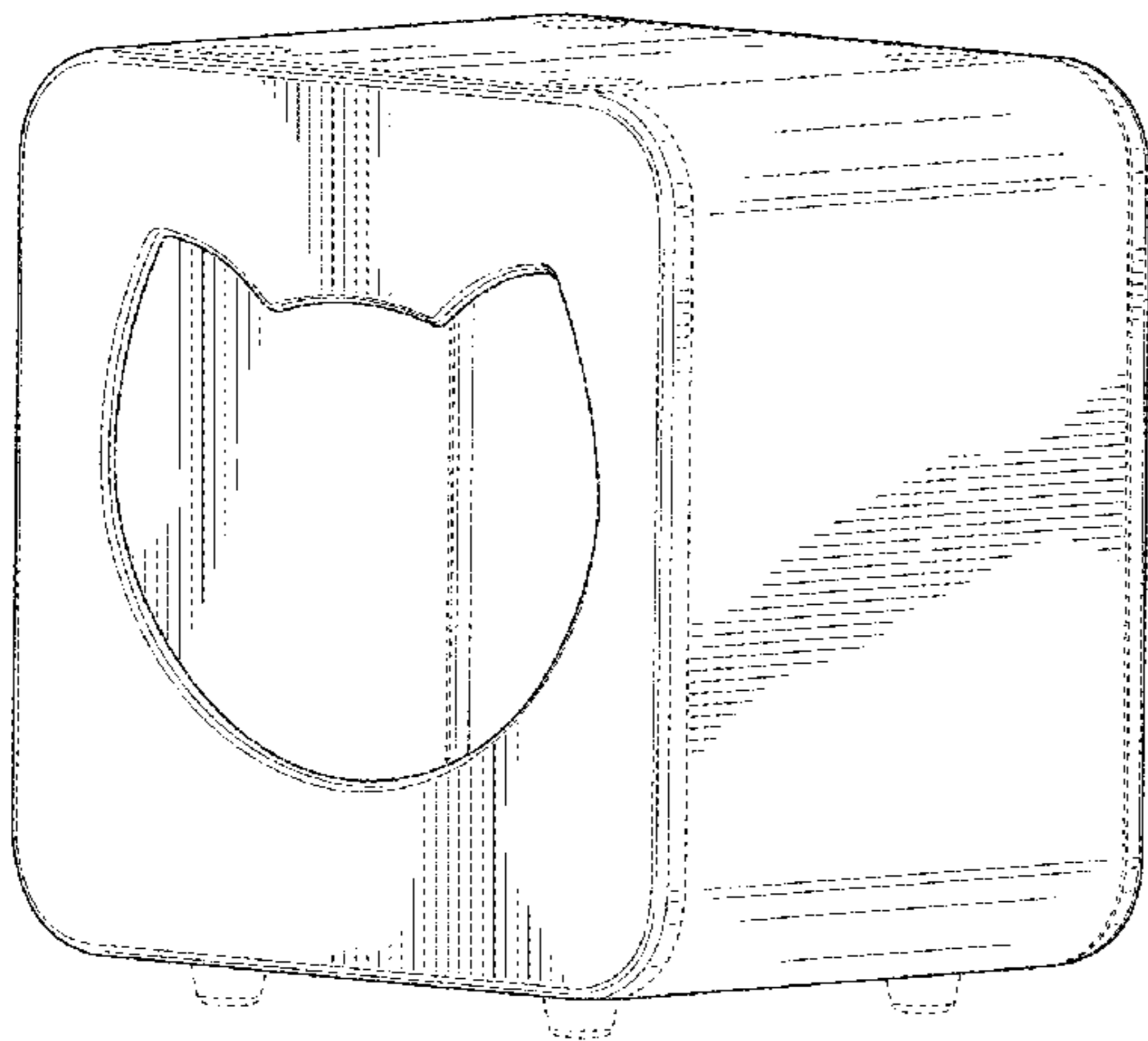

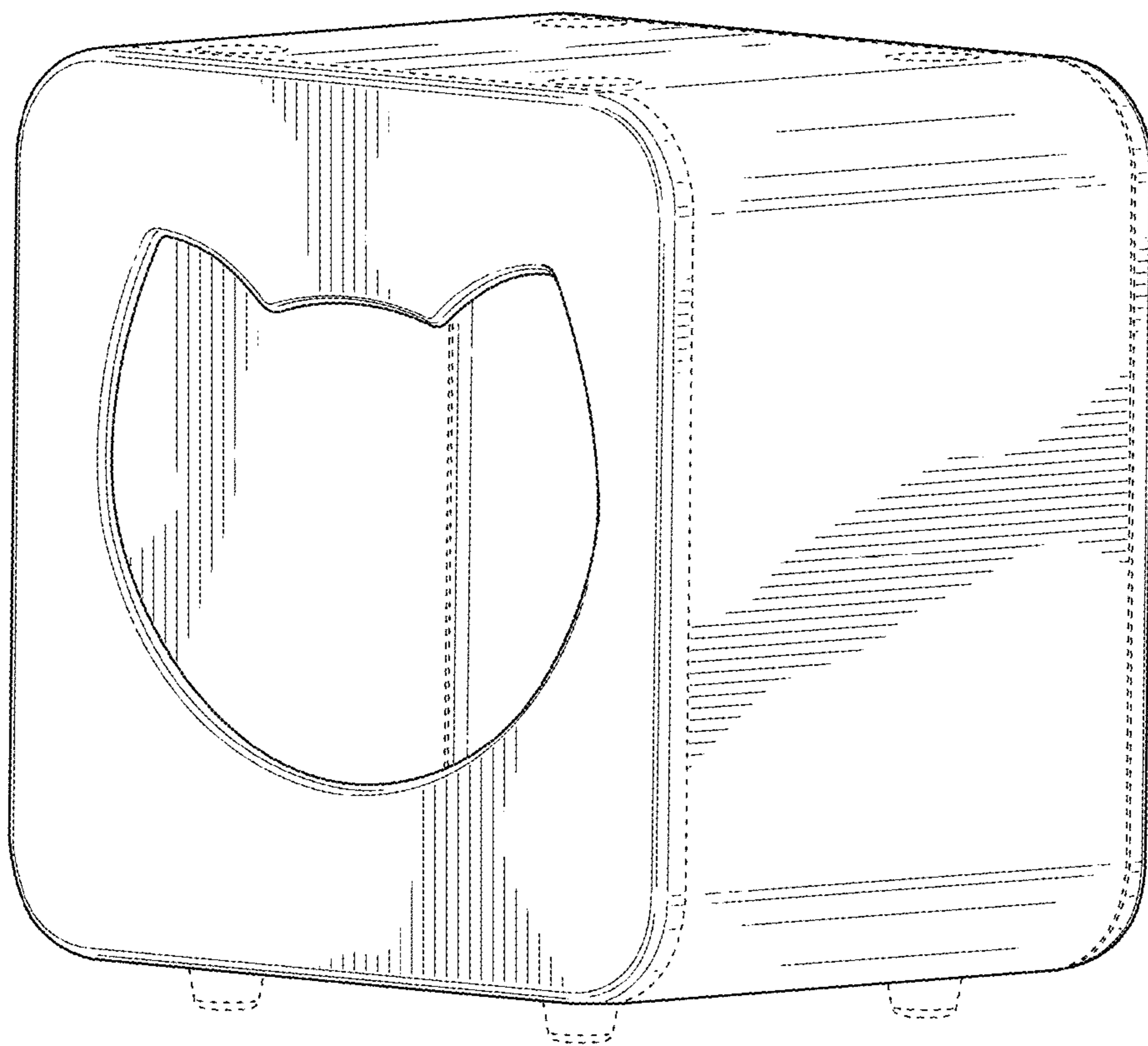

**FIG. 1**

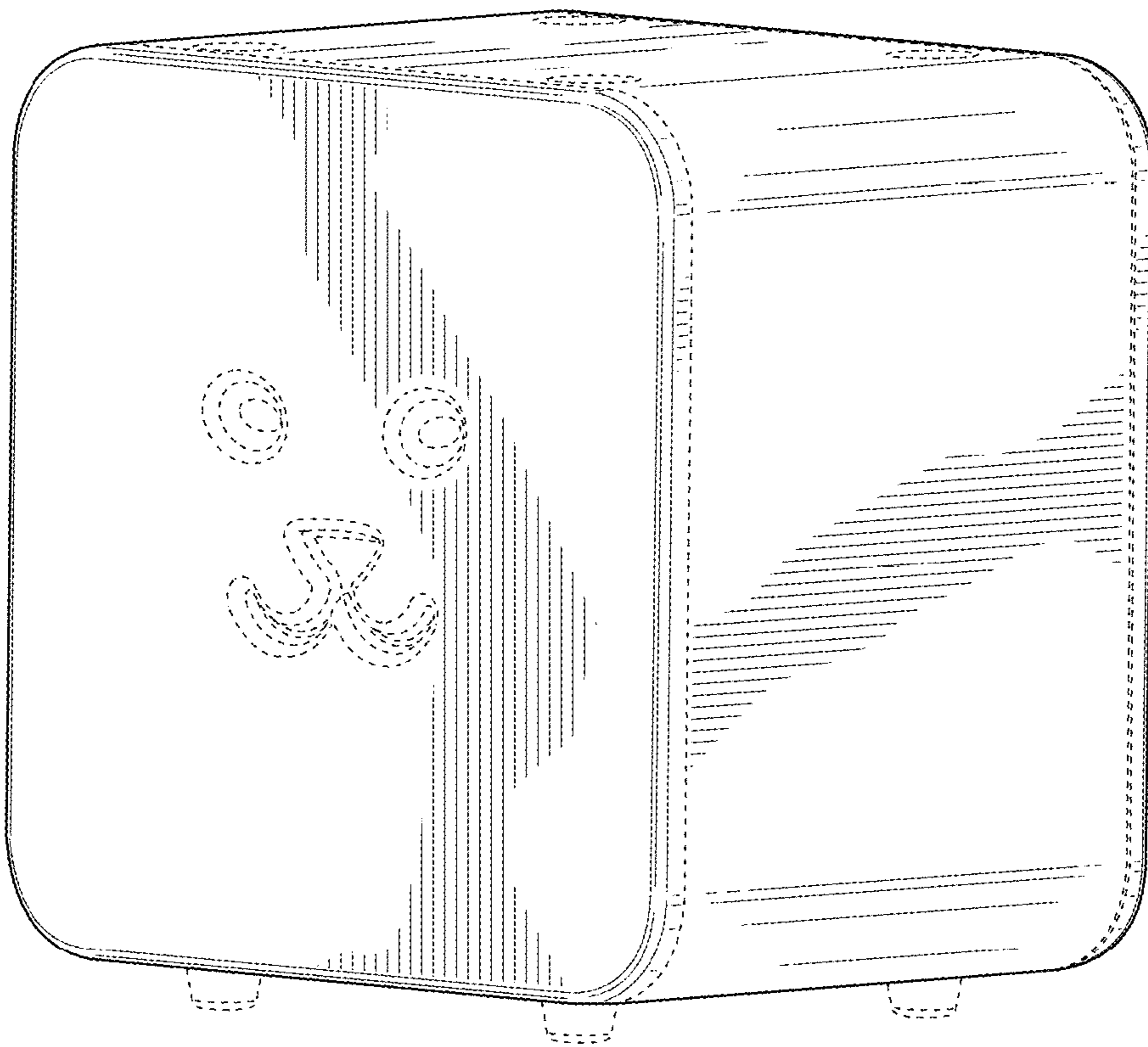
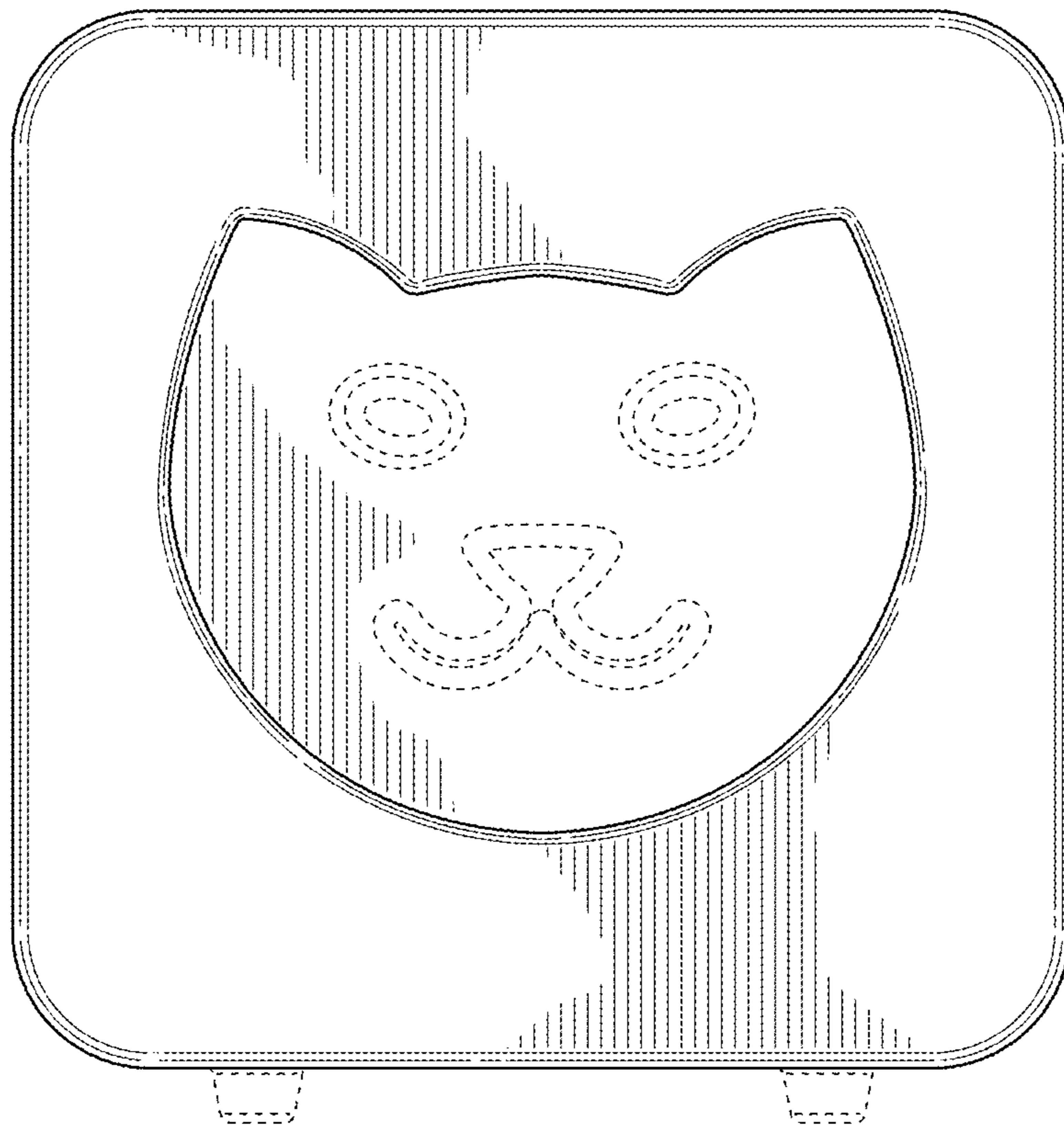
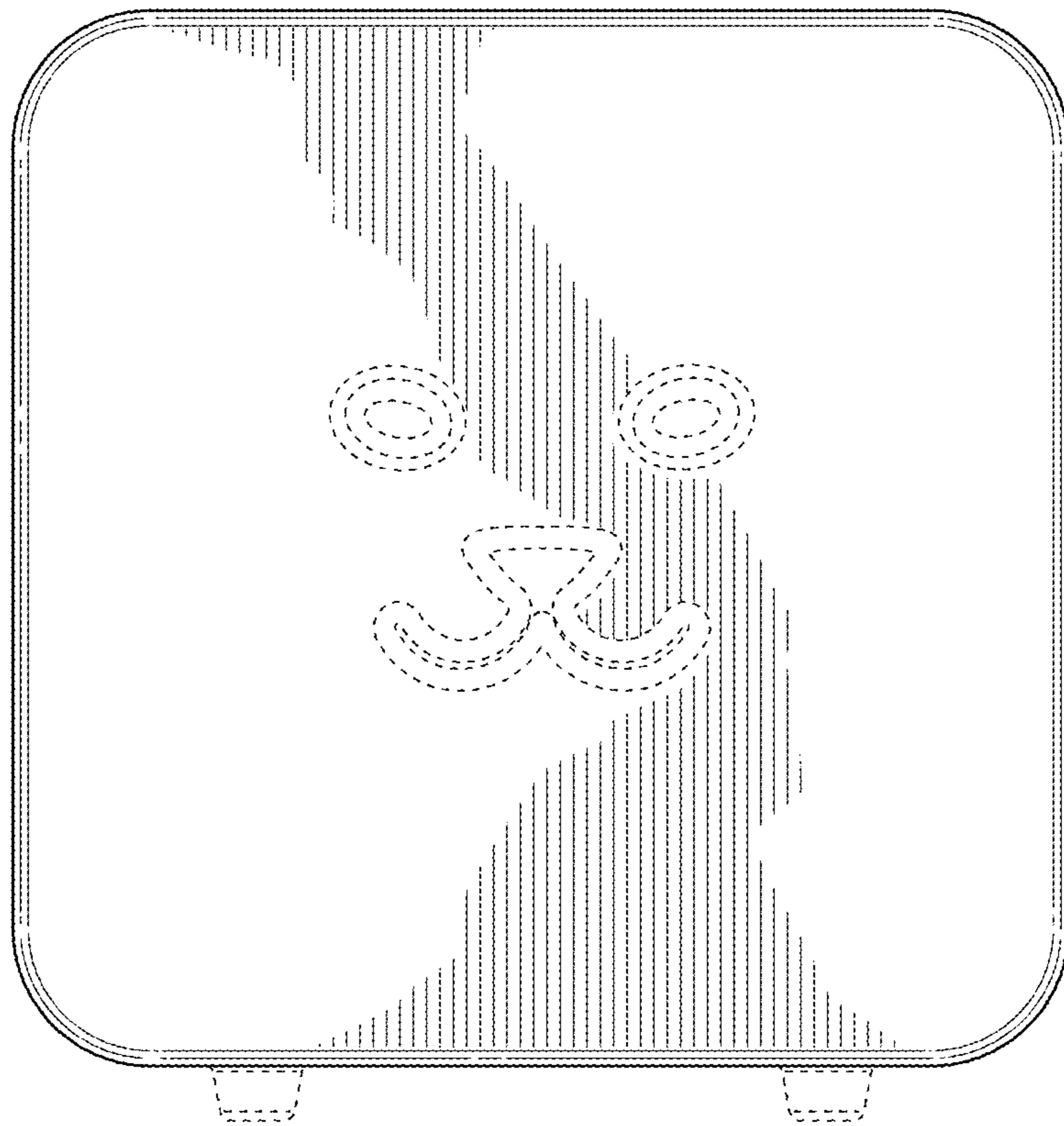

FIG. 2



**FIG. 3**



**FIG. 4**

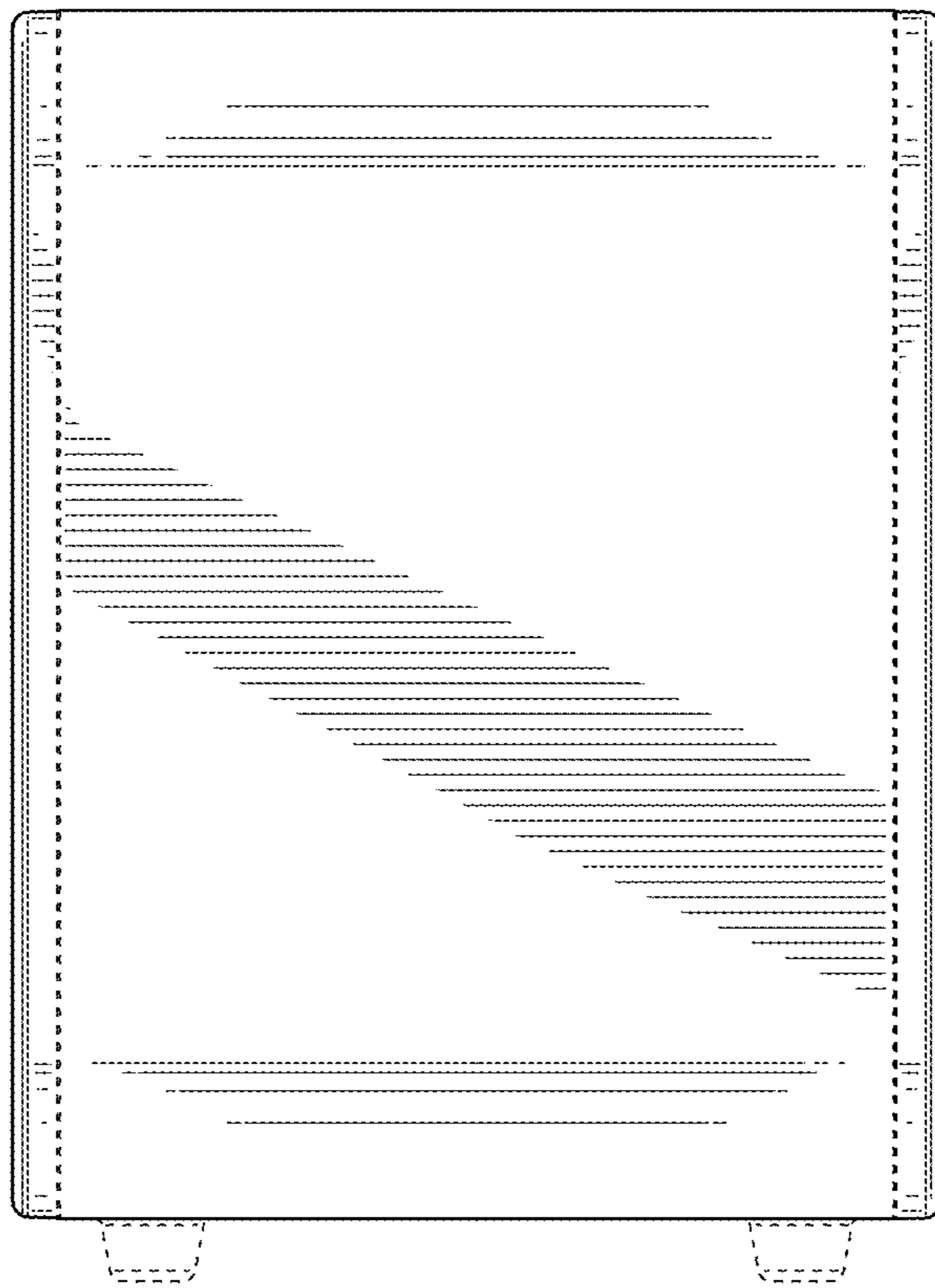

**FIG. 5**

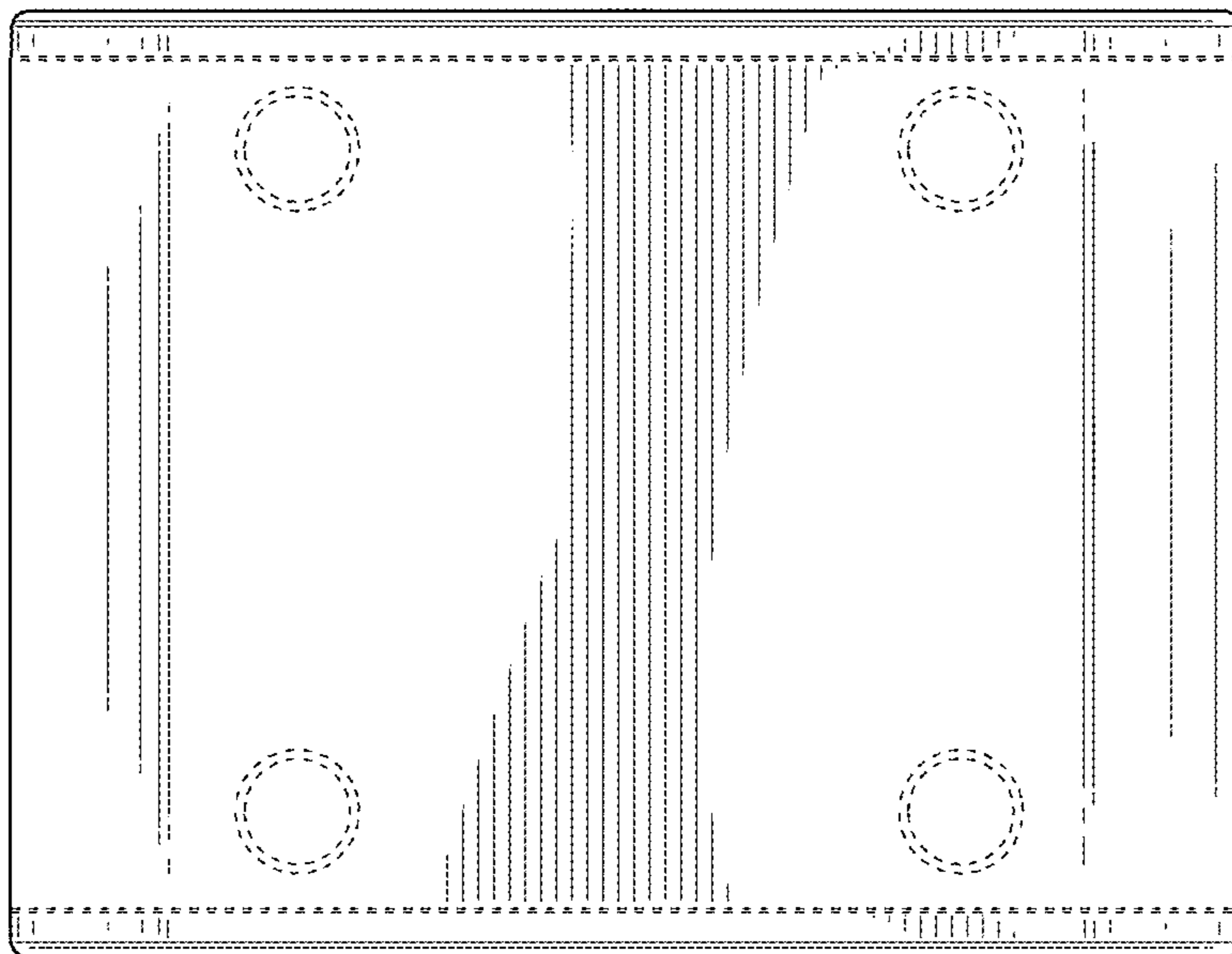

**FIG. 6**

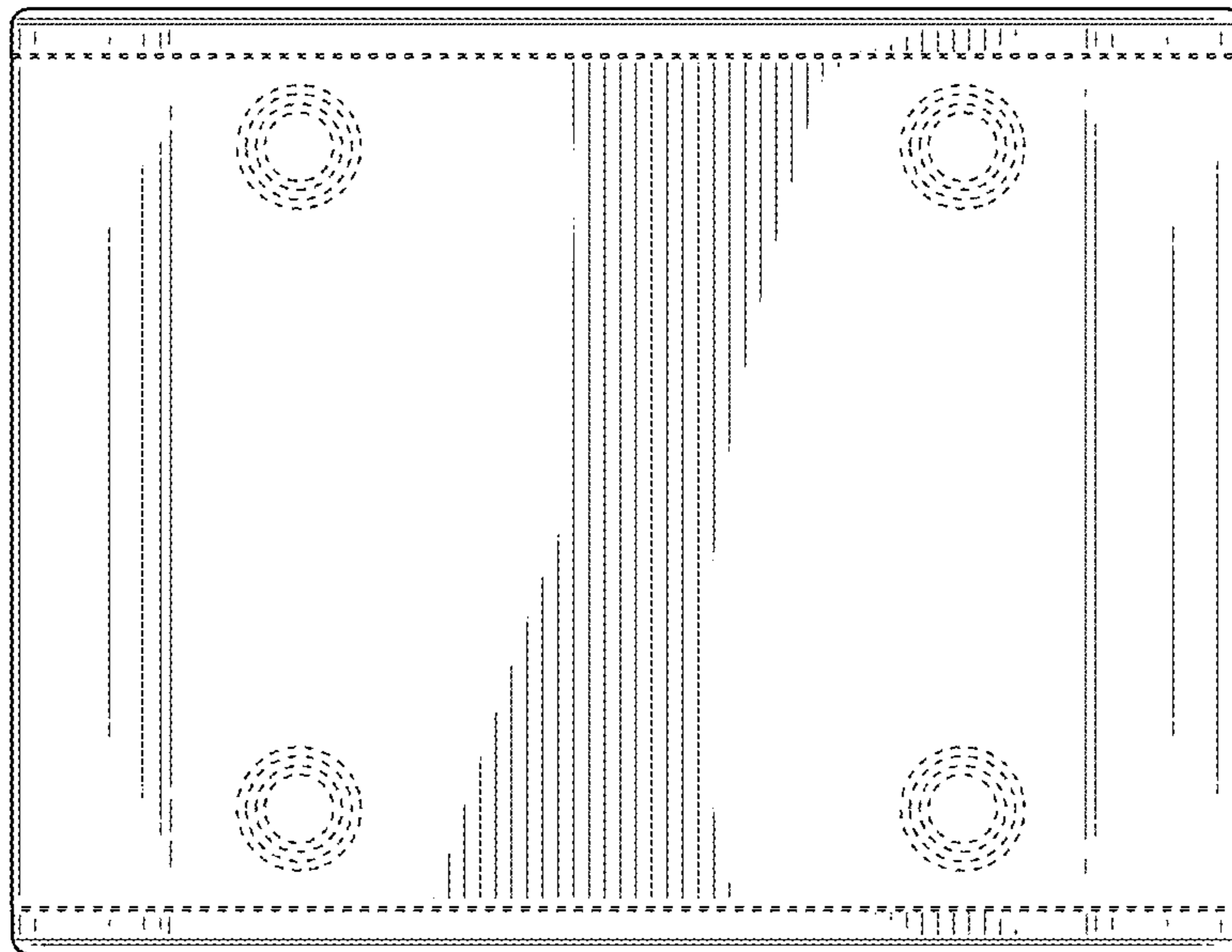

**FIG. 7**