



US00D769538S

(12) **United States Design Patent**  
**Gutman**

(10) **Patent No.:** **US D769,538 S**

(45) **Date of Patent:** **\*\* \*Oct. 18, 2016**

(54) **WEIGHT LIFTING GRIP WITH WRIST SUPPORT**

D320,872 S \* 10/1991 McCrane ..... D29/113

5,079,776 A \* 1/1992 Crawford ..... A63B 71/141  
2/162

5,353,440 A \* 10/1994 Meldeau ..... A41D 19/01547  
2/161.1

(71) Applicant: **NAYOYA WELLNESS CORP.**, Glen Cove, NY (US)

(Continued)

(72) Inventor: **Yan Gutman**, Brooklyn, NY (US)

**OTHER PUBLICATIONS**

(73) Assignee: **Nayoya Wellness Corp.**, Glen Cove, NY (US)

Weight Lifting Straps (Nayoya Workout Grips), available Mar. 16, 2014, [online], [site visited Sep. 15, 2015]. Available from internet, <URL: <http://www.amazon.com/Weight-Lifting-Straps-Adjustable-Protecting/dp/B00HUFXXZG4>>.\*

(\*) Notice: This patent is subject to a terminal disclaimer.

(Continued)

(\*\*) Term: **14 Years**

*Primary Examiner* — Cathron Brooks  
*Assistant Examiner* — Teddy Falloway

(21) Appl. No.: **29/493,322**

(74) *Attorney, Agent, or Firm* — Anna Vishev

(22) Filed: **Jun. 9, 2014**

(51) **LOC (10) Cl.** ..... **29-02**

(52) **U.S. Cl.**  
USPC ..... **D29/113; D29/120.1**

(58) **Field of Classification Search**

USPC ..... D29/113, 114, 116.1, 116.2, 117.1, D29/117.2, 118, 119, 120.1, 122, 123; D3/215, 269, 270, 271.1, 271.4, 271.9; D2/610-623; D7/669; D28/63; 2/158-160, 161.1-161.8, 162-170, 2/16-21, 907, 910, 917; 401/6-8; 446/327, 328; 223/78-80; D30/158; D24/190, 200, 214; 119/611; D32/40-43; D21/807; D20/33  
CPC ..... A41D 13/082; A41D 13/088; A41D 13/081; A63B 21/1438; A63B 21/1442; A63B 2244/09; A61F 13/108; A61F 5/013; Y10S 2/91

See application file for complete search history.

(56) **References Cited**

**U.S. PATENT DOCUMENTS**

4,309,991 A \* 1/1982 DeMarco ..... A61F 13/108  
473/62  
RE32,566 E \* 12/1987 Patton, Jr. .... A41D 13/088  
2/16

(57) **CLAIM**

The ornamental design for weight lifting grip with wrist support, as shown and described.

**DESCRIPTION**

FIG. 1 is a top perspective view of a weight lifting grip with wrist support, according to my new design, shown in a position of use;  
FIG. 2 is a side perspective view thereof;  
FIG. 3 is a perspective view of a weight lifting grip with wrist support, shown in an alternate position;  
FIG. 4 is a rear elevational view thereof;  
FIG. 5 is a front elevational view thereof;  
FIG. 6 is a right elevational view thereof;  
FIG. 7 is a left elevational view thereof;  
FIG. 8 is a top elevational view thereof; and,  
FIG. 9 is a bottom elevational view thereof.  
The broken lines shown in FIGS. 1 and 2 are included for the purpose of illustrating environment that forms no part of the claimed design. The broken lines shown in FIG. 9 are included for the purpose of illustrating portions of the weight lifting grip with wrist support that form no part of the claimed design.

**1 Claim, 7 Drawing Sheets**

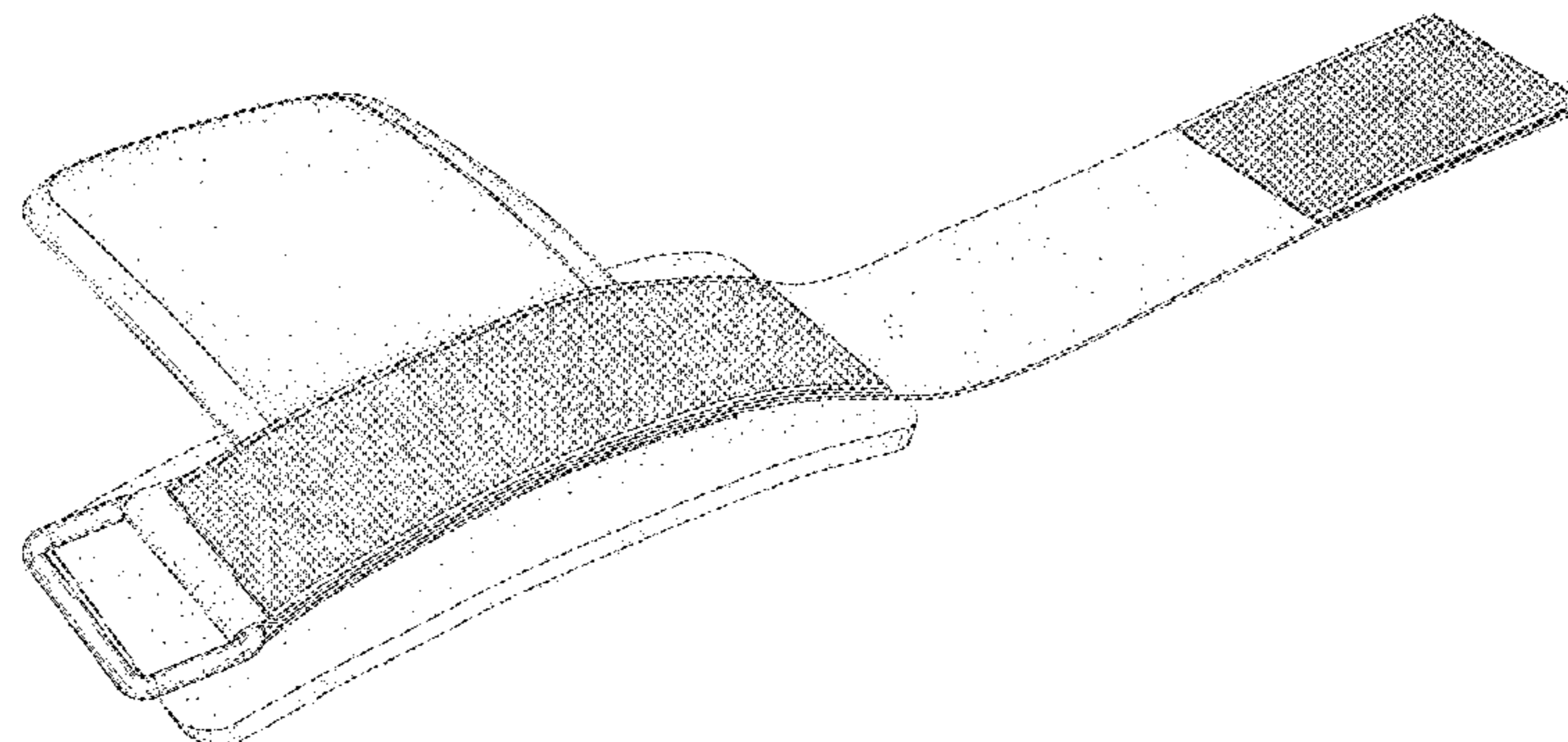

(56)

**References Cited**

U.S. PATENT DOCUMENTS

D363,146	S *	10/1995	Pando	.....	D29/113
5,479,660	A *	1/1996	Najac	.....	A41D 13/082 2/161.1
D368,351	S *	4/1996	Yewer, Jr.	.....	D29/113
5,600,853	A *	2/1997	Yewer, Jr.	.....	A41D 13/082 2/161.1
D380,874	S *	7/1997	Caswell	.....	D2/617
D387,503	S *	12/1997	Ho	.....	D2/610
5,781,928	A *	7/1998	Avila	.....	A41D 13/081 2/159
5,933,868	A *	8/1999	Bender	.....	A41D 13/088 2/16
D429,880	S *	8/2000	McCullough, Jr.	.....	D3/215
D581,539	S *	11/2008	Rotter	.....	D24/190
8,096,901	B2 *	1/2012	Russotti	.....	A63B 9/0071 2/161.1
D662,557	S *	6/2012	Nawracaj	.....	D21/683
D723,224	S *	2/2015	Smith	.....	D29/123
2014/0213420	A1 *	7/2014	Harris	.....	A63B 71/14 482/93
2015/0052655	A1 *	2/2015	McCully	.....	A63B 71/14 2/16

OTHER PUBLICATIONS

Versa Gripps Pro, available Apr. 5, 2008, [online], [site visited Sep. 15, 2015]. Available from internet, <URL: [http://www.amazon.com/gp/product/B002Y2S6K8?gwSec=1&redirect=true&ref\\_=s9\\_simh\\_gw\\_p200\\_d0\\_i3](http://www.amazon.com/gp/product/B002Y2S6K8?gwSec=1&redirect=true&ref_=s9_simh_gw_p200_d0_i3)>.\*

Weight Lifting Gloves—Crown Gear, available Mar. 26, 2015, [online], [site visited Sep. 15, 2015]. Available from internet, <URL: [http://www.amazon.com/gp/product/B00TWMN91Y?gwSec=1&redirect=true&ref\\_=s9\\_simh\\_gw\\_p200\\_d0\\_i12](http://www.amazon.com/gp/product/B00TWMN91Y?gwSec=1&redirect=true&ref_=s9_simh_gw_p200_d0_i12)>.\*

USA Lifting Power Weight Lifting Hooks, available Jun. 20, 2015, [online], [site visited Sep. 15, 2015]. Available from internet, <URL: [http://www.amazon.com/gp/product/B00YDNVRCK?gwSec=1&redirect=true&ref\\_=s9\\_simh\\_gw\\_p200\\_d0\\_i27](http://www.amazon.com/gp/product/B00YDNVRCK?gwSec=1&redirect=true&ref_=s9_simh_gw_p200_d0_i27)>.\*

\* cited by examiner



FIG. 1

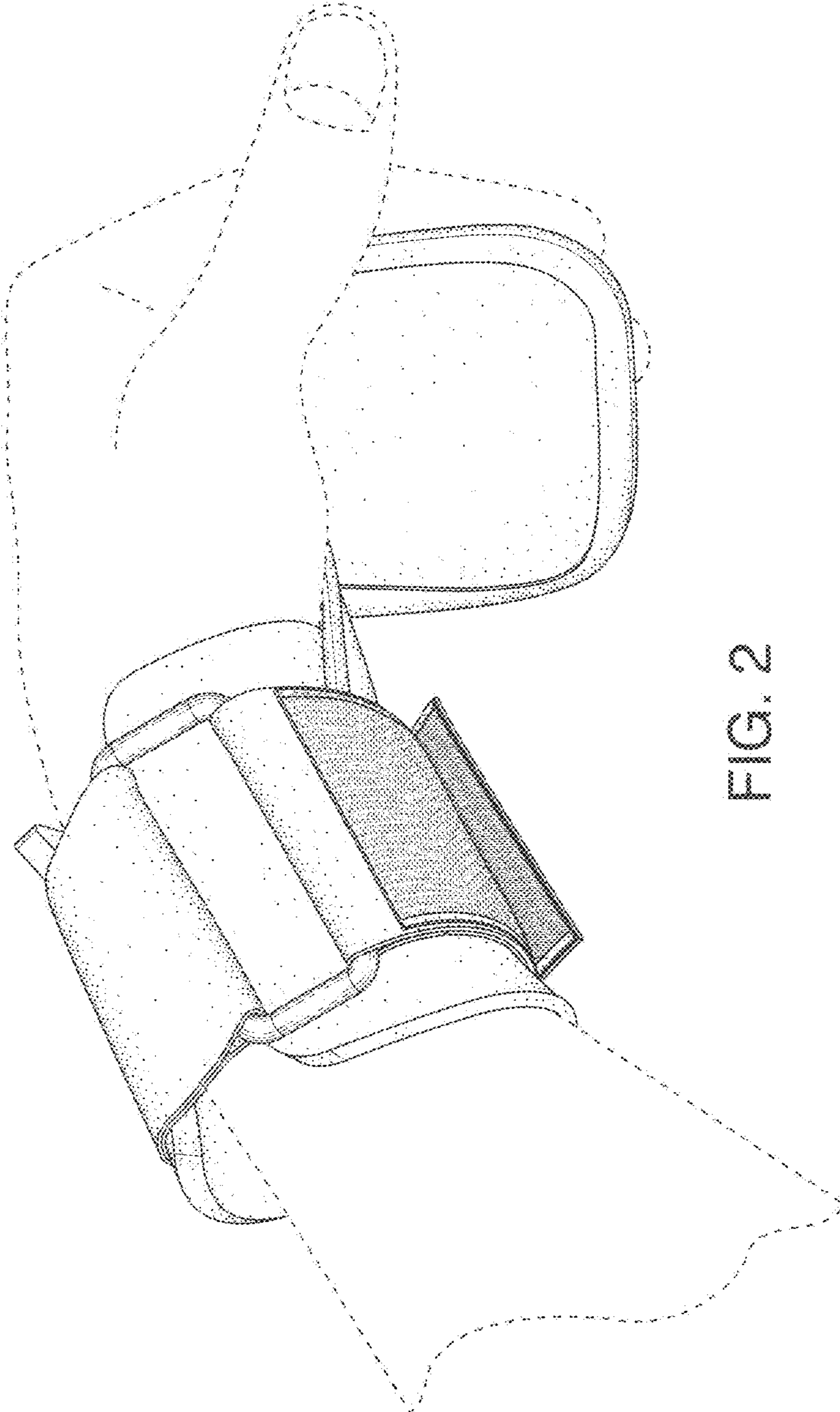

FIG. 2

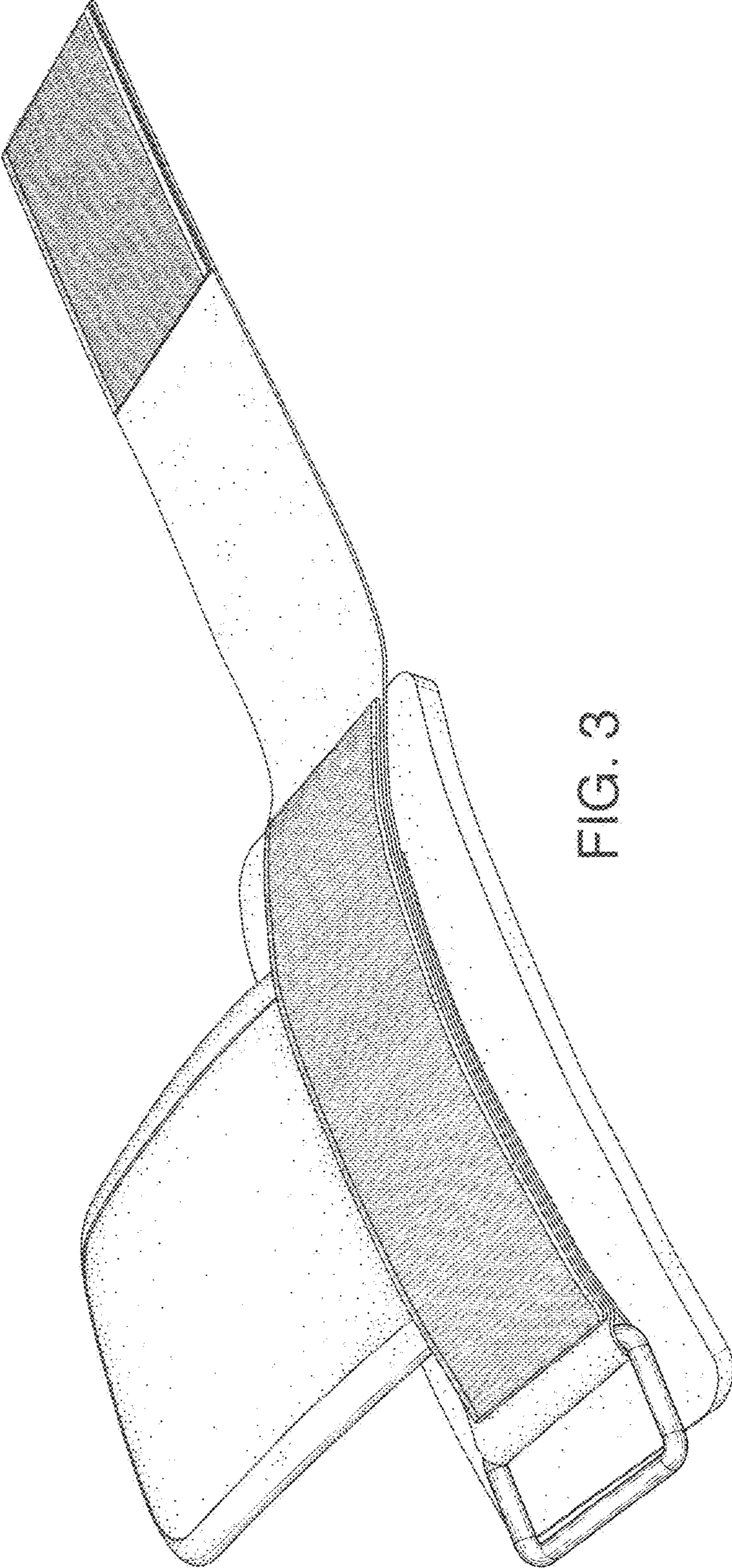

FIG. 3

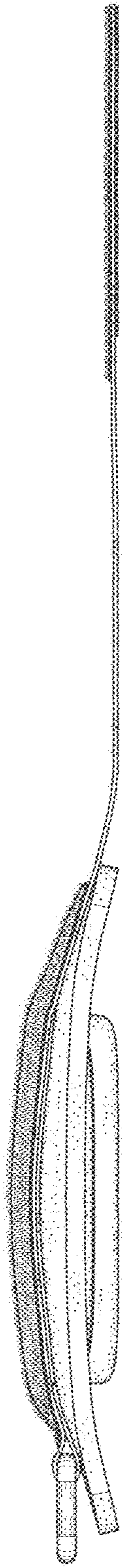

FIG. 4

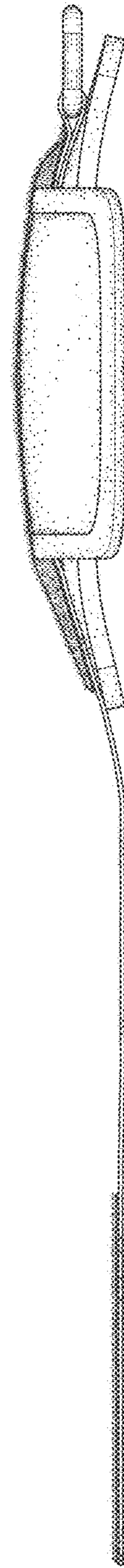

FIG. 5

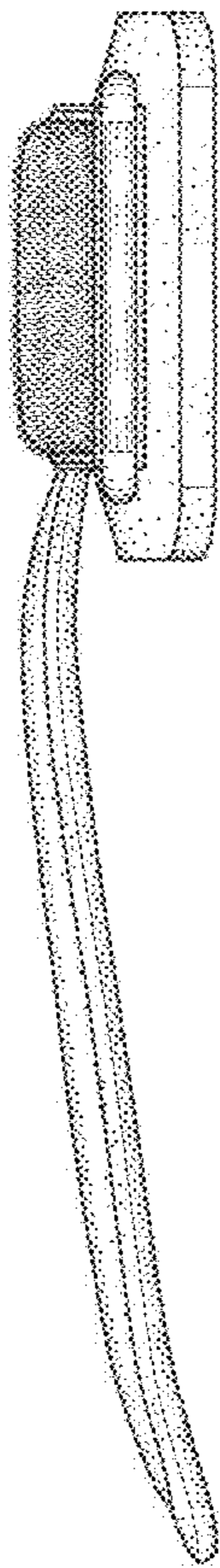

FIG. 6

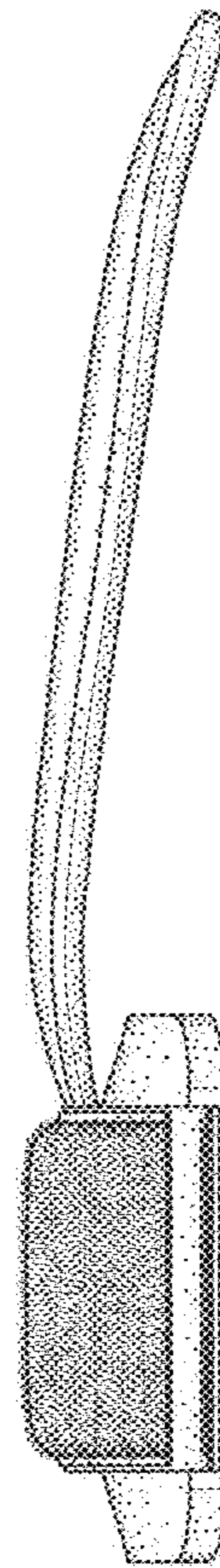

FIG. 7

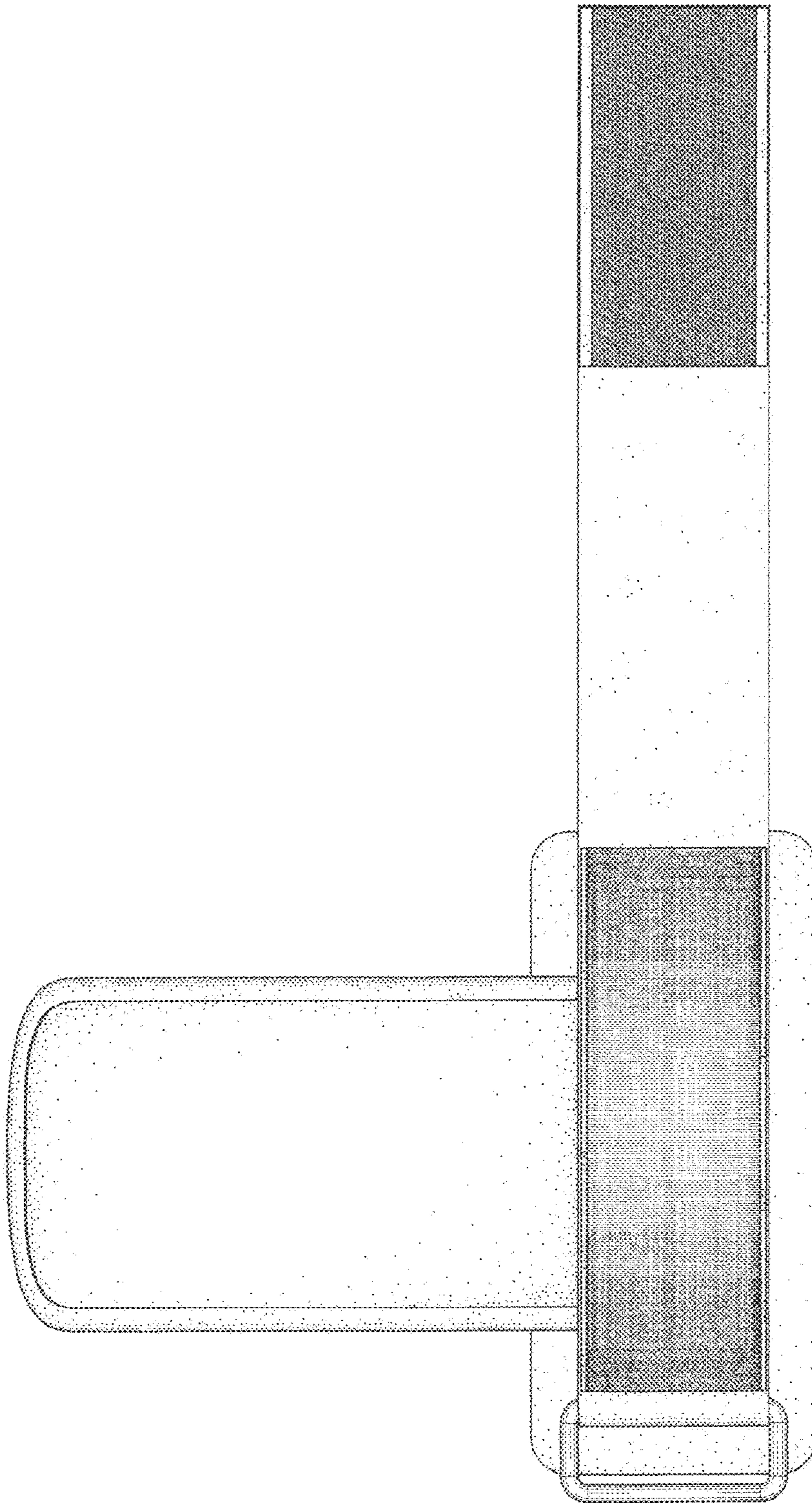

FIG. 8



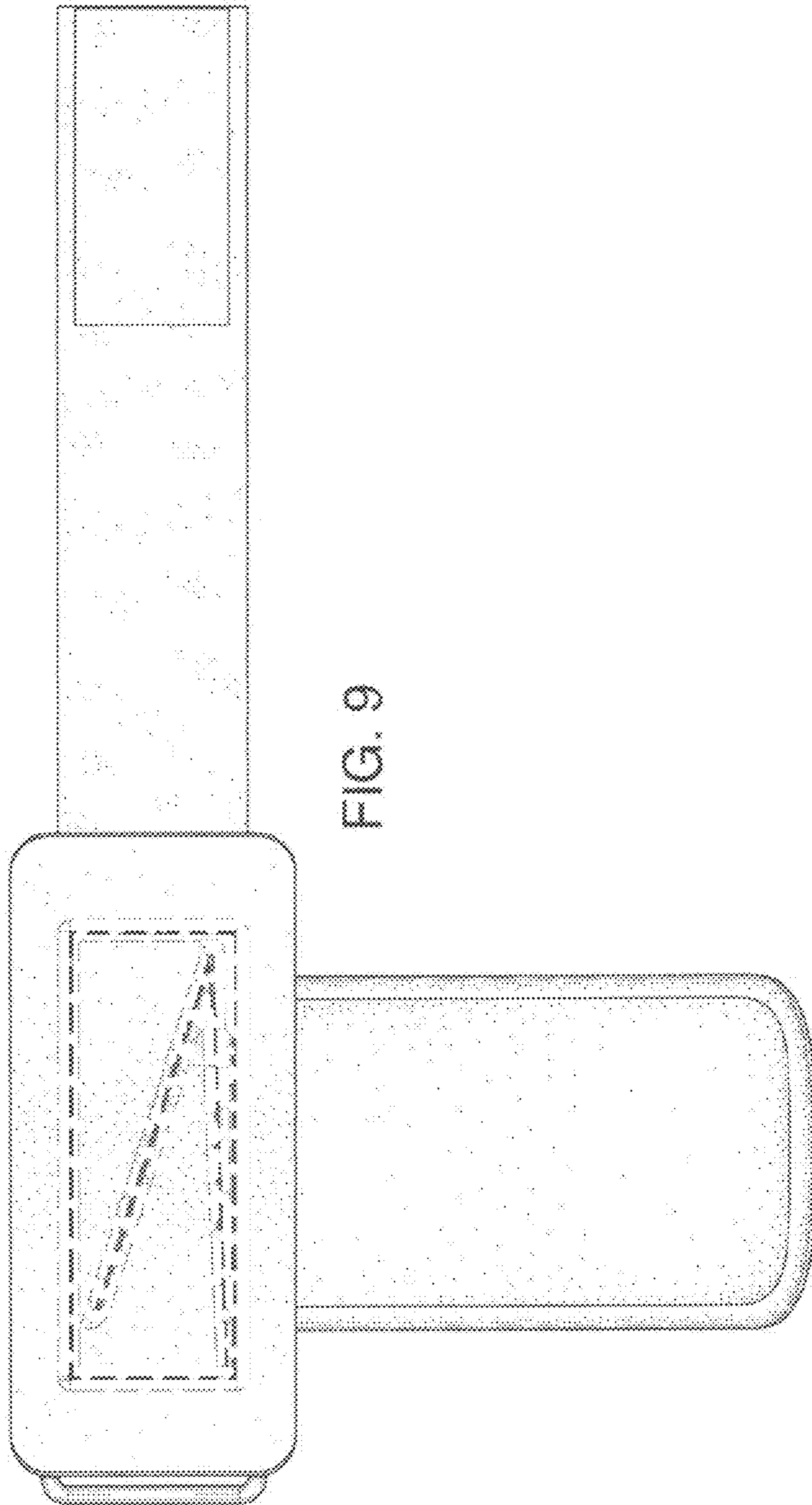

FIG. 9