



US00D769533S

(12) **United States Design Patent** (10) **Patent No.:** **US D769,533 S**
Teller et al. (45) **Date of Patent:** **** *Oct. 18, 2016**

(54) **COSMETIC PRODUCT CONTAINER**

(71) Applicant: **EOS PRODUCTS, LLC**, New York, NY (US)
(72) Inventors: **Jonathan Teller**, New York, NY (US); **Sanjiv Mehra**, New York, NY (US); **Peter Waxman**, New York, NY (US); **Joseph Speter**, New York, NY (US); **Sherry Jhawar**, New York, NY (US); **Hamish Campbell**, New York, NY (US)

(73) Assignee: **EOS PRODUCTS, LLC**, New York, NY (US)

(*) Notice: This patent is subject to a terminal disclaimer.

(**) Term: **14 Years**

(21) Appl. No.: **29/488,850**

(22) Filed: **Apr. 23, 2014**

(51) **LOC (10) Cl.** **28-03**

(52) **U.S. Cl.**
USPC **D28/82; D28/88; D9/519; D9/551; D9/556**

(58) **Field of Classification Search**
USPC D28/85-91, 82, 76-79, 4-7, 8.1, 8.2, 9; D9/502, 570, 503, 504, 519, 552, 554, D9/557, 564, 566, 567, 600, 726, 601, 551, D9/521, 416, 529, 438, 435, 556; D24/101, 102; D1/127, 130; D5/43, D5/44, 56, 59, 60, 62, 55; 132/316, 317, 132/318, 320; 206/581, 823, 385; D3/265, D3/270, 271.1; 424/467; D14/489
CPC B65D 1/00; B65D 3/00; B65D 5/00; B65D 11/00; B65D 25/00; B65D 81/00
See application file for complete search history.

(56) **References Cited**

U.S. PATENT DOCUMENTS

1,852,455 A	4/1932	Friedman	
2,745,642 A *	5/1956	Dick	A47J 43/24 206/1.5
3,167,079 A *	1/1965	Weil	B08B 3/044 134/135
D206,463 S *	12/1966	George	D9/502
5,044,496 A	9/1991	Tanaka	
D321,129 S *	10/1991	Giuseppe	D23/366
D380,672 S *	7/1997	Rowe	D9/529
D382,207 S *	8/1997	Rowe	D9/570

(Continued)

FOREIGN PATENT DOCUMENTS

JP	1136041 S	3/2002
JP	2001321140 A	11/2004

OTHER PUBLICATIONS

SIPO Office Action issued Jul. 17, 2014 in connection with CN Appl. No. 201080063211.X citing JP 2004-321410A and JP 1136041S.

Primary Examiner — Marianne Pandozzi
Assistant Examiner — Jae Liang
(74) *Attorney, Agent, or Firm* — Martin & Ferraro, LLP

(57) **CLAIM**
The ornamental design of a cosmetic product container, as shown and described.

DESCRIPTION

FIG. 1 is a front elevational view of a cosmetic product container showing my new design; FIG. 2 is a left side elevational view thereof; FIG. 3 is a right side elevational view thereof; FIG. 4 is a rear elevational view thereof; FIG. 5 is a top plan view thereof; and, FIG. 6 is a bottom plan view thereof. The broken lines are included for the purpose of illustrating portions of the cosmetic product container that form no part of the claimed design.

1 Claim, 3 Drawing Sheets

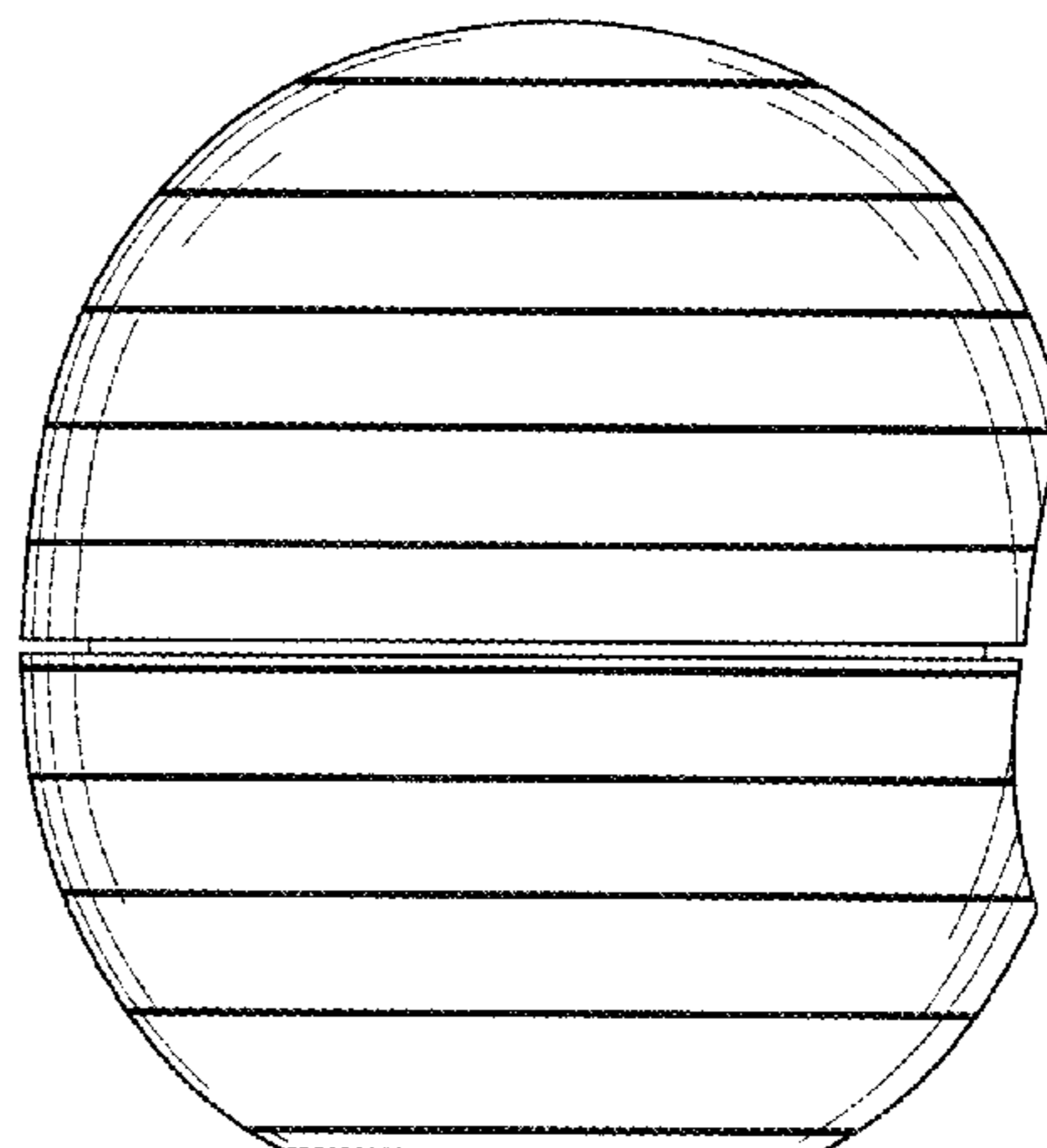
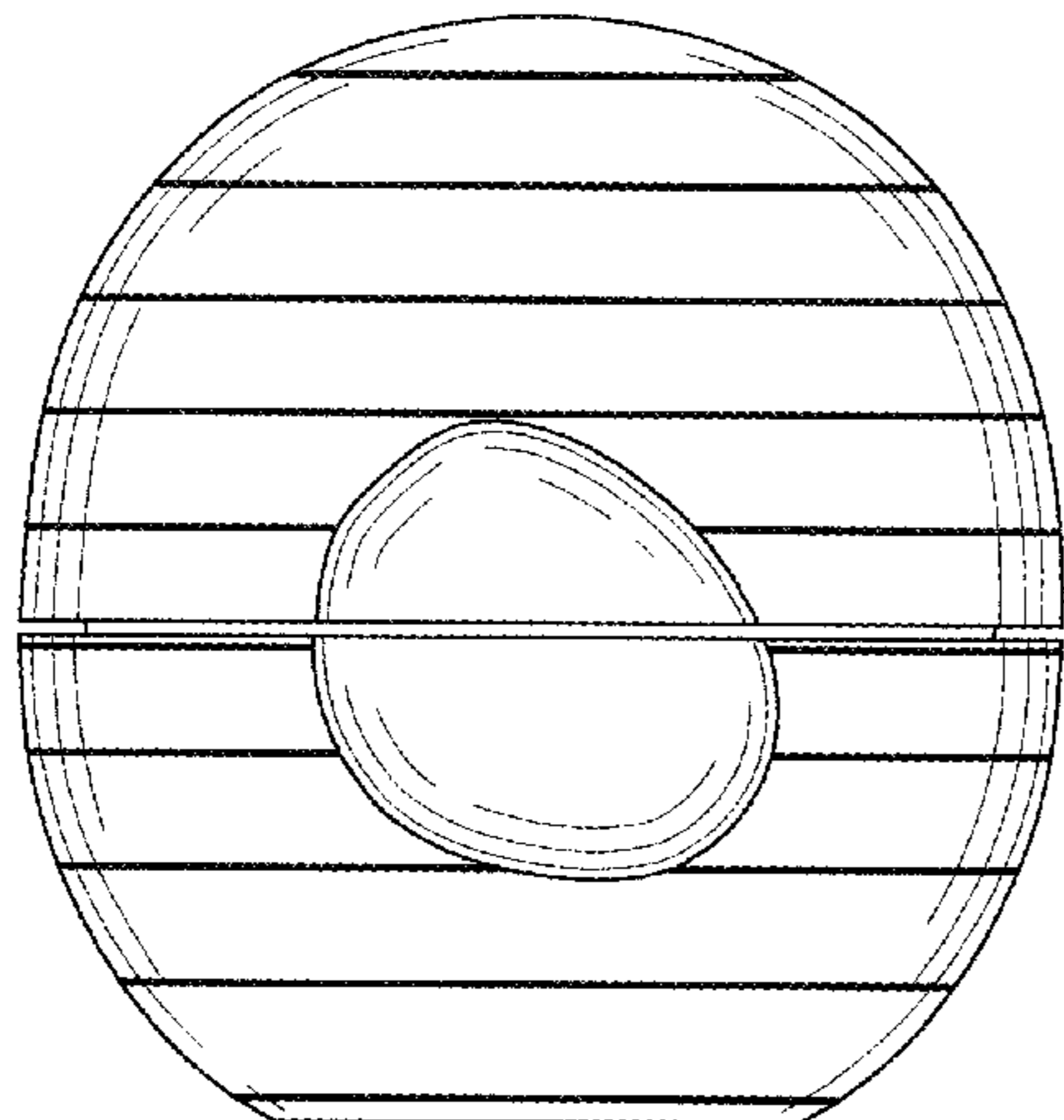

(56)

References Cited

U.S. PATENT DOCUMENTS

6,193,427 B1 2/2001 Benguigui
6,391,972 B1 5/2002 Hatakeyama
D474,021 S * 5/2003 Lenaerts D3/273
D521,868 S * 5/2006 Arima D9/502
D625,469 S * 10/2010 Dubitsky D28/84

D631,204 S * 1/2011 Dubitsky D28/82
D635,371 S * 4/2011 Schilling D21/839
D644,939 S * 9/2011 Teller D9/726
D656,741 S * 4/2012 Snyder D5/60
8,444,337 B2 * 5/2013 Teller A45D 40/00
206/385
D726,219 S * 4/2015 Chaudhri et al. D14/489
D735,414 S * 7/2015 Schlatter D28/85

* cited by examiner

FIG. 1

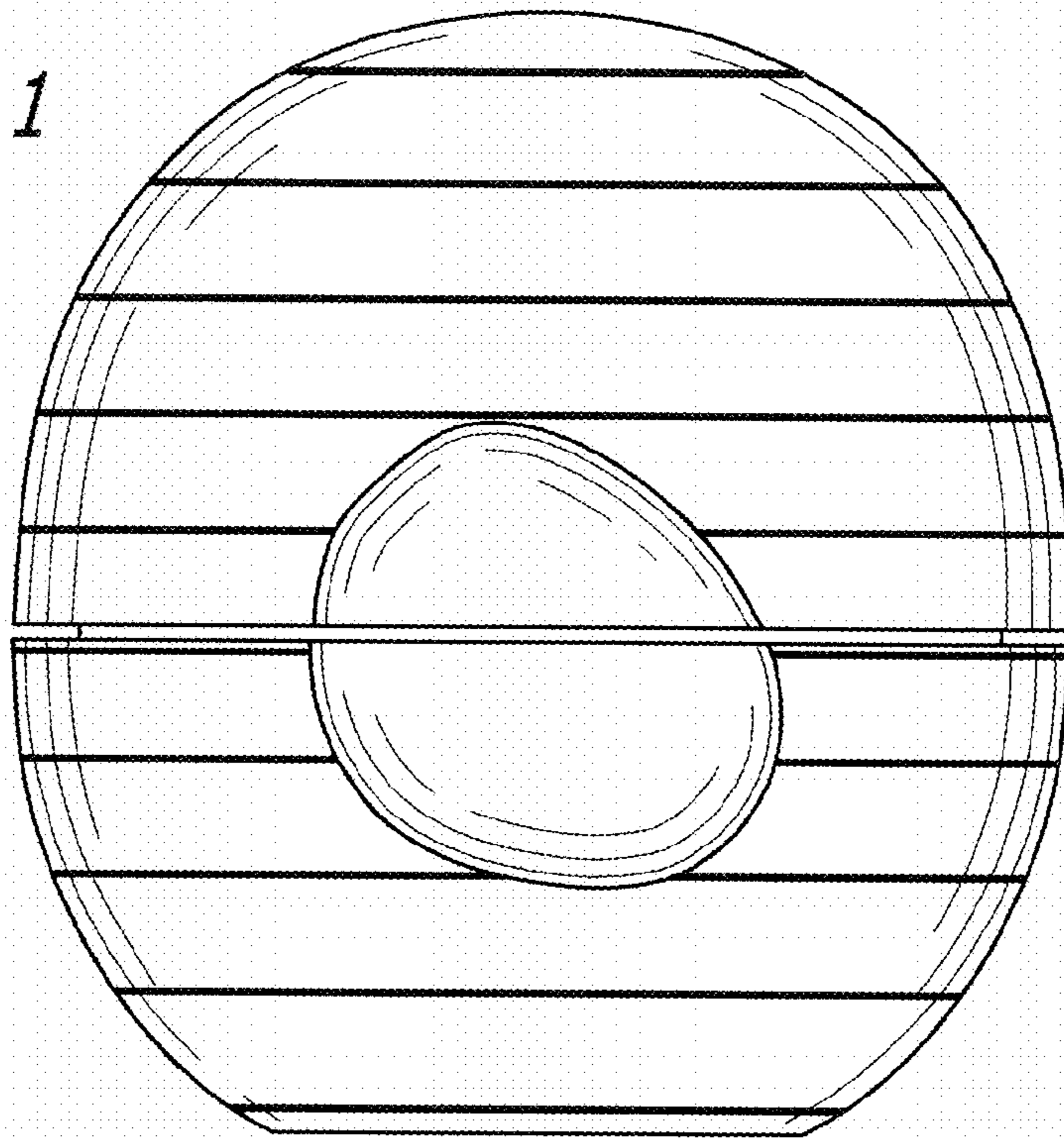

FIG. 2

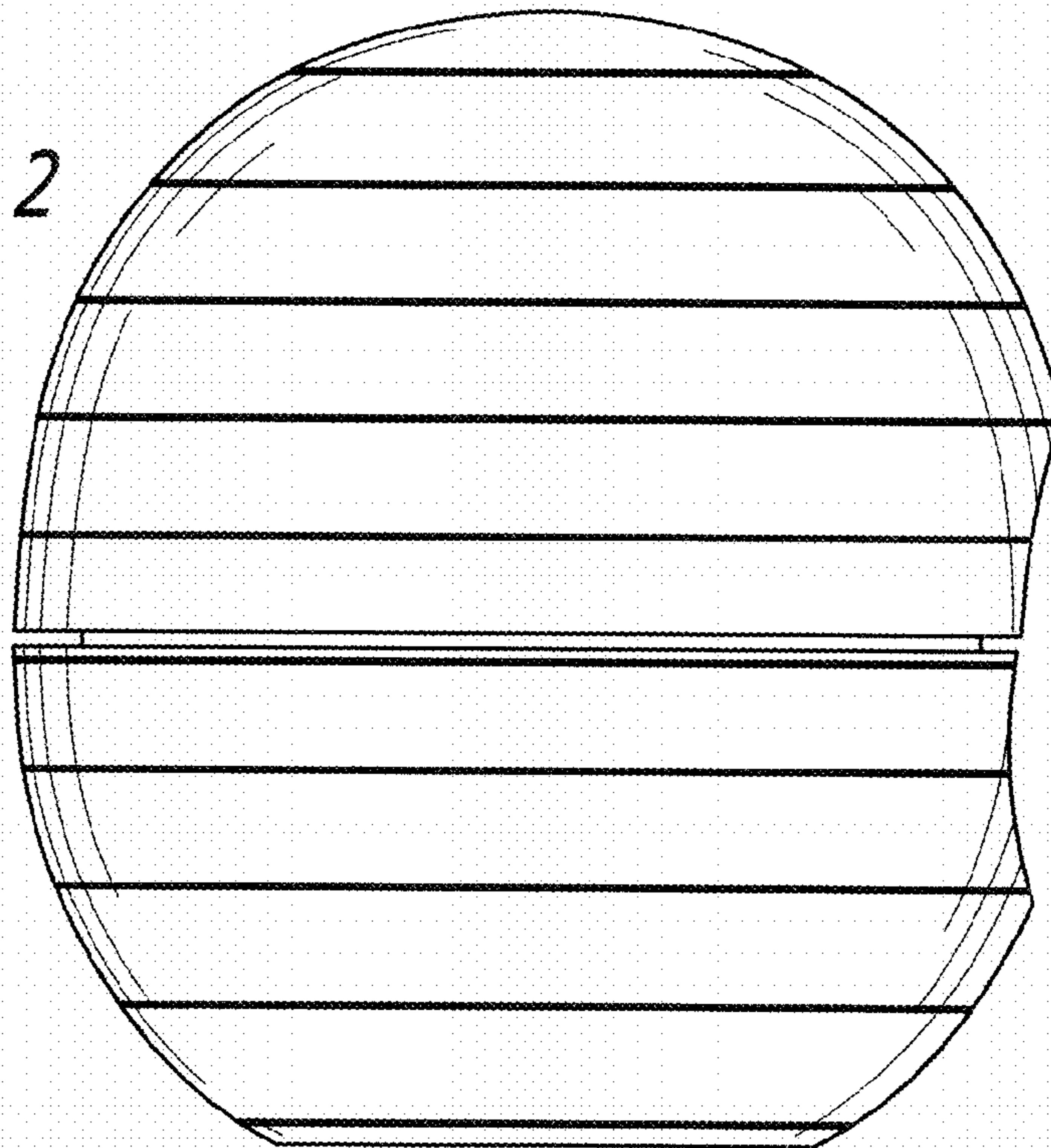

FIG. 3

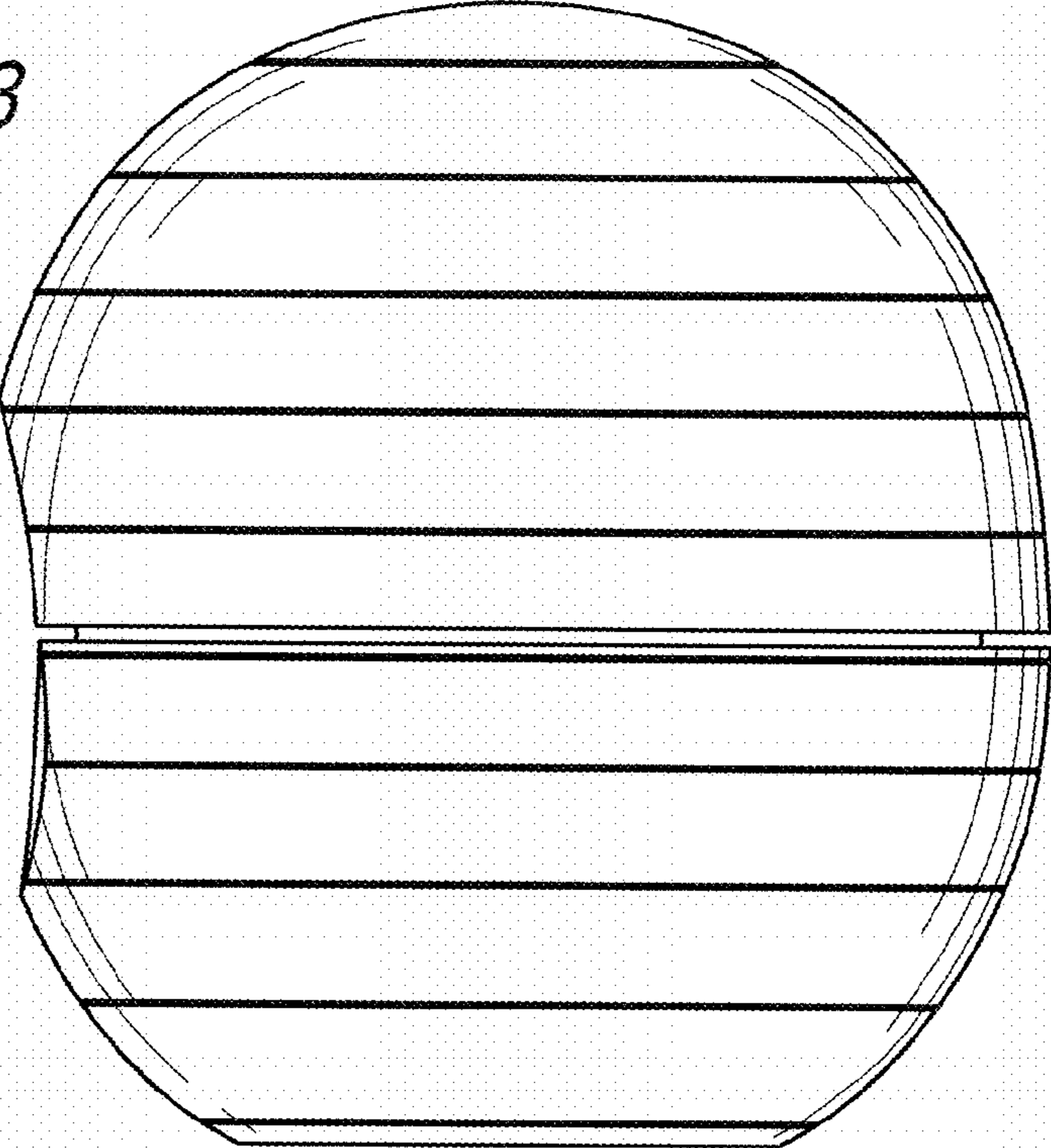

FIG. 4

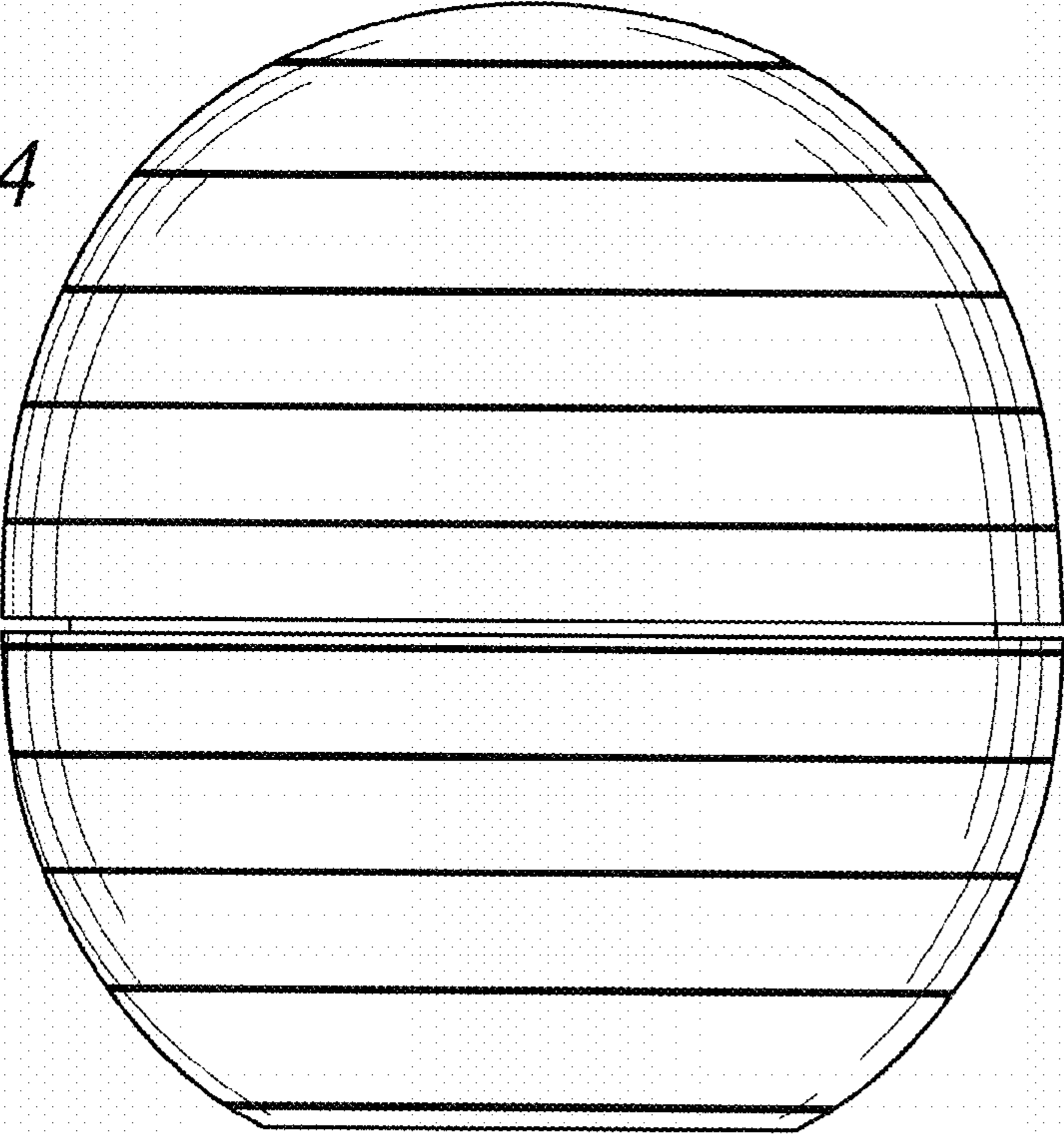

FIG. 5

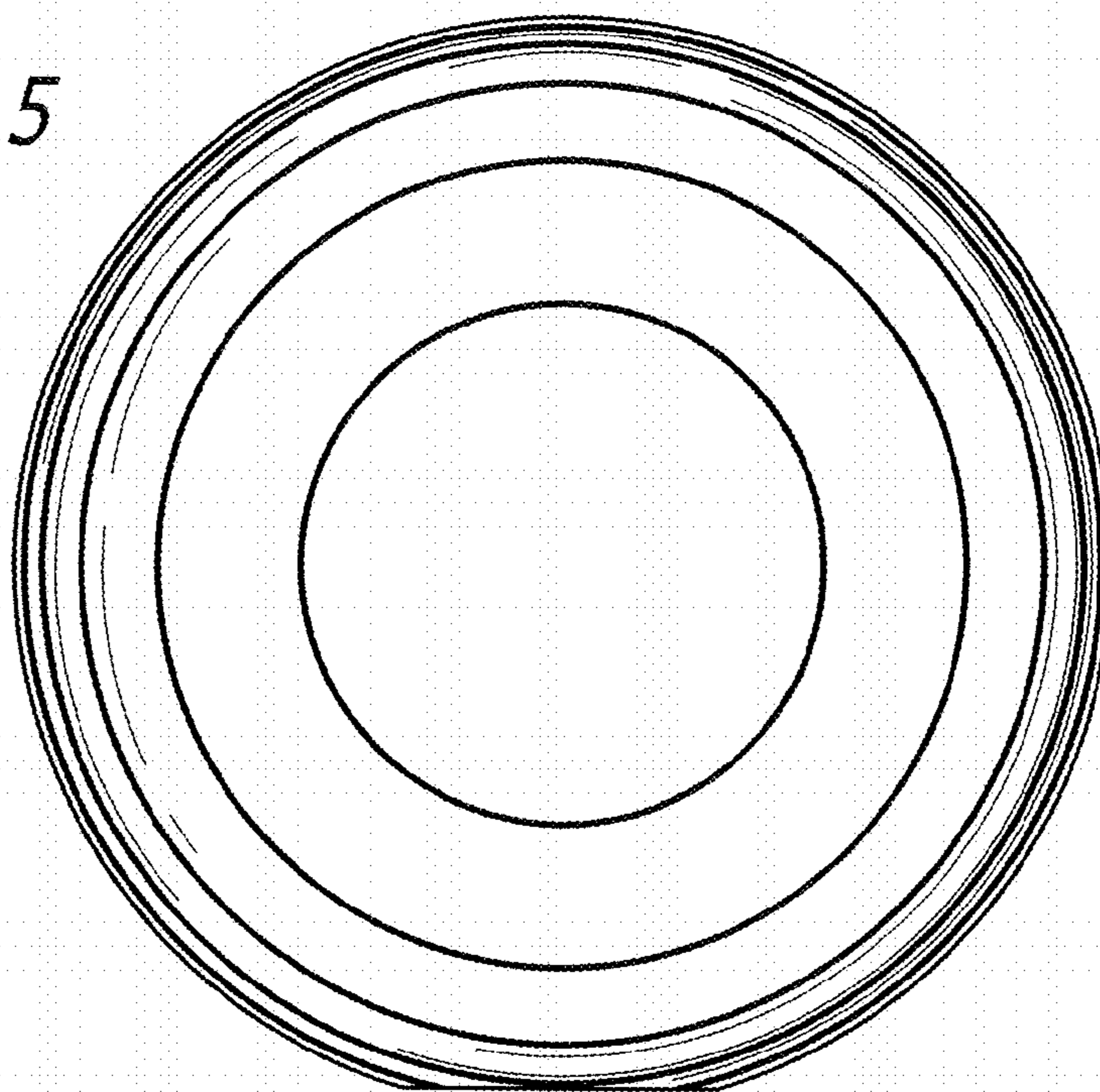

FIG. 6

