



US00D769455S

(12) **United States Design Patent** (10) **Patent No.:** **US D769,455 S**
Sedic (45) **Date of Patent:** **** Oct. 18, 2016**

(54) **SKIN CLEANSER**

2205/082; A61H 2205/085; A61H 15/0085
See application file for complete search history.

(71) Applicant: **Filip Sedic**, Shanghai (CN)

(56) **References Cited**

(72) Inventor: **Filip Sedic**, Shanghai (CN)

U.S. PATENT DOCUMENTS

(**) Term: **15 Years**

(21) Appl. No.: **29/532,908**

(22) Filed: **Jul. 10, 2015**

D351,474 S *	10/1994	Huang	D24/211
D369,220 S *	4/1996	Huang	D24/215
D423,109 S *	4/2000	Allende	D24/215
D466,217 S *	11/2002	Harris	D24/215
D469,183 S *	1/2003	Gerth	D24/200
D476,087 S *	6/2003	Dirks	D24/215
D487,592 S *	3/2004	Chang	D24/215
D517,218 S *	3/2006	Kalen	D24/215
D523,561 S *	6/2006	Telford	D24/215
D539,917 S *	4/2007	Park	D24/215
D548,851 S *	8/2007	Huang	D24/214
D549,351 S *	8/2007	Wu	D24/215
D571,926 S *	6/2008	Wu	D24/215
D574,108 S *	7/2008	Yando	D26/144
D576,736 S *	9/2008	Hagege	D24/215
D622,405 S *	8/2010	Tuli	D24/213
D626,656 S *	11/2010	Jarry	D24/215
D645,569 S *	9/2011	Nitsch	D24/215
D674,108 S *	1/2013	York	D24/215
D698,455 S *	1/2014	Sedic	D24/215
D715,935 S *	10/2014	Huntington	D24/146
D716,961 S *	11/2014	Sedic	D24/215
D734,481 S *	7/2015	Sedic	D24/215

Related U.S. Application Data

(63) Continuation of application No. 29/508,139, filed on Nov. 3, 2014, now Pat. No. Des. 734,481, which is a continuation of application No. 29/480,166, filed on Jan. 23, 2014, now Pat. No. Des. 716,961, which is a continuation of application No. 29/457,890, filed on Jun. 13, 2013, now Pat. No. Des. 698,455.

Foreign Application Priority Data

(30) Jan. 17, 2013 (CN) 2013 3 0013432
Jan. 17, 2013 (CN) 2013 3 0013435

(51) **LOC (10) Cl.** **28-03**

(52) **U.S. Cl.**
USPC **D24/218**

(58) **Field of Classification Search**
USPC D24/200, 211, 212, 213, 214, 215;
601/114, 120, 121, 124, 125, 130, 131,
601/134, 135, 136, 137
CPC A61H 19/30; A61H 19/32; A61H 19/34;
A61H 19/40; A61H 19/44; A61H 19/50;
A61H 19/00; A61H 2201/0153; A61H
2201/0207; A61H 2201/0263; A61H
2201/0111; A61H 2201/1253; A61H

* cited by examiner

Primary Examiner — Sandra Snapp

(74) *Attorney, Agent, or Firm* — Fenwick & West LLP

(57) **CLAIM**

I claim the ornamental design for a skin cleanser, as shown and described.

DESCRIPTION

FIG. 1 is a front view of a first embodiment of a skin cleanser.
FIG. 2 is a right side view of the first embodiment of the skin cleanser.
FIG. 3 is a rear view of the first embodiment of the skin cleanser.

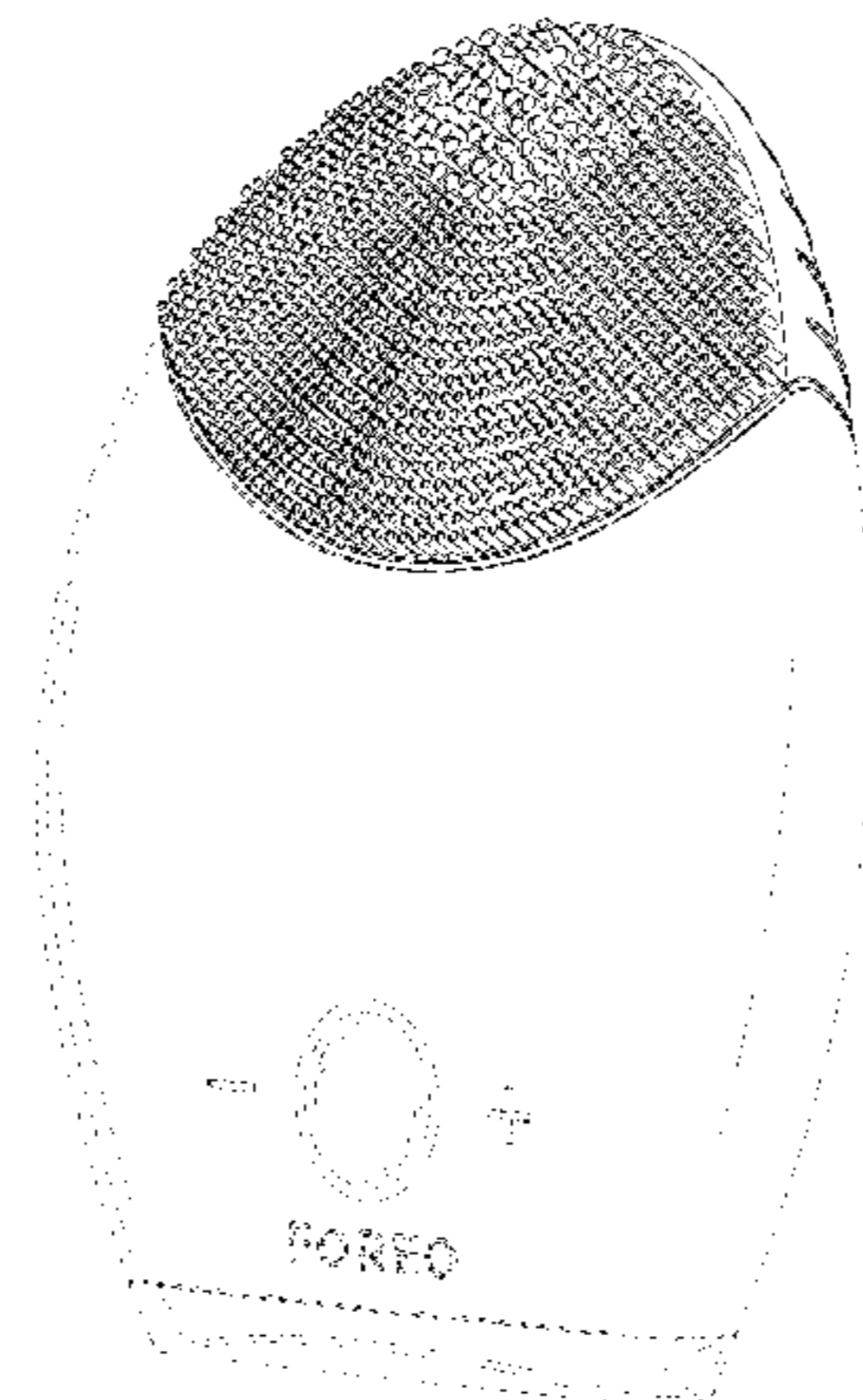

FIG. 4 is a left side view of the first embodiment of the skin cleanser.

FIG. 5 is a top view of the first embodiment of the skin cleanser.

FIG. 6 is a bottom view of the first embodiment of the skin cleanser.

FIGS. 7 and 8 are perspective views of the first embodiment of the skin cleanser.

FIG. 9 is a front view of a second embodiment of the skin cleanser.

FIG. 10 is a right side view of the second embodiment of the skin cleanser.

FIG. 11 is a rear view of the second embodiment of the skin cleanser.

FIG. 12 is a left side view of the second embodiment of the skin cleanser.

FIG. 13 is a top view of the second embodiment of the skin cleanser.

FIG. 14 is a bottom view of the second embodiment of the skin cleanser.

FIGS. 15 and 16 are perspective views of the embodiment of the second skin cleanser.

FIG. 17 is a front view of a third embodiment of the skin cleanser.

FIG. 18 is a right side view of the third embodiment of the skin cleanser.

FIG. 19 is a rear view of the third embodiment of the skin cleanser.

FIG. 20 is a left side view of the third embodiment of the skin cleanser.

FIG. 21 is a top view of the third embodiment of the skin cleanser.

FIG. 22 is a bottom view of the third embodiment of the skin cleanser.

FIGS. 23 and 24 are perspective views of the third embodiment of the skin cleanser.

FIG. 25 is a front view of a fourth embodiment of the skin cleanser.

FIG. 26 is a right side view of the fourth embodiment of the skin cleanser.

FIG. 27 is a rear view of the fourth embodiment of the skin cleanser.

FIG. 28 is a left side view of the fourth embodiment of the skin cleanser.

FIG. 29 is a top view of the fourth embodiment of the skin cleanser.

FIG. 30 is a bottom view of the fourth embodiment of the skin cleanser.

FIGS. 31 and 32 are perspective views of the fourth embodiment of the skin cleanser.

FIG. 33 is a front view of a fifth embodiment of the skin cleanser.

FIG. 34 is a right side view of the fifth embodiment of the skin cleanser.

FIG. 35 is a rear view of the fifth embodiment of the skin cleanser.

FIG. 36 is a left side view of the fifth embodiment of the skin cleanser.

FIG. 37 is a top view of the fifth embodiment of the skin cleanser.

FIG. 38 is a bottom view of the fifth embodiment of the skin cleanser.

FIGS. 39 and 40 are perspective views of the fifth embodiment of the skin cleanser.

FIG. 41 is a front view of a sixth embodiment of a skin cleanser.

FIG. 42 is a right side view of the sixth embodiment of the skin cleanser.

FIG. 43 is a rear view of the sixth embodiment of the skin cleanser.

FIG. 44 is a left side view of the sixth embodiment of the skin cleanser.

FIG. 45 is a top view of the sixth embodiment of the skin cleanser.

FIG. 46 is a bottom view of the sixth embodiment of the skin cleanser.

FIGS. 47 and 48 are perspective views of the sixth embodiment of the skin cleanser.

FIG. 49 is a front view of a seventh embodiment of the skin cleanser.

FIG. 50 is a right side view of the seventh embodiment of the skin cleanser.

FIG. 51 is a rear view of the seventh embodiment of the skin cleanser.

FIG. 52 is a left side view of the seventh embodiment of the skin cleanser.

FIG. 53 is a top view of the seventh embodiment of the skin cleanser.

FIG. 54 is a bottom view of the seventh embodiment of the skin cleanser.

FIGS. 55 and 56 are perspective views of the embodiment of the seventh skin cleanser.

FIG. 57 is a front view of an eighth embodiment of the skin cleanser.

FIG. 58 is a right side view of the eighth embodiment of the skin cleanser.

FIG. 59 is a rear view of the eighth embodiment of the skin cleanser.

FIG. 60 is a left side view of the eighth embodiment of the skin cleanser.

FIG. 61 is a top view of the eighth embodiment of the skin cleanser.

FIG. 62 is a bottom view of the eighth embodiment of the skin cleanser; and,

FIGS. 63 and 64 are perspective views of the eighth embodiment of the skin cleanser.

1 Claim, 56 Drawing Sheets

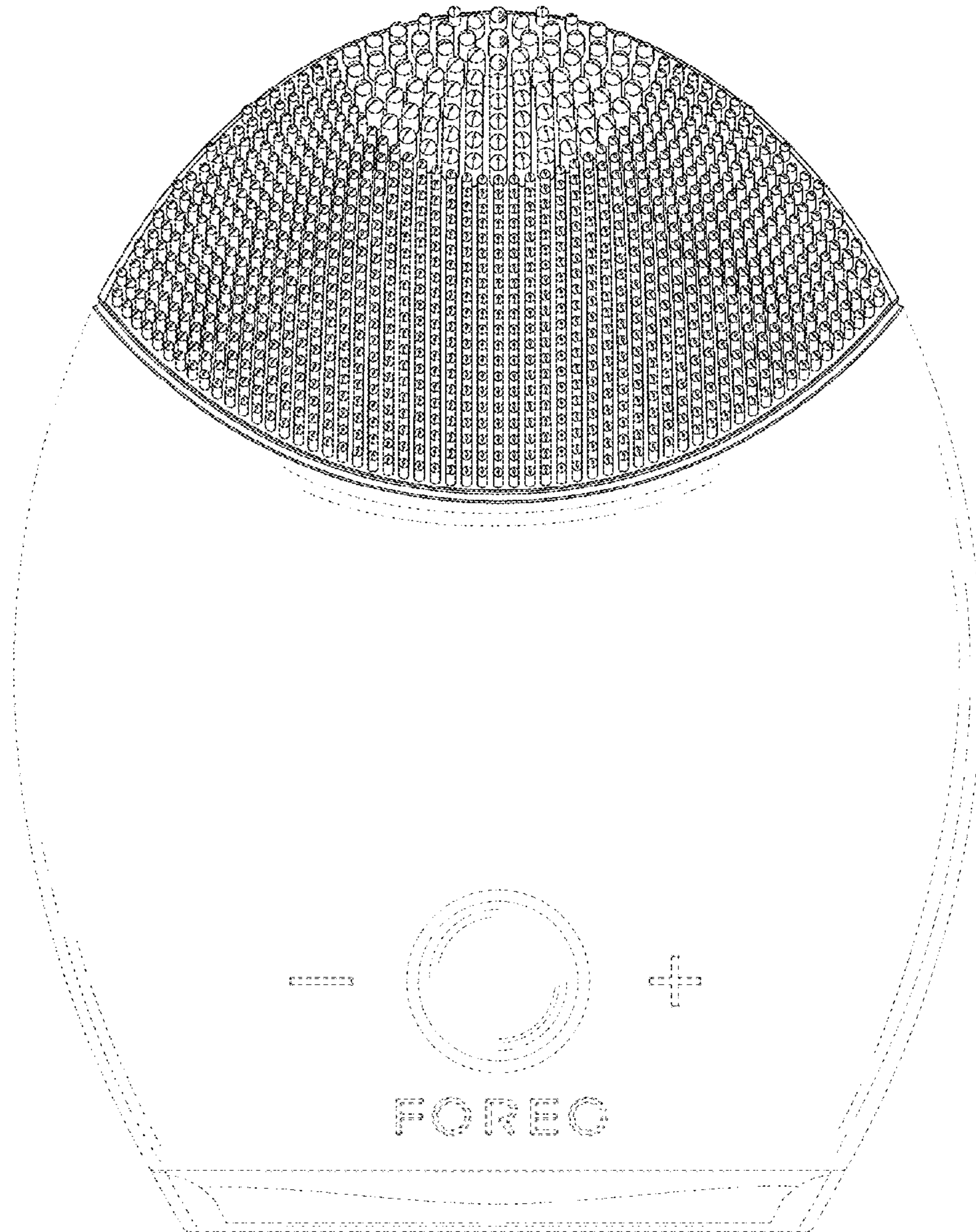

FIG. 1

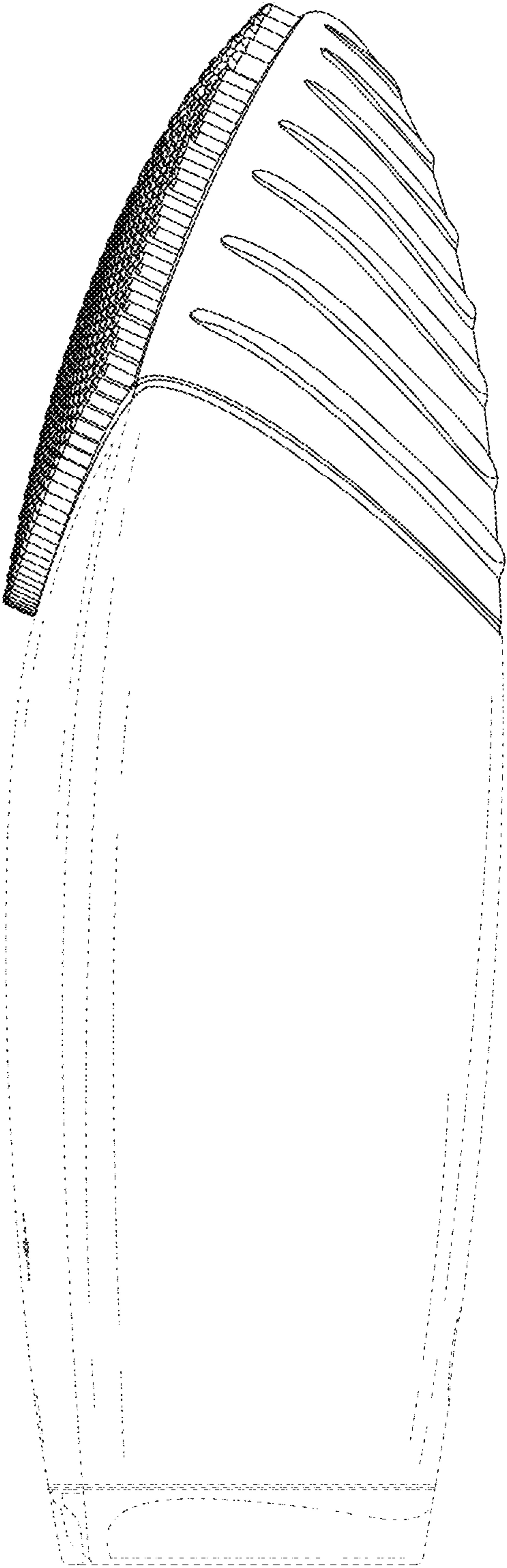

FIG. 2

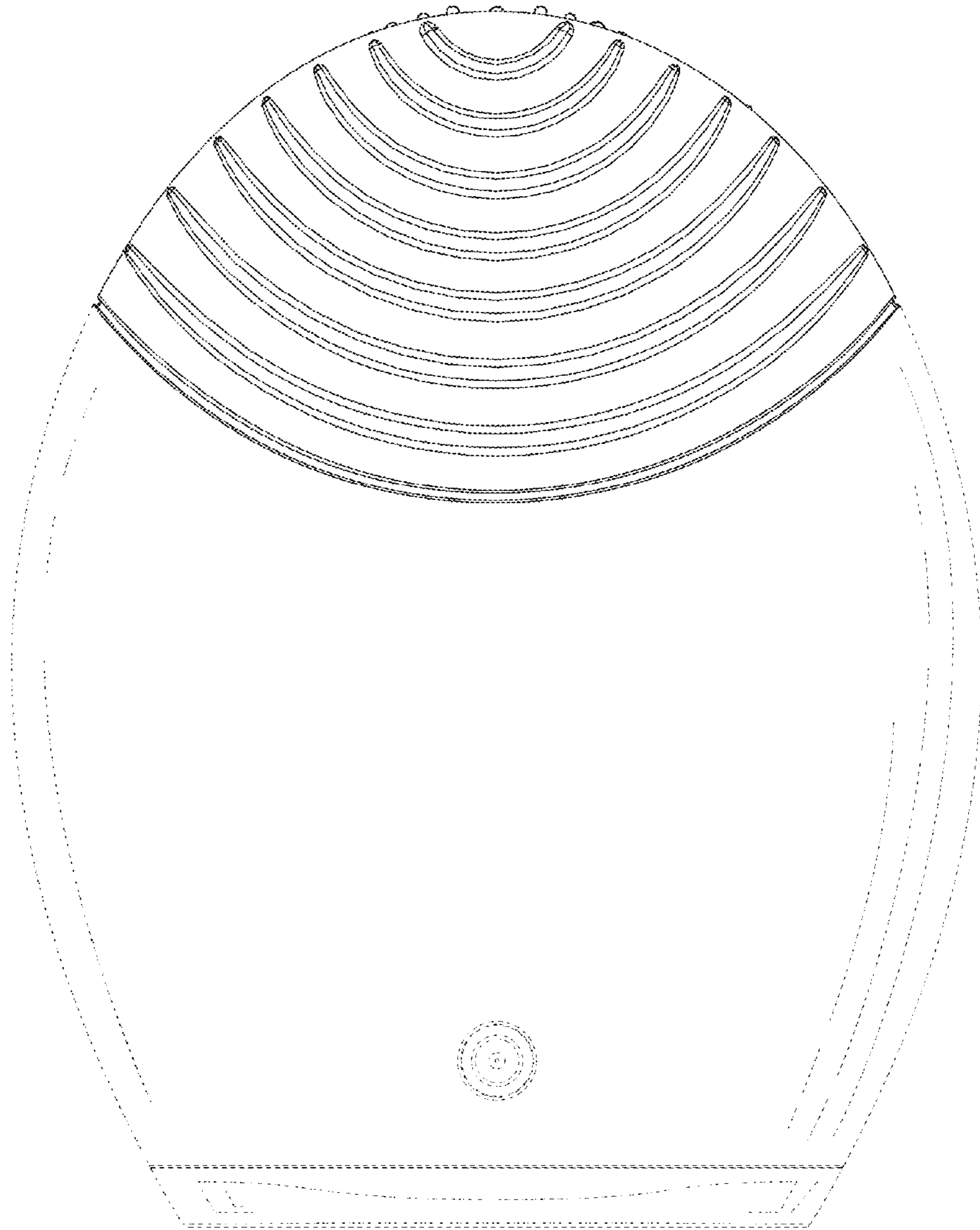

FIG. 3

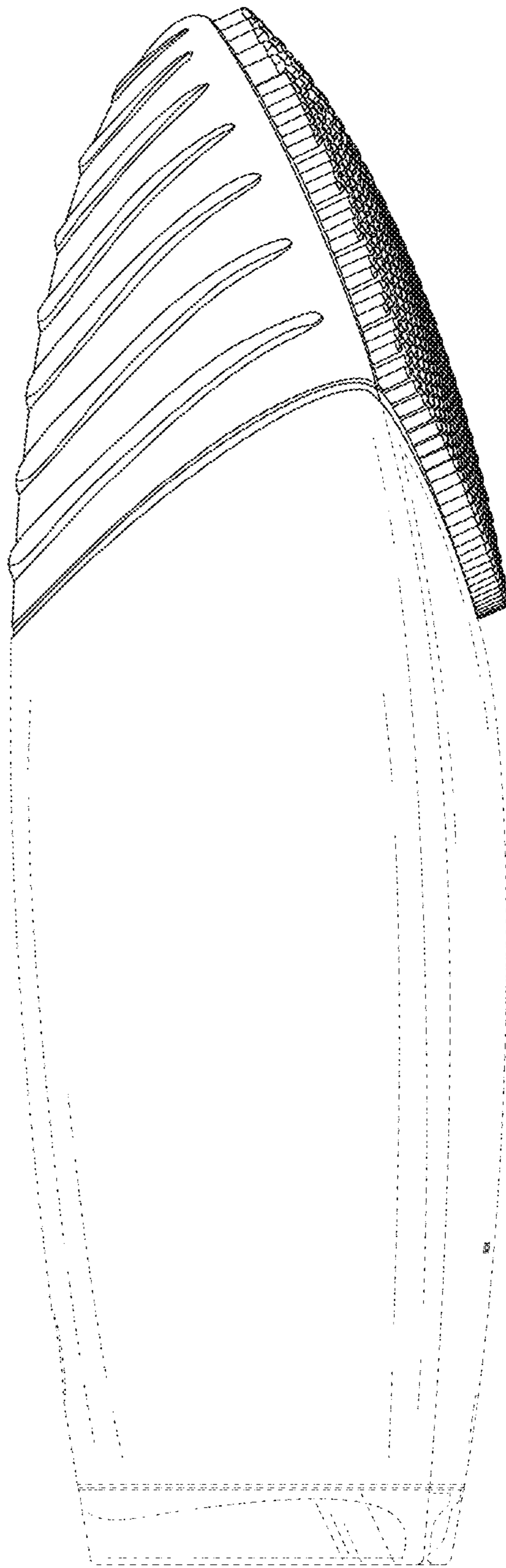

FIG. 4

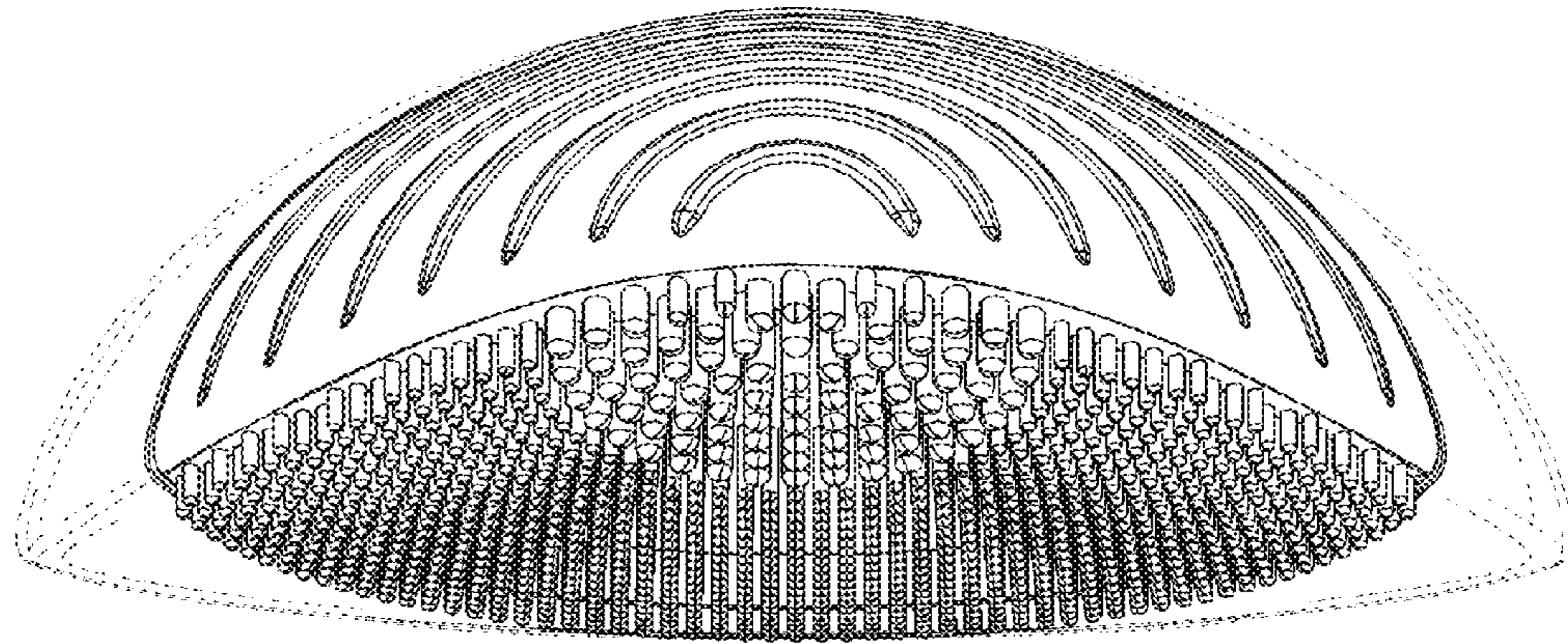

FIG. 5

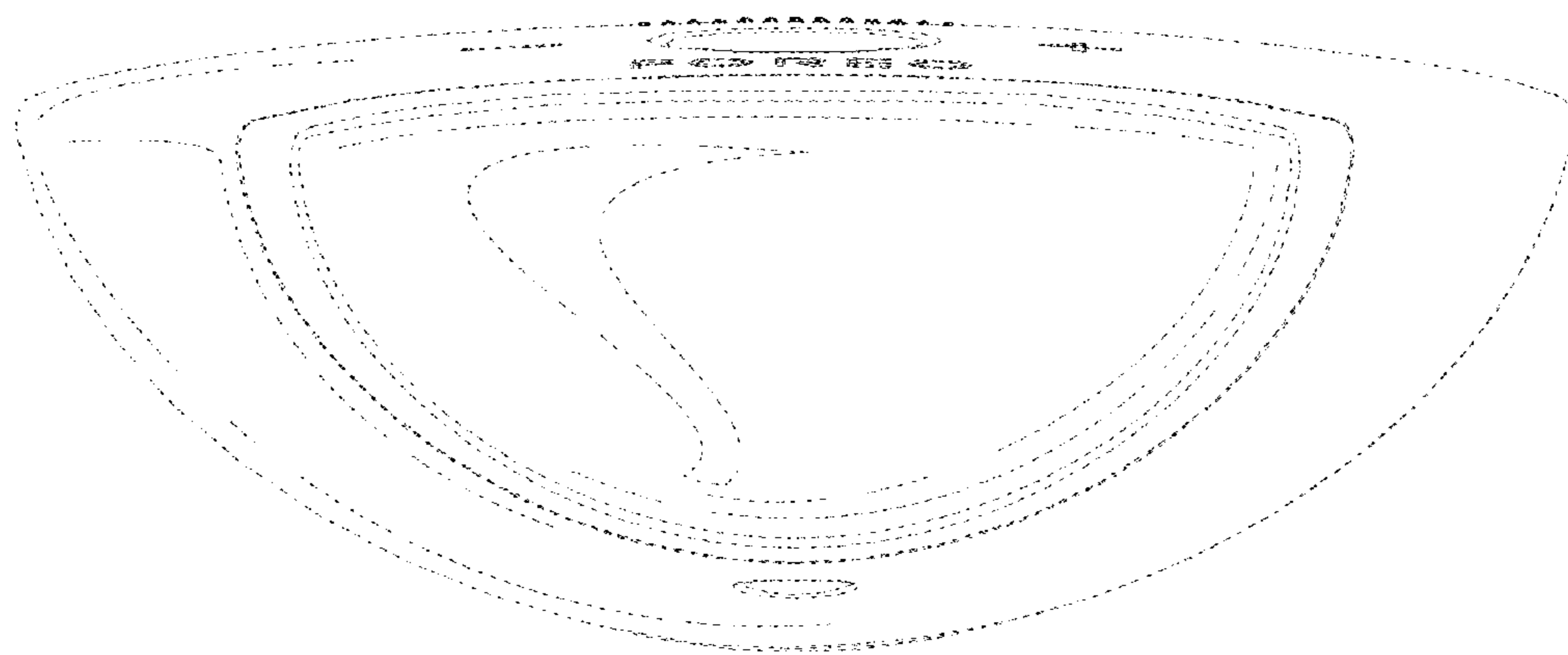

FIG. 6

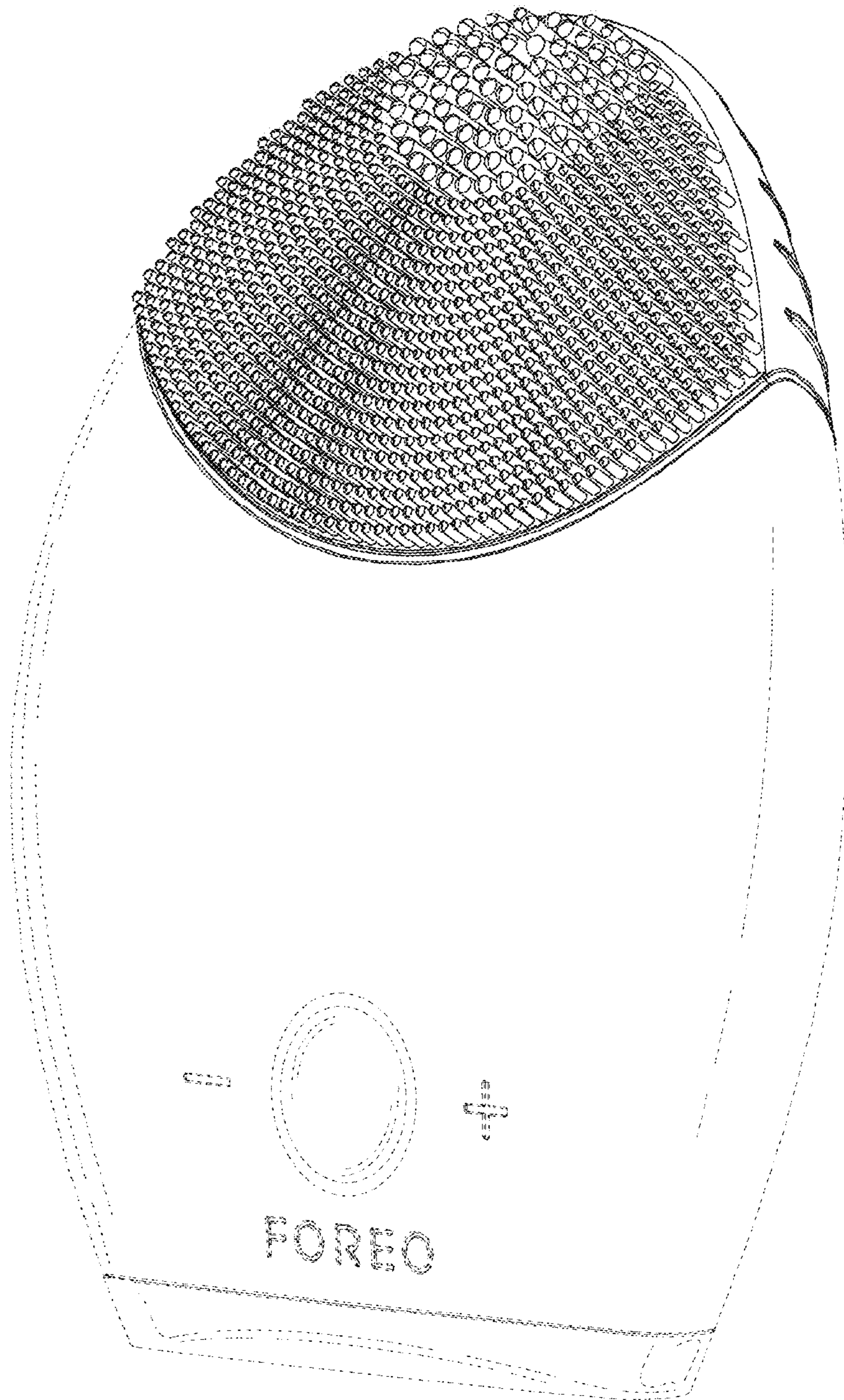

FIG. 7

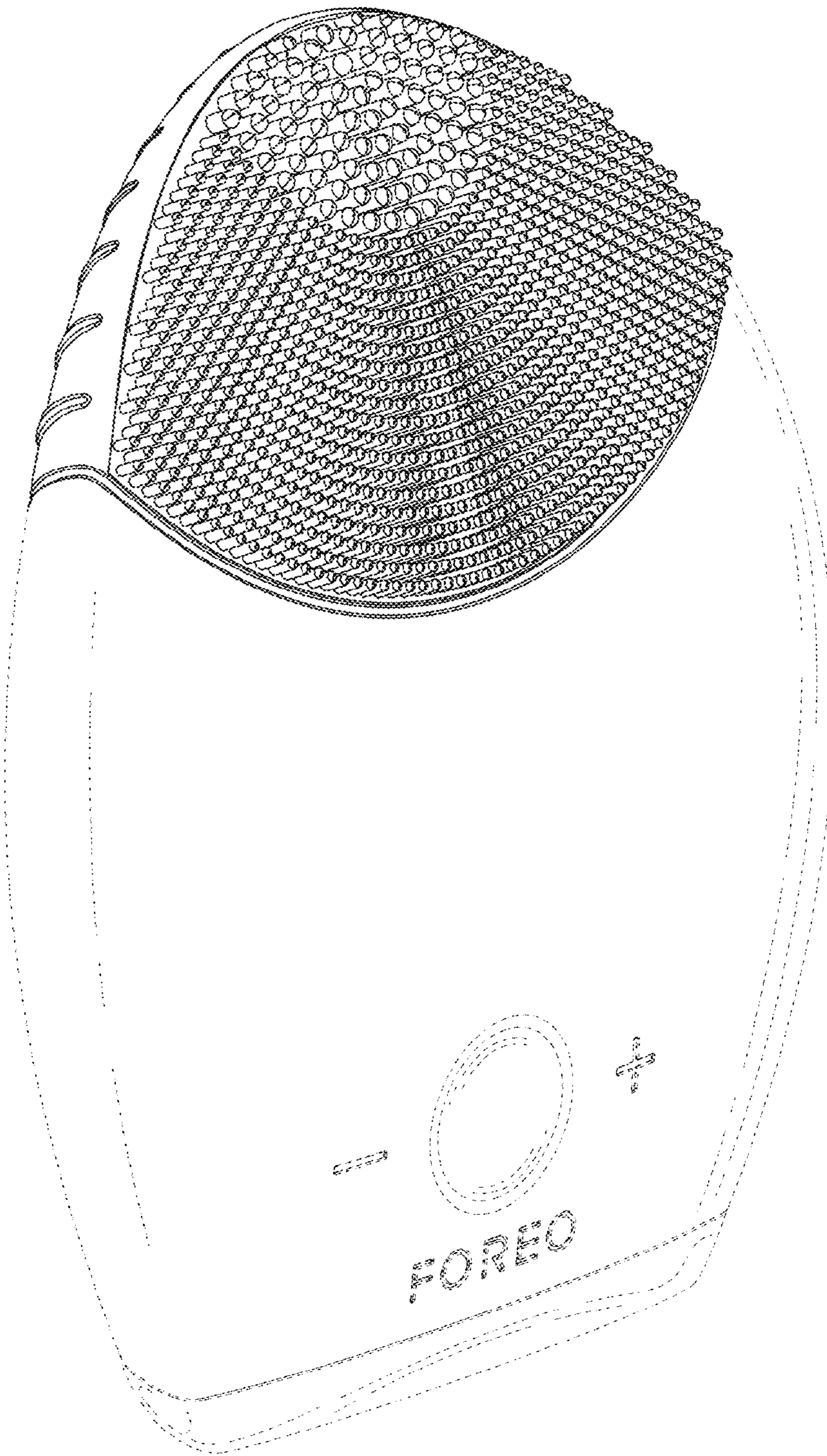

FIG. 8

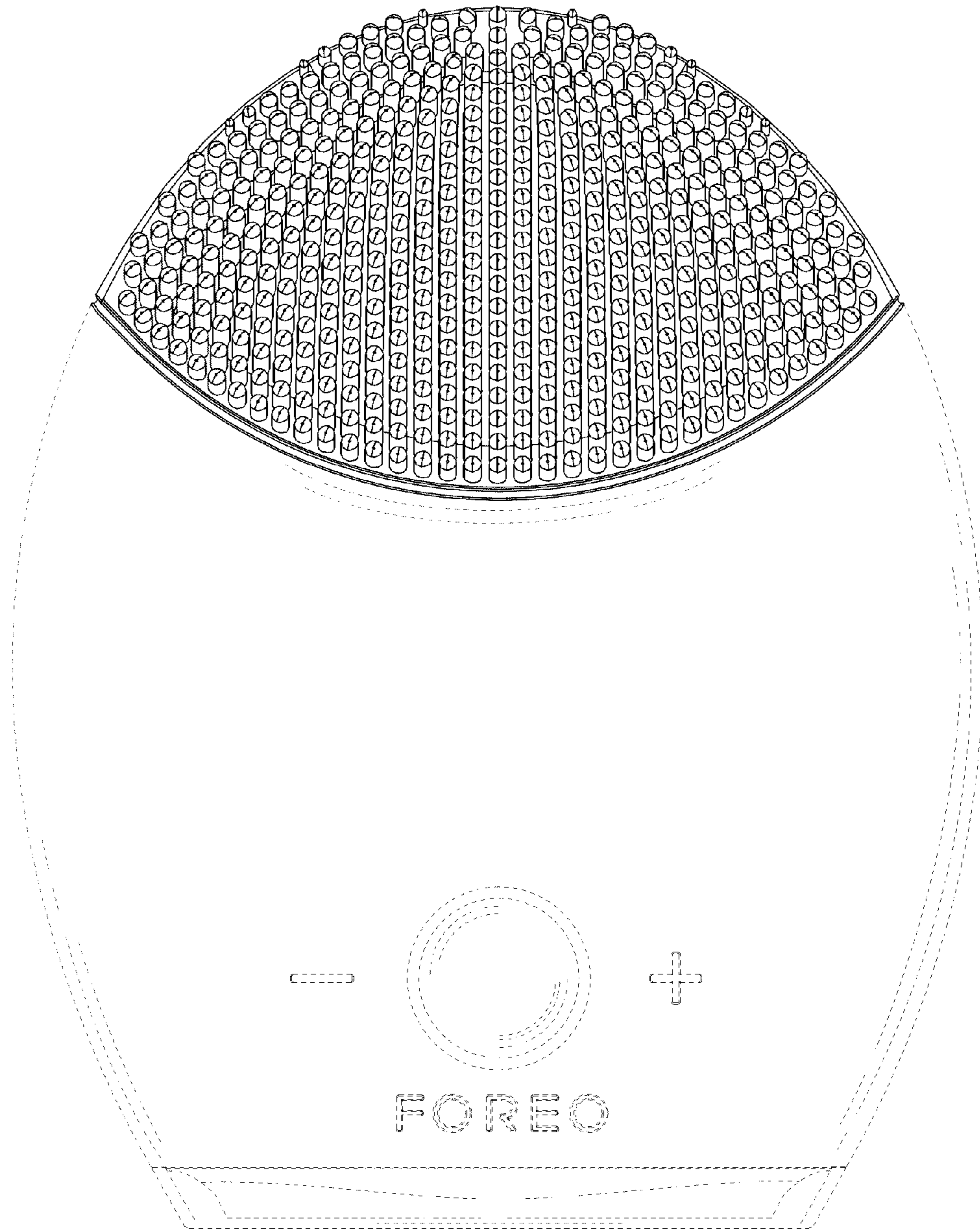

FIG. 9

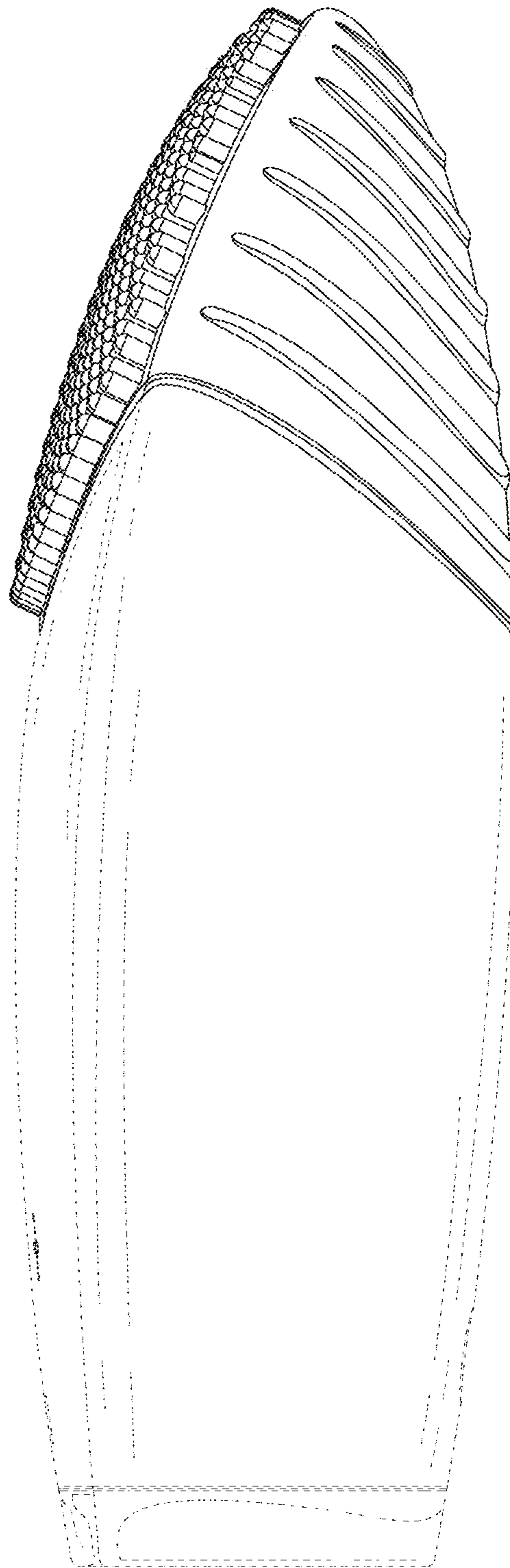

FIG. 10

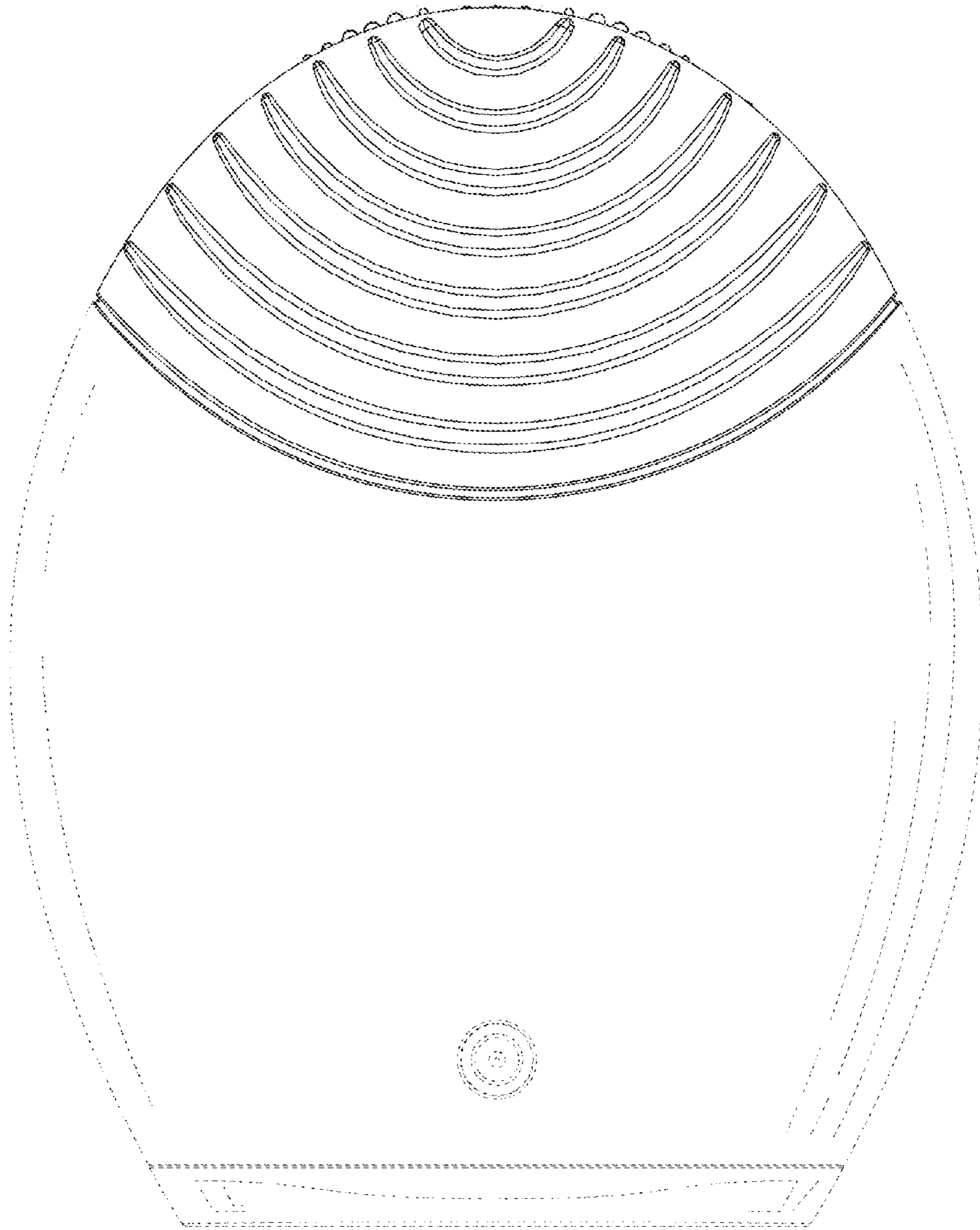

FIG. 11

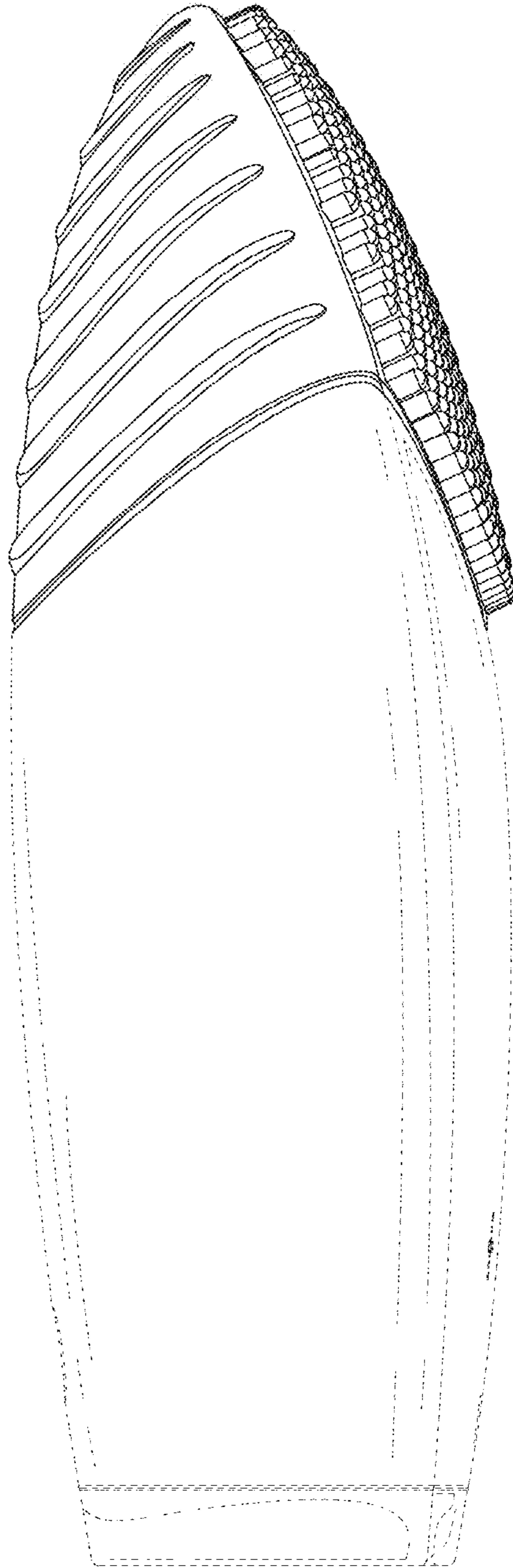

FIG. 12

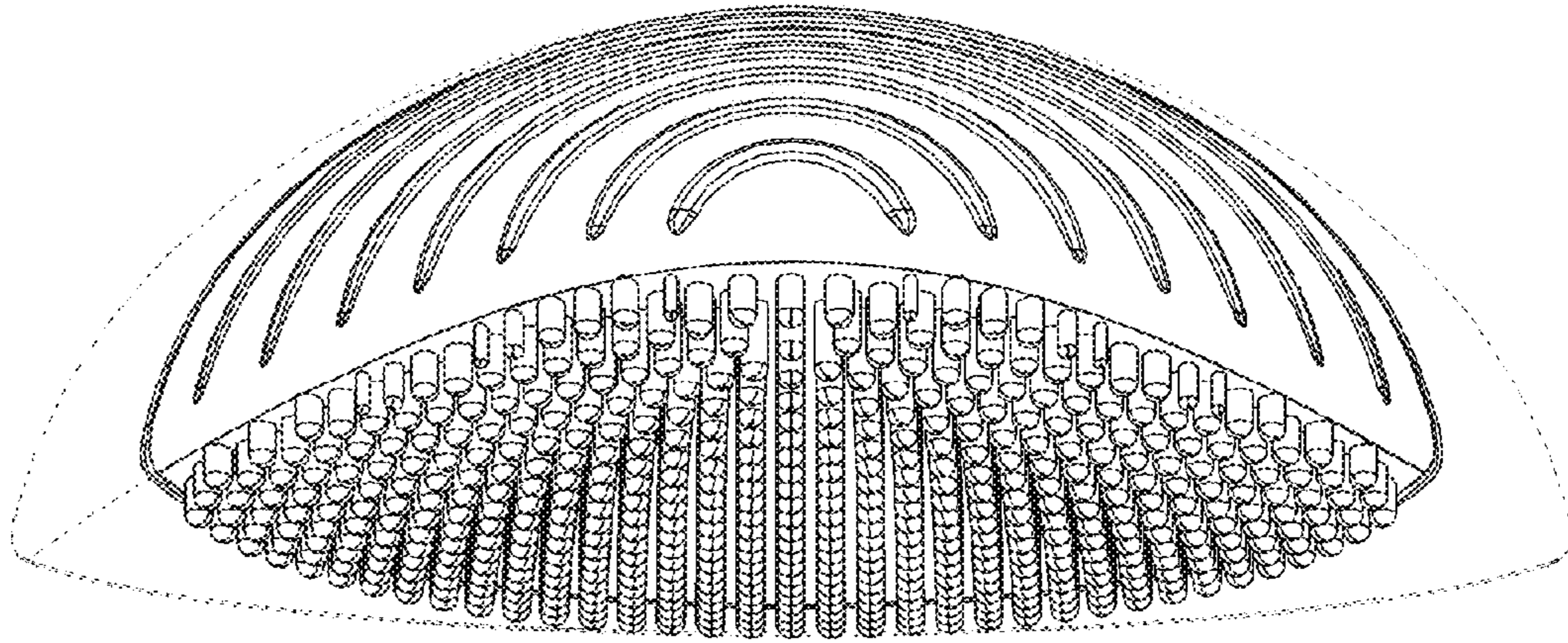

FIG. 13

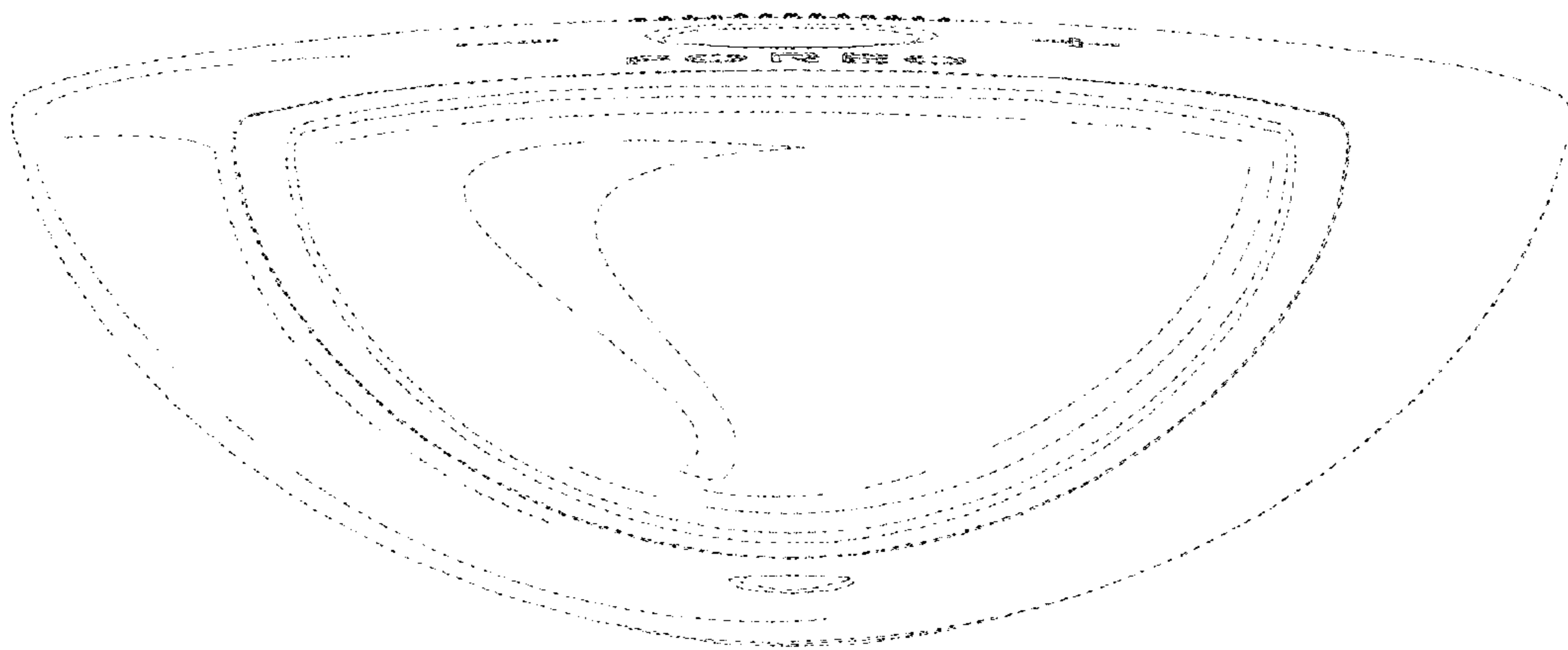

FIG. 14

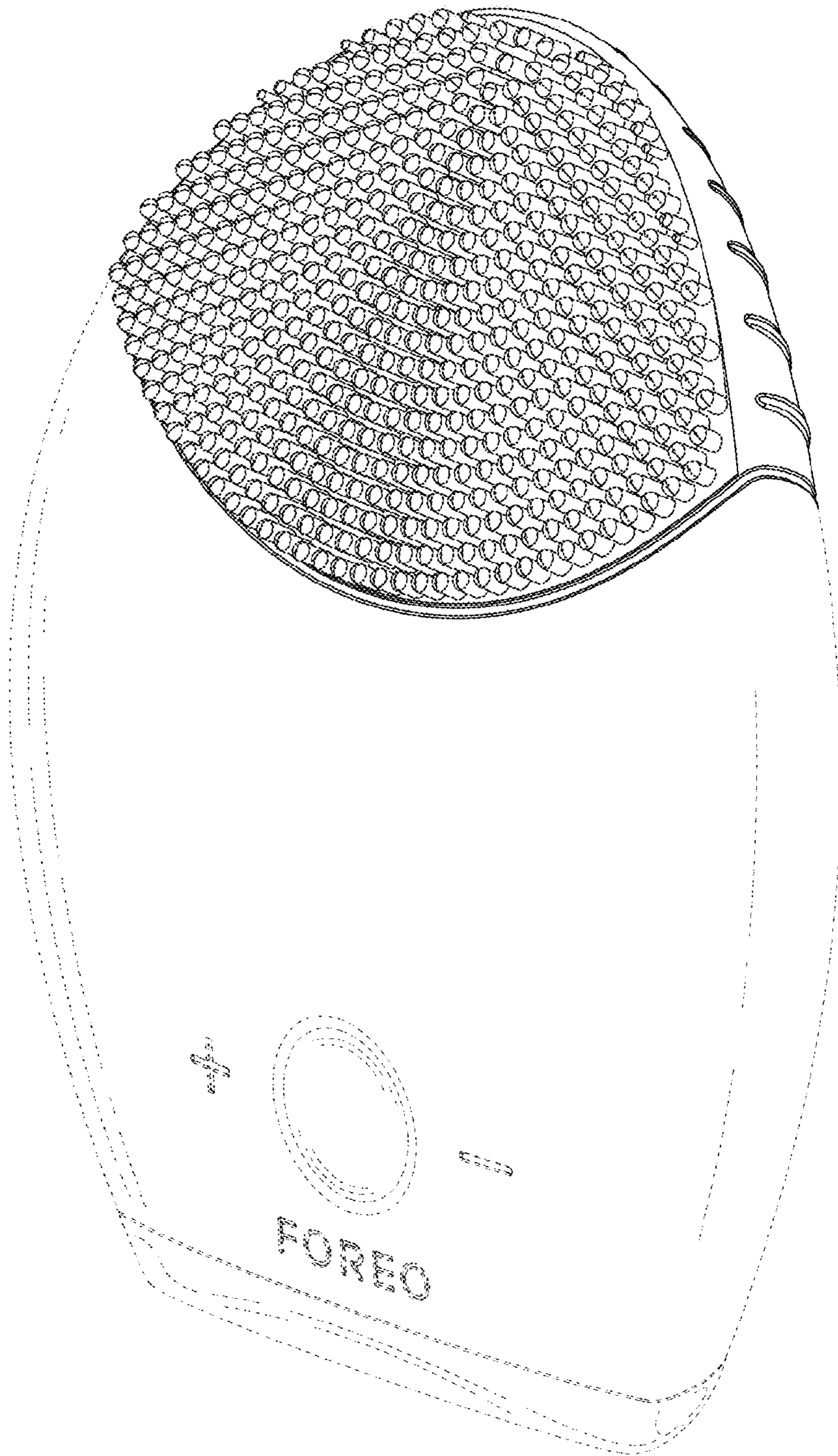

FIG. 15

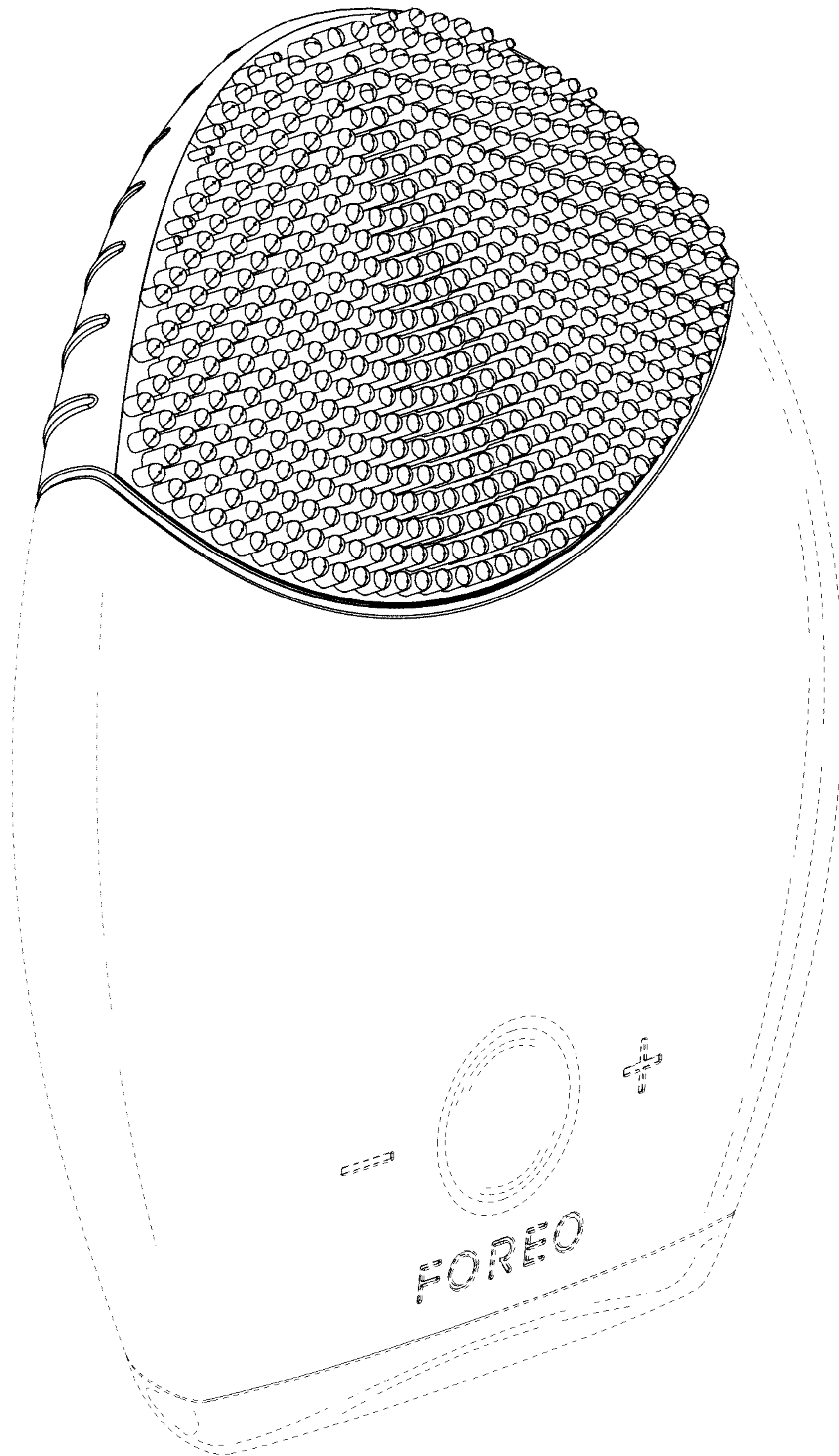

FIG. 16

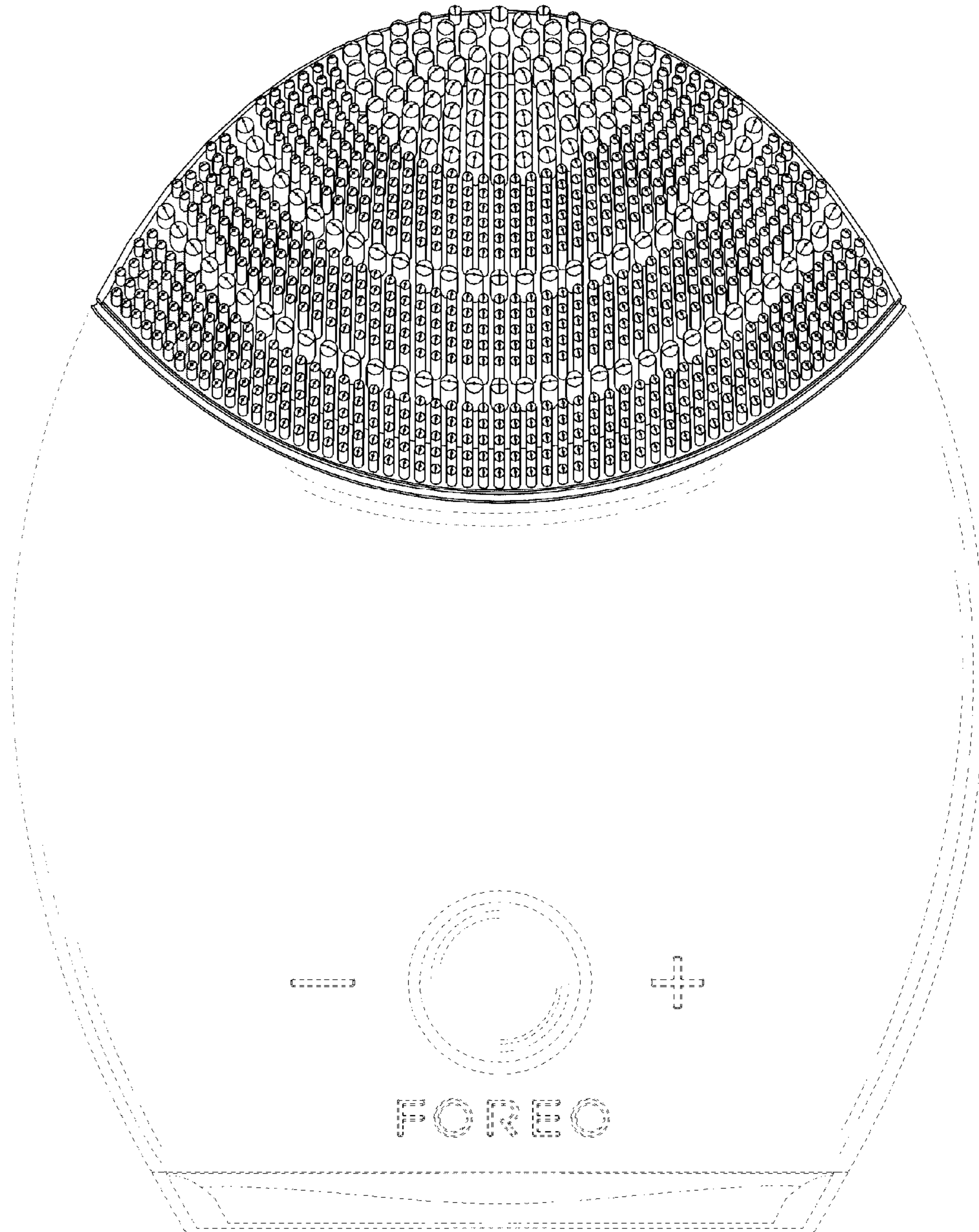

FIG. 17

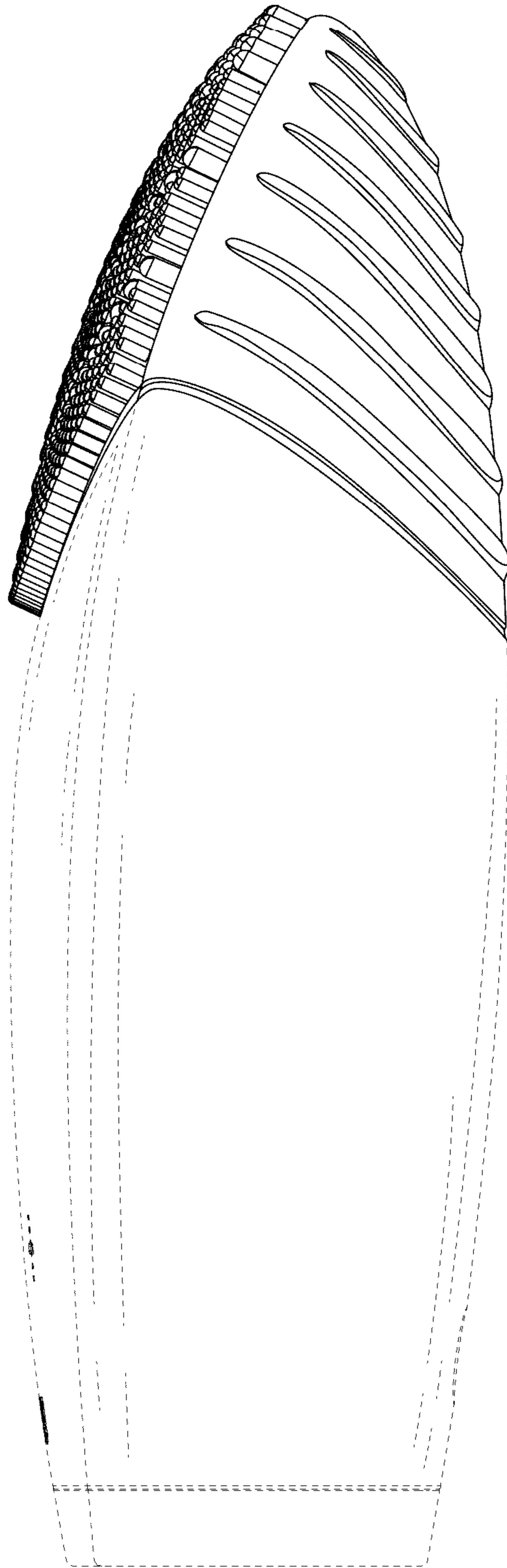

FIG. 18

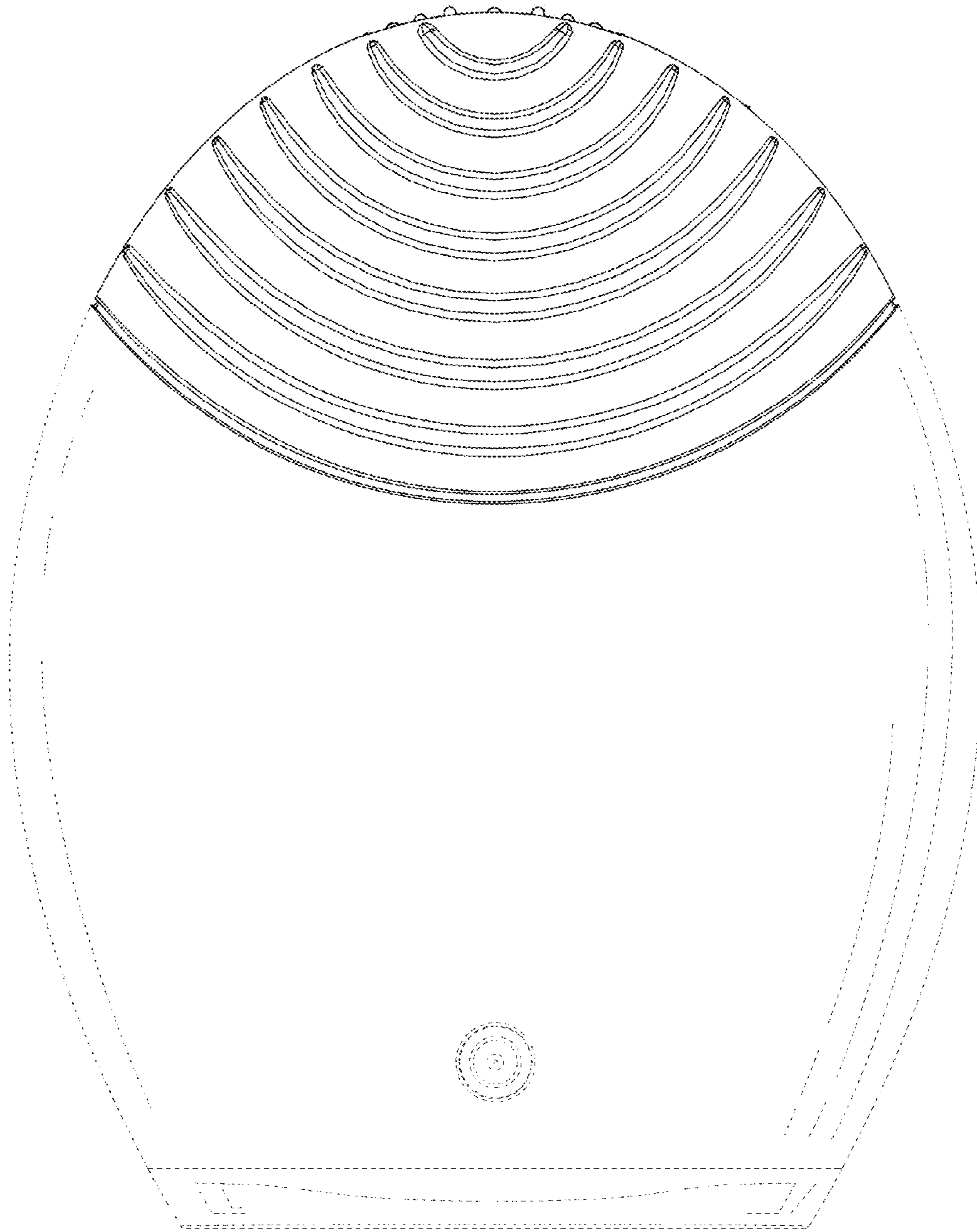

FIG. 19

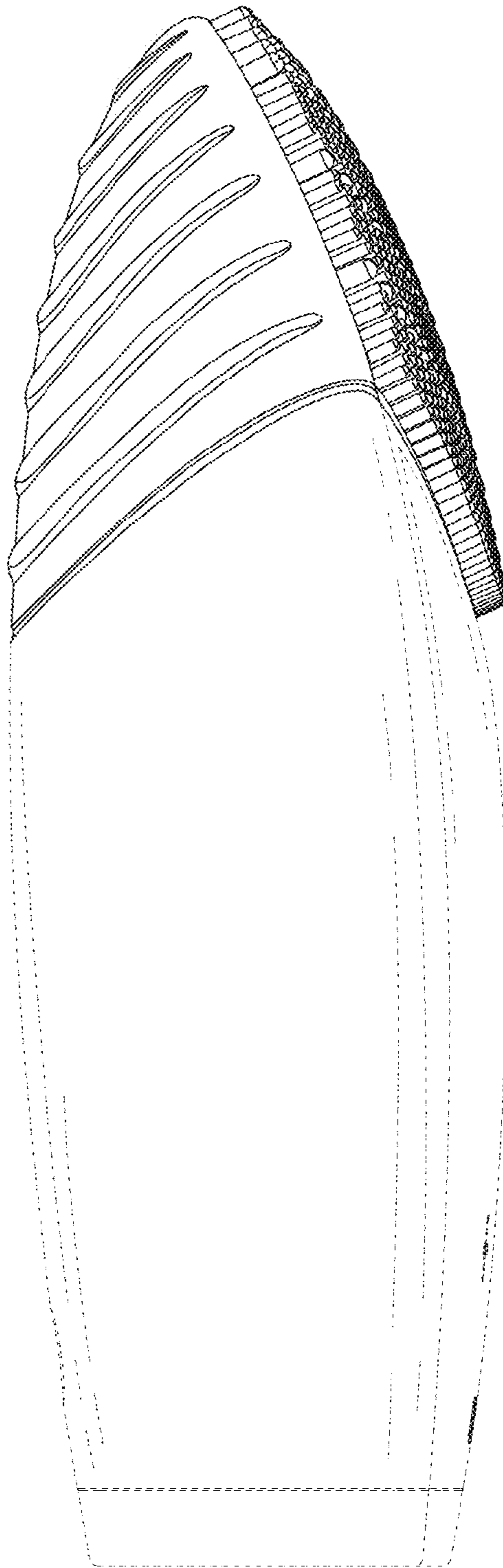

FIG. 20

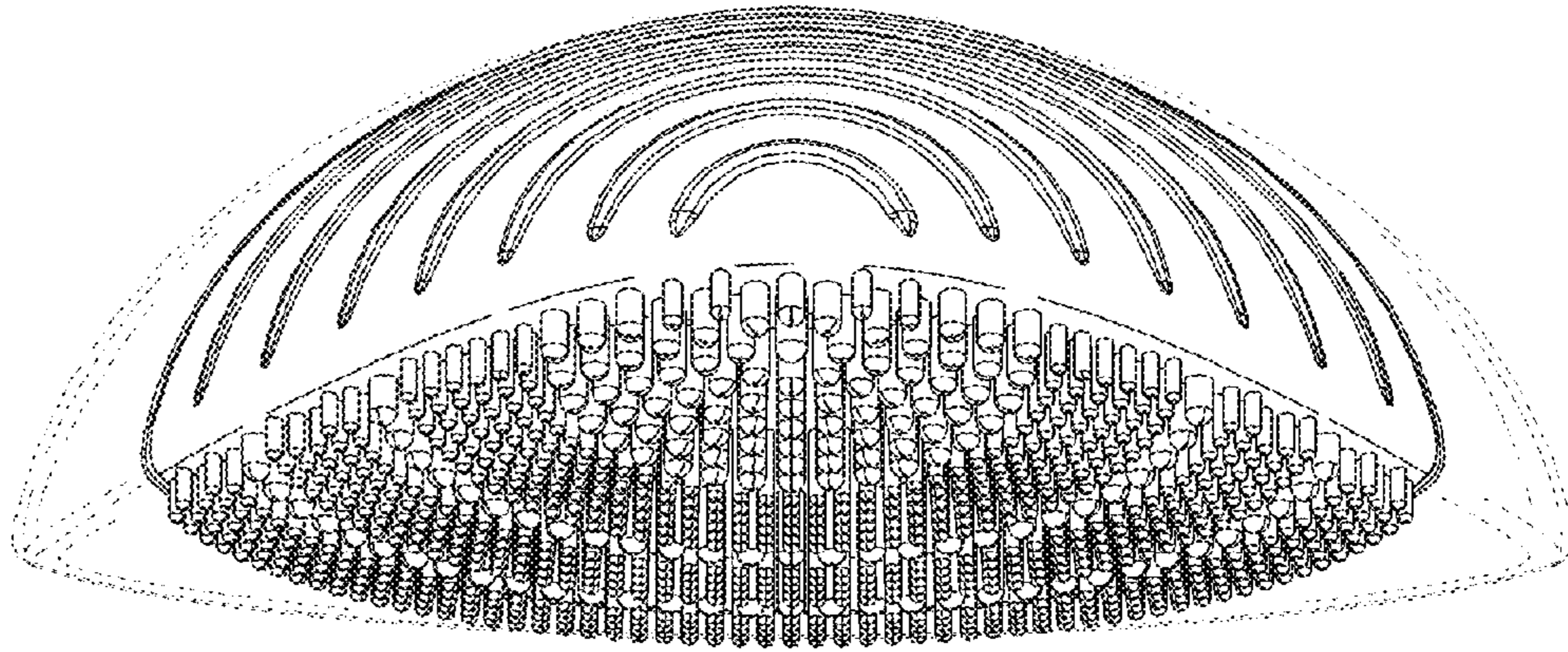

FIG. 21

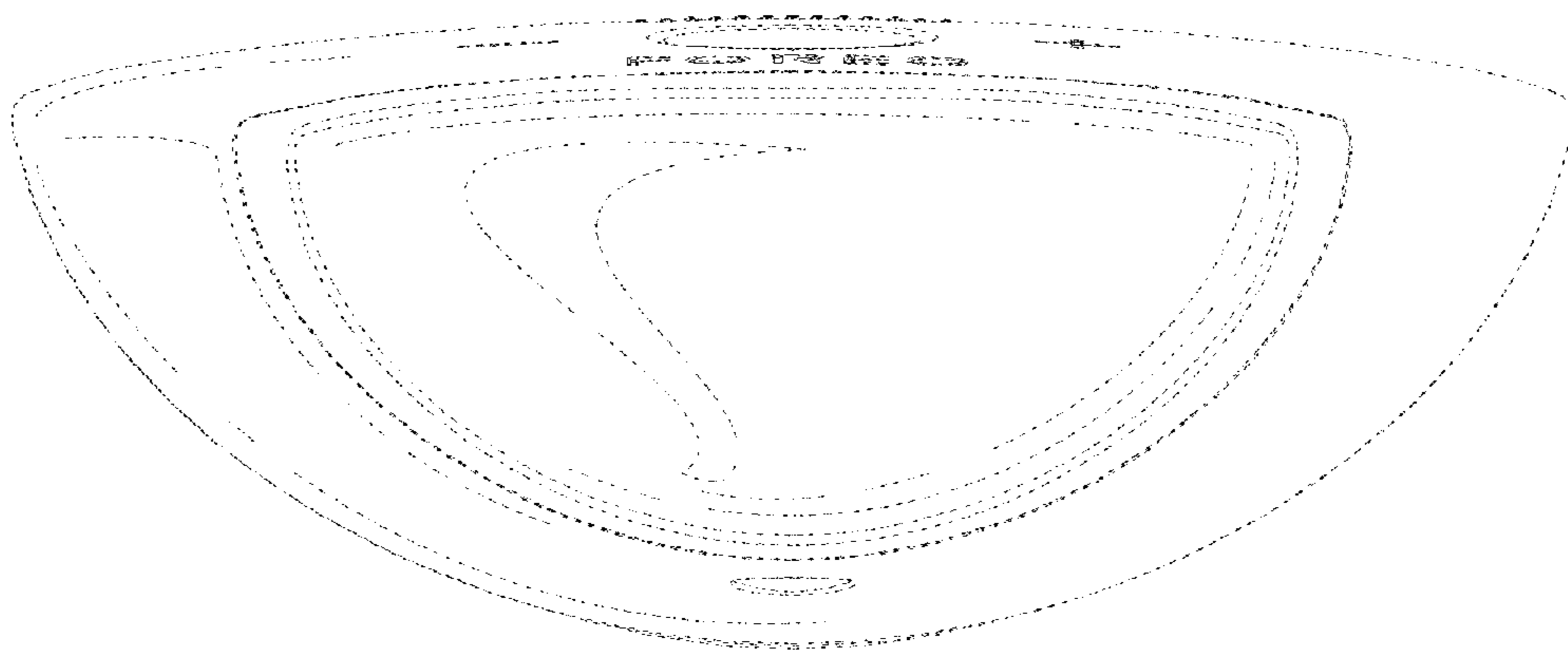

FIG. 22

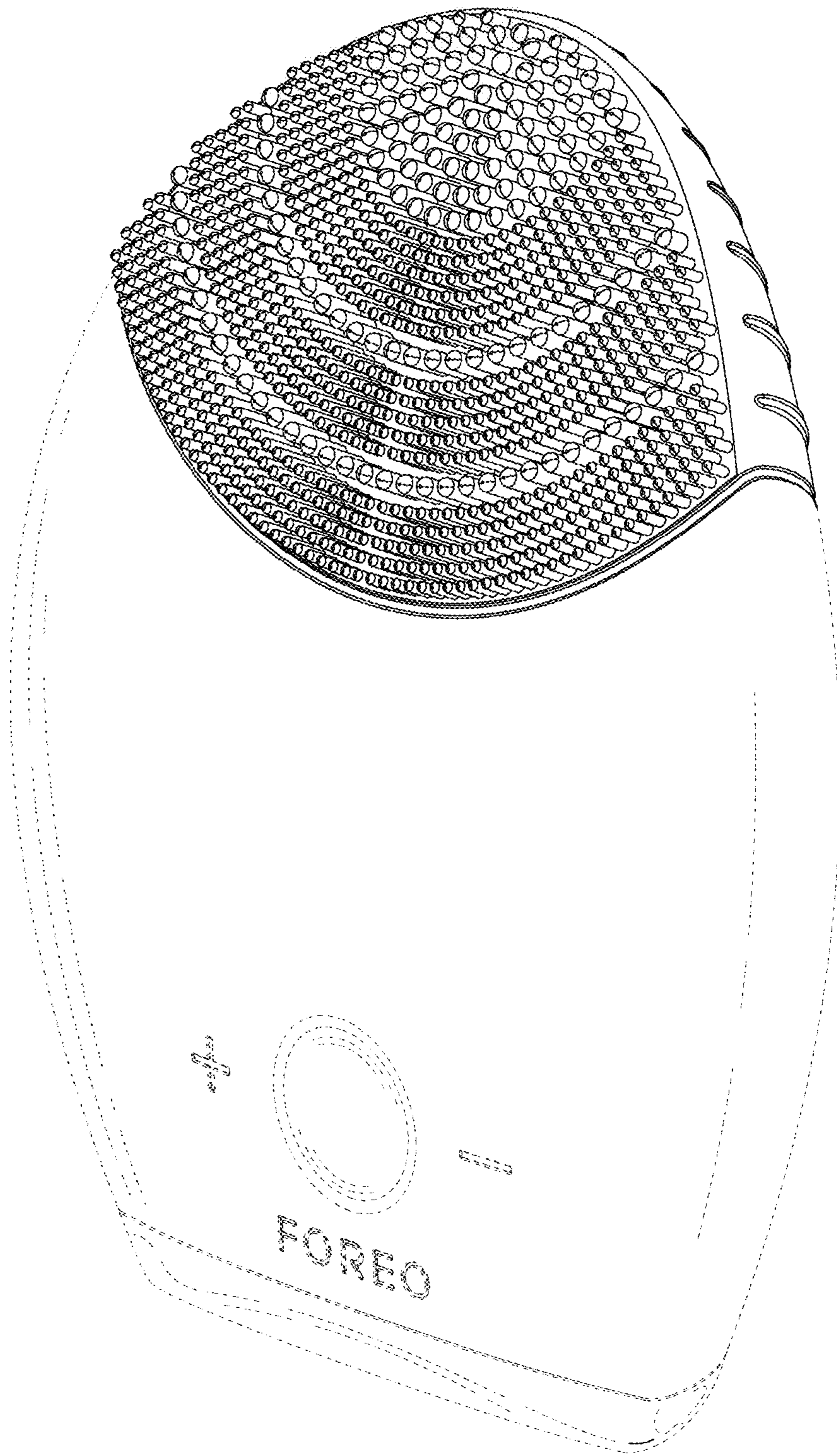

FIG. 23

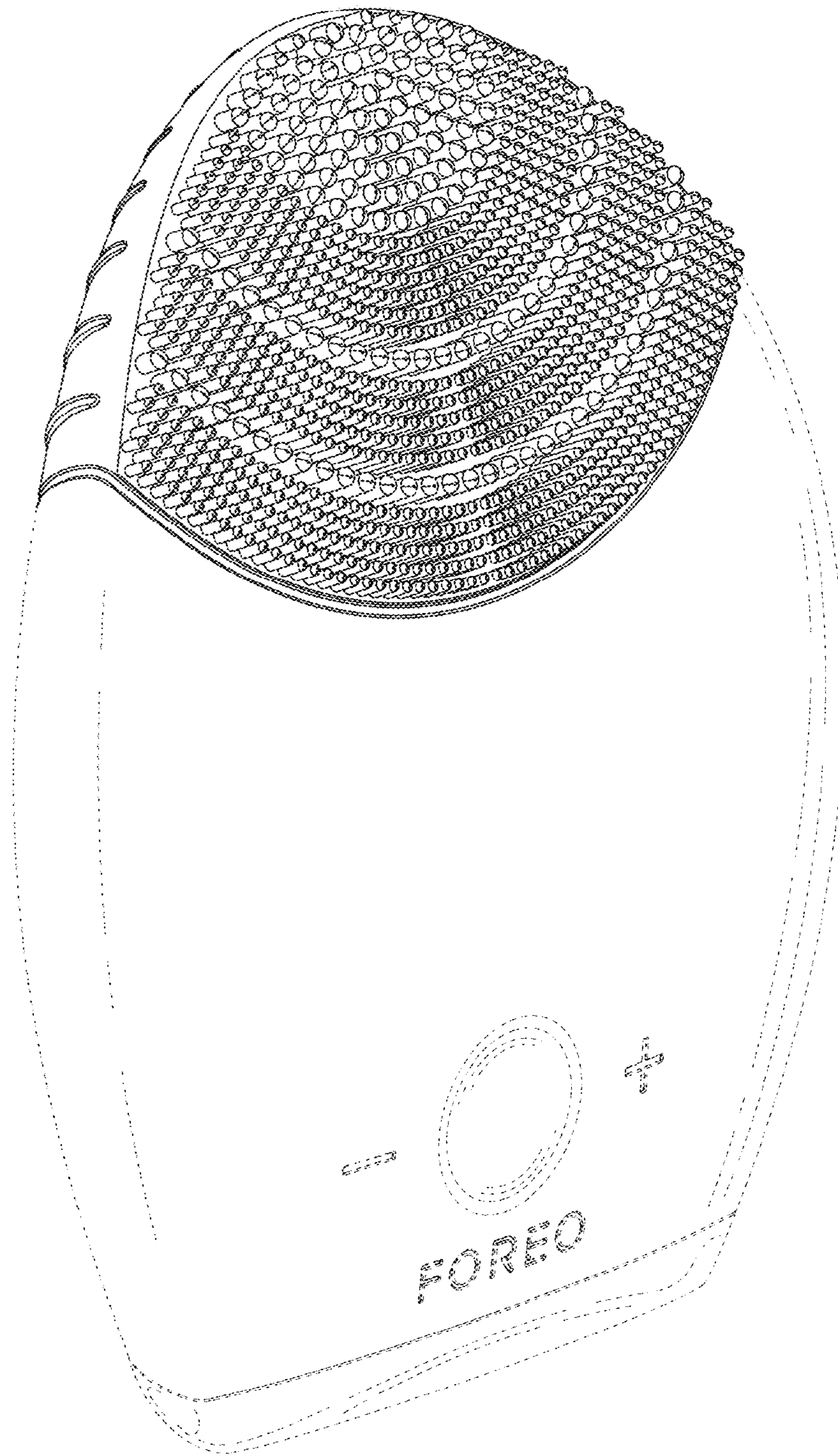

FIG. 24

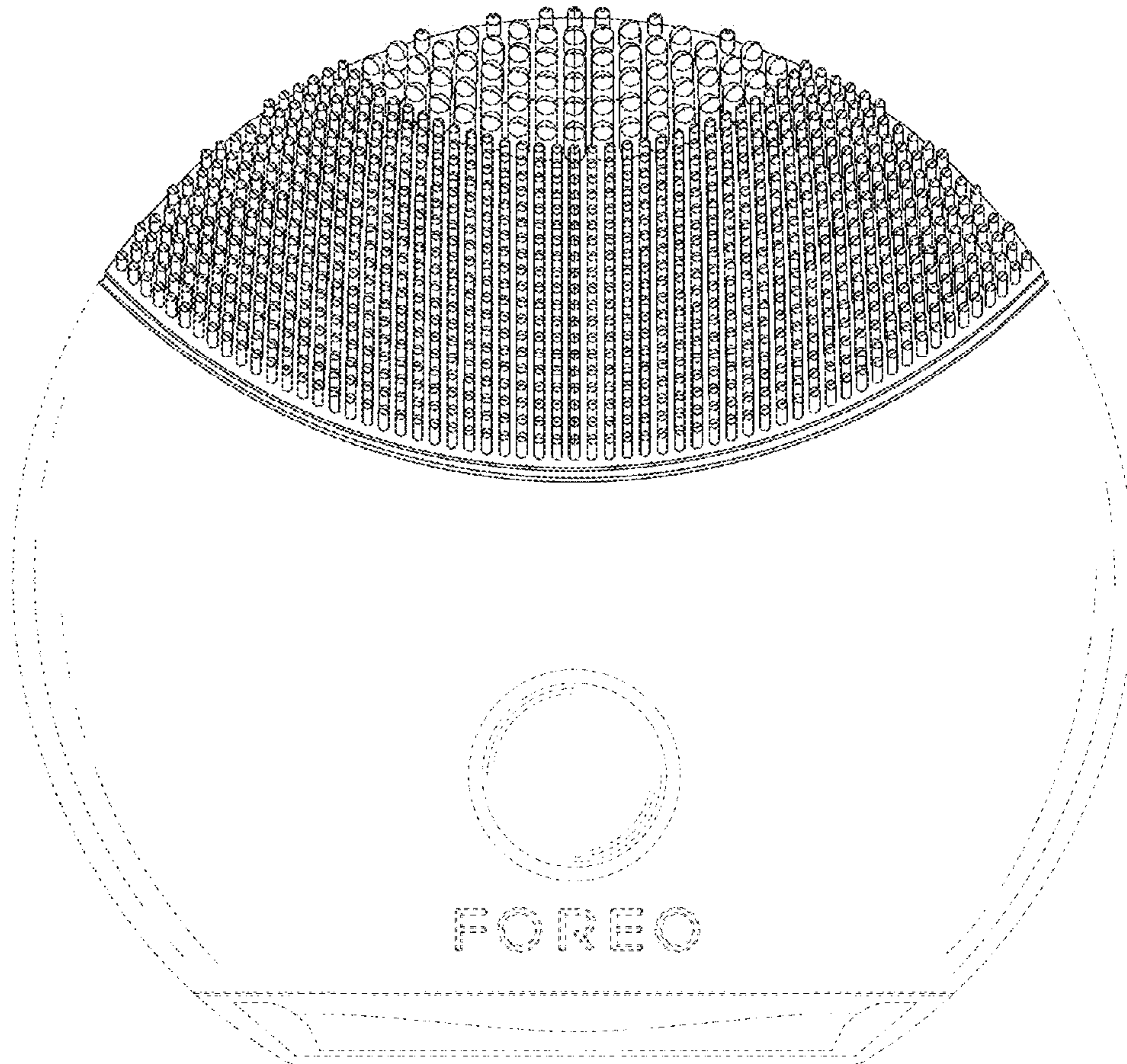

FIG. 25

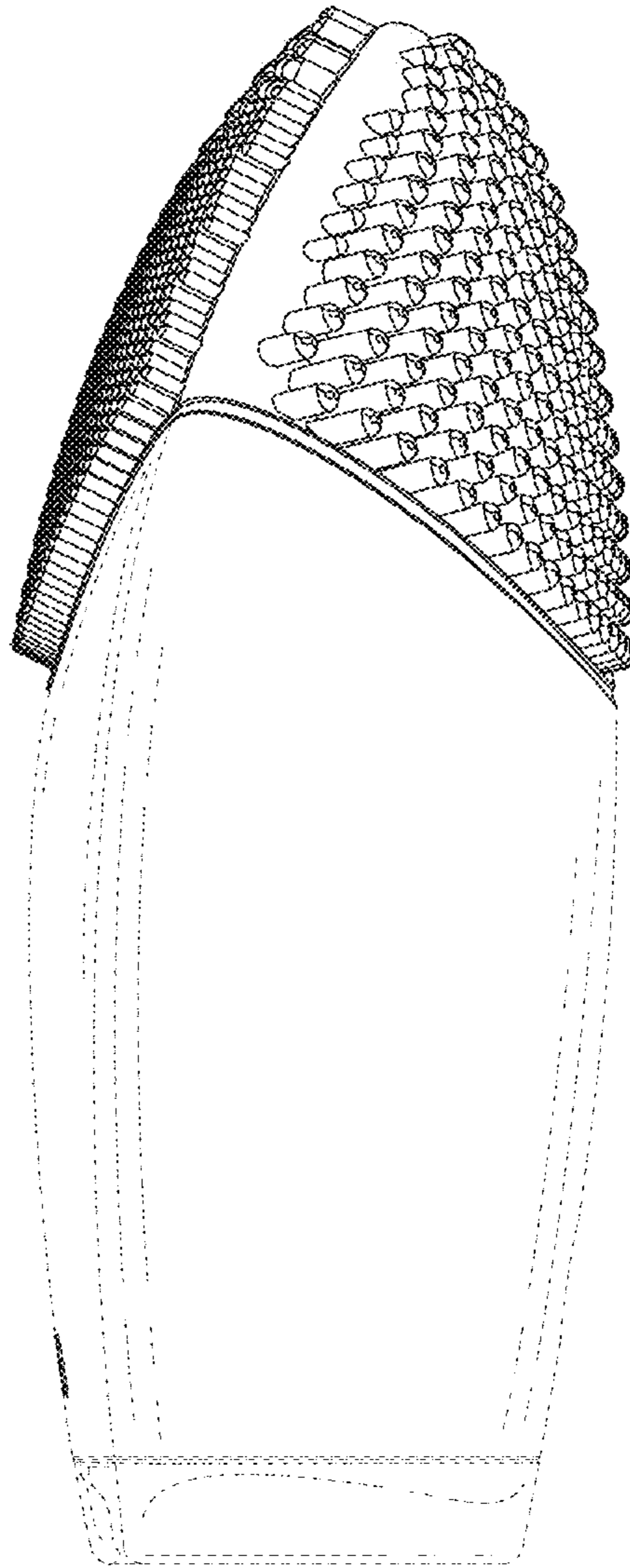

FIG. 26

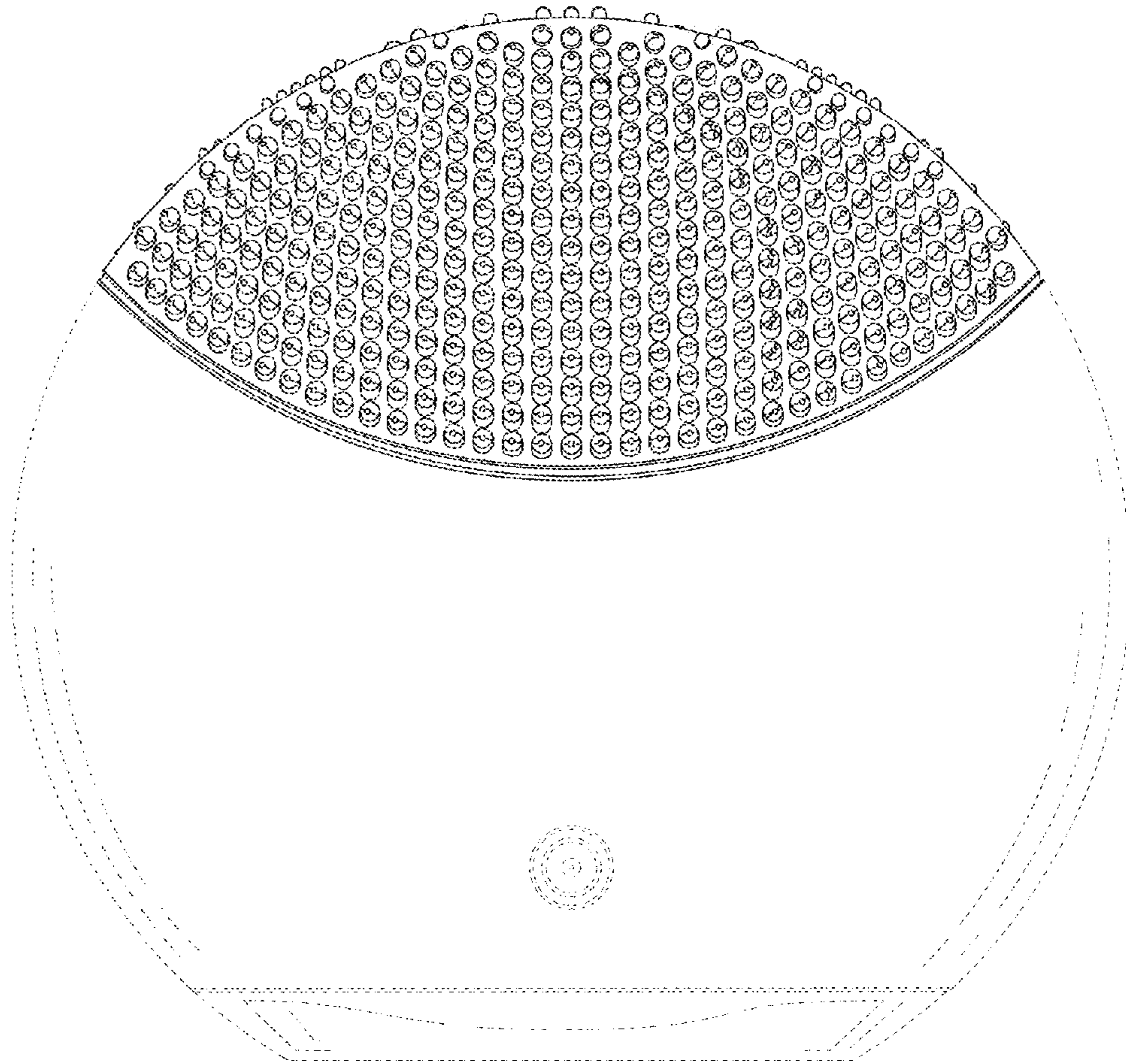

FIG. 27

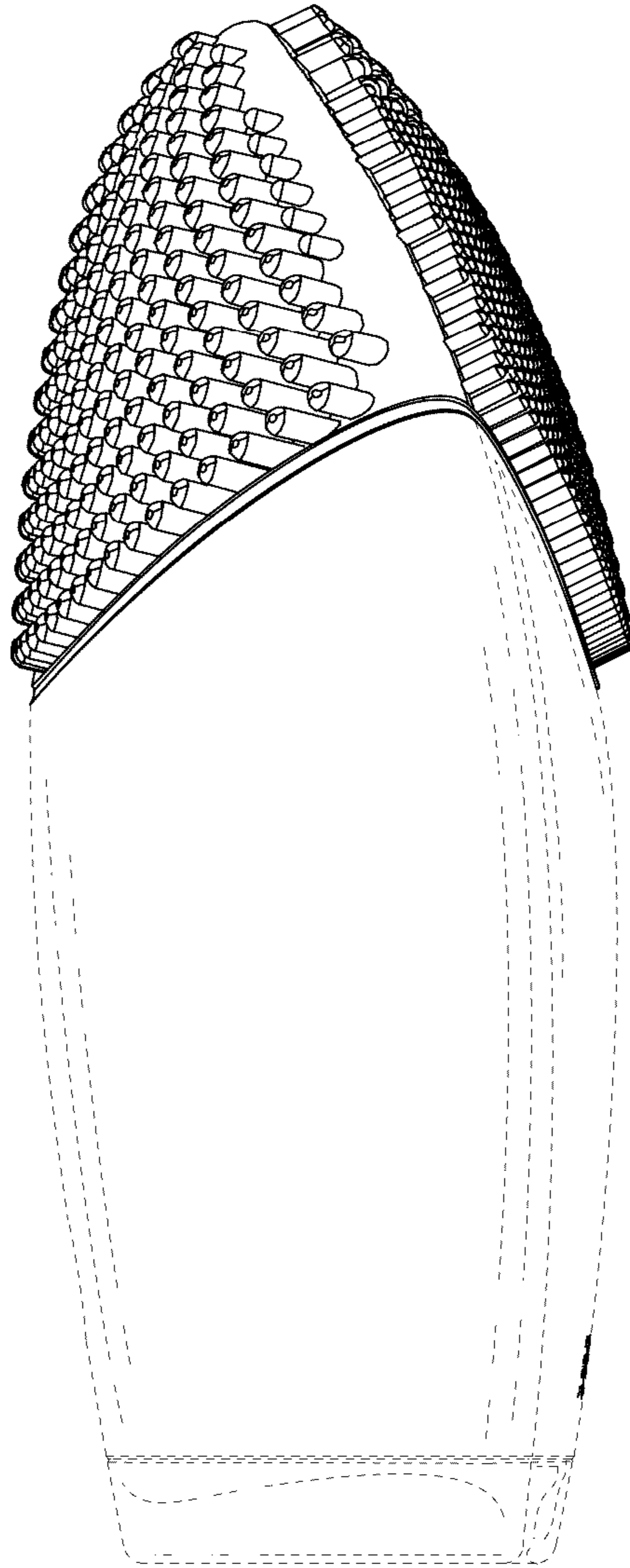

FIG. 28

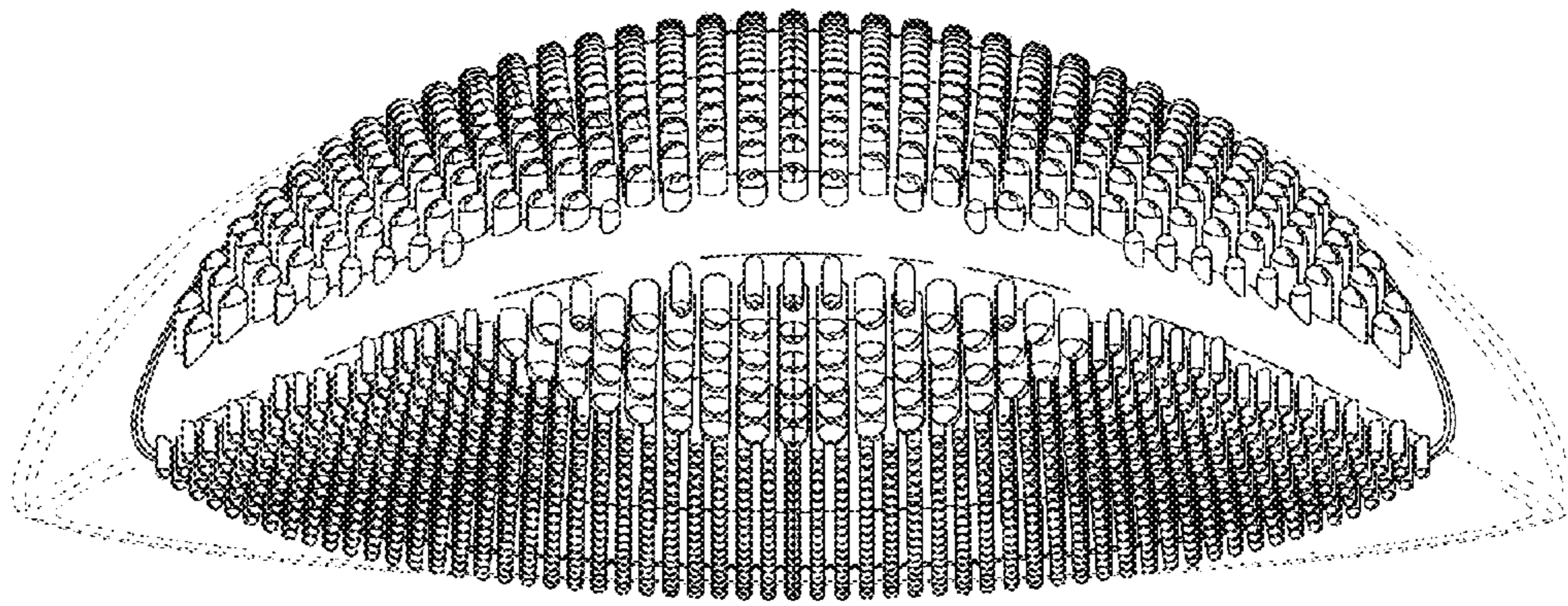

FIG. 29

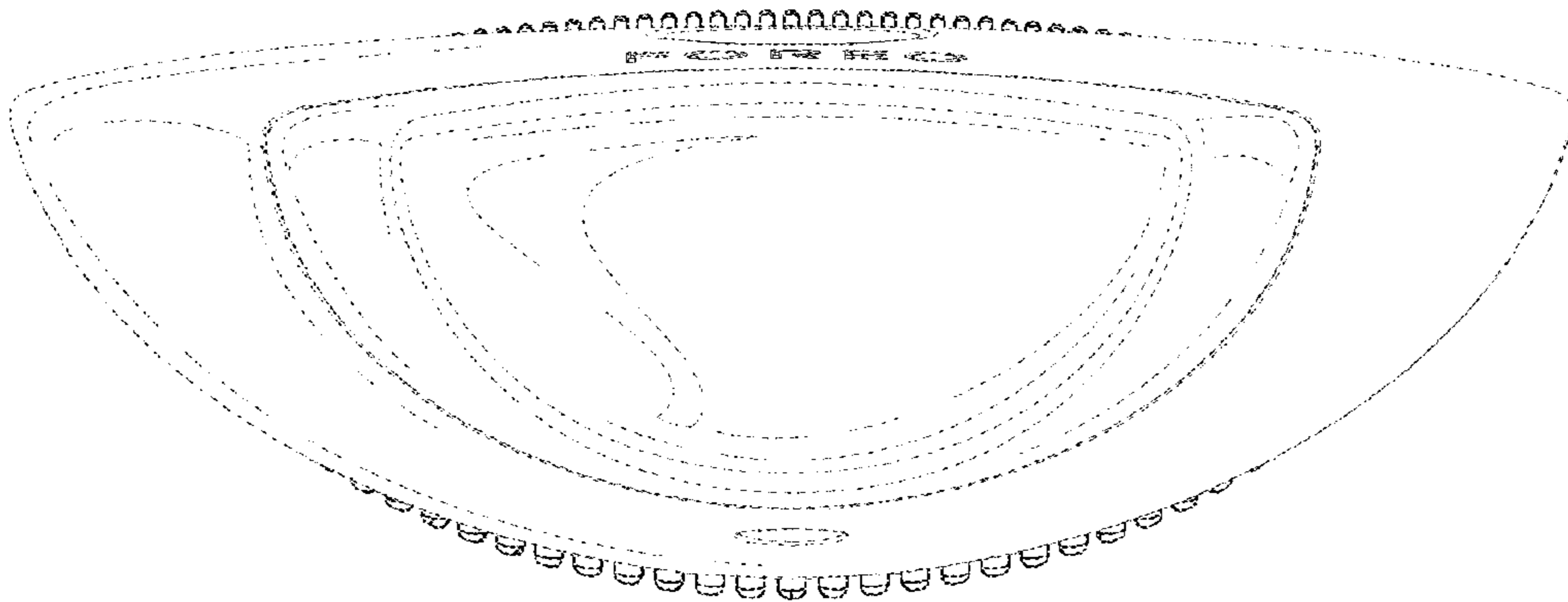

FIG. 30

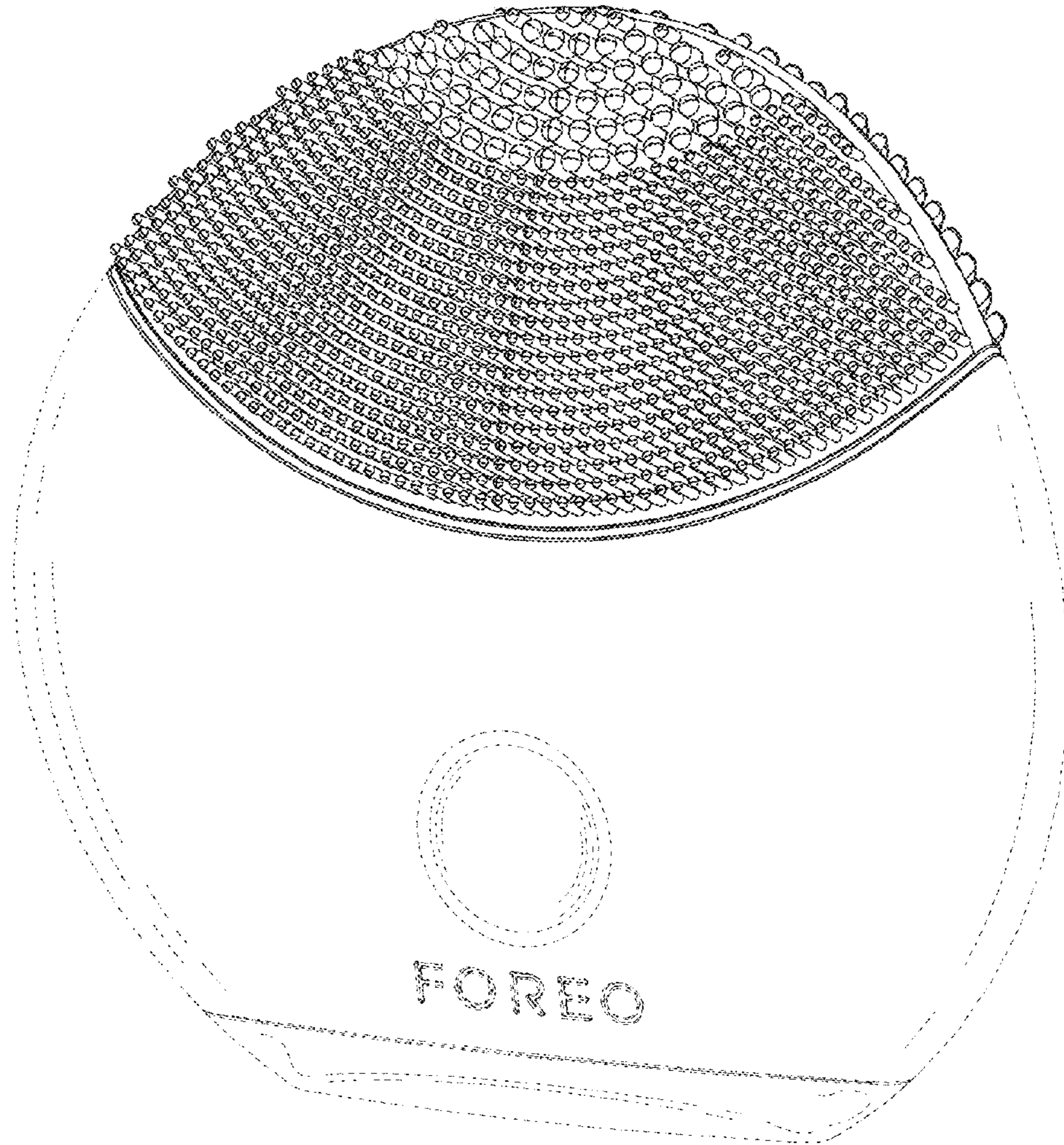

FIG. 31

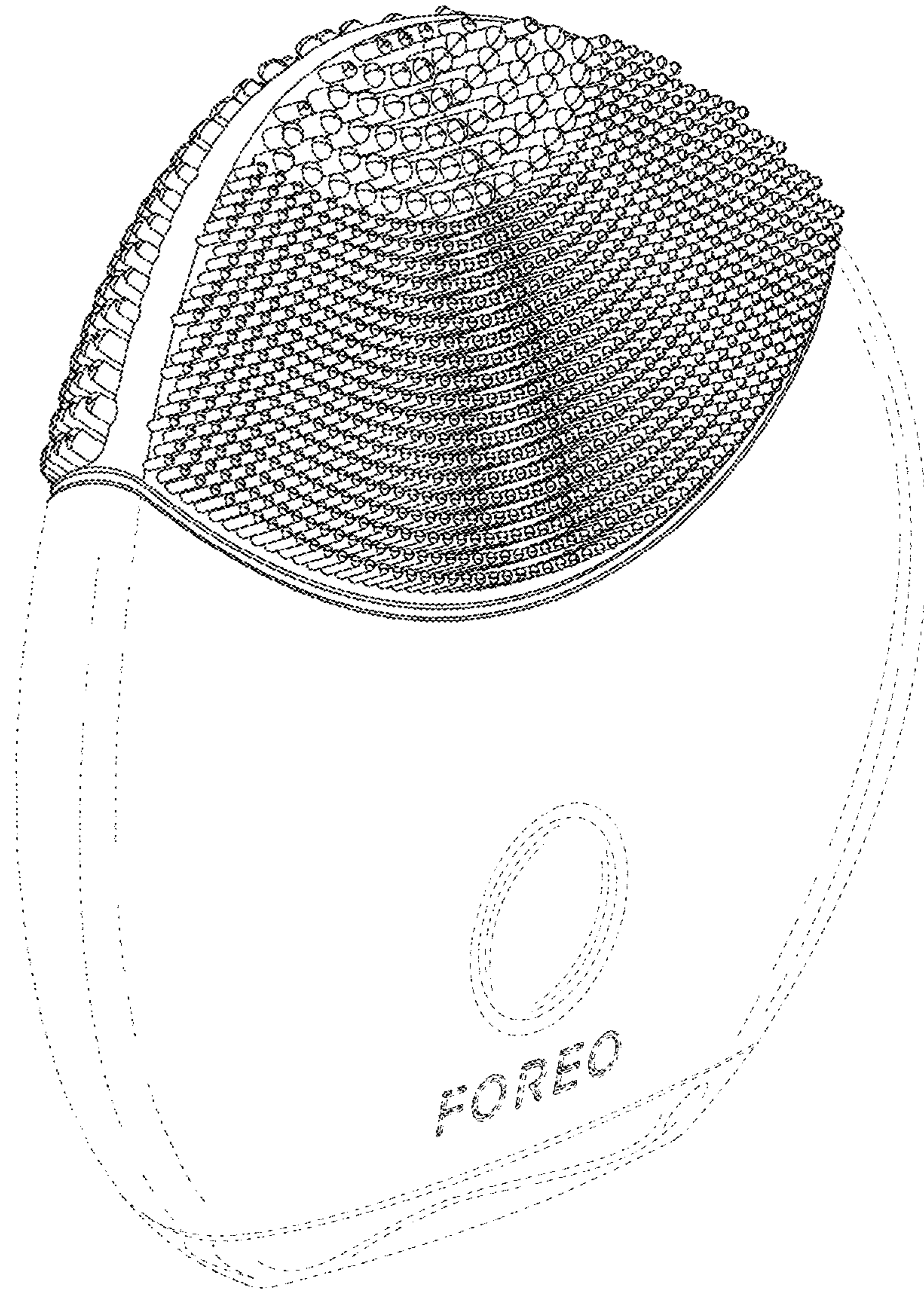

FIG. 32

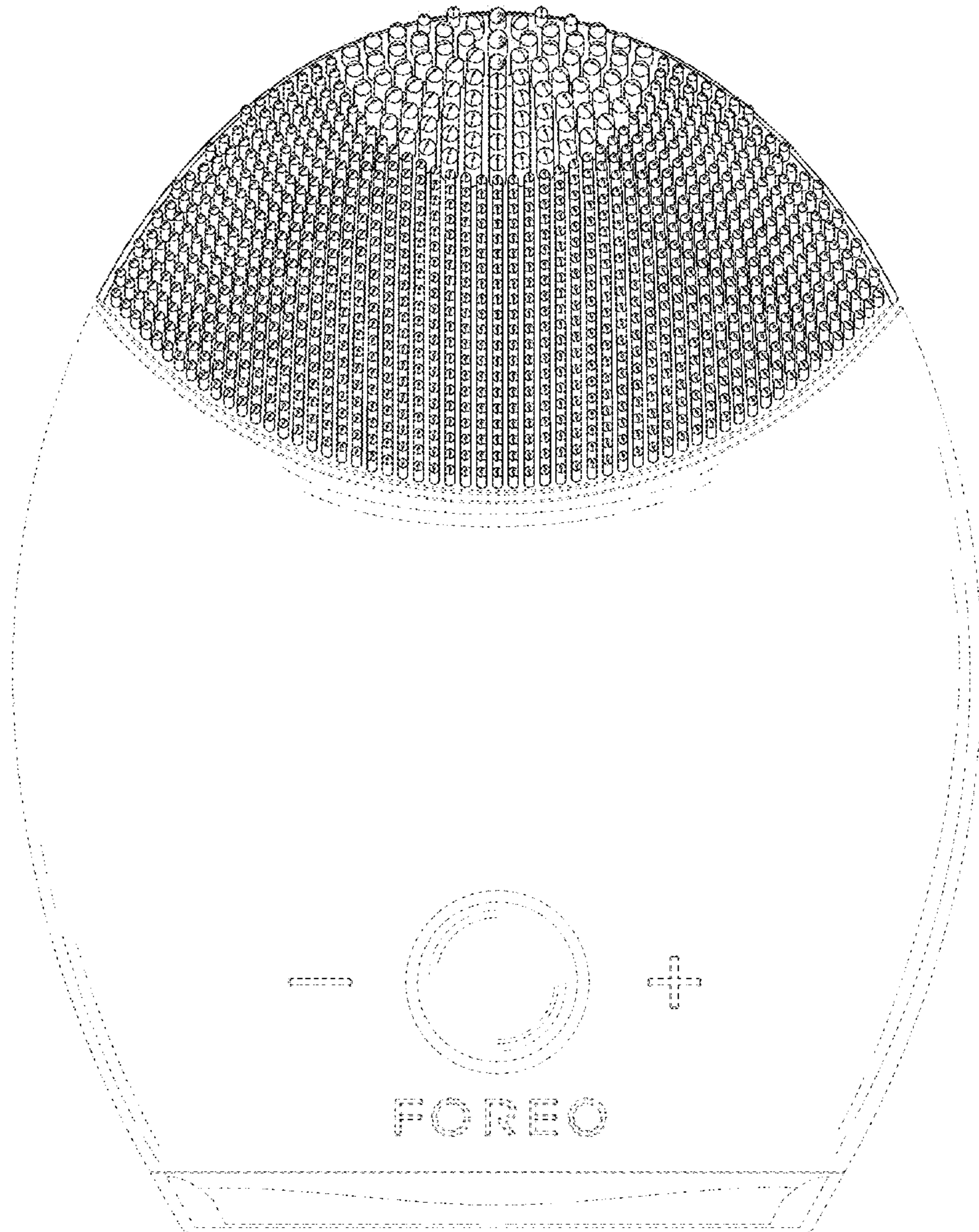

FIG. 33

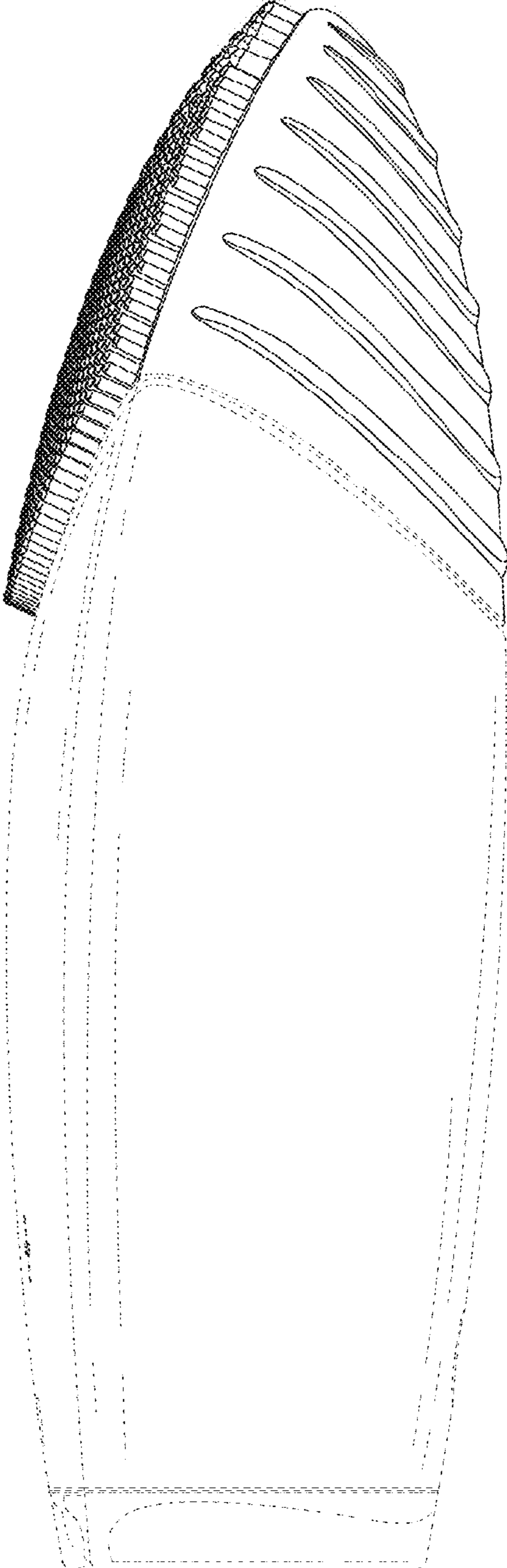

FIG. 34

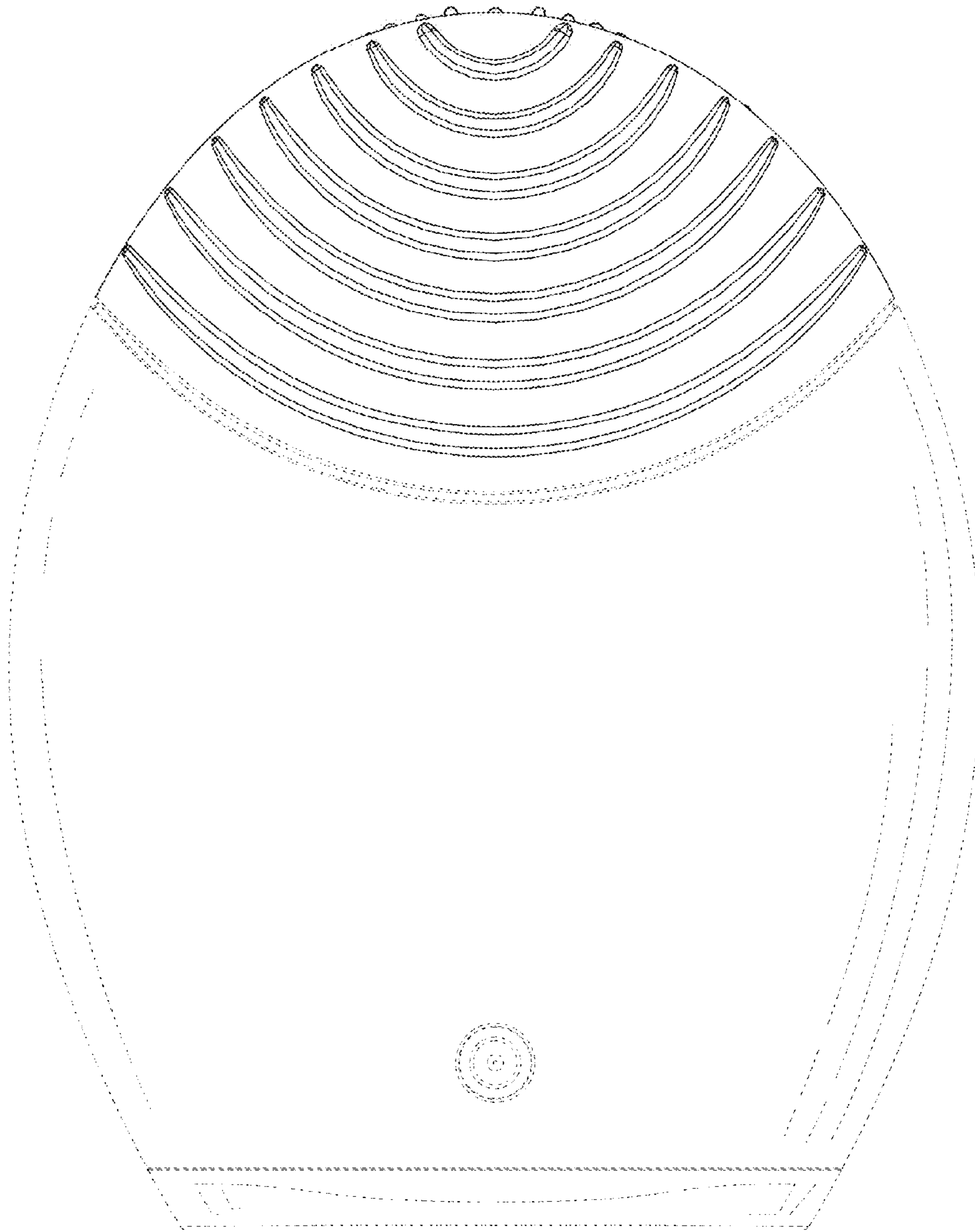

FIG. 35

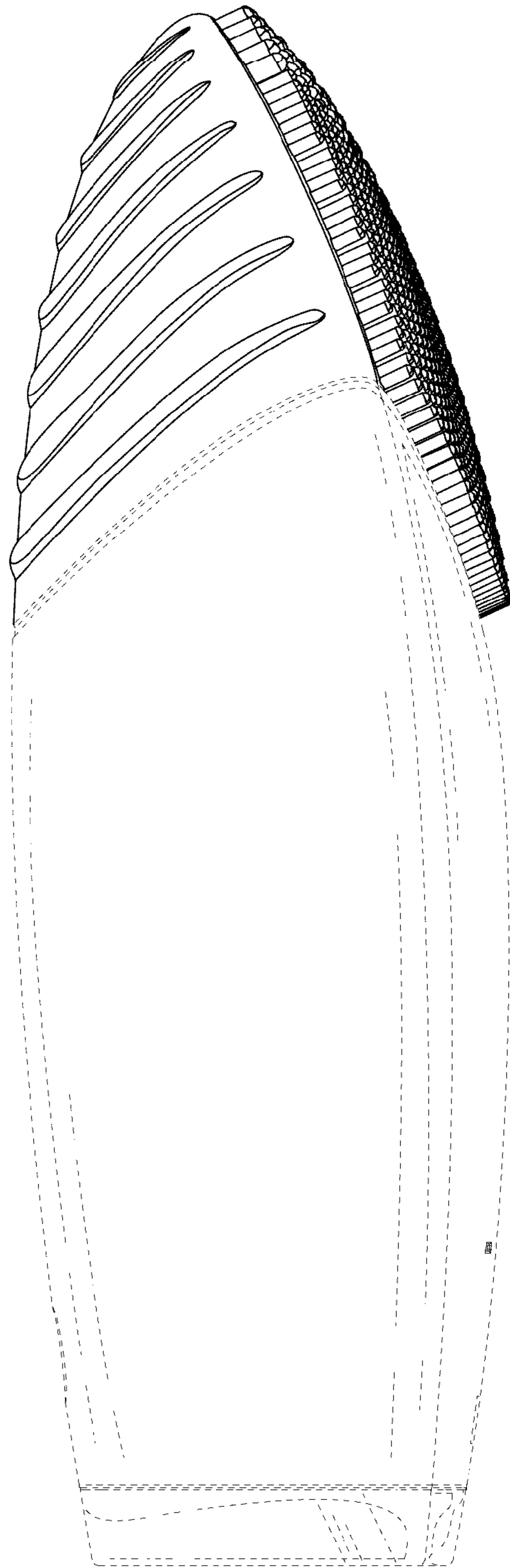

FIG. 36

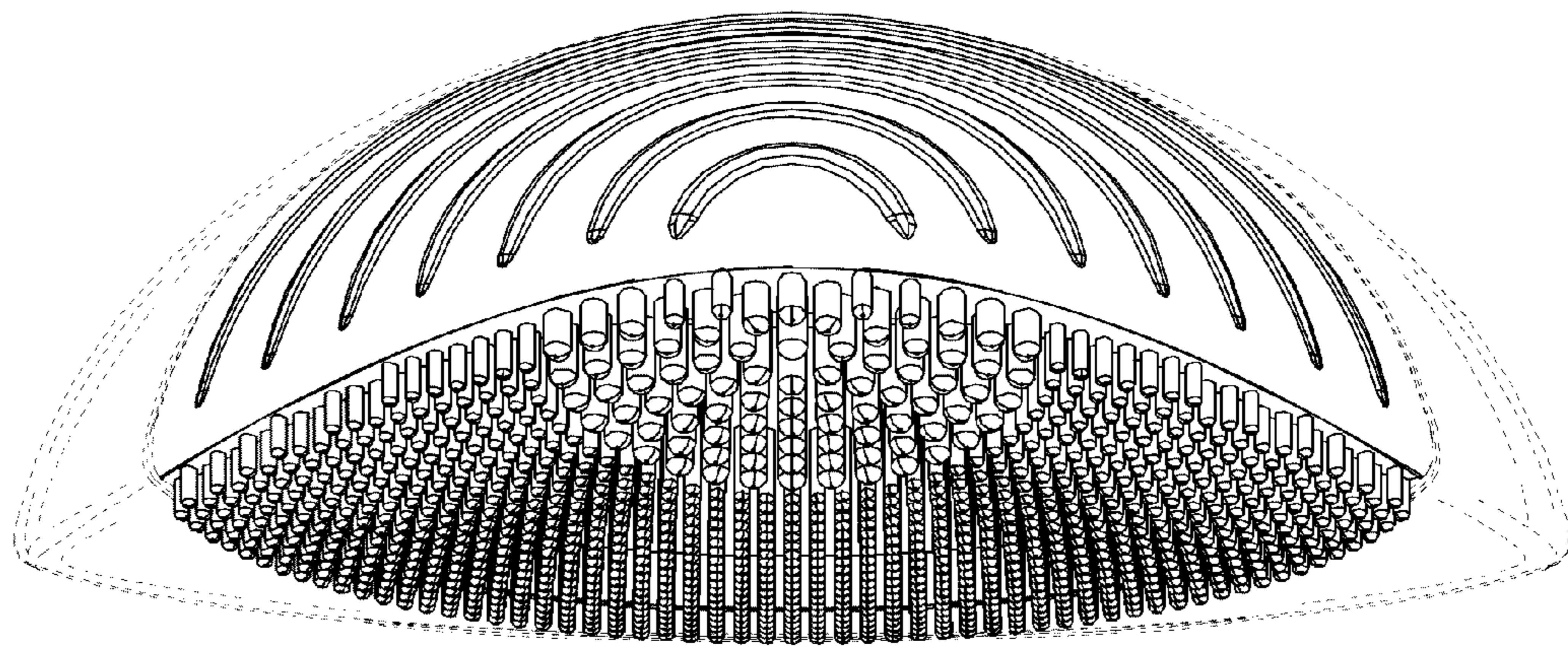

FIG. 37

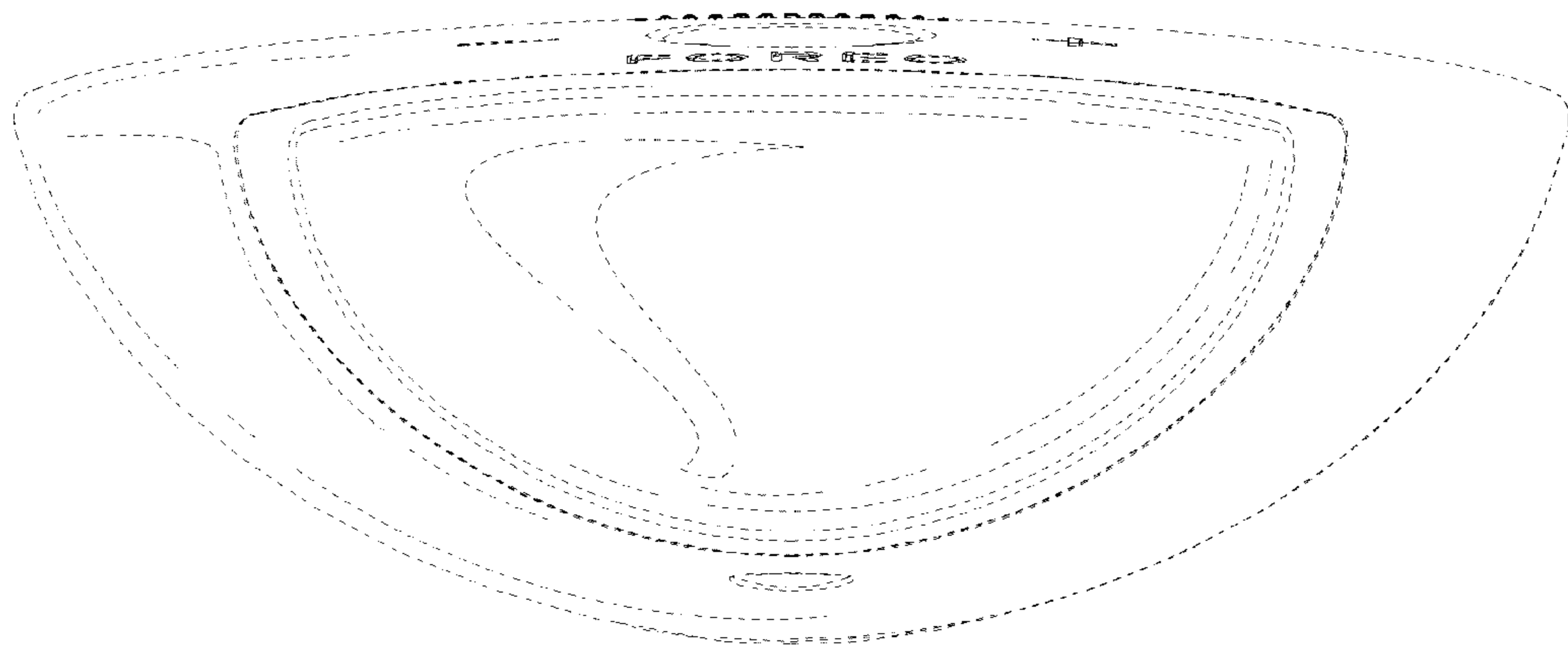

FIG. 38

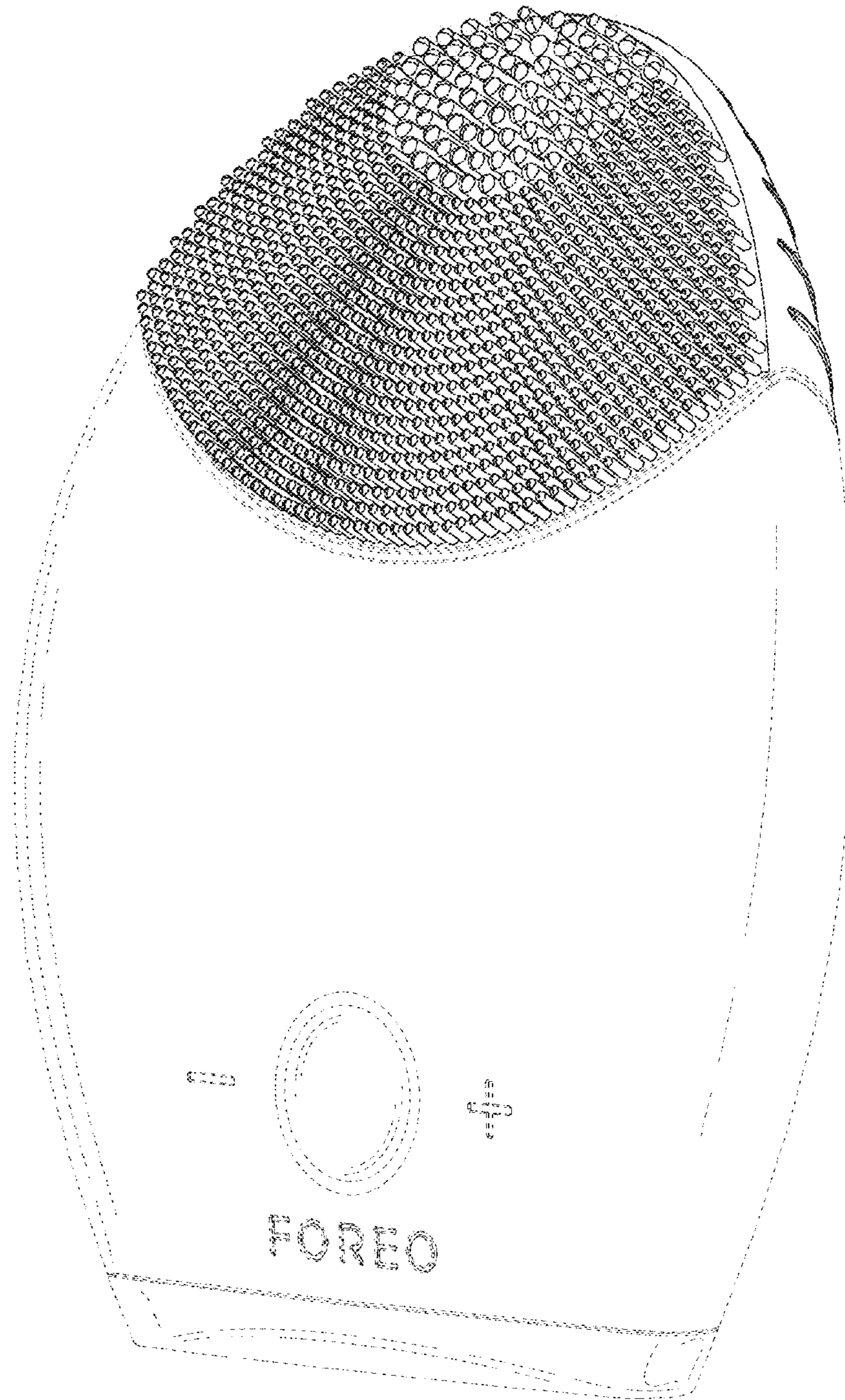

FIG. 39

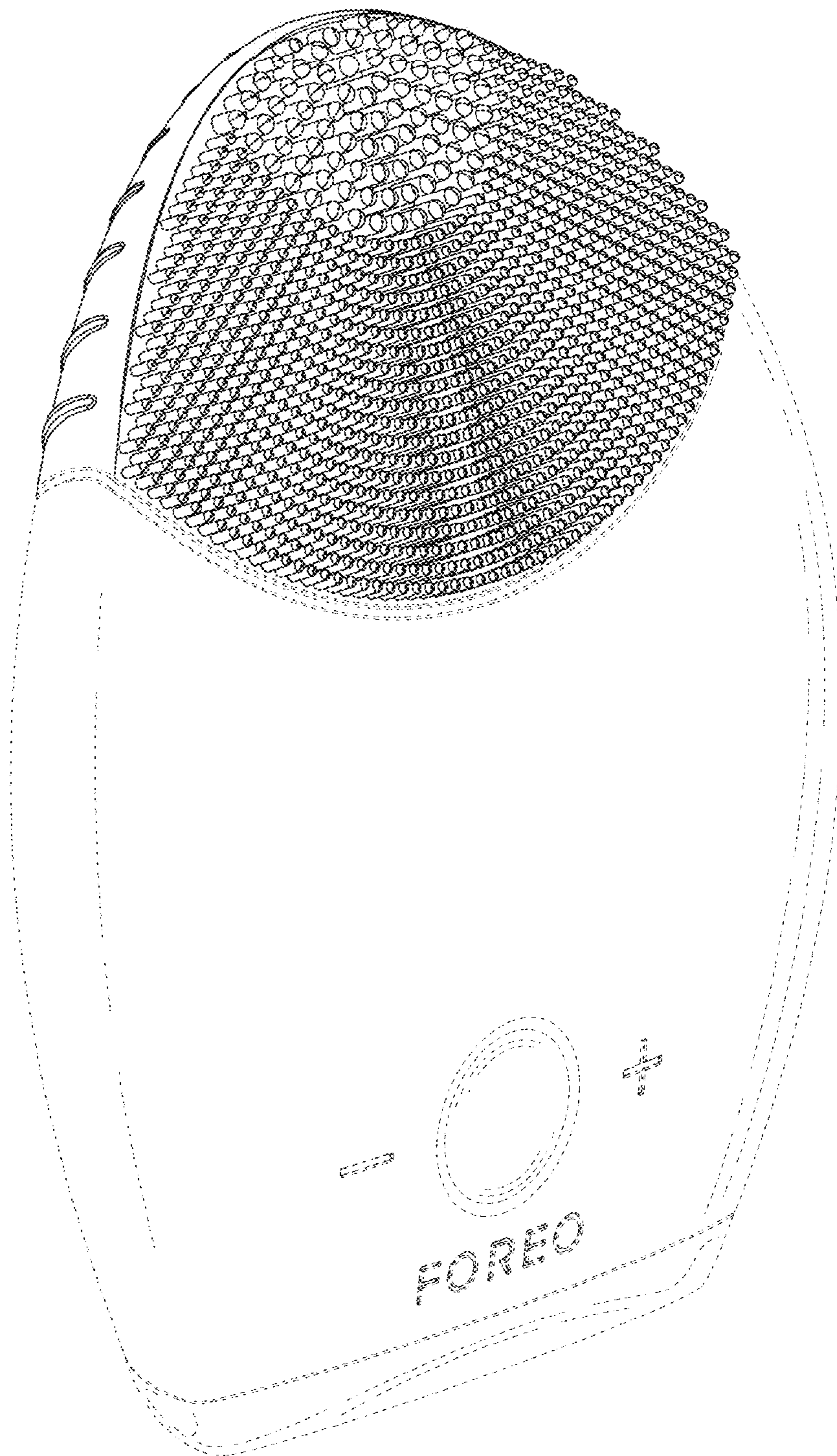

FIG. 40

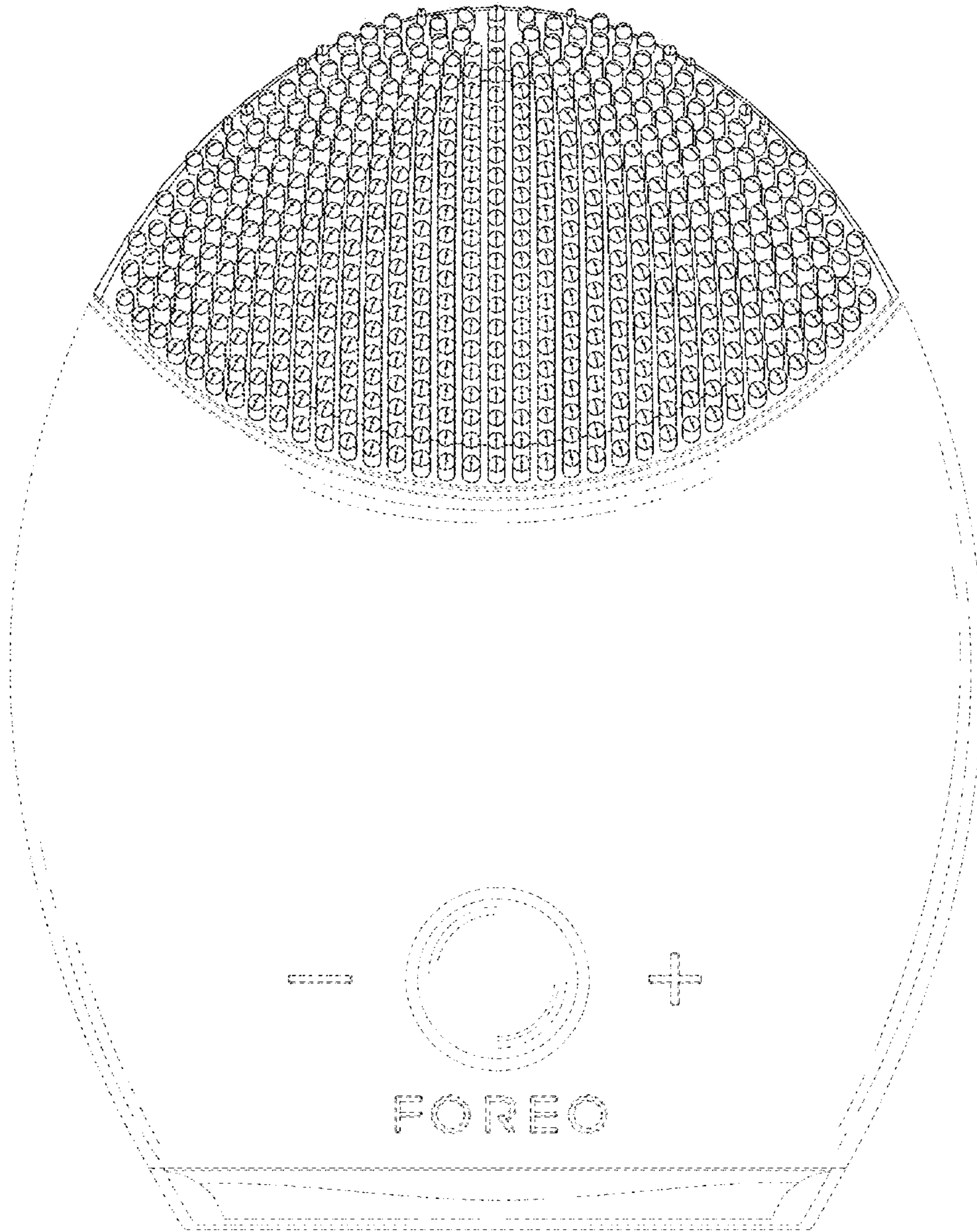

FIG. 41

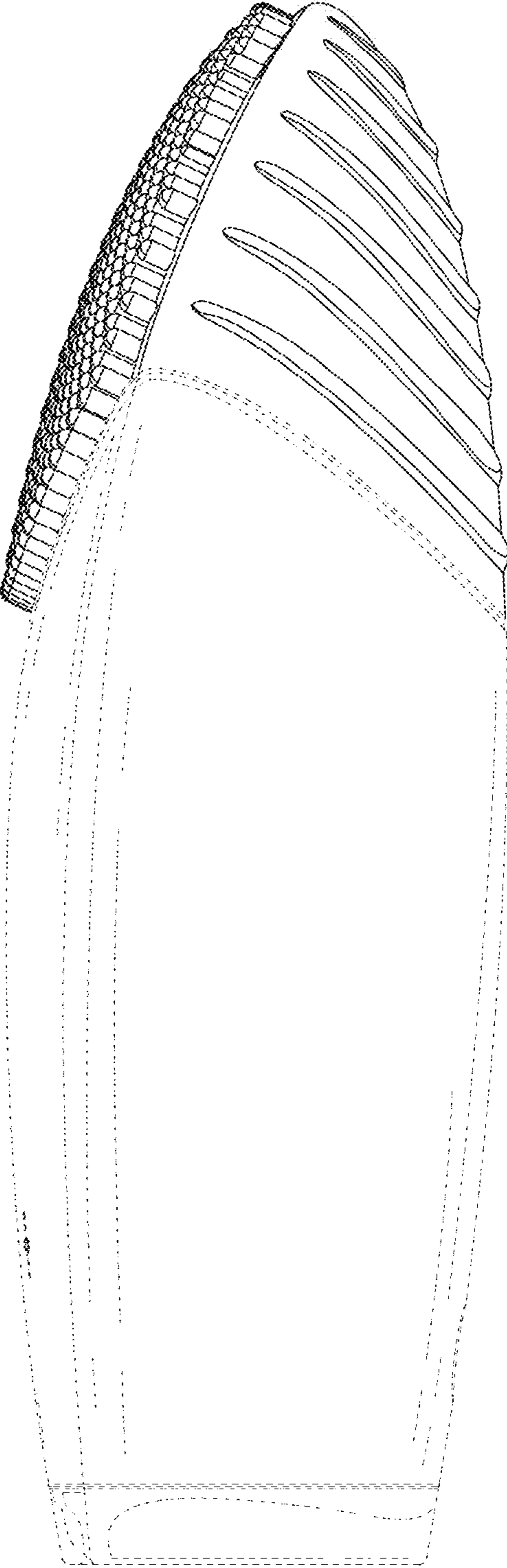

FIG. 42

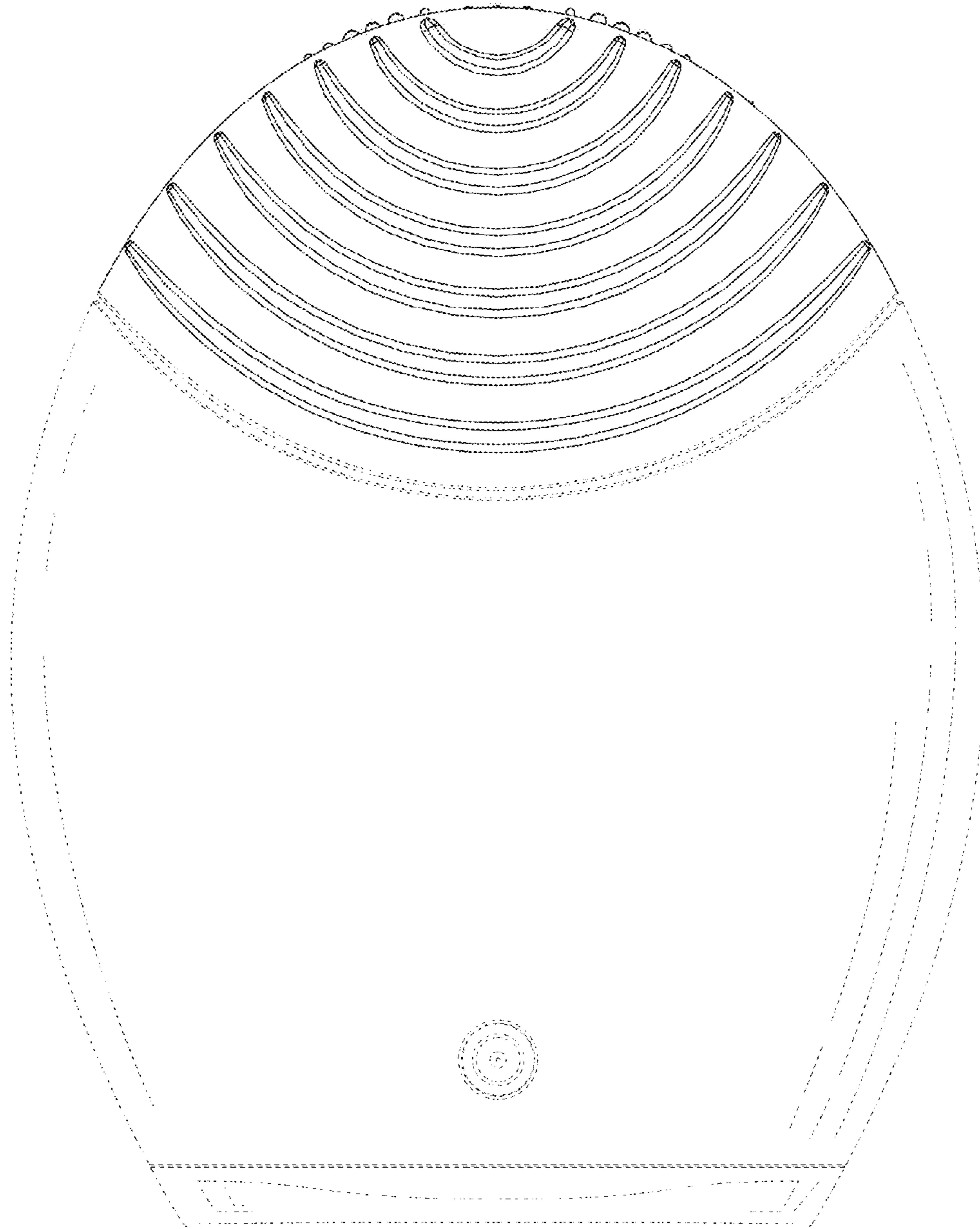

FIG. 43

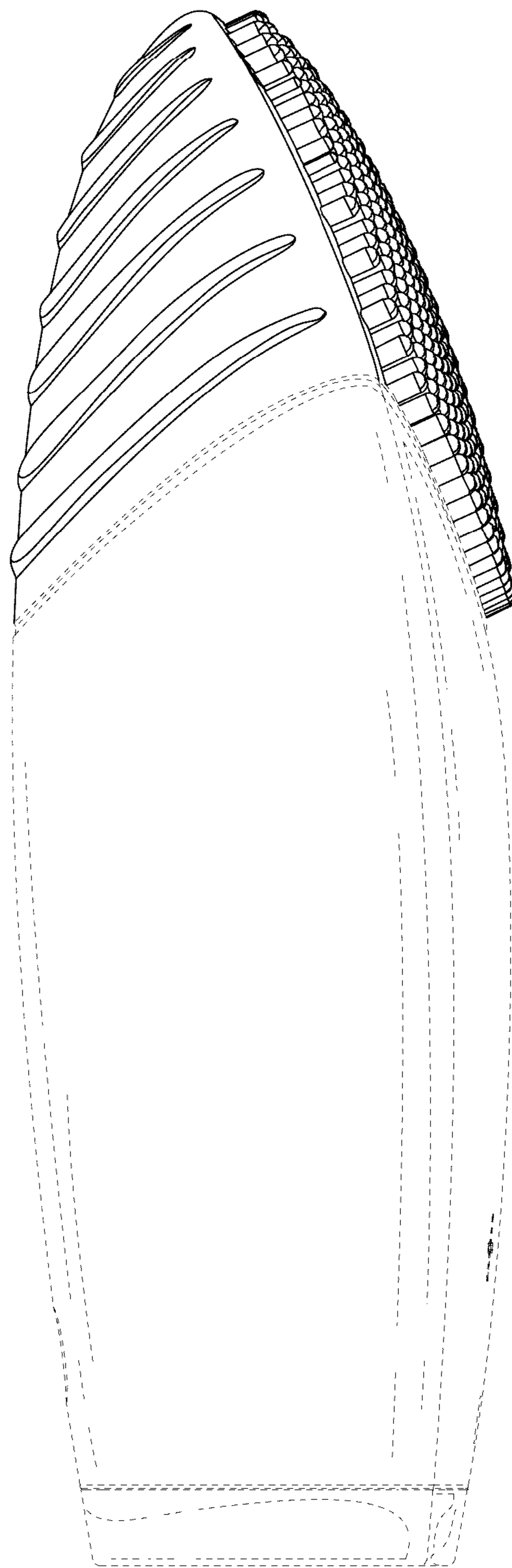

FIG. 44

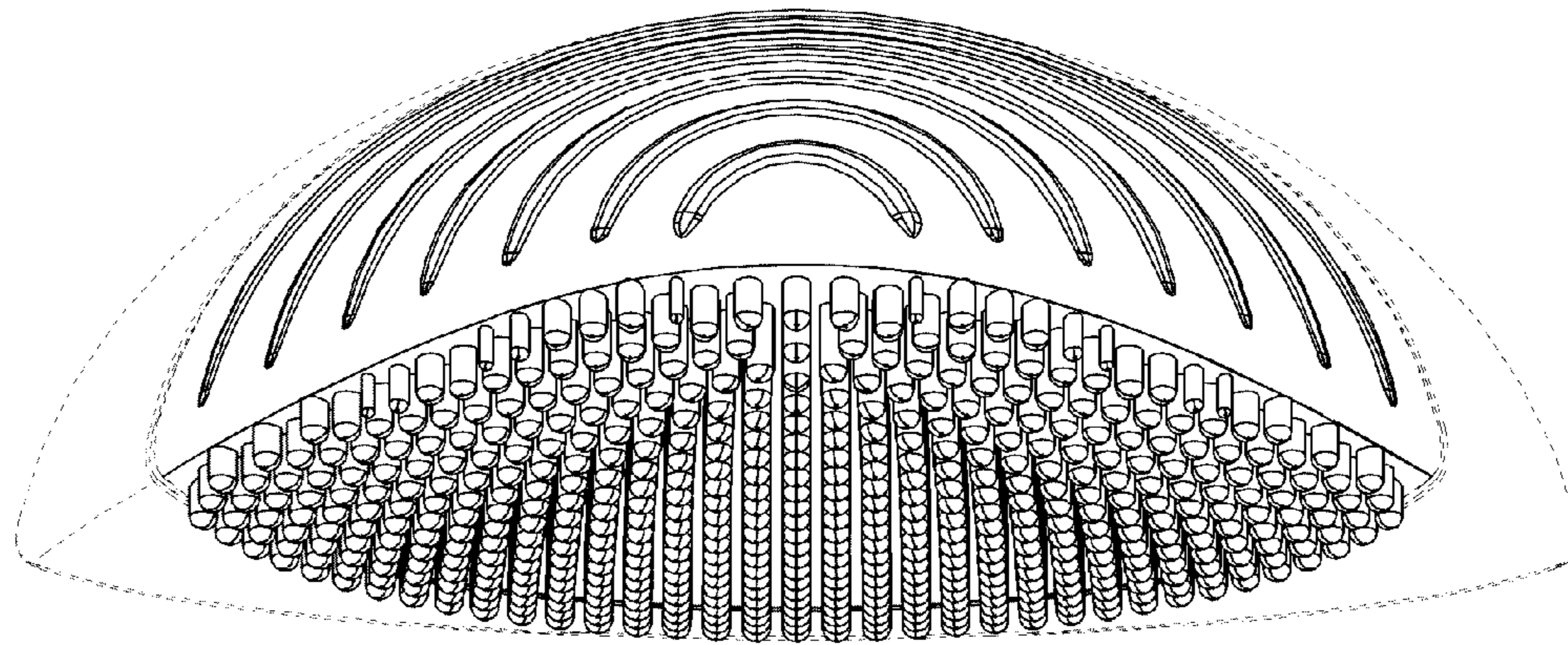

FIG. 45

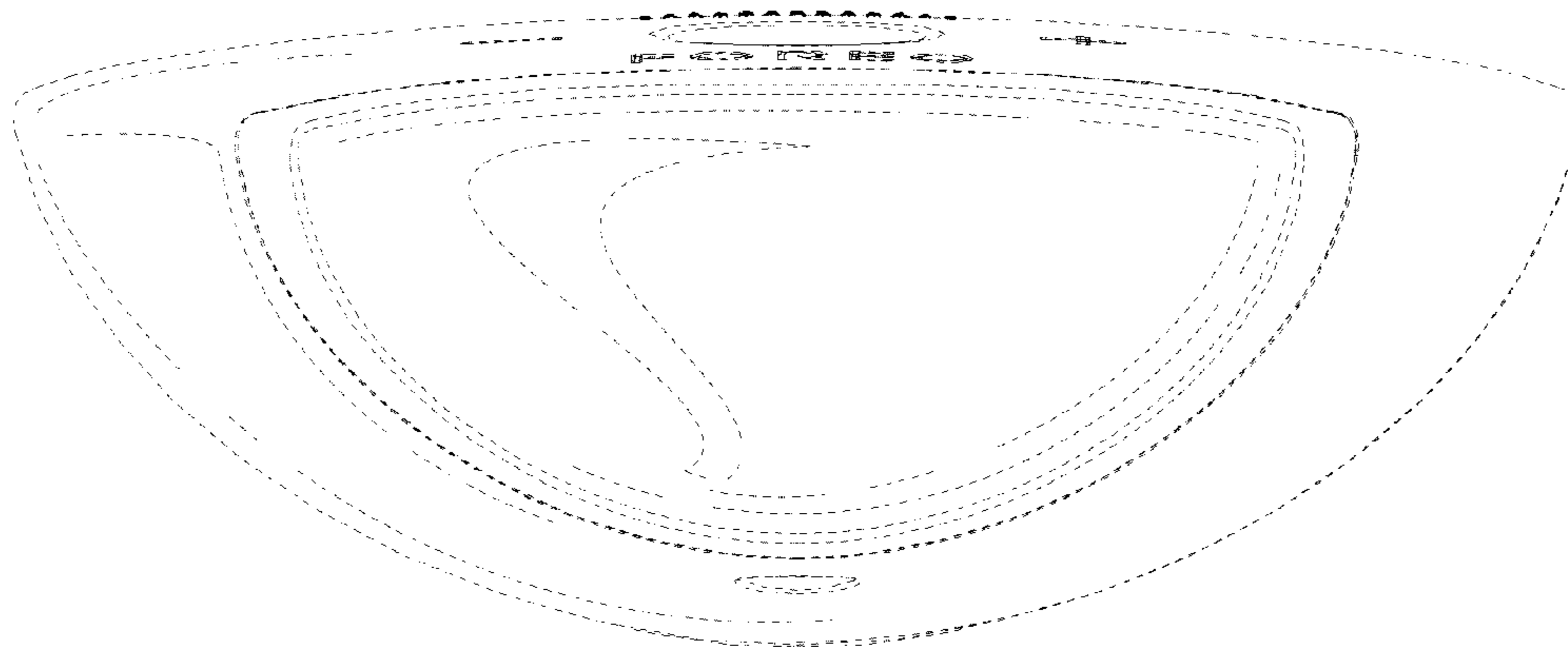

FIG. 46

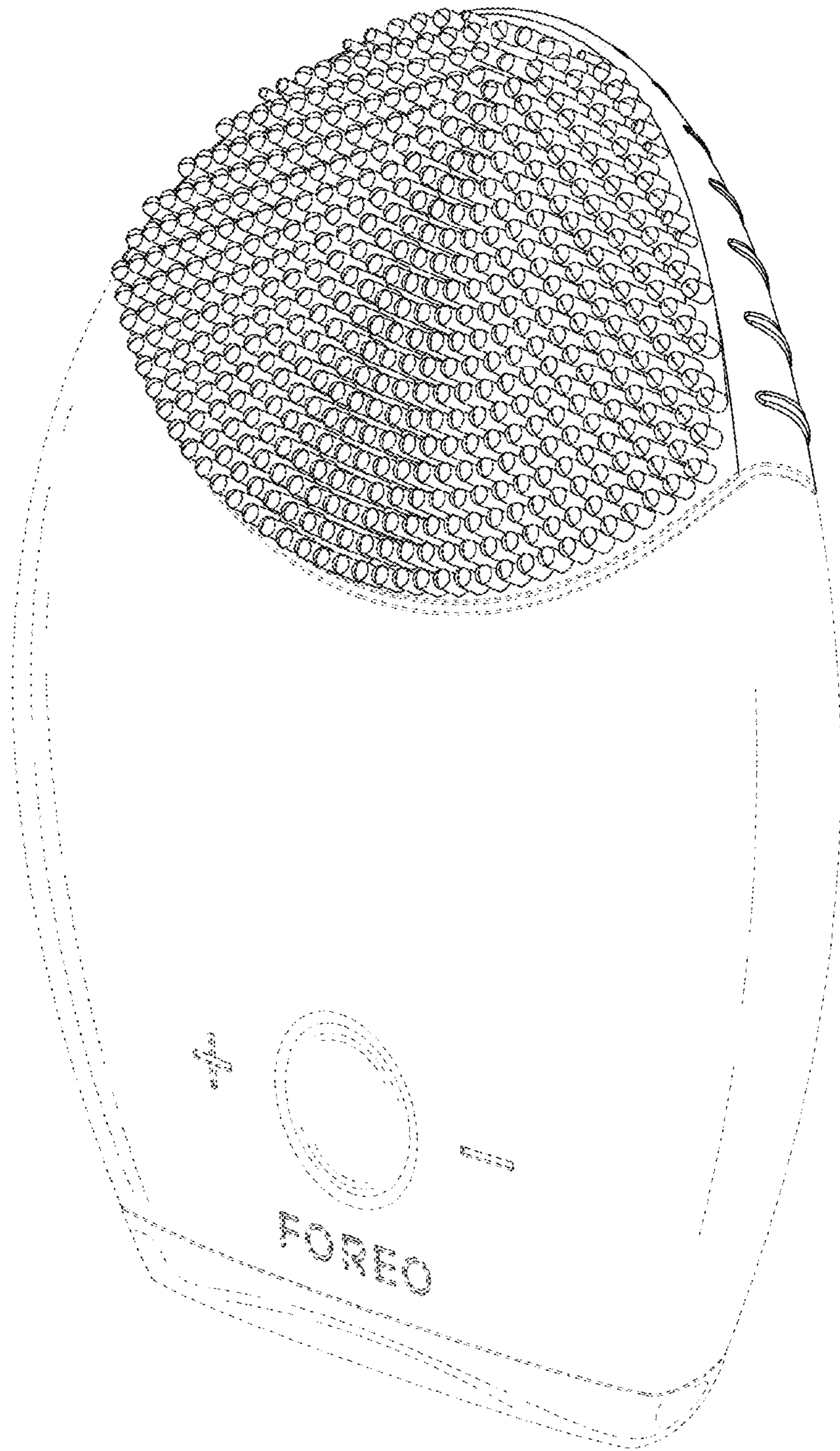

FIG. 47

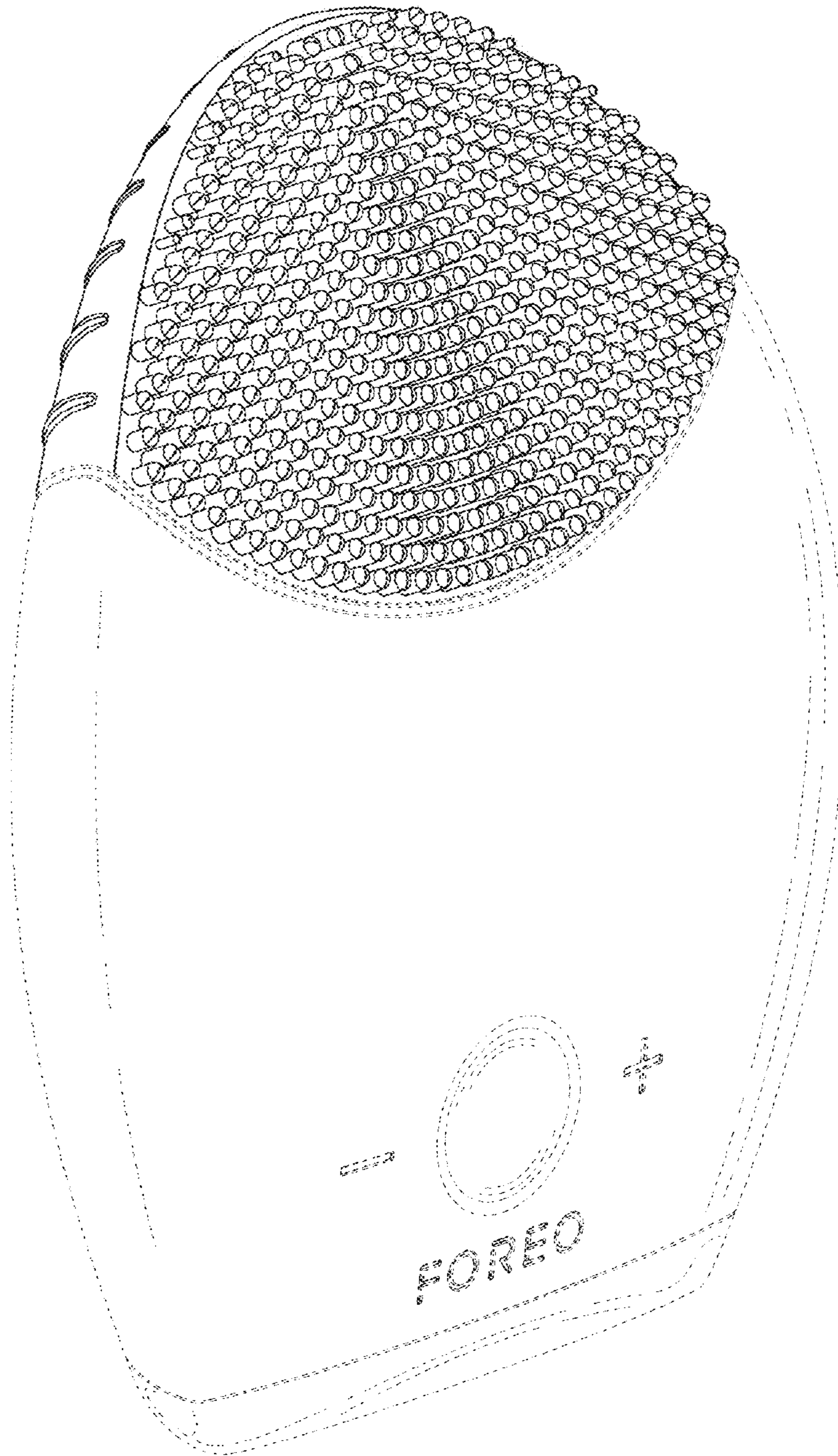

FIG. 48

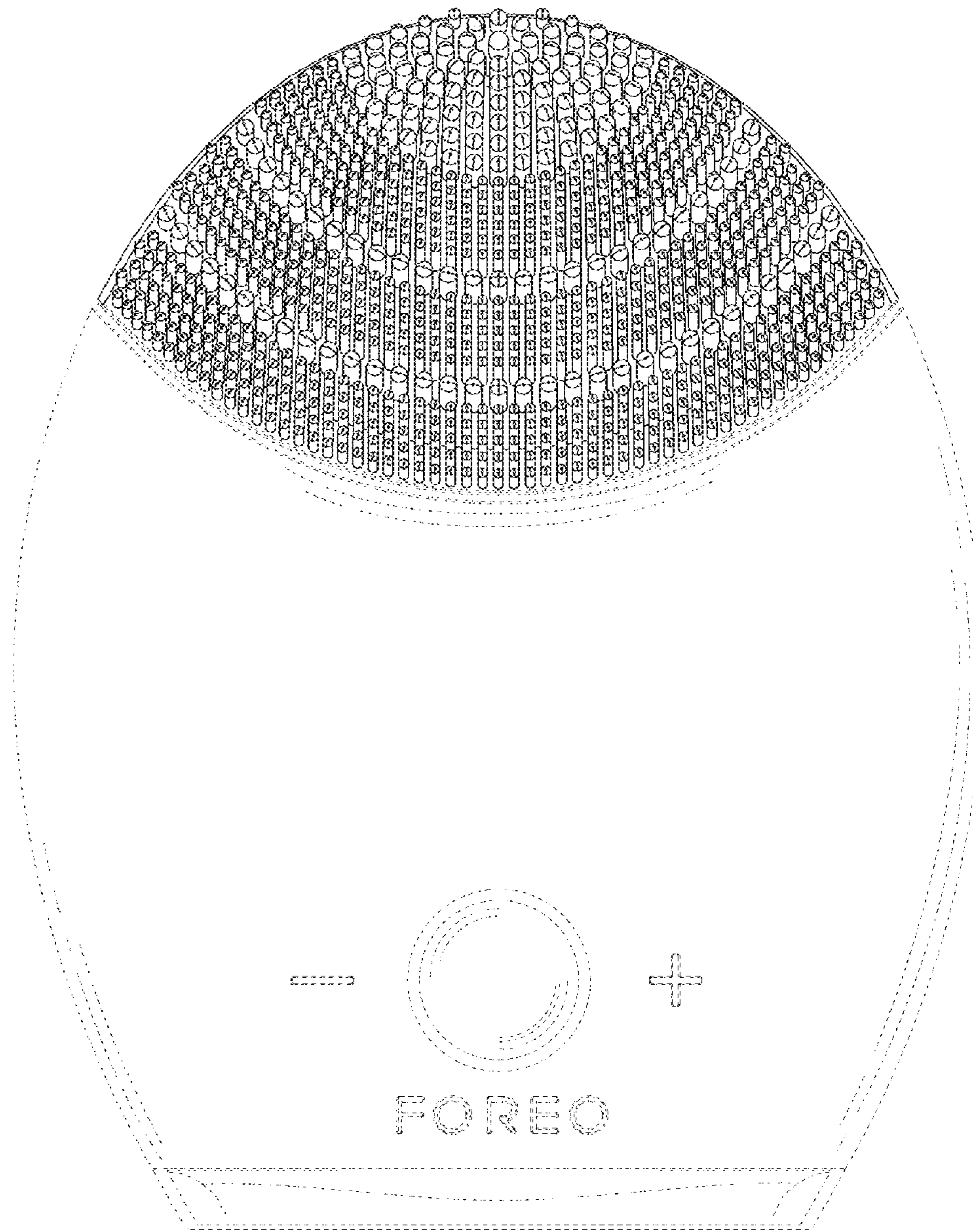

FIG. 49

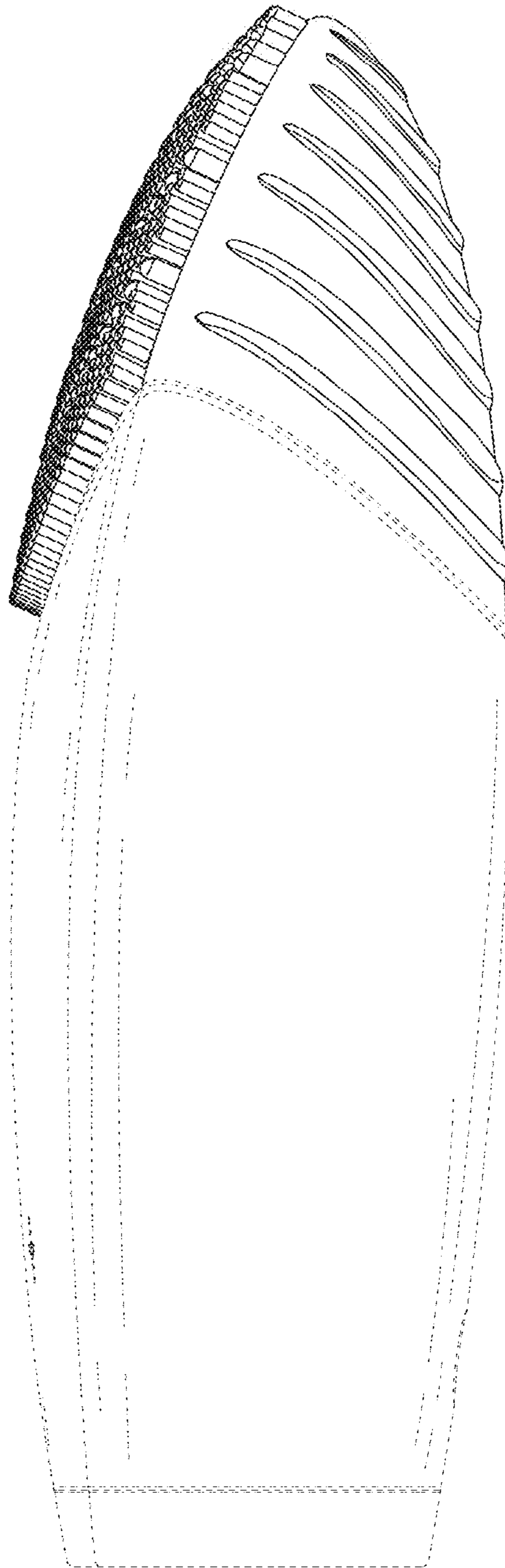

FIG. 50

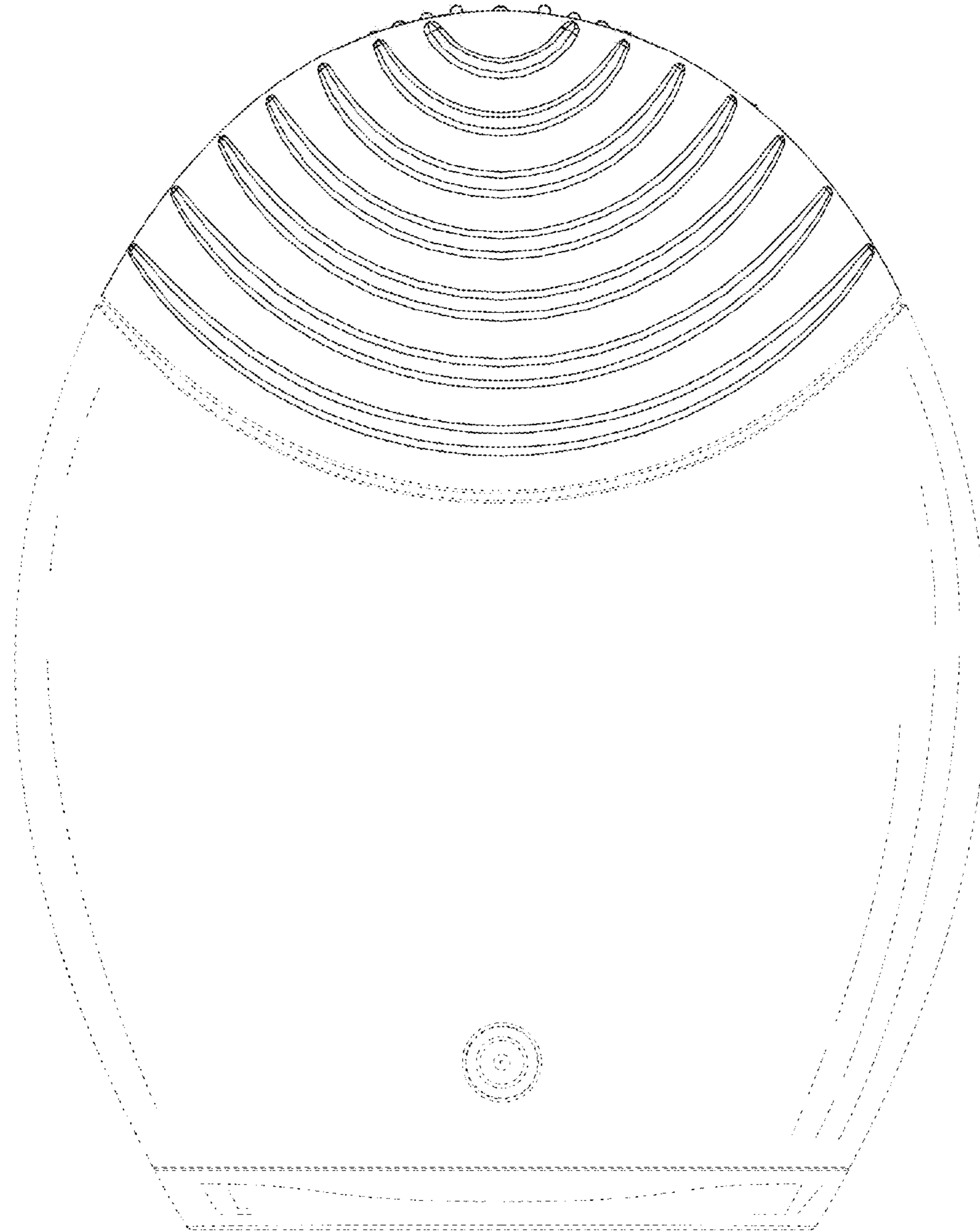

FIG. 51

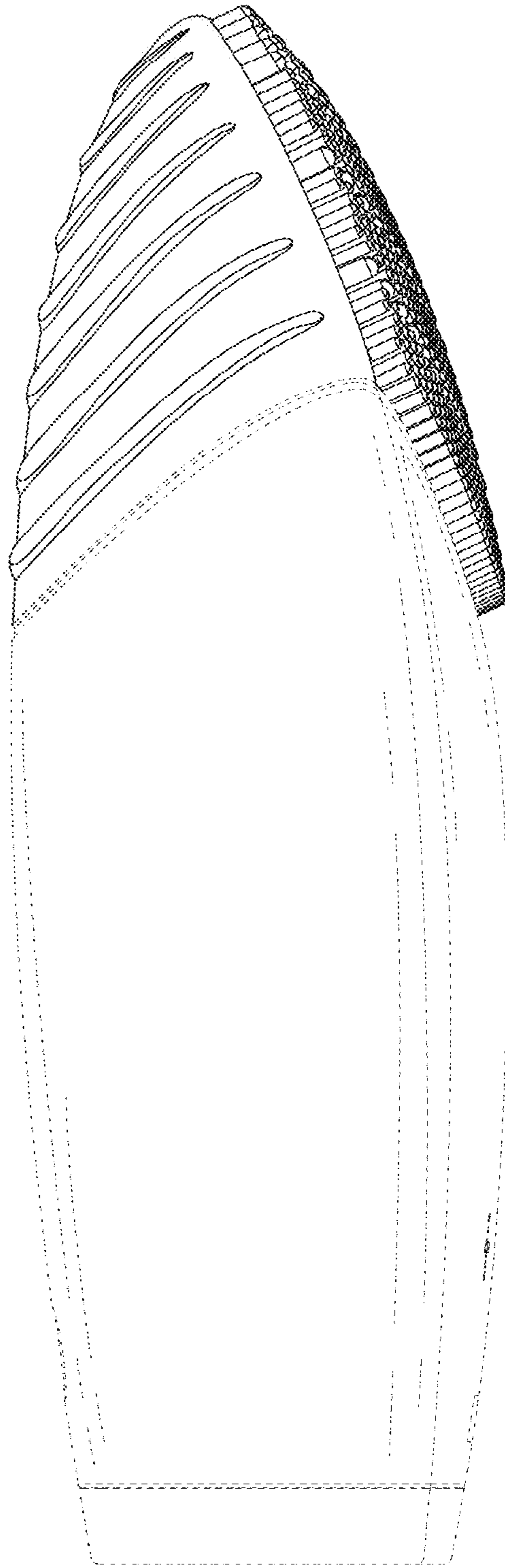

FIG. 52

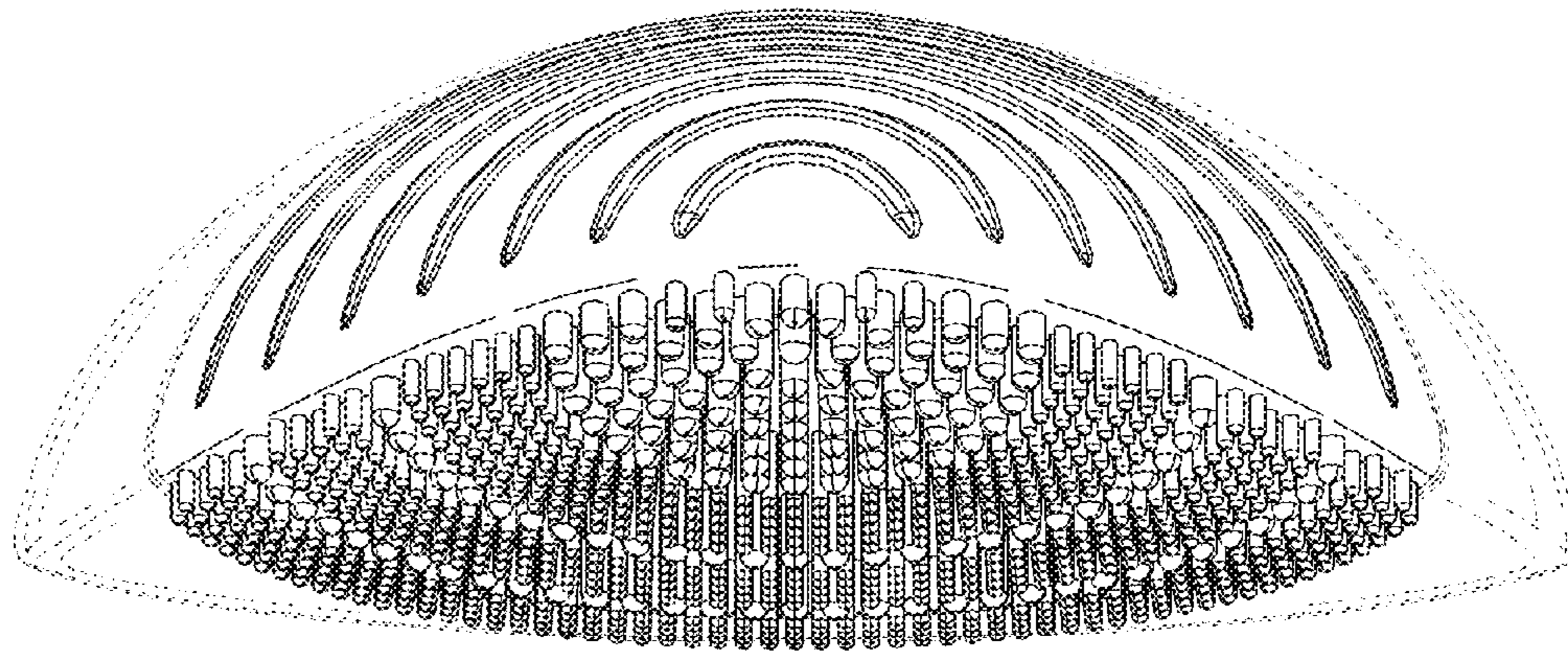

FIG. 53

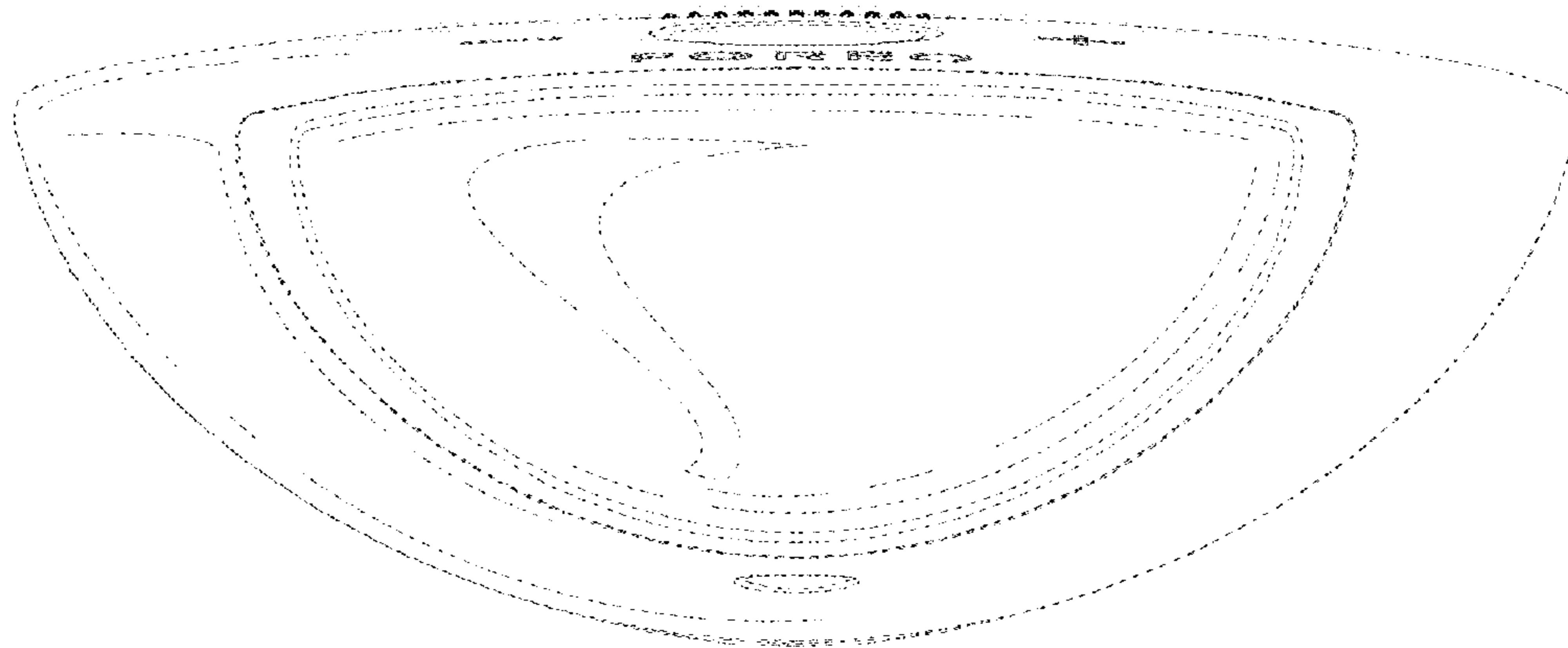

FIG. 54

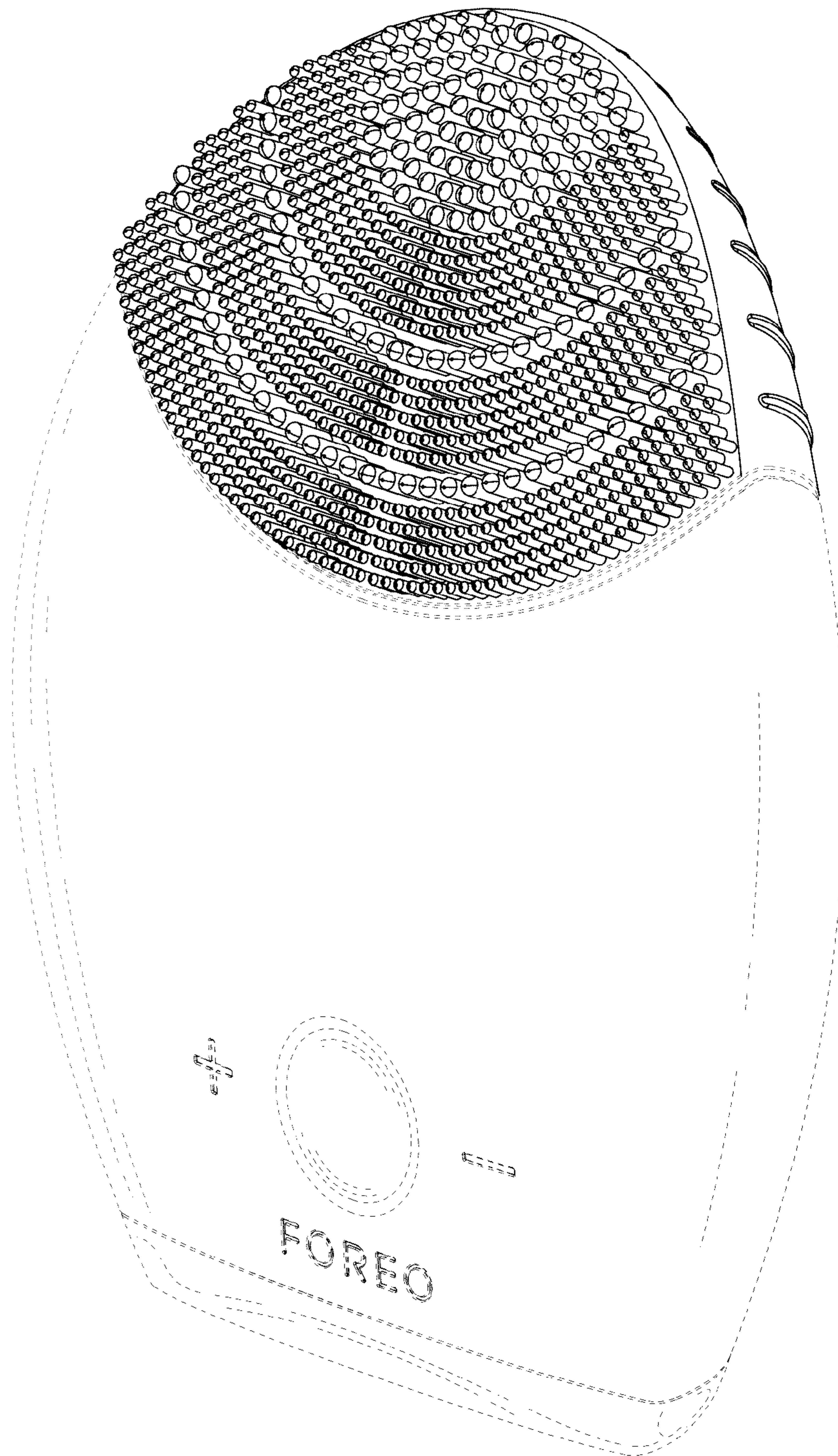

FIG. 55

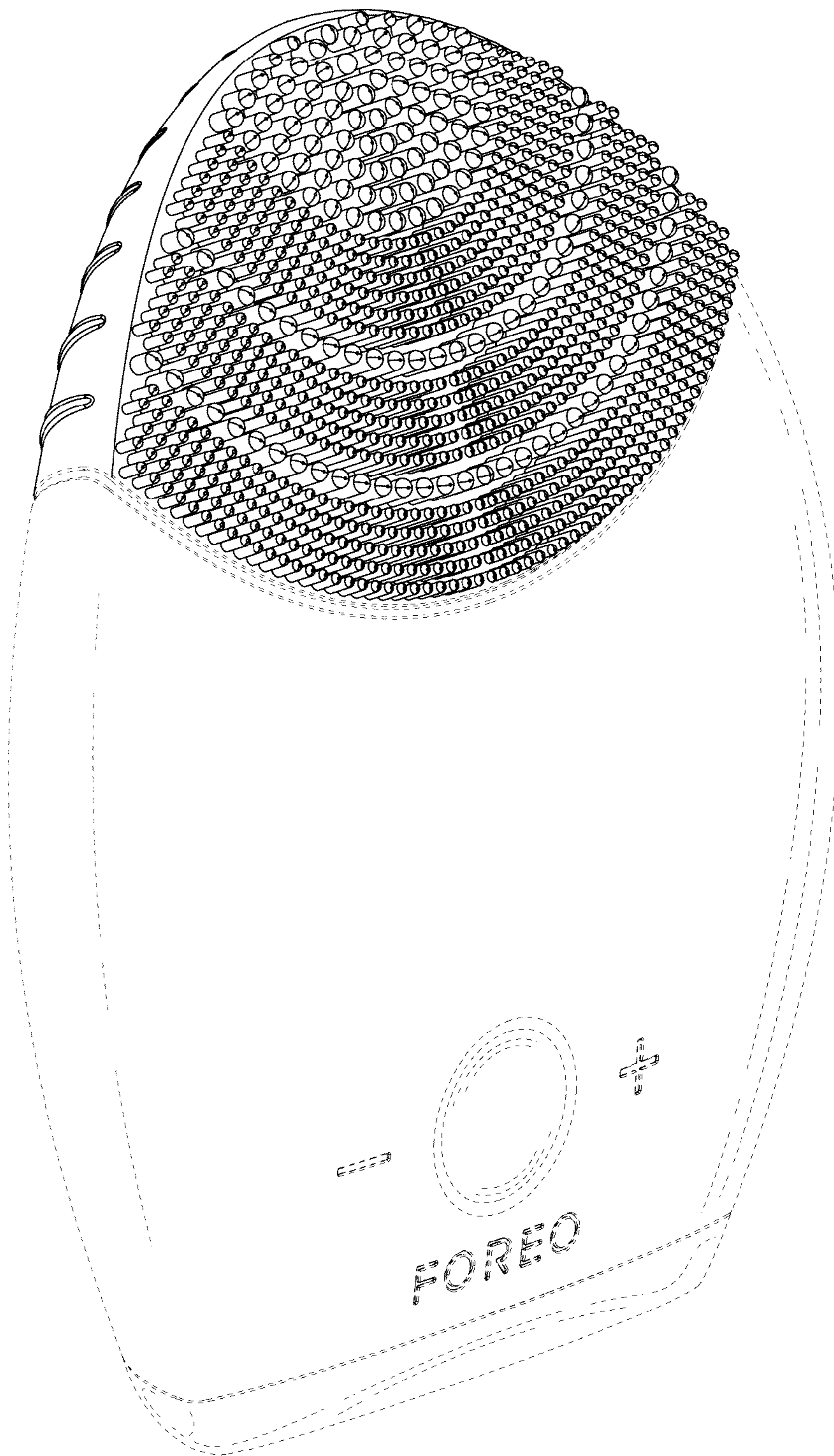

FIG. 56

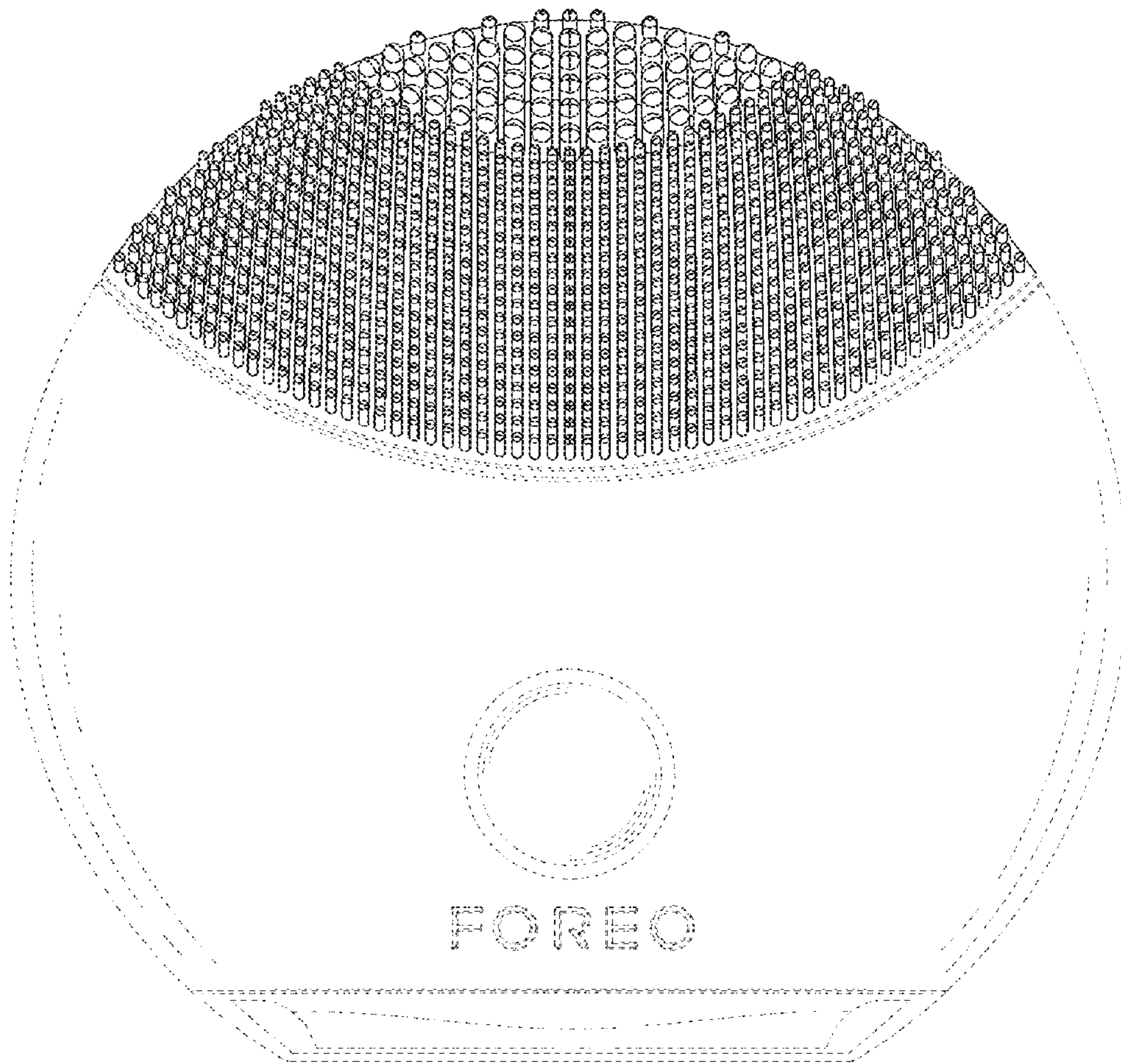

FIG. 57

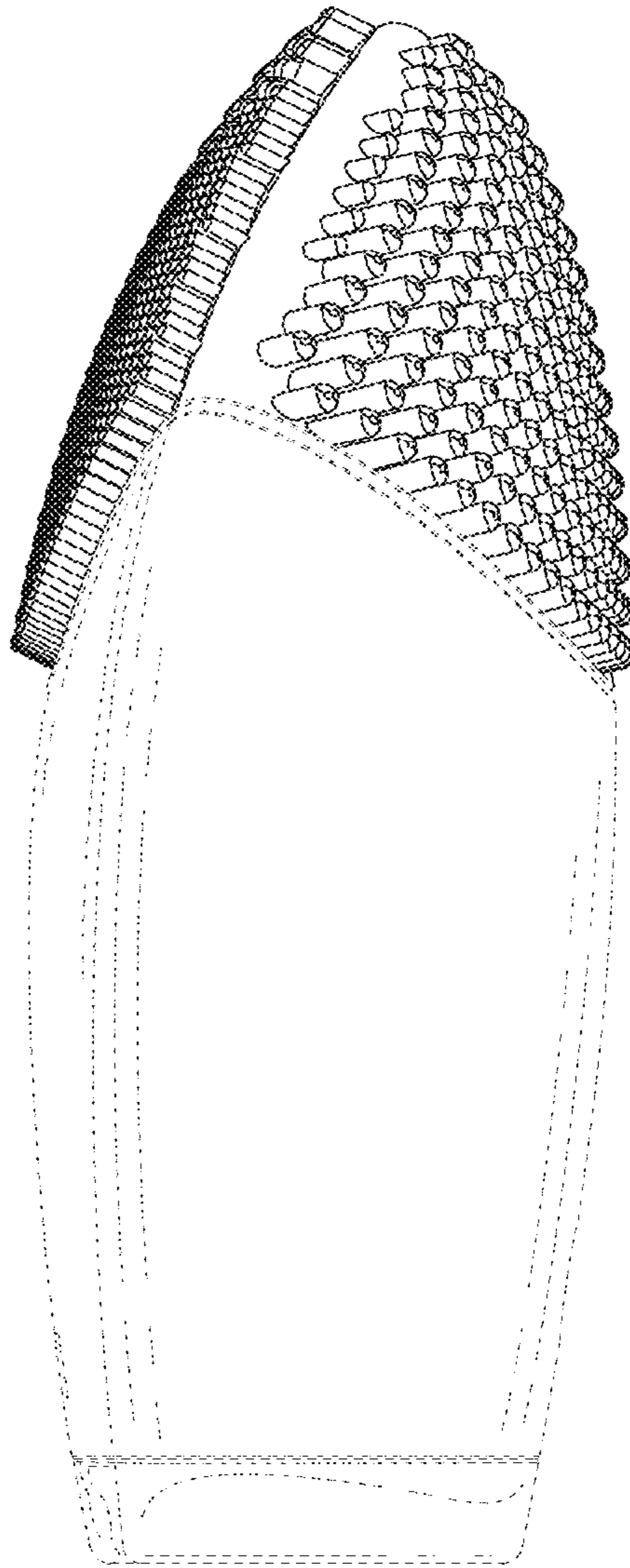

FIG. 58

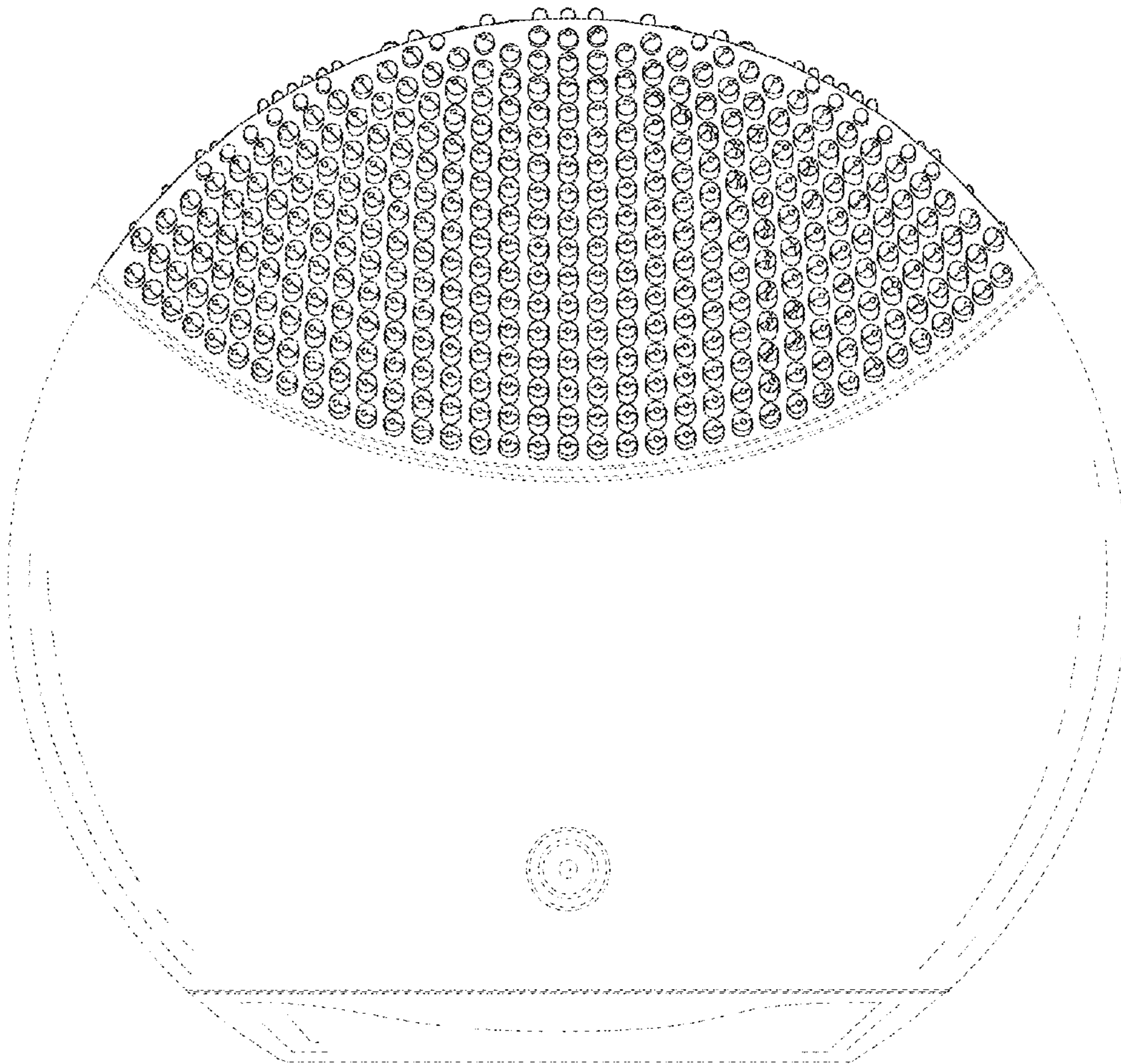

FIG. 59

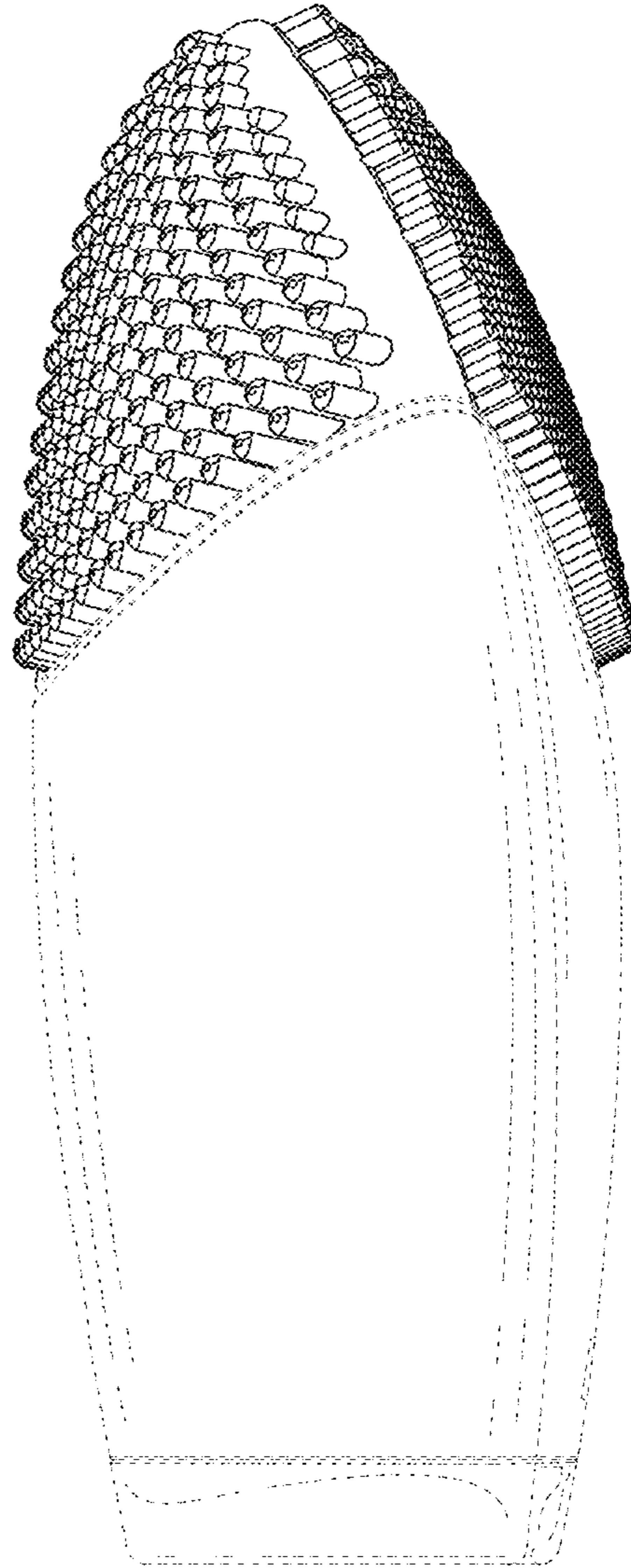

FIG. 60

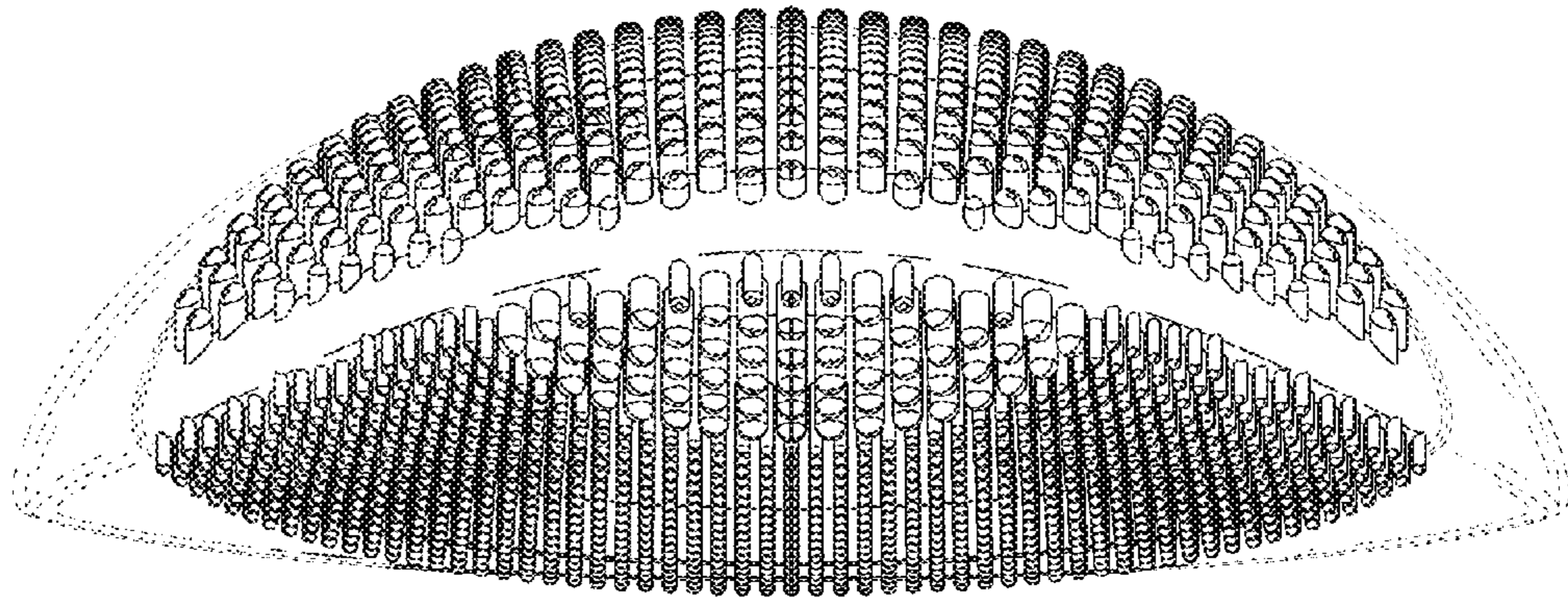

FIG. 61

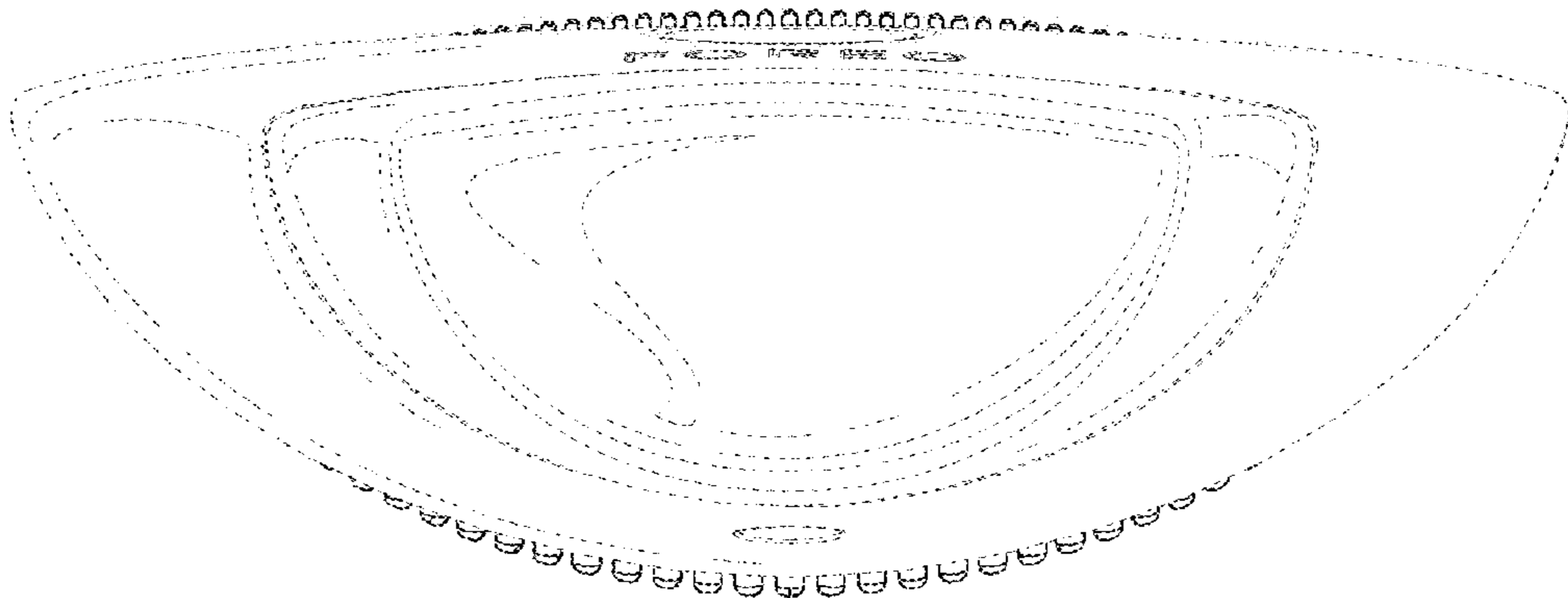

FIG. 62

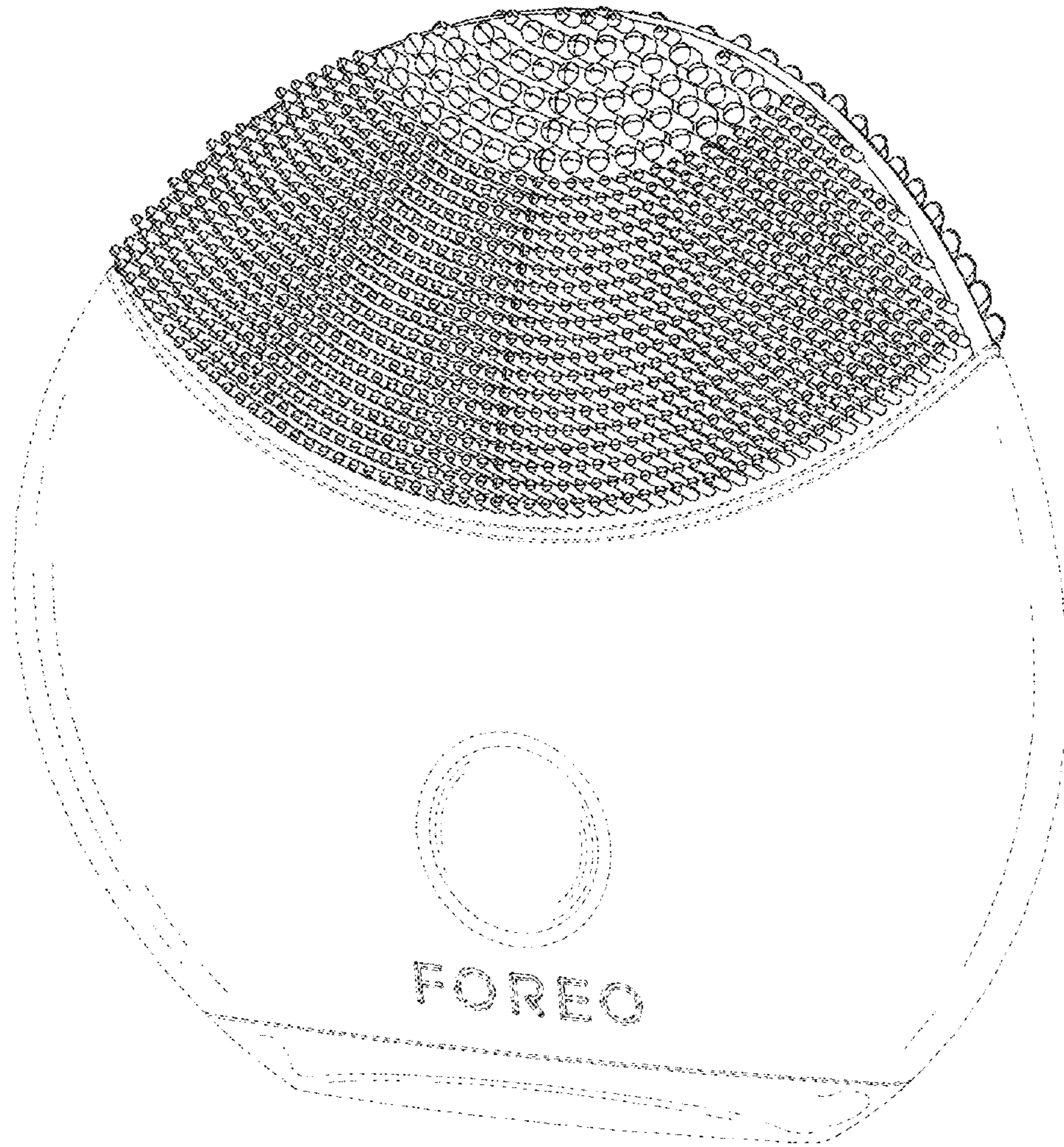

FIG. 63

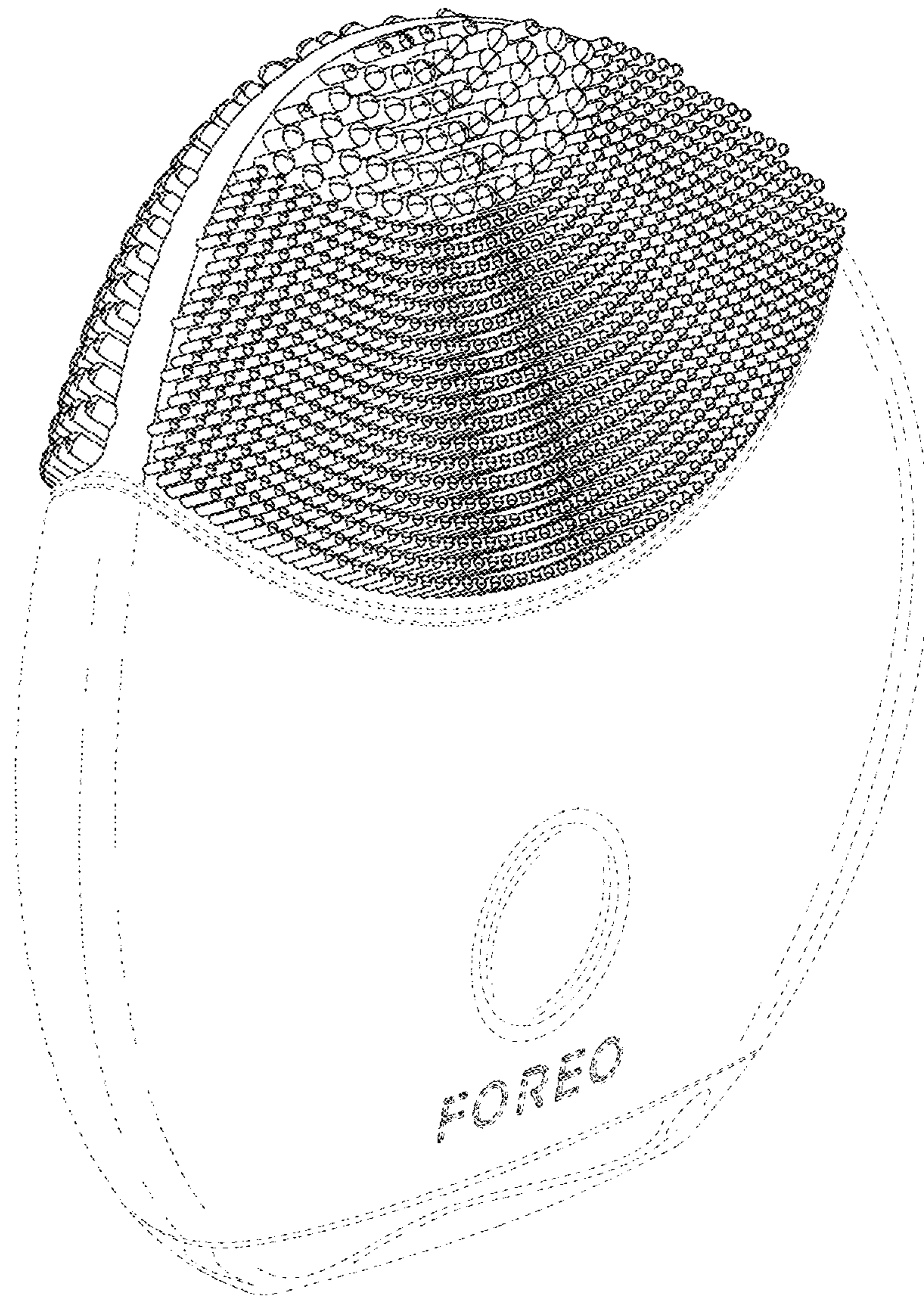

FIG. 64