

US00D769390S

(12) **United States Design Patent** (10) **Patent No.:** **US D769,390 S**
Wang (45) **Date of Patent:** **** Oct. 18, 2016**

(54) **GOLF PRACTICE AID**
(71) Applicant: **Jonathan Wang**, Hayward, CA (US)
(72) Inventor: **Jonathan Wang**, Hayward, CA (US)
(**) Term: **15 Years**
(21) Appl. No.: **29/571,084**
(22) Filed: **Jul. 14, 2016**

D490,492 S * 5/2004 Nemeckay D21/791
6,955,610 B1 10/2005 Czaja et al.
D603,924 S * 11/2009 Troutman D21/791
D627,414 S * 11/2010 Masuda D21/725
D640,764 S * 6/2011 Ikeda D21/791
8,540,584 B1 * 9/2013 Sorenson A63B 69/36
473/219

* cited by examiner

Primary Examiner — Mitchell Siegel
(74) *Attorney, Agent, or Firm* — Maier & Maier, PLLC

(30) **Foreign Application Priority Data**
Apr. 11, 2016 (CN) 2016 3 0118508
(51) **LOC (10) Cl.** **21-02**
(52) **U.S. Cl.**
USPC **D21/791**
(58) **Field of Classification Search**
USPC D21/789, 791
CPC A63B 69/36; A63B 69/3623; A63B
69/3638
See application file for complete search history.

(57) **CLAIM**
The ornamental design for a golf practice aid, as shown and described.

DESCRIPTION

FIG. 1 is a front perspective view of a golf practice aid; FIG. 2 is another front perspective view thereof; FIG. 3 is a front elevation view thereof; FIG. 4 is a rear elevation view thereof; FIG. 5 is a left elevation view thereof; FIG. 6 is a right elevation view thereof; FIG. 7 is a top plan view thereof; FIG. 8 is a bottom plan view thereof; and, FIG. 9 is a front perspective view of a golf practice aid with the sliding element being shown in an alternate position. The broken line showing of portions of the golf practice aid and environment is for illustrative purposes only and forms no part of the claimed design. Portions of the claimed design are shown separated and bound by a bracket to indicate indeterminate length. The appearance of any portion of the article between the break lines forms no part of the claimed design.

(56) **References Cited**
U.S. PATENT DOCUMENTS
D237,515 S * 11/1975 Thiel D21/680
4,027,886 A 6/1977 Katsube
4,664,388 A * 5/1987 Huber A63B 67/20
273/DIG. 20
D326,493 S * 5/1992 Perry D21/791
D329,268 S * 9/1992 Perry D21/791
D405,859 S * 2/1999 Thompson D21/791
D426,607 S * 6/2000 Wurster D21/791
D432,613 S 10/2000 Lewallen, Jr.
D457,929 S * 5/2002 Ciesar D21/725
D485,325 S * 1/2004 Rohan-Weaver D21/789
D486,198 S * 2/2004 Rohan-Weaver D21/791

1 Claim, 6 Drawing Sheets

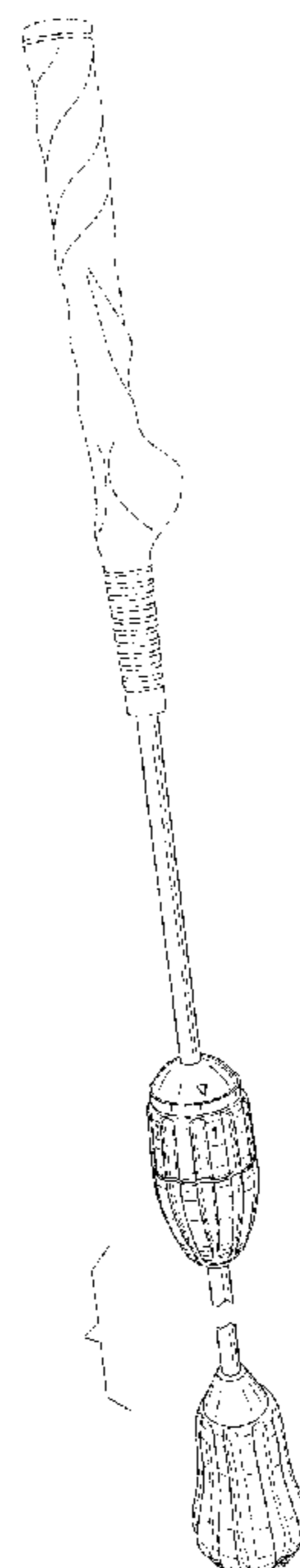

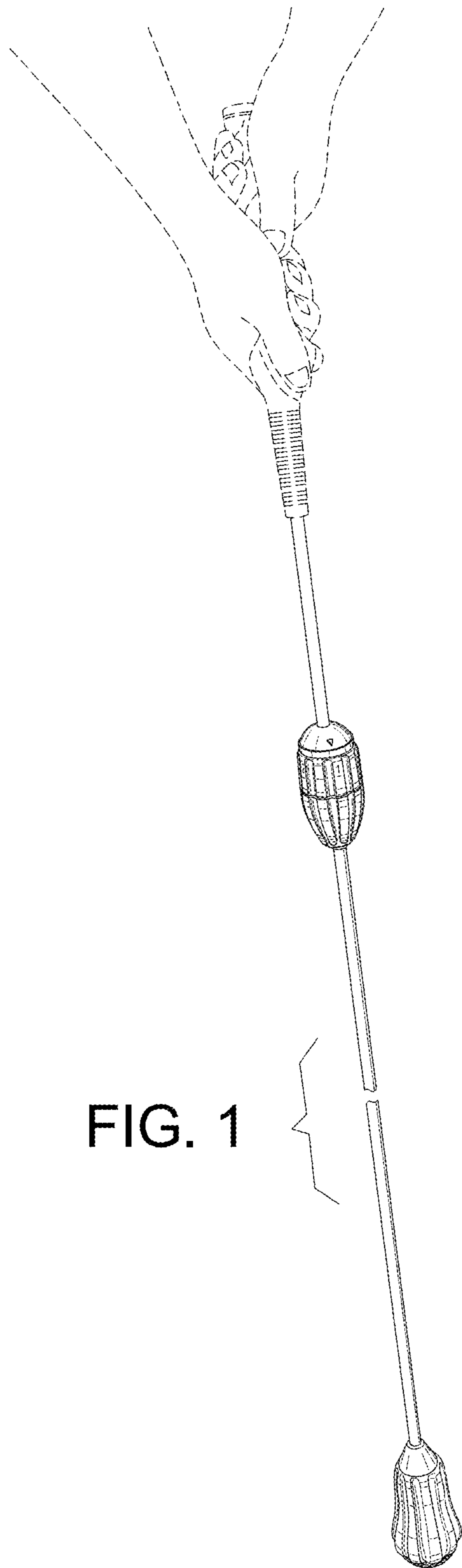
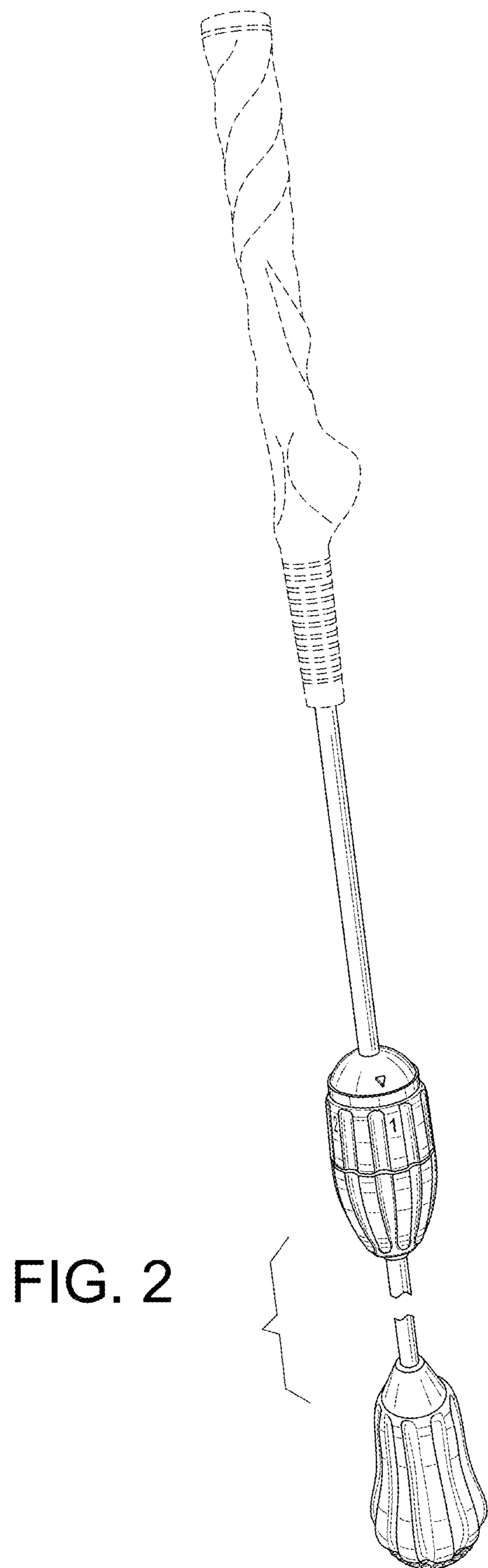
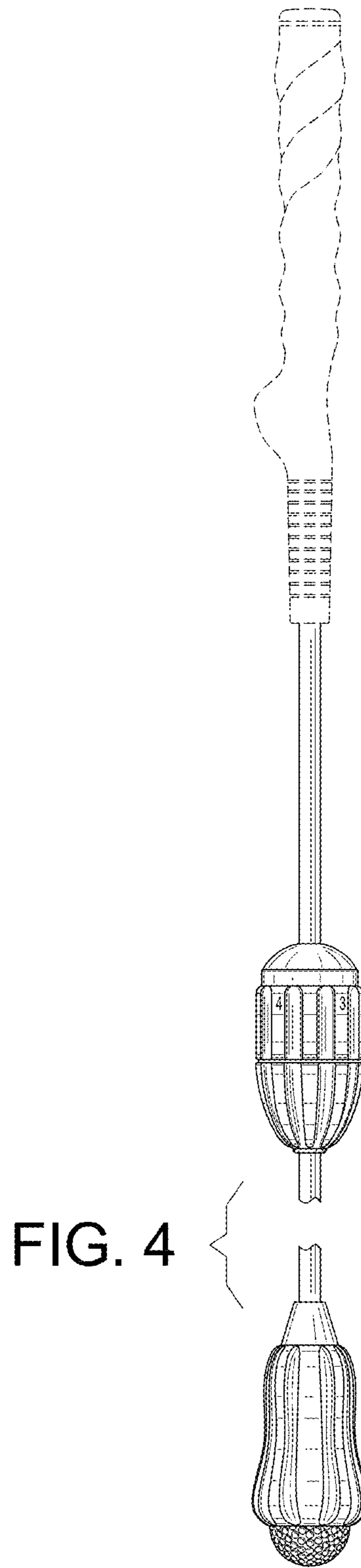
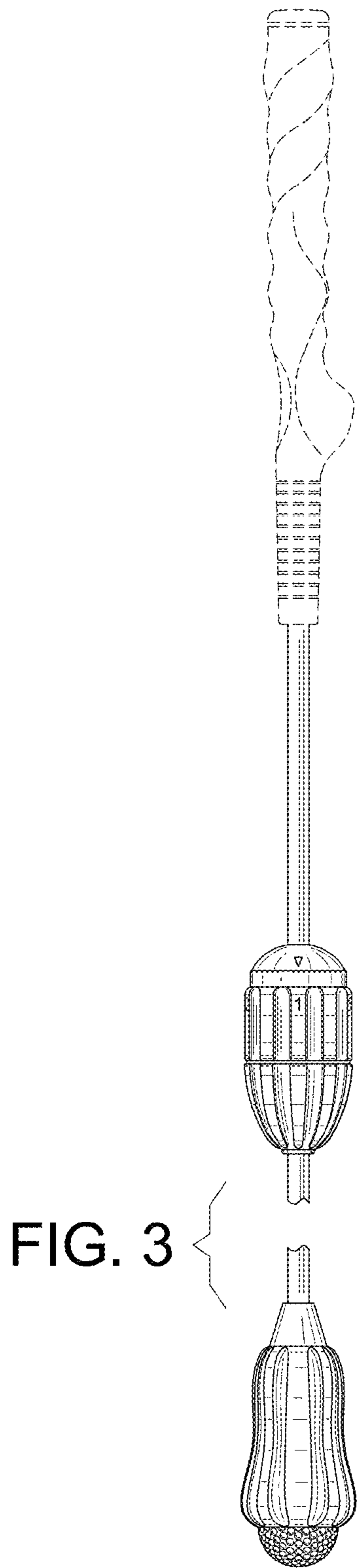

FIG. 1





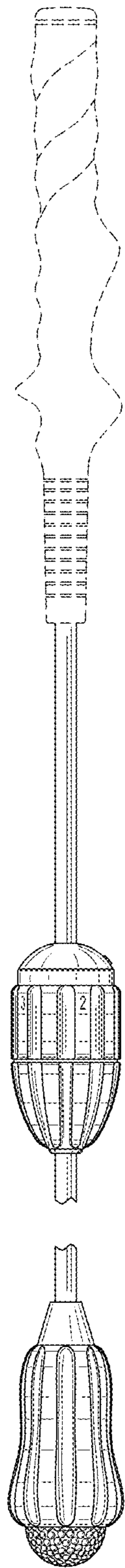

FIG. 5

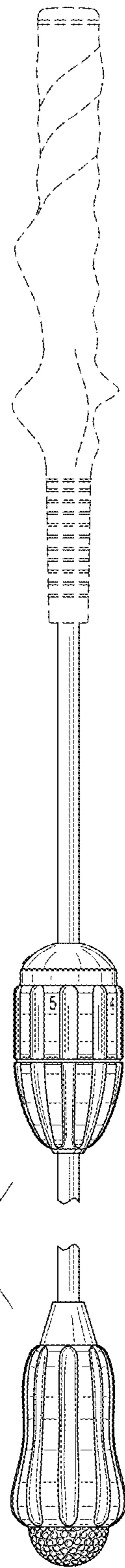

FIG. 6

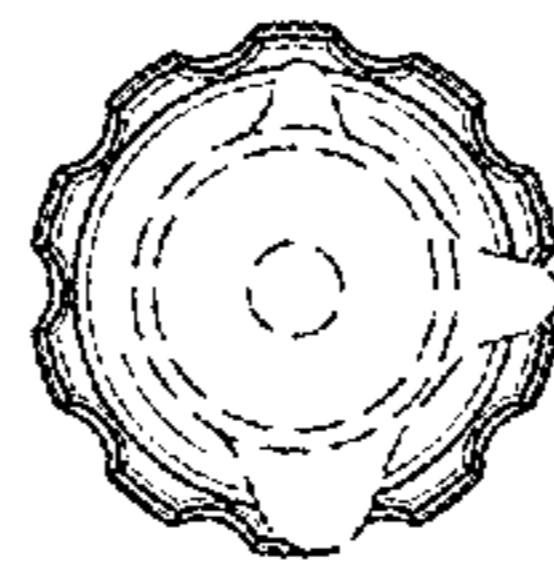

FIG. 7

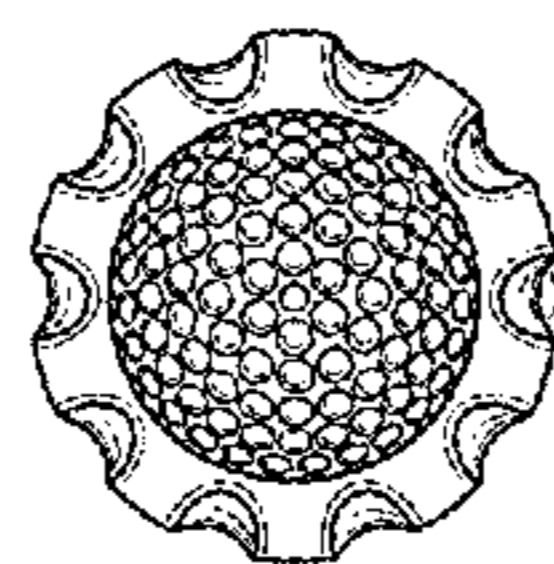

FIG. 8

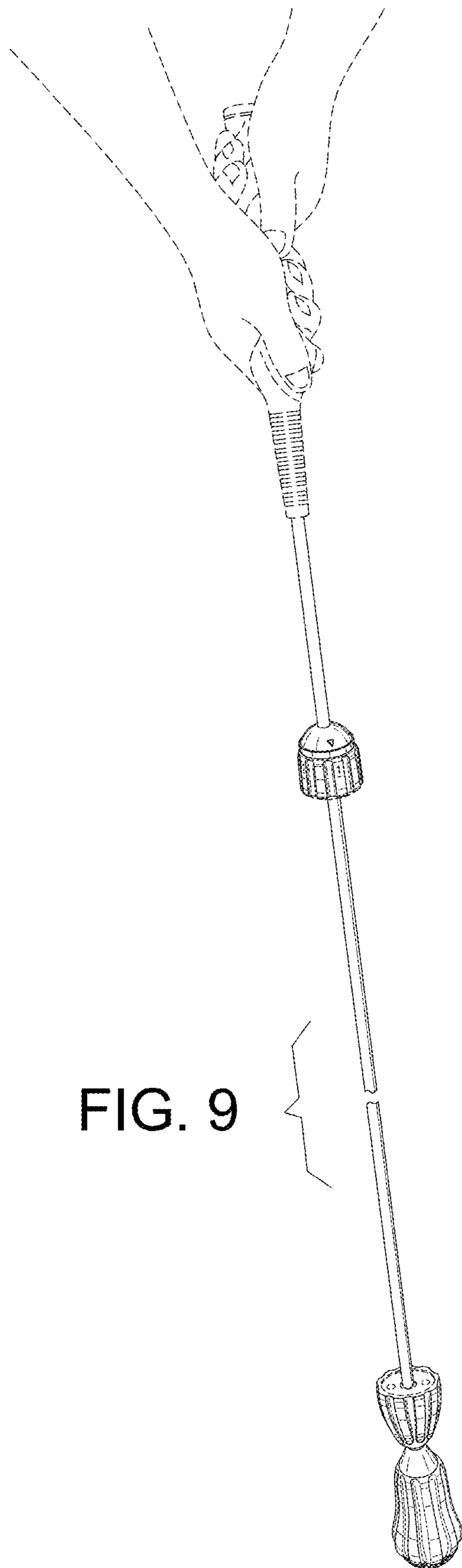

FIG. 9