



US00D769254S

(12) **United States Design Patent**
Nook et al.

(10) **Patent No.:** **US D769,254 S**
(45) **Date of Patent:** **** Oct. 18, 2016**

(54) **DISPLAY PANEL OR SCREEN WITH ANIMATED USER INTERFACE**

(71) Applicant: **THE NOCO COMPANY**, Glenwillow, OH (US)

(72) Inventors: **Jonathan Lewis Nook**, Gates Mills, OH (US); **William Knight Nook, Sr.**, Shaker Heights, OH (US); **James Richard Stanfield**, Peoria, AZ (US); **Derek Michael Underhill**, Tempe, AZ (US)

(73) Assignee: **THE NOCO COMPANY**, Glenwillow, OH (US)

(**) Term: **14 Years**

(21) Appl. No.: **29/488,029**

(22) Filed: **Apr. 15, 2014**

(51) **LOC (10) Cl.** **14-04**

(52) **U.S. Cl.**

USPC **D14/485**

(58) **Field of Classification Search**

USPC D14/485-495

CPC G06F 3/0481; G06F 3/0482; G06F 3/04817; G06F 3/04883; G06F 3/04815; G06F 3/0485; G06F 3/04886

See application file for complete search history.

(56) **References Cited**

U.S. PATENT DOCUMENTS

D523,443 S * 6/2006 Hone D14/488
D544,495 S * 6/2007 Evans D14/488

(Continued)

OTHER PUBLICATIONS

U.S. Trademark Application No. 86030590 filed on Aug. 6, 2013, including drawing and sample.

Primary Examiner — Deanna L Pratt

(74) *Attorney, Agent, or Firm* — Vorys, Sater, Seymour and Pease LLP; William L. Klima

(57) **CLAIM**

The ornamental design for a display panel or screen with an animated user interface, as shown and described.

DESCRIPTION

The patent file contains at least one drawing executed in color. Copies of this patent with color drawings will be provided by the Office upon request and payment of the necessary fee.

FIG. 1 is a front view of a first image of a display or screen with animated user interface;

FIG. 2 is a front view of a second image thereof.

FIG. 3 is a front view of a third image thereof;

FIG. 4 is a front view of a fourth image thereof;

FIG. 5 is a front view of a fifth image thereof;

FIG. 6 is a front view of a sixth image thereof;

FIG. 7 is a front view of a seventh image thereof;

FIG. 8 is a front view of an eight image thereof;

FIG. 9 is a front view of a ninth image thereof;

FIG. 10 is a front view of a tenth image thereof;

FIG. 11 is a front view of an eleventh image thereof;

FIG. 12 is a front view of a twelfth image thereof;

FIG. 13 is a front view of a thirteenth image thereof;

FIG. 14 is a front view of a fourteenth image thereof;

FIG. 15 is a front view of a fifteenth image thereof;

FIG. 16 is a front view of a sixteenth image thereof;

FIG. 17 is a front view of a seventeenth image thereof;

FIG. 18 is a front view of an eighteenth image thereof;

FIG. 19 is a front view of a nineteenth image thereof;

FIG. 20 is a front view of a twentieth image thereof;

FIG. 21 is a front view of a twenty first image thereof;

FIG. 22 is a front view of a twenty second image thereof;

FIG. 23 is a front view of a twenty third image thereof;

FIG. 24 is a front view of a twenty fourth image thereof;

FIG. 25 is a front view of a twenty fifth image thereof;

FIG. 26 is a front view of a twenty sixth image thereof;

FIG. 27 is a front view of a twenty seventh image thereof;

FIG. 28 is a front view of a twenty eighth image thereof;

FIG. 29 is a front view of a twenty ninth image thereof;

FIG. 30 is a front view of a thirtieth image thereof;

FIG. 31 is a front view of a thirty first image thereof; and,

FIG. 32 is a front view of a thirty second image thereof.

The appearance of the display or screen with animated user interface transitions sequentially between the images shown in FIGS. 1 thru 32. The process or period in which an image transitions to another forms no part of the claimed design. The broken line showing of a display panel or screen in the Figures form no part of the claimed design.

1 Claim, 6 Drawing Sheets
(6 of 6 Drawing Sheet(s) Filed in Color)

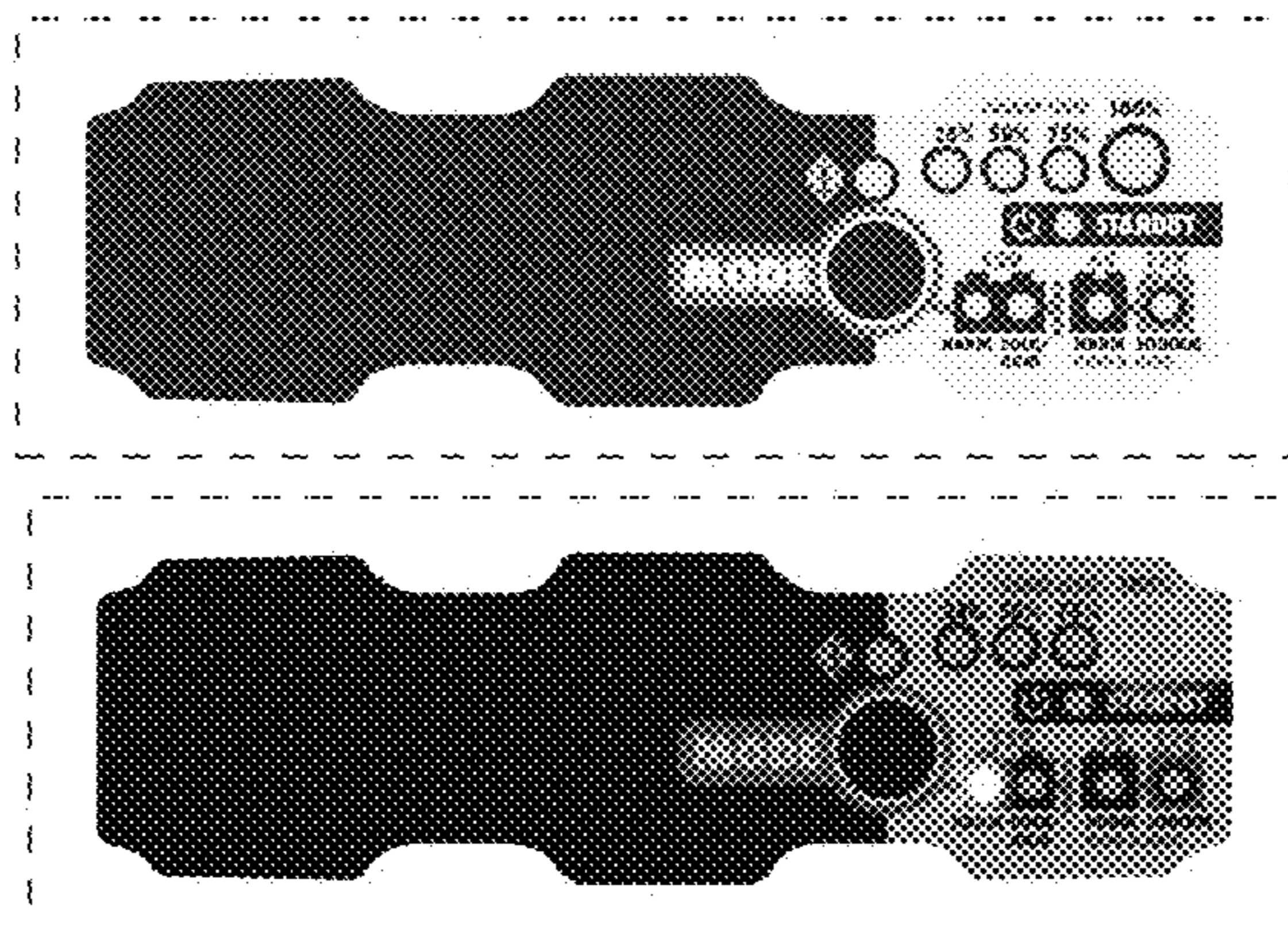

US D769,254 S

Page 2

(56)

References Cited

U.S. PATENT DOCUMENTS

D589,052 S *	3/2009	Tomizawa	D14/487	
D667,443 S *	9/2012	Phelan	D14/492	* cited by examiner
D682,315 S *	5/2013	Voreis	D14/493	
D724,604 S *	3/2015	Ishimoto	D14/485	
D754,194 S *	4/2016	Su	D14/489	

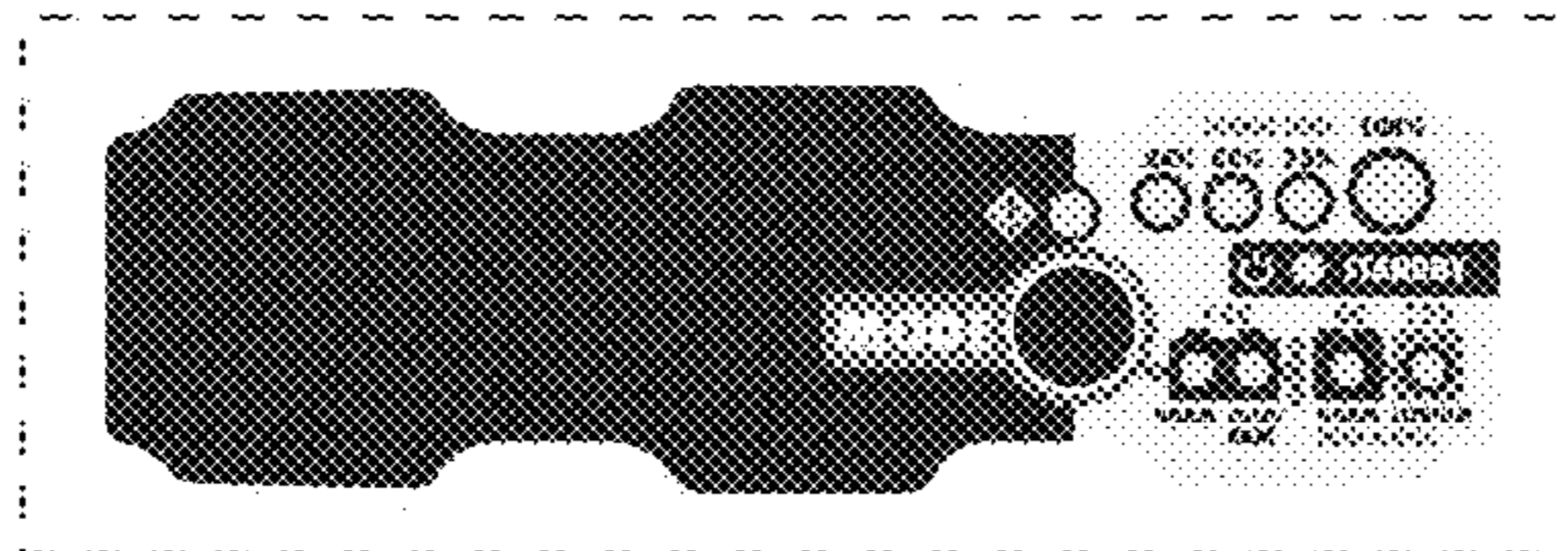

FIG. 1

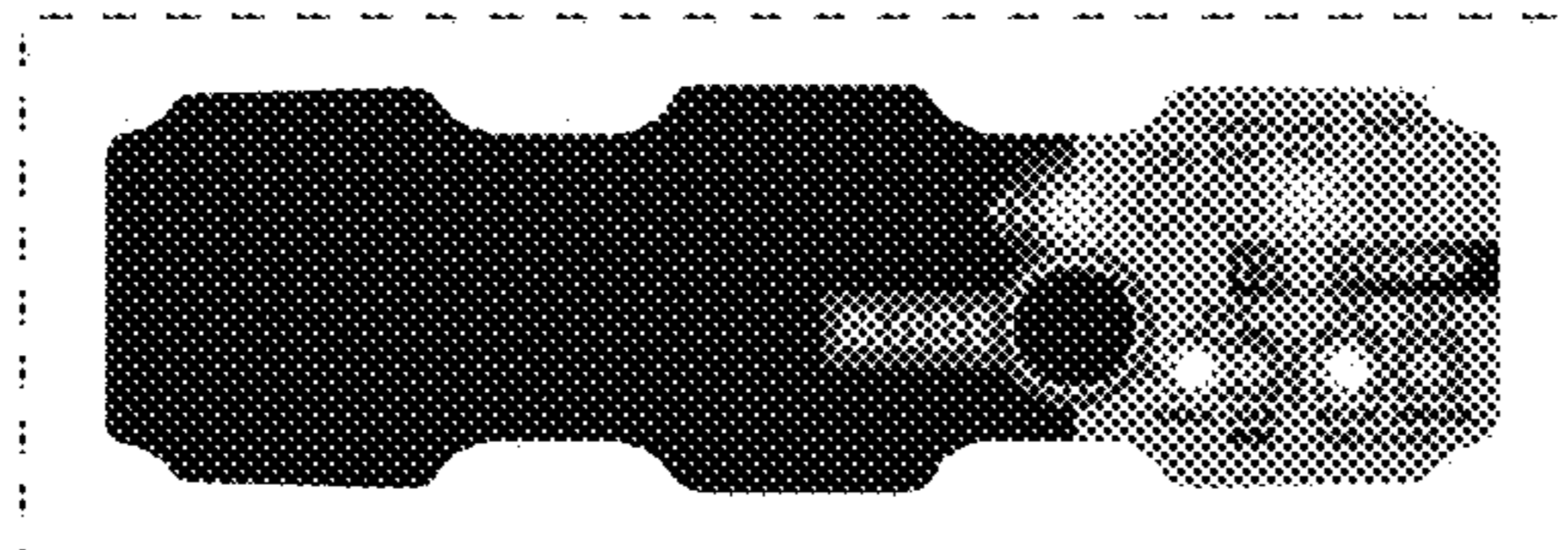

FIG. 2

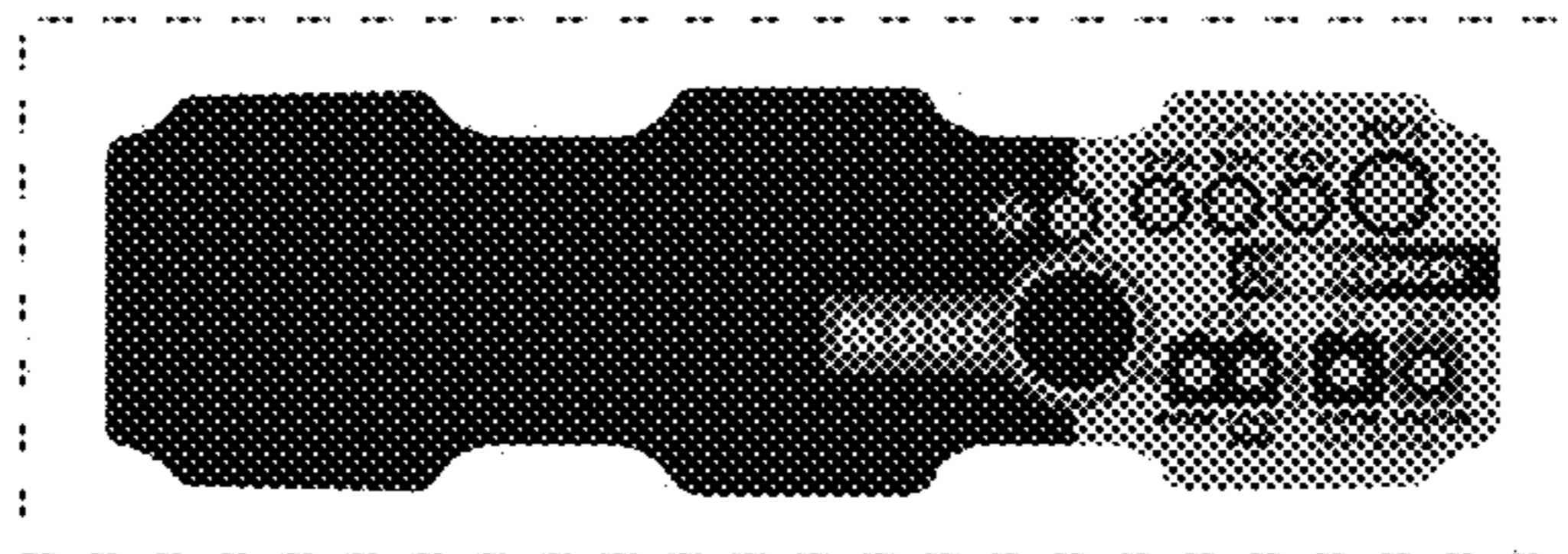

FIG. 3

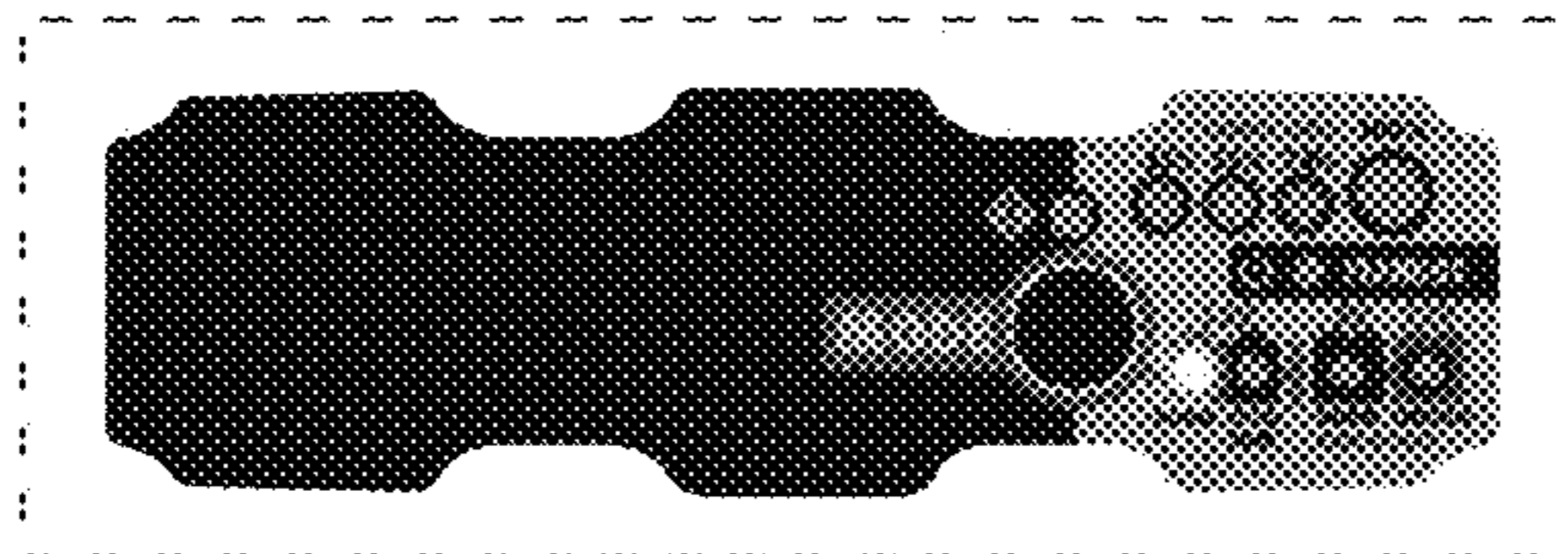

FIG. 4

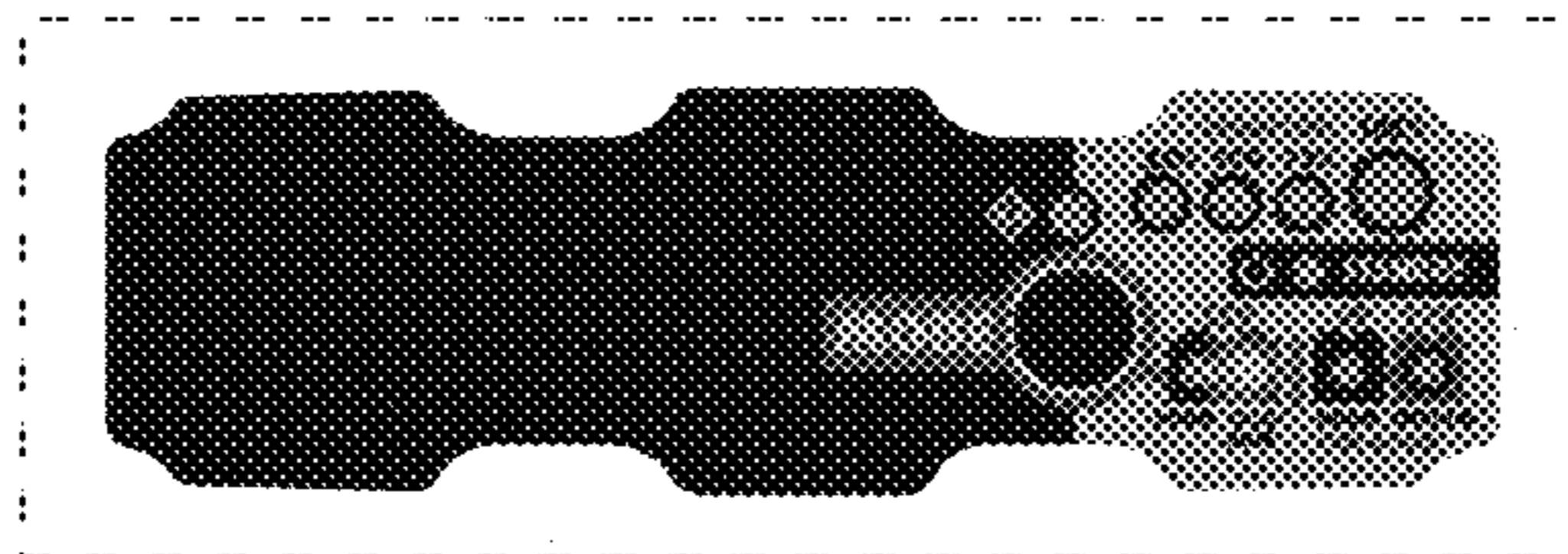

FIG. 5

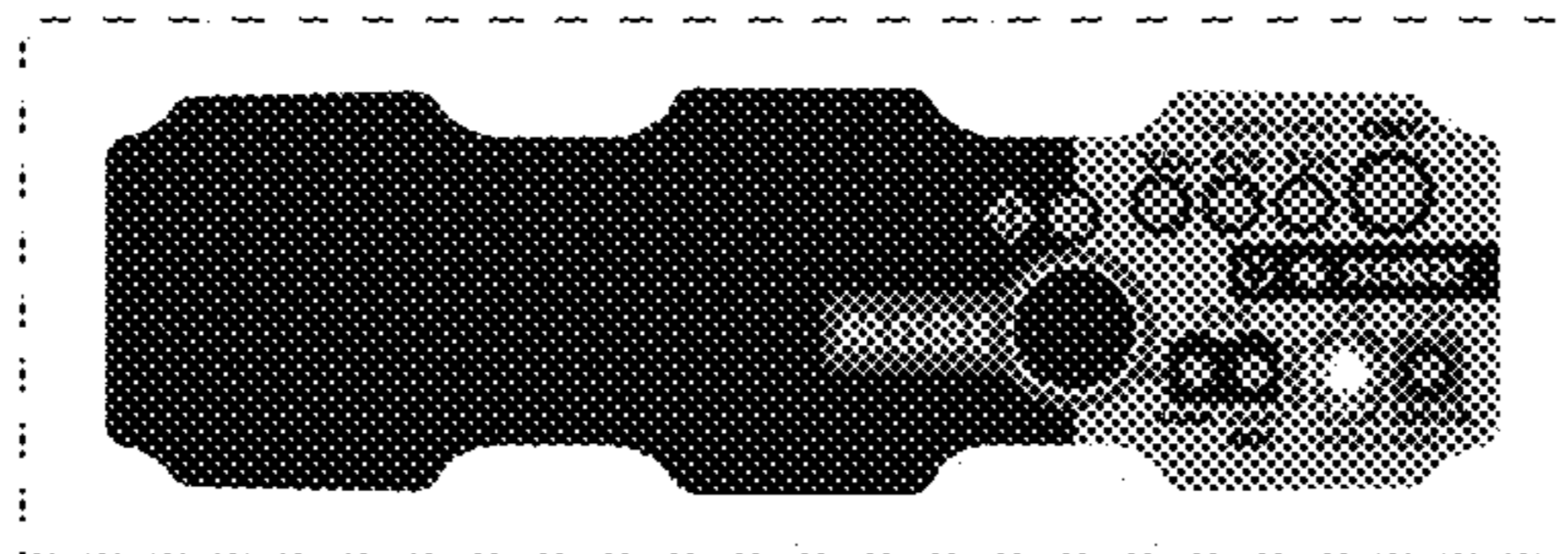

FIG. 6

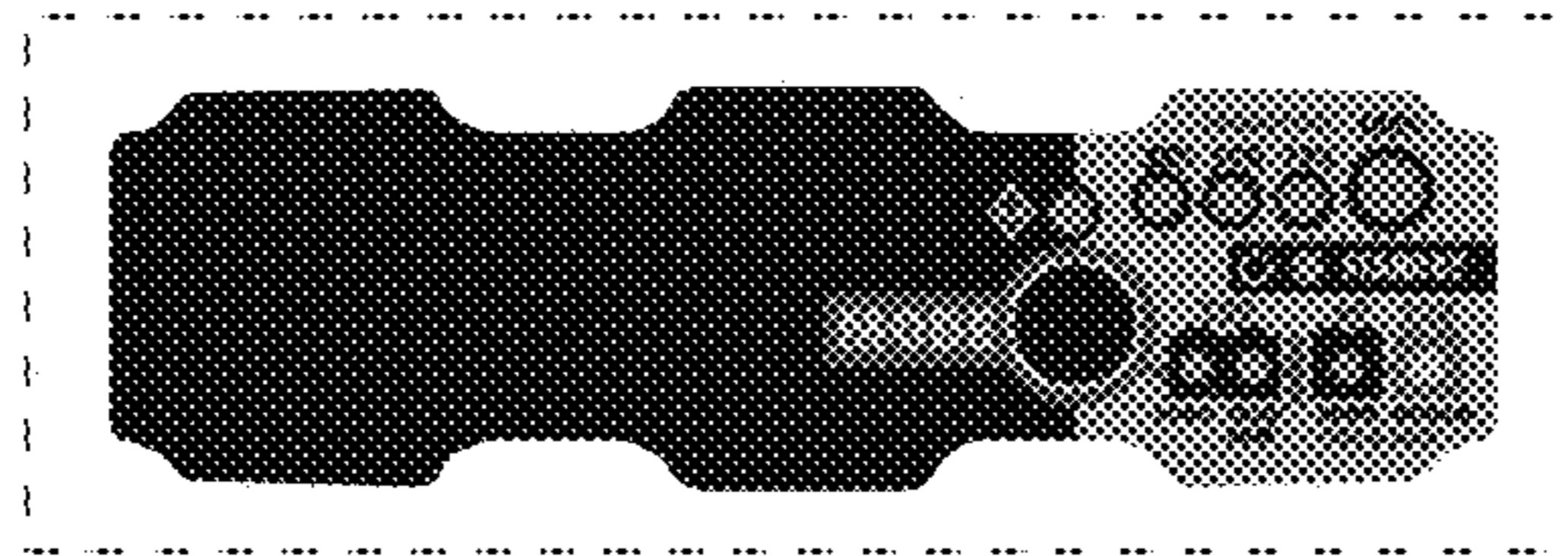

FIG. 7

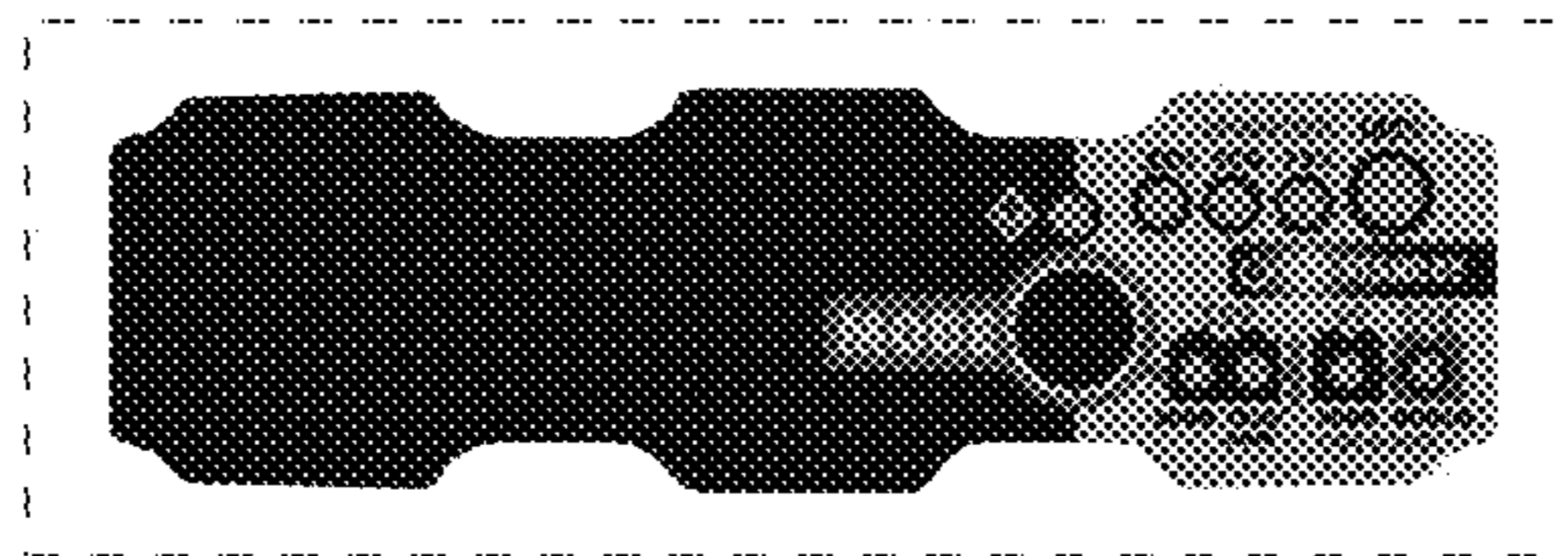

FIG. 8

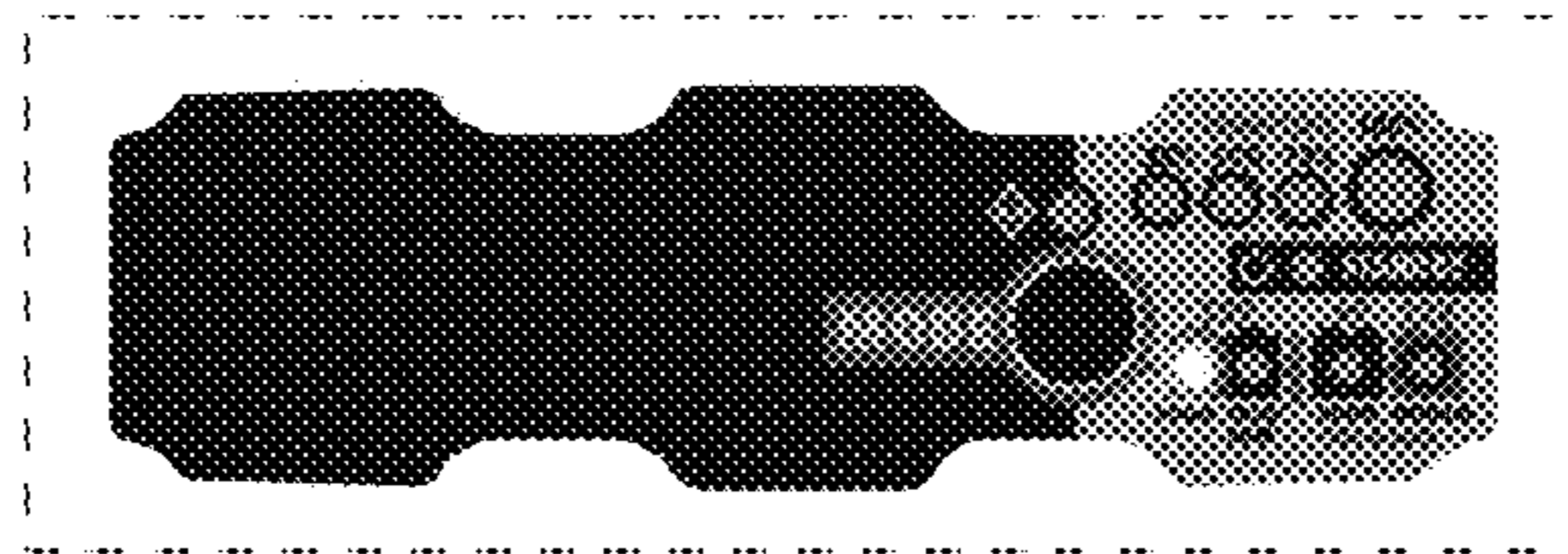

FIG. 9

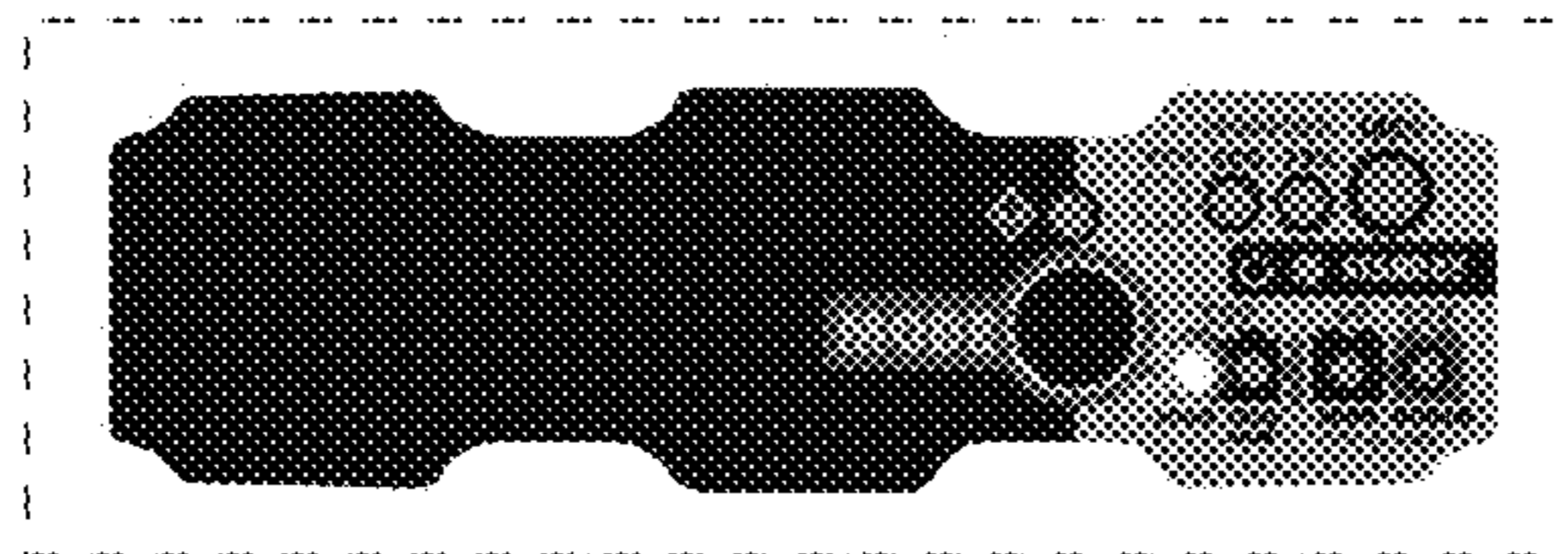

FIG. 10

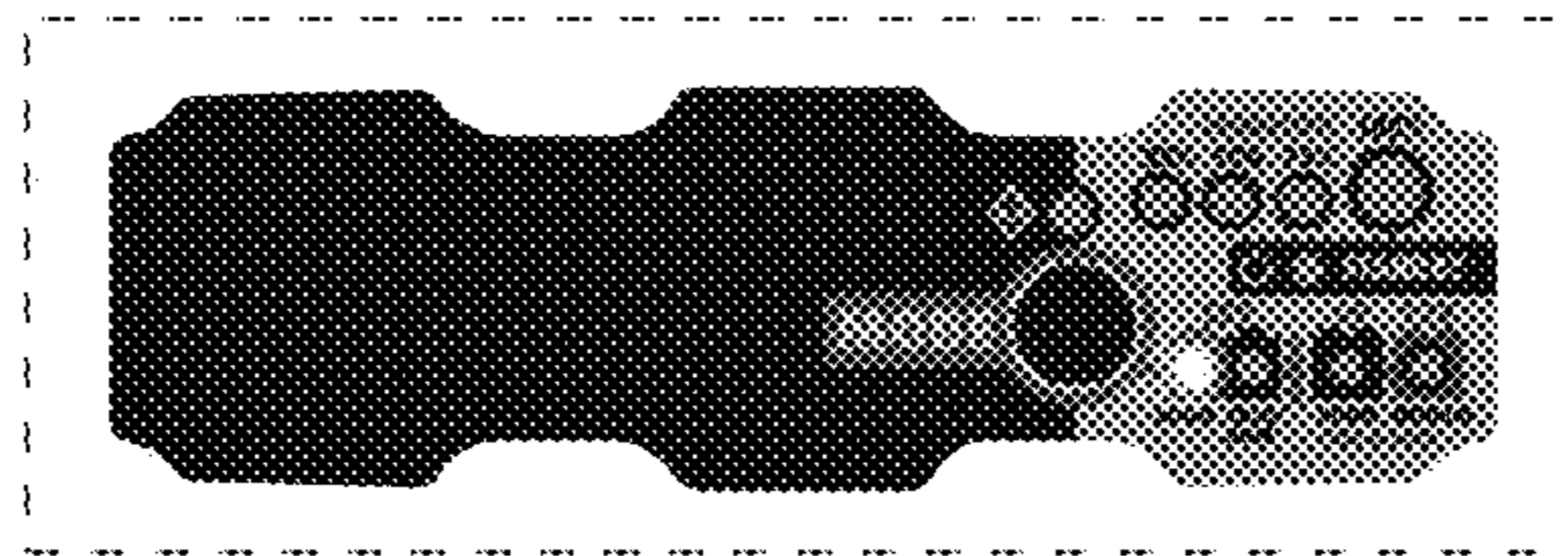

FIG. 11

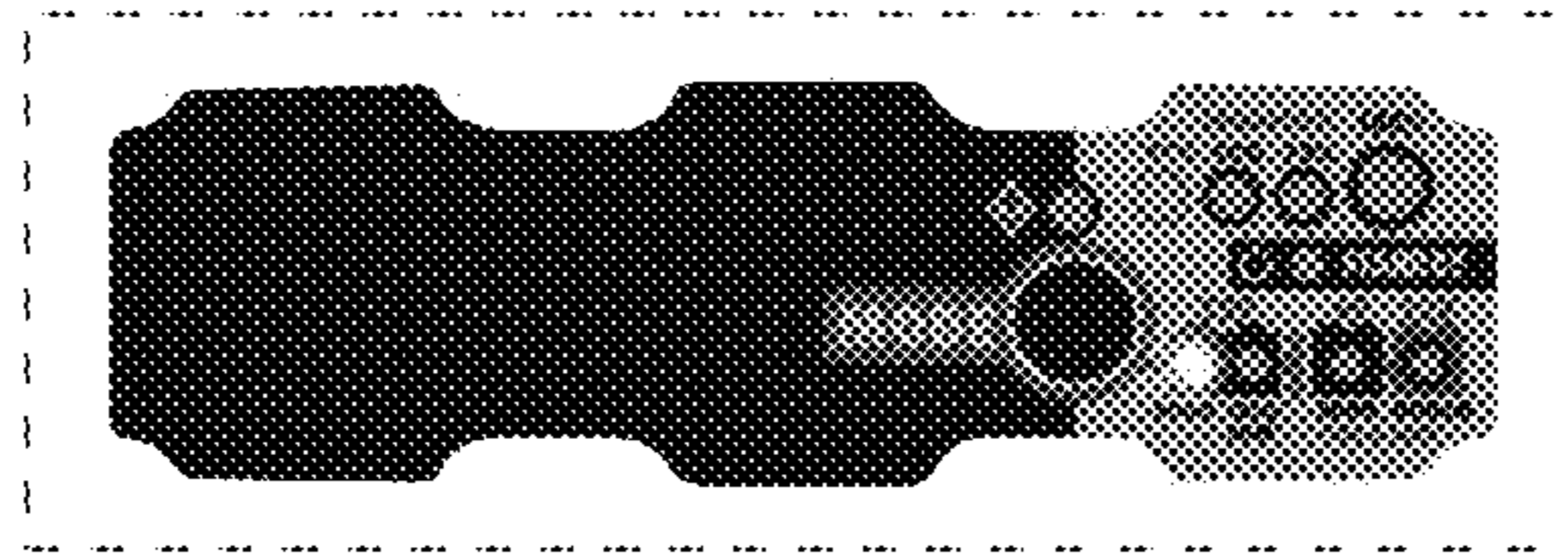

FIG. 12

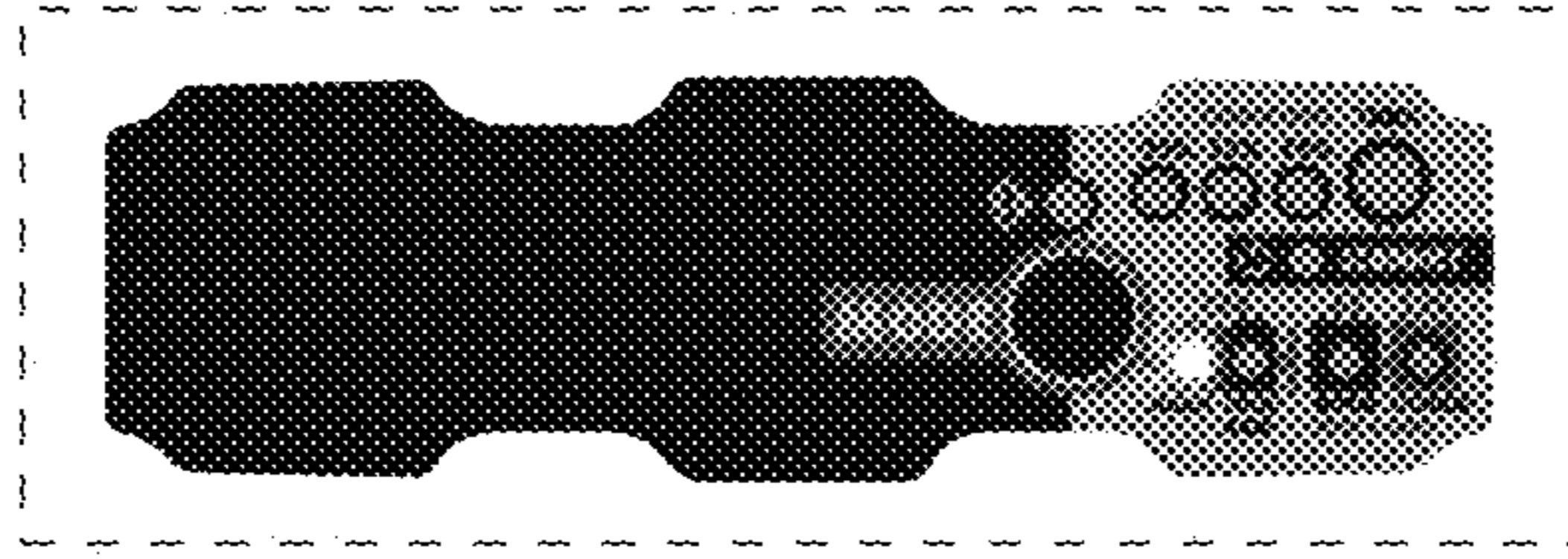

FIG. 13

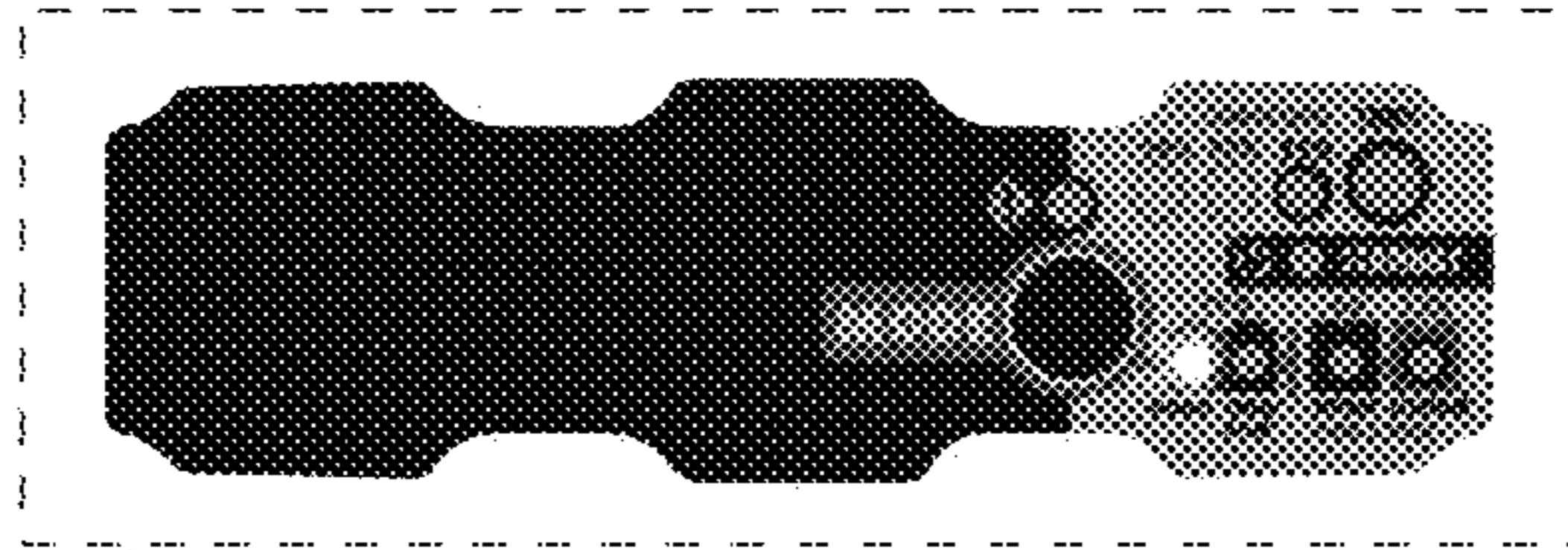

FIG. 14

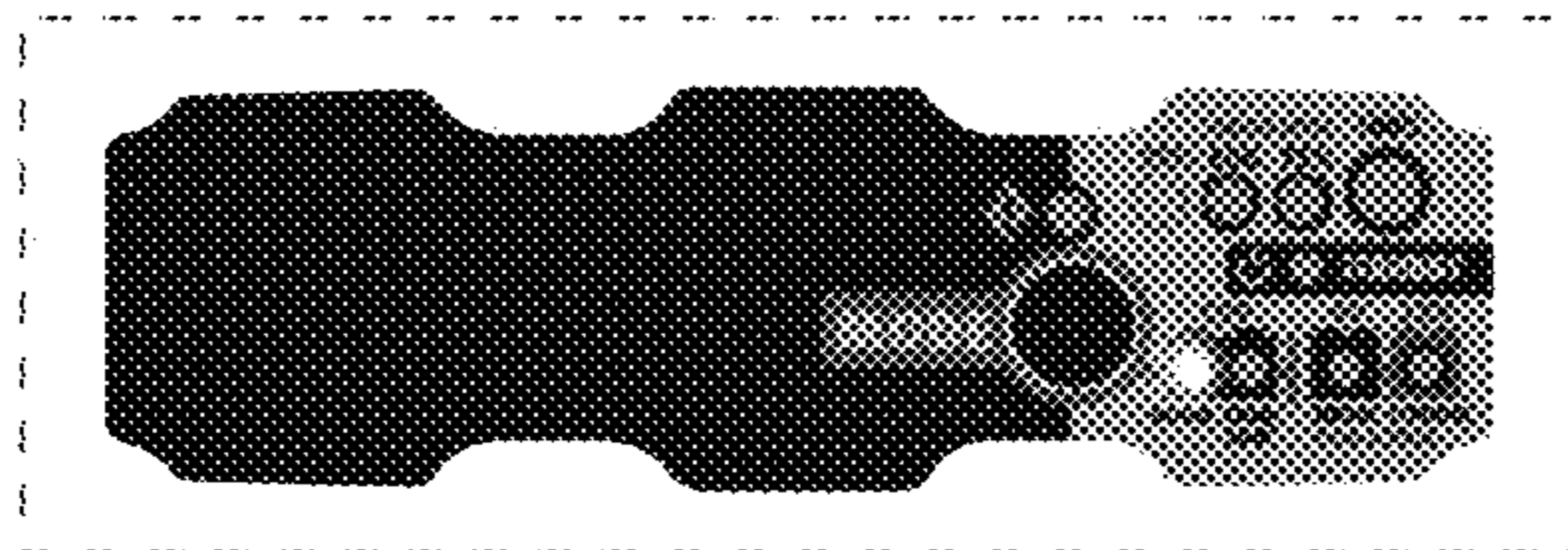

FIG. 15

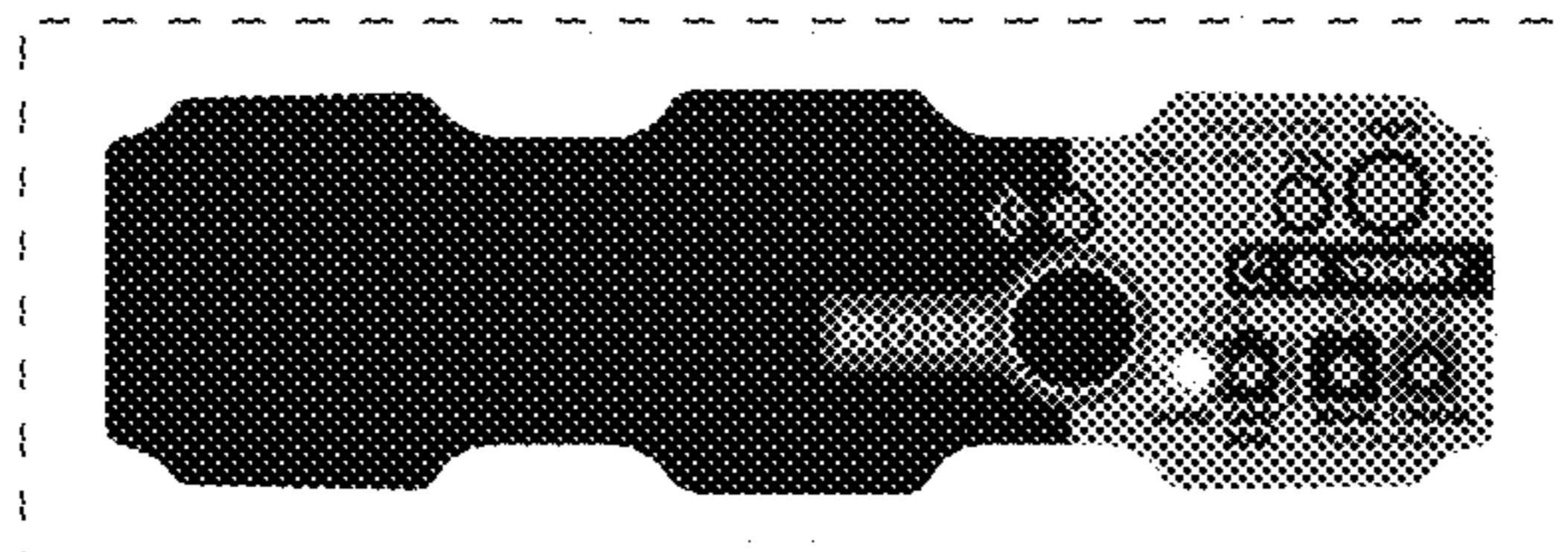

FIG. 16

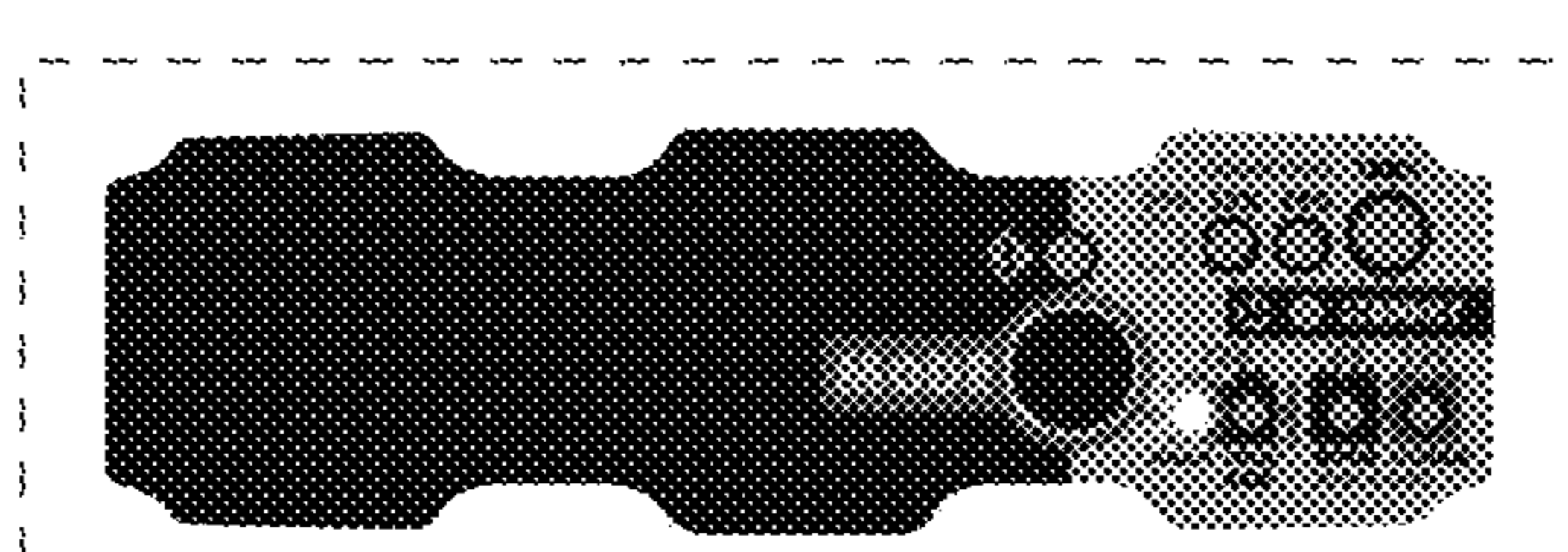

FIG. 17

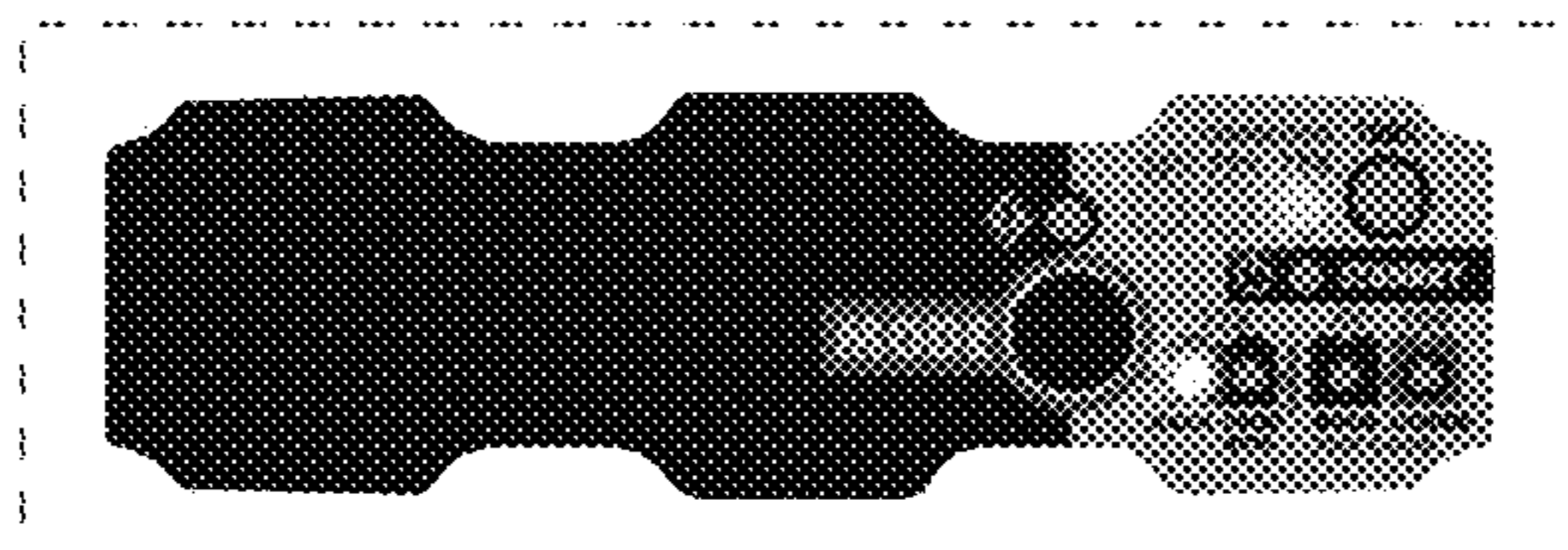

FIG. 18

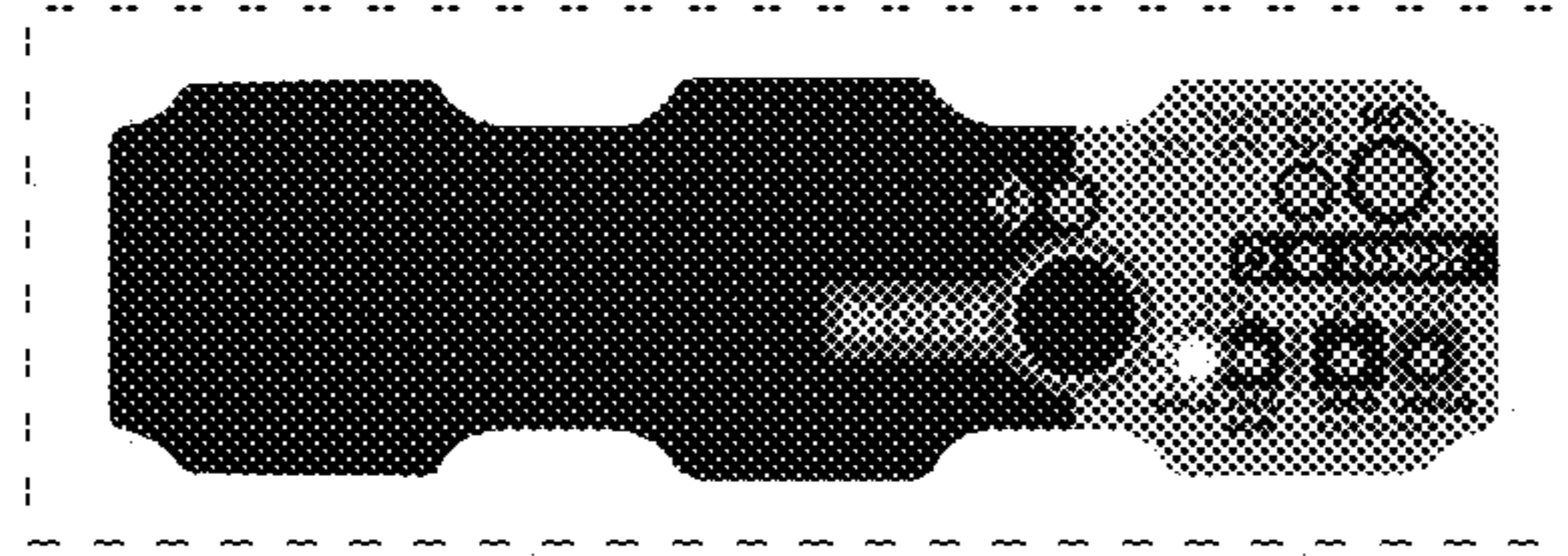

FIG. 19

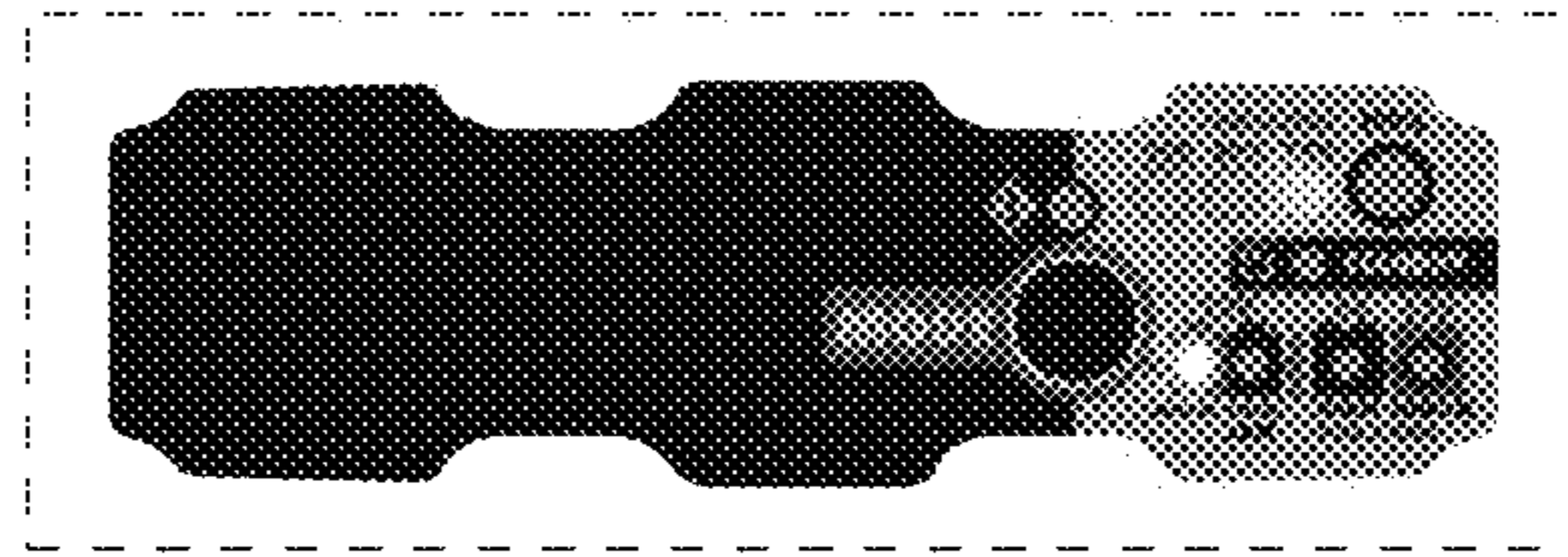

FIG. 20

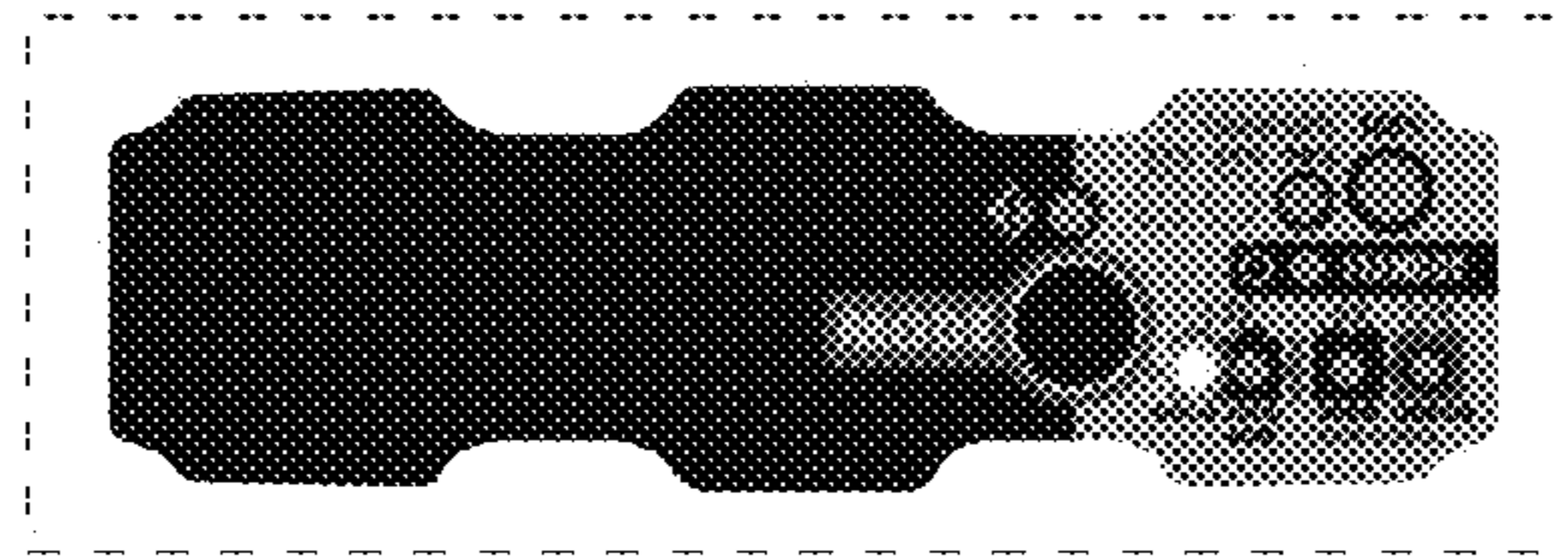

FIG. 21

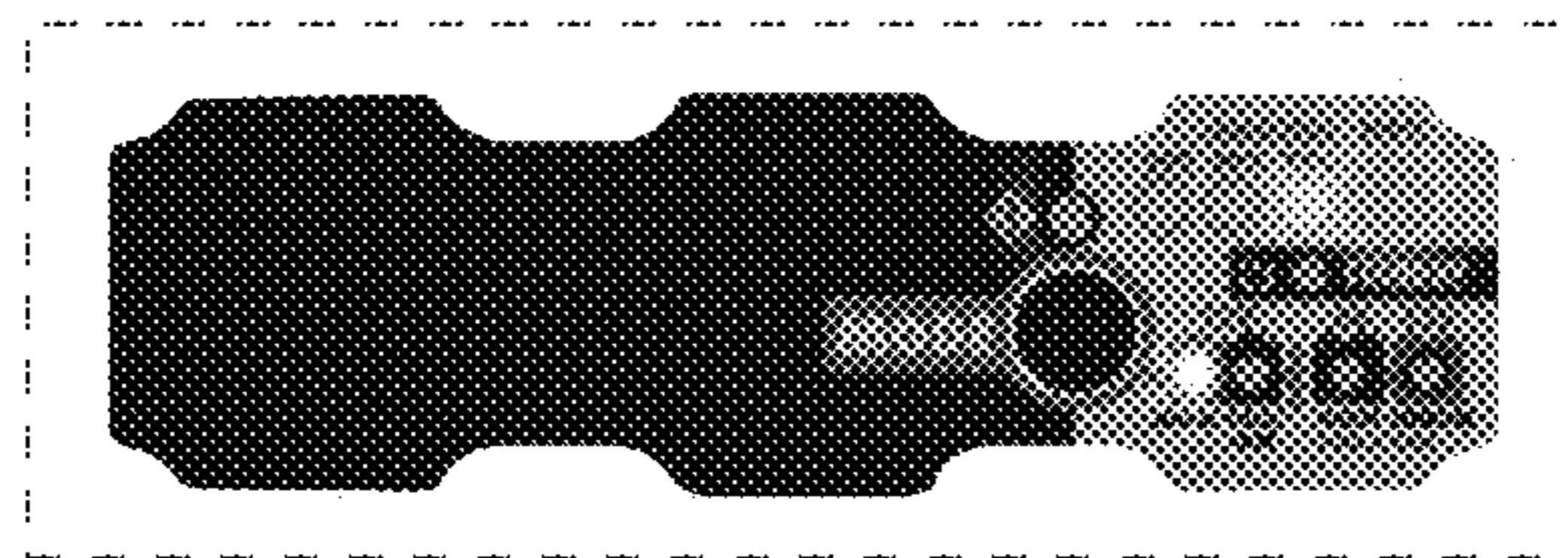

FIG. 22

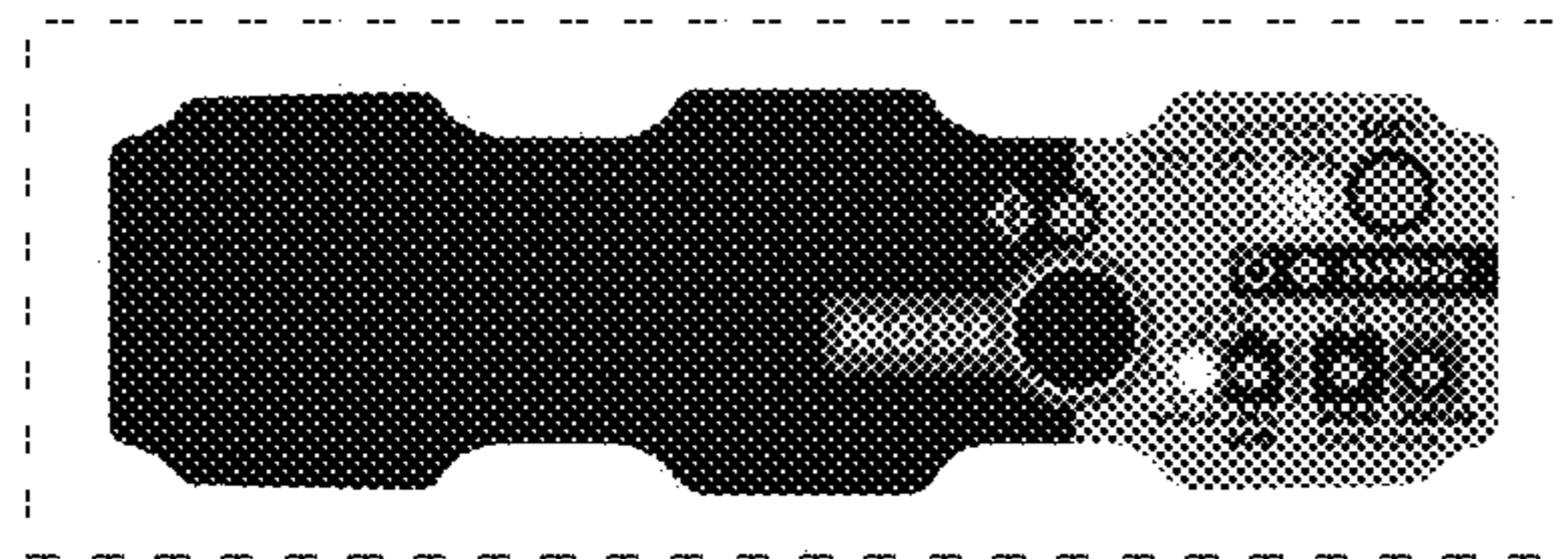

FIG. 23

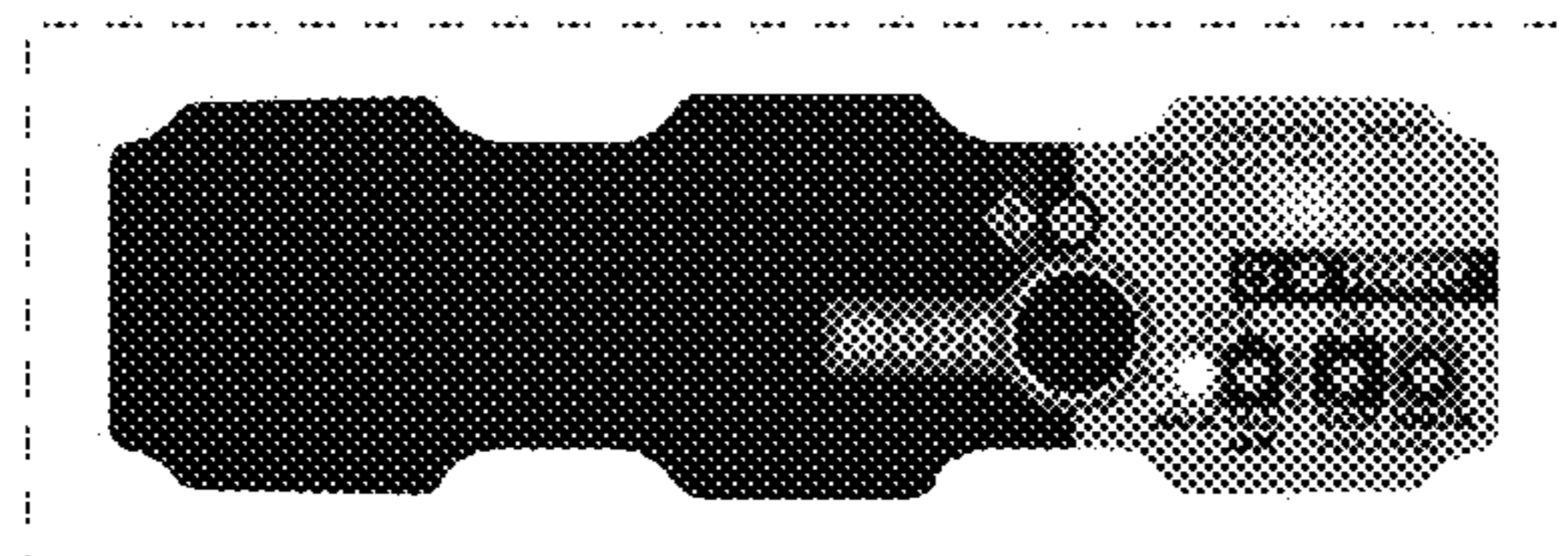

FIG. 24

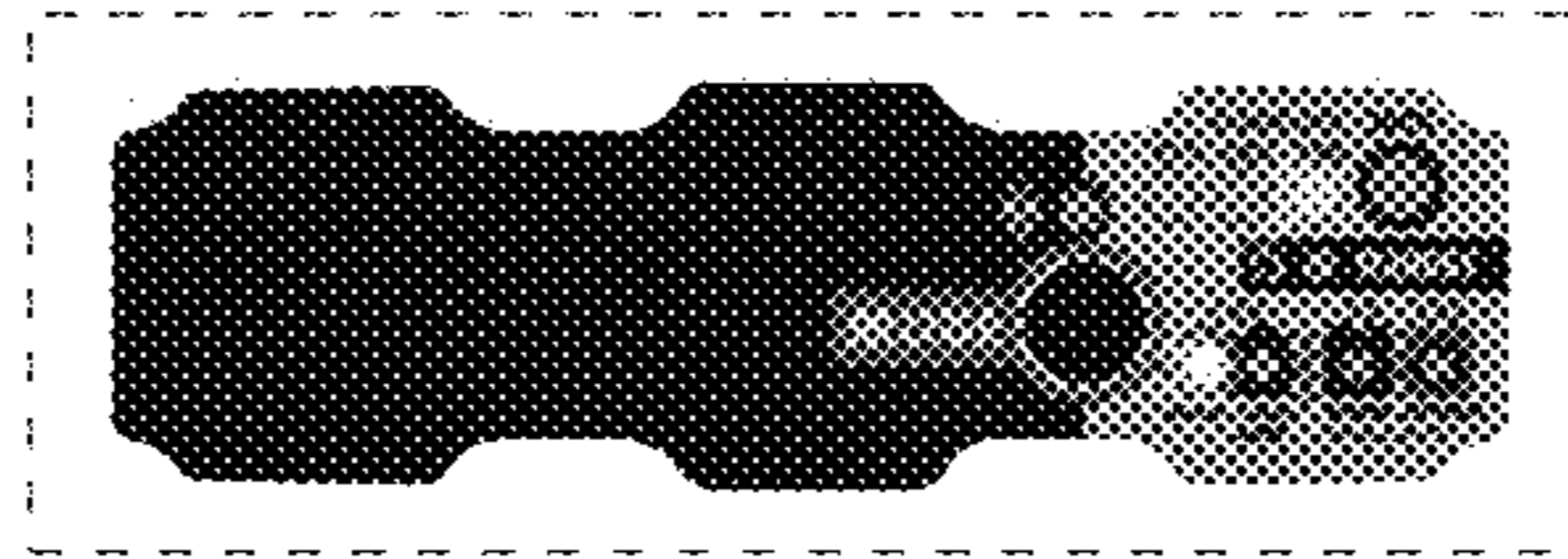

FIG. 25

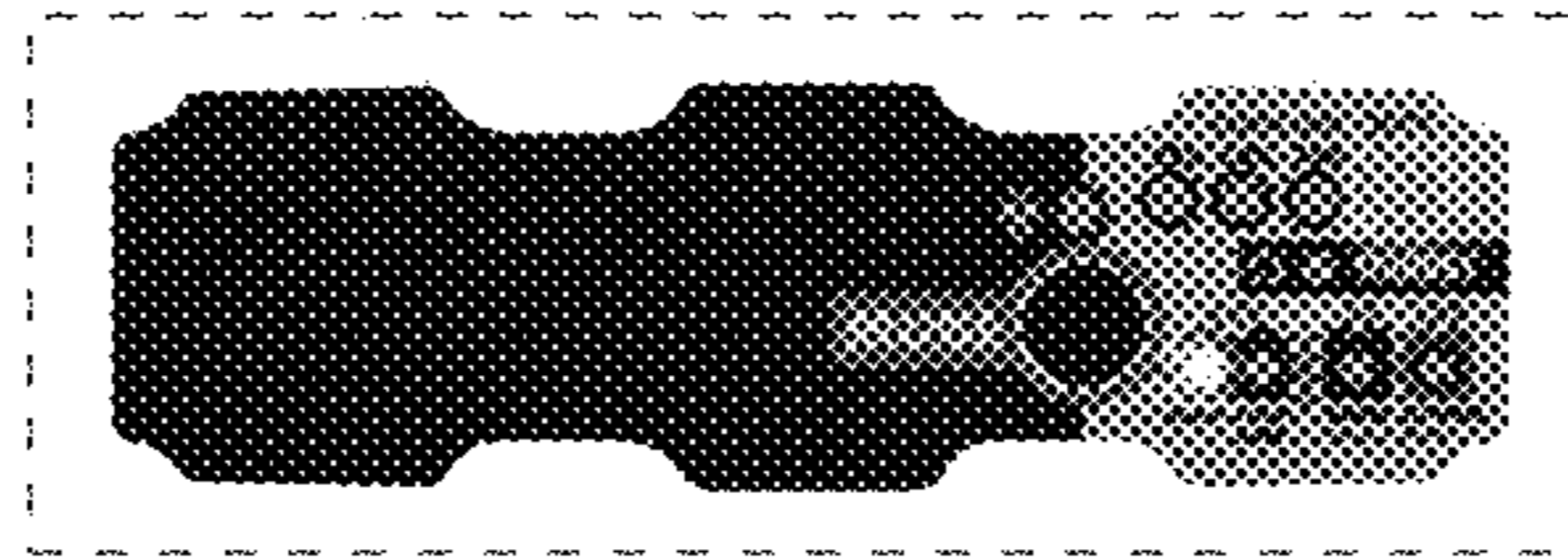

FIG. 26

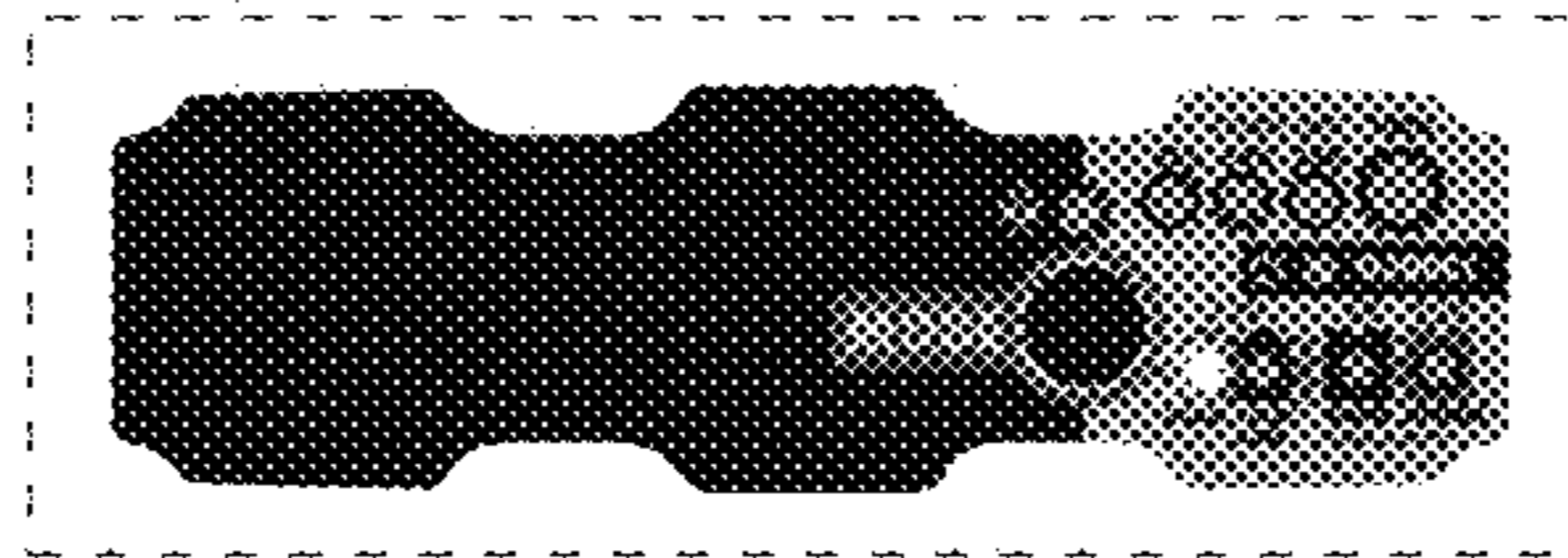

FIG. 27

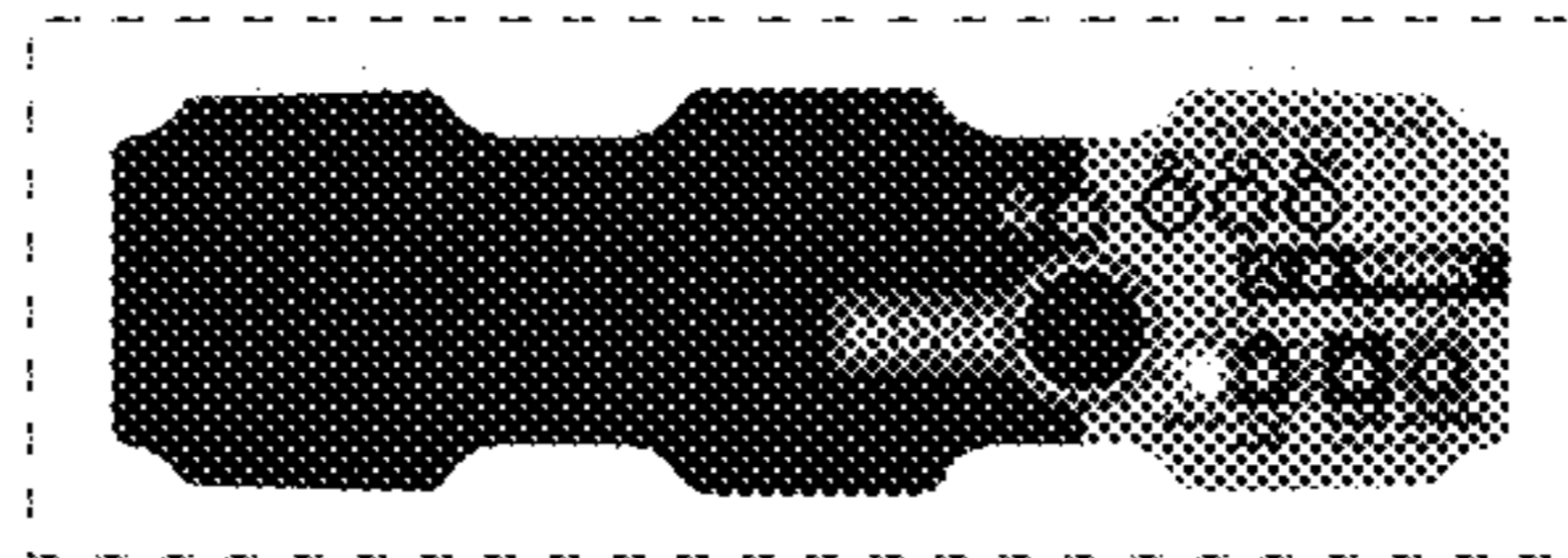

FIG. 28

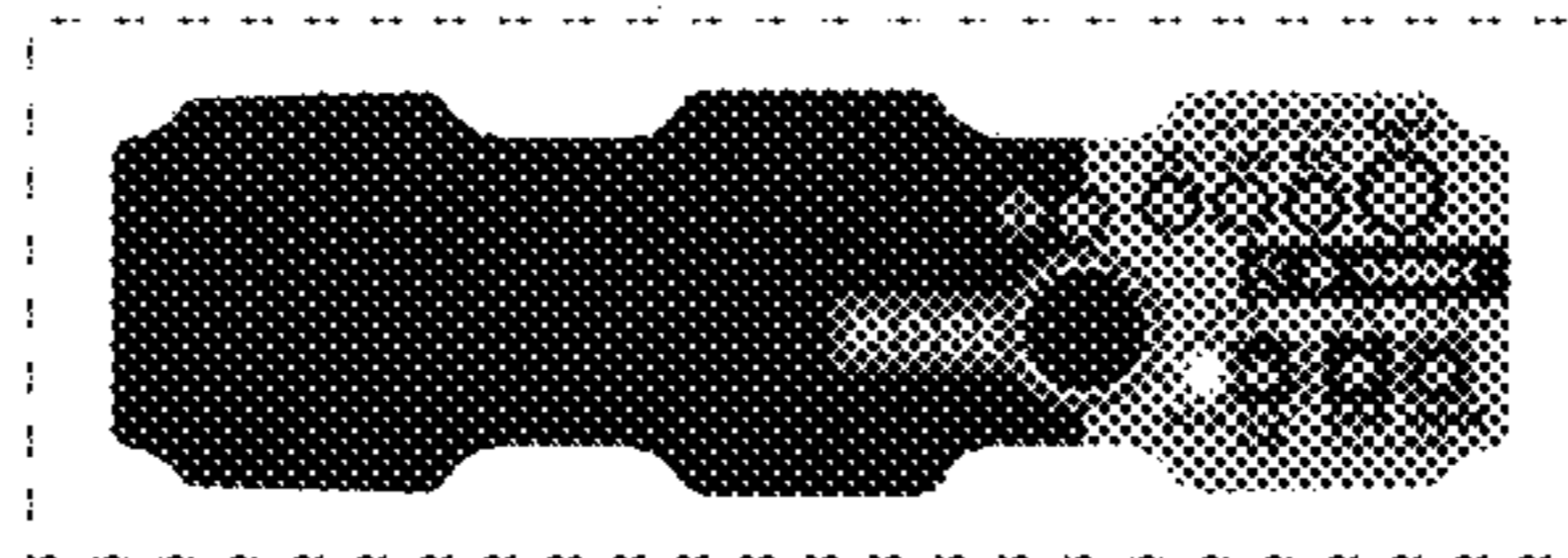

FIG. 29

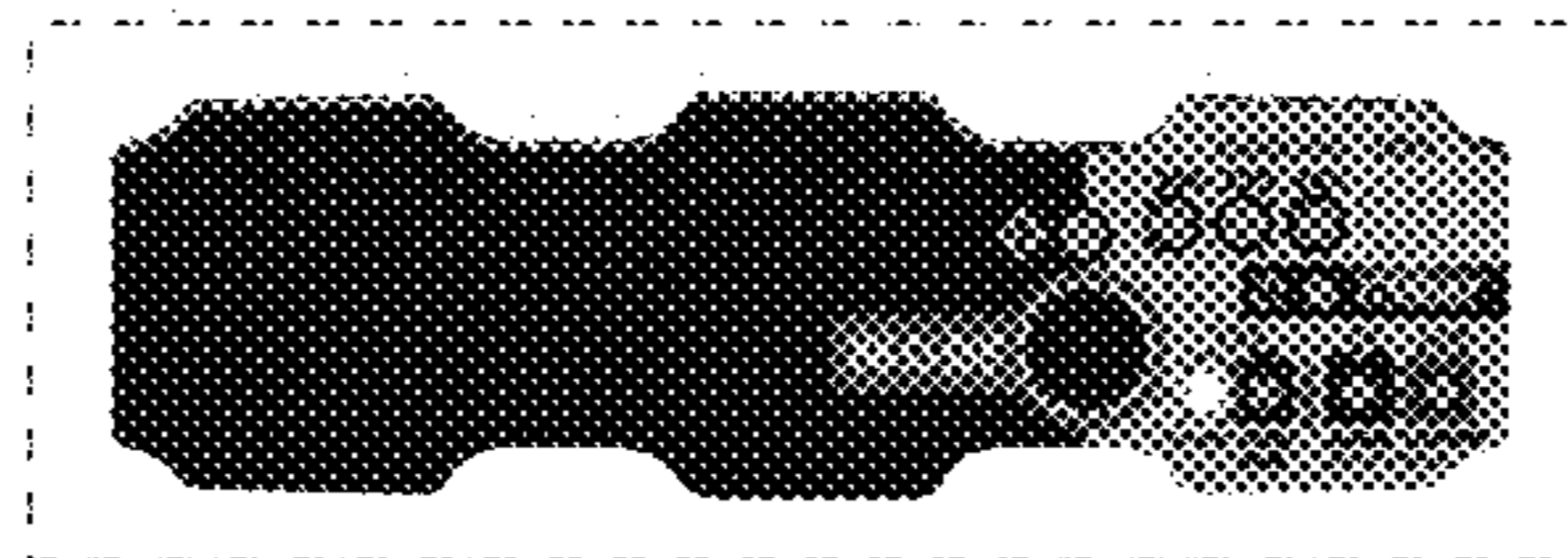

FIG. 30

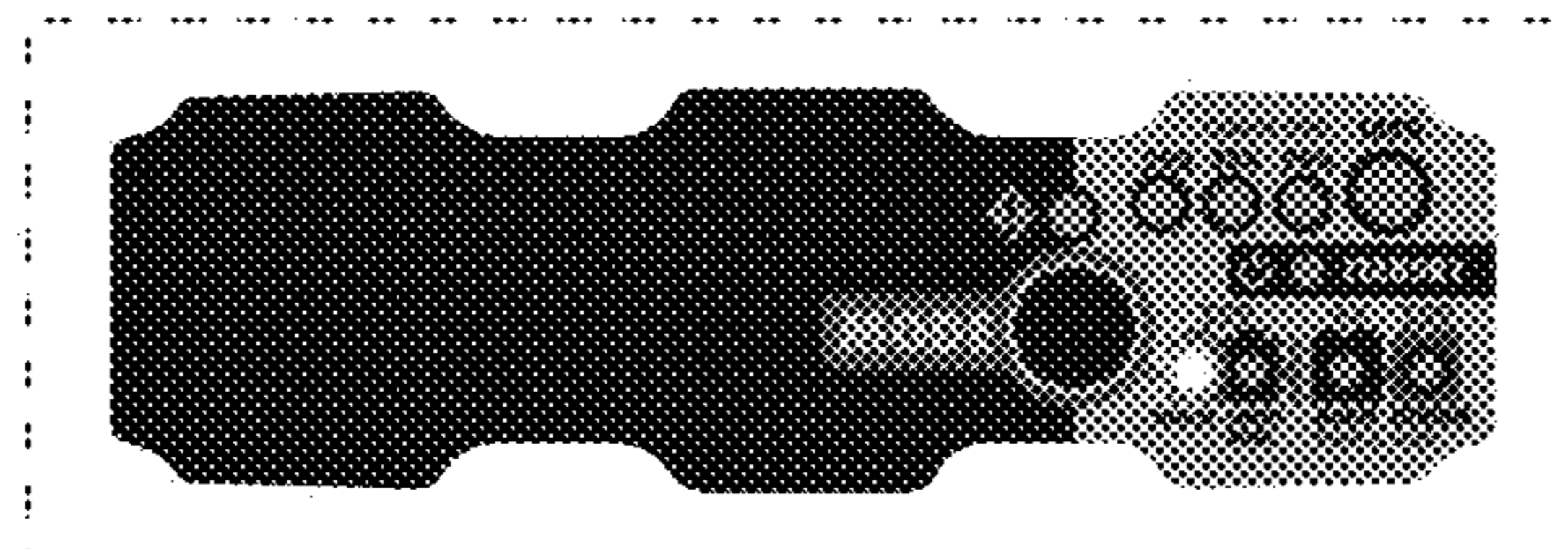

FIG. 31

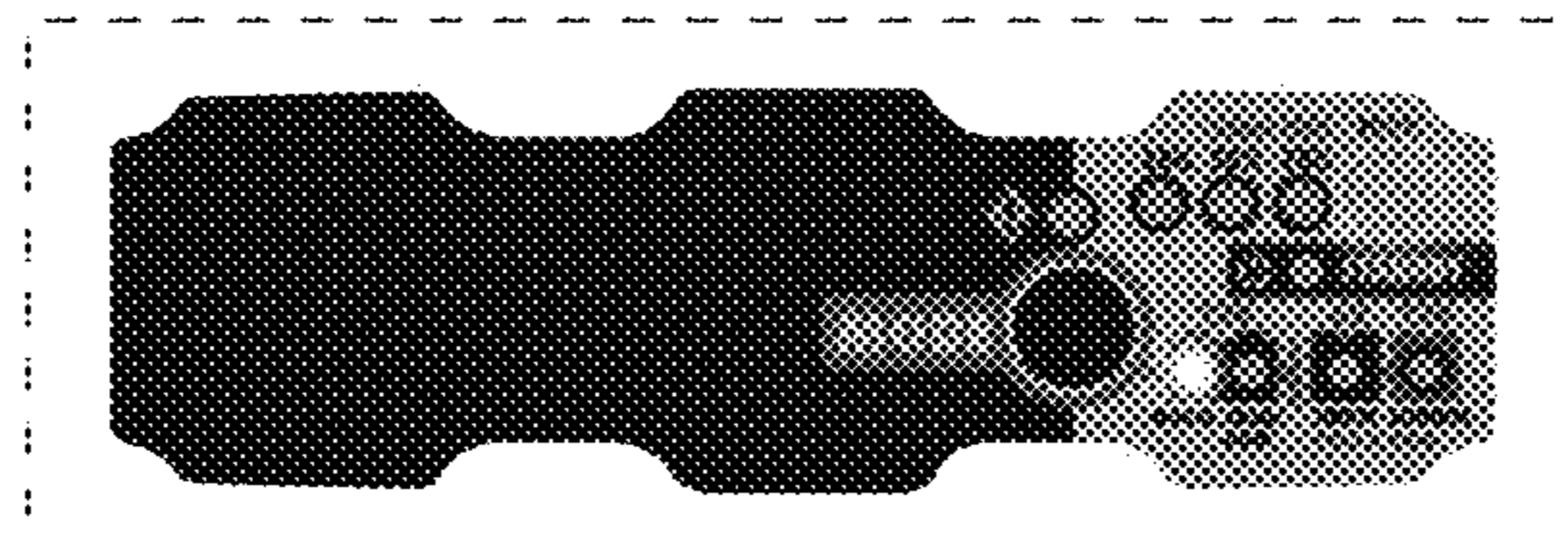

FIG. 32