



US00D769246S

(12) **United States Design Patent** (10) **Patent No.:** **US D769,246 S**
Mielnik et al. (45) **Date of Patent:** **** Oct. 18, 2016**

(54) **DISTRIBUTED CONTROL SYSTEM
MODULE-MOUNTING BASE**

D468,258 S 1/2003 Guo et al.
D488,815 S * 4/2004 Hashimoto D13/147
D525,197 S 7/2006 Tanabe et al.

(71) Applicant: **ABB Technology AG**, Zurich (CH)

(Continued)

(72) Inventors: **David Mielnik**, Painesville, OH (US);
John Piunno, Painesville, OH (US);
Thomas Heilman, Wickliffe, OH (US);
Richard Ogorek, Sagamore hills, OH
(US); **Mike J. Maczuzak**, Bratenahl,
OH (US); **Krzysztof Miedza**, Bay
Village, OH (US); **Dan Morgan**,
Cleveland, OH (US)

OTHER PUBLICATIONS

U.S. Appl. No. 29/470,553, filed Oct. 22, 2013, Mielnik et al.

Primary Examiner — Austin Murphy
(74) *Attorney, Agent, or Firm* — Taft Stettinius &
Hollister LLP

(73) Assignee: **ABB Schweiz AG**, Baden (CH)

(57) **CLAIM**

The ornamental design of a distributed control system
module-mounting base, substantially as shown and
described.

(**) Term: **14 Years**

DESCRIPTION

(21) Appl. No.: **29/513,217**

(22) Filed: **Dec. 29, 2014**

(51) **LOC (10) Cl.** **14-02**

(52) **U.S. Cl.**
USPC **D14/433**

(58) **Field of Classification Search**
USPC D14/356, 432-434, 453, 454, 511,
D14/203.8, 209.1, 238.1, 240, 125;
439/638, 928, 105, 502; 710/303, 304;
361/679.41, 679.55, 679.56; D13/110,
D13/133, 146, 123, 162
CPC . H04L 12/2832; H04L 12/2838; G06F 3/00;
G06F 5/00; G06F 13/14
See application file for complete search history.

FIG. 1 is a front and left side perspective view of a
distributed control system module-mounting base in accordance with the present invention;
FIG. 2 is a front and right side perspective view of the
distributed control system module-mounting base in FIG. 1;
FIG. 3 is a front elevation view thereof;
FIG. 4 is a top plan view thereof;
FIG. 5 is a right side elevation view thereof;
FIG. 6 is a left side elevation view thereof;
FIG. 7 is a rear elevation view thereof;
FIG. 8 is a bottom plan view thereof;
FIG. 9 is a front and left side perspective view of another
embodiment of a distributed control system module-mount-
ing base in accordance with the present invention;
FIG. 10 is a front and right side perspective view of the
distributed control system module-mounting base in FIG. 9;
FIG. 11 is a front elevation view thereof;
FIG. 12 is a top plan view thereof;
FIG. 13 is a right side elevation view thereof;
FIG. 14 is a left side elevation view thereof;
FIG. 15 is a rear elevation view thereof; and,
FIG. 16 is a bottom plan view thereof.

(56) **References Cited**

U.S. PATENT DOCUMENTS

D288,685 S 3/1987 Arai et al.
D374,663 S * 10/1996 Rodrigues D14/433
D375,084 S 10/1996 Hamada
D413,572 S 9/1999 Byrd et al.
5,984,734 A 11/1999 Piper et al.
6,185,095 B1 2/2001 Helot et al.
6,257,936 B1 7/2001 Strandberg
6,456,495 B1 9/2002 Wieloch et al.

1 Claim, 6 Drawing Sheets

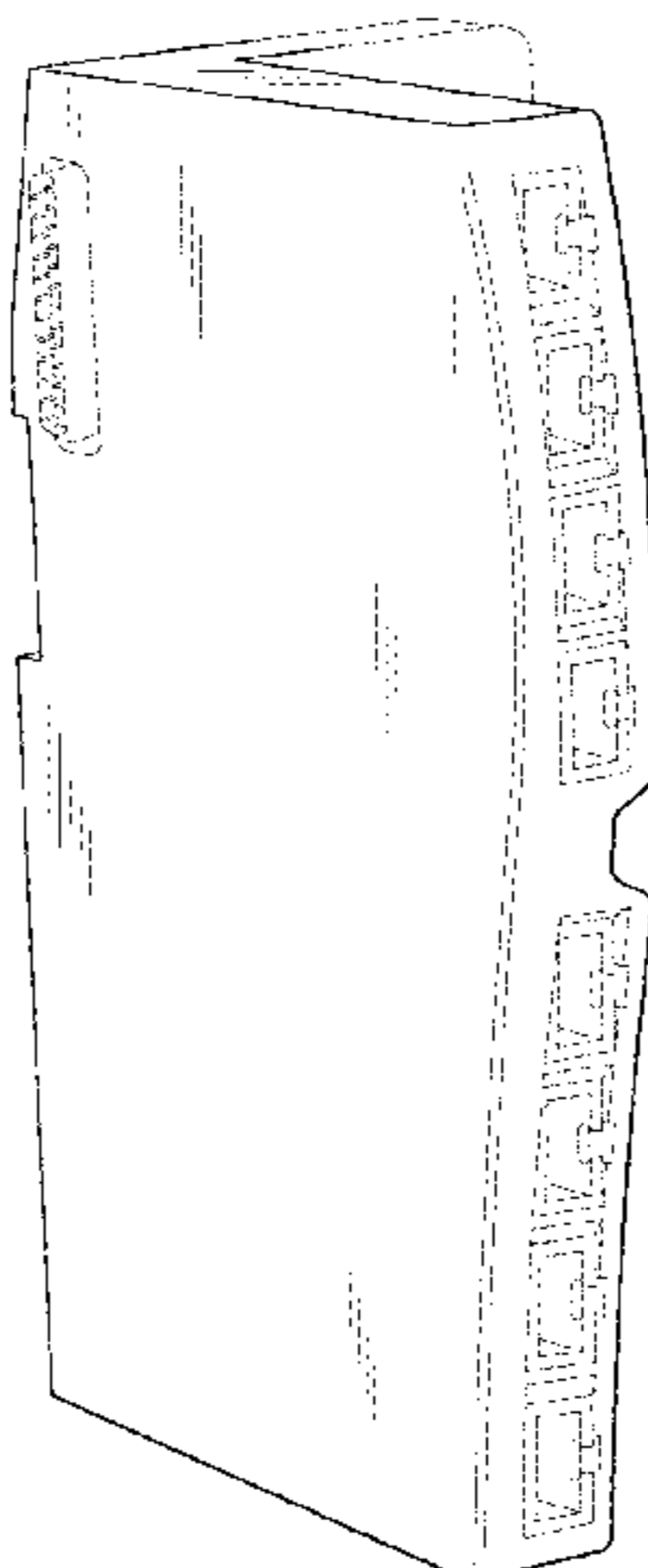

(56)

References Cited

U.S. PATENT DOCUMENTS

D532,378 S 11/2006 Kesler
D539,852 S * 4/2007 Hussaini D14/433
D605,119 S 12/2009 Pape et al.
D605,120 S 12/2009 Pape et al.
D609,195 S 2/2010 Yamashita et al.
D669,855 S 10/2012 Correll et al.

D688,248 S * 8/2013 Tsuda D14/433
D691,141 S * 10/2013 Cruz D14/307
D702,242 S * 4/2014 Tsuda D14/433
D717,803 S * 11/2014 Takano D14/433
D726,182 S * 4/2015 Durham D14/385
D740,291 S * 10/2015 Turksu D14/433
D742,881 S * 11/2015 Takano D14/432
D742,882 S * 11/2015 Takano D14/432
D744,487 S * 12/2015 Takano D14/432

* cited by examiner



FIG. 1

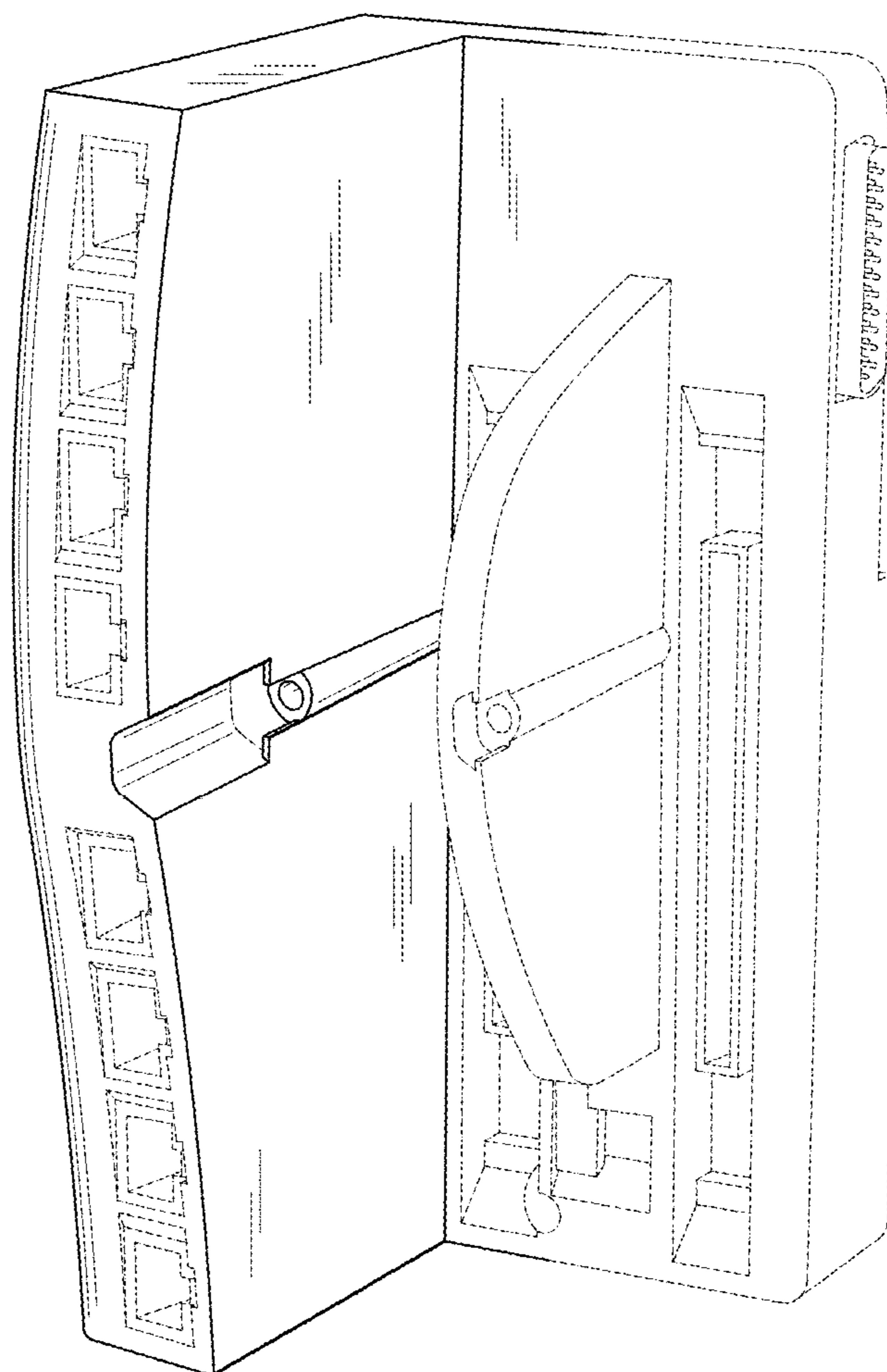

FIG. 2

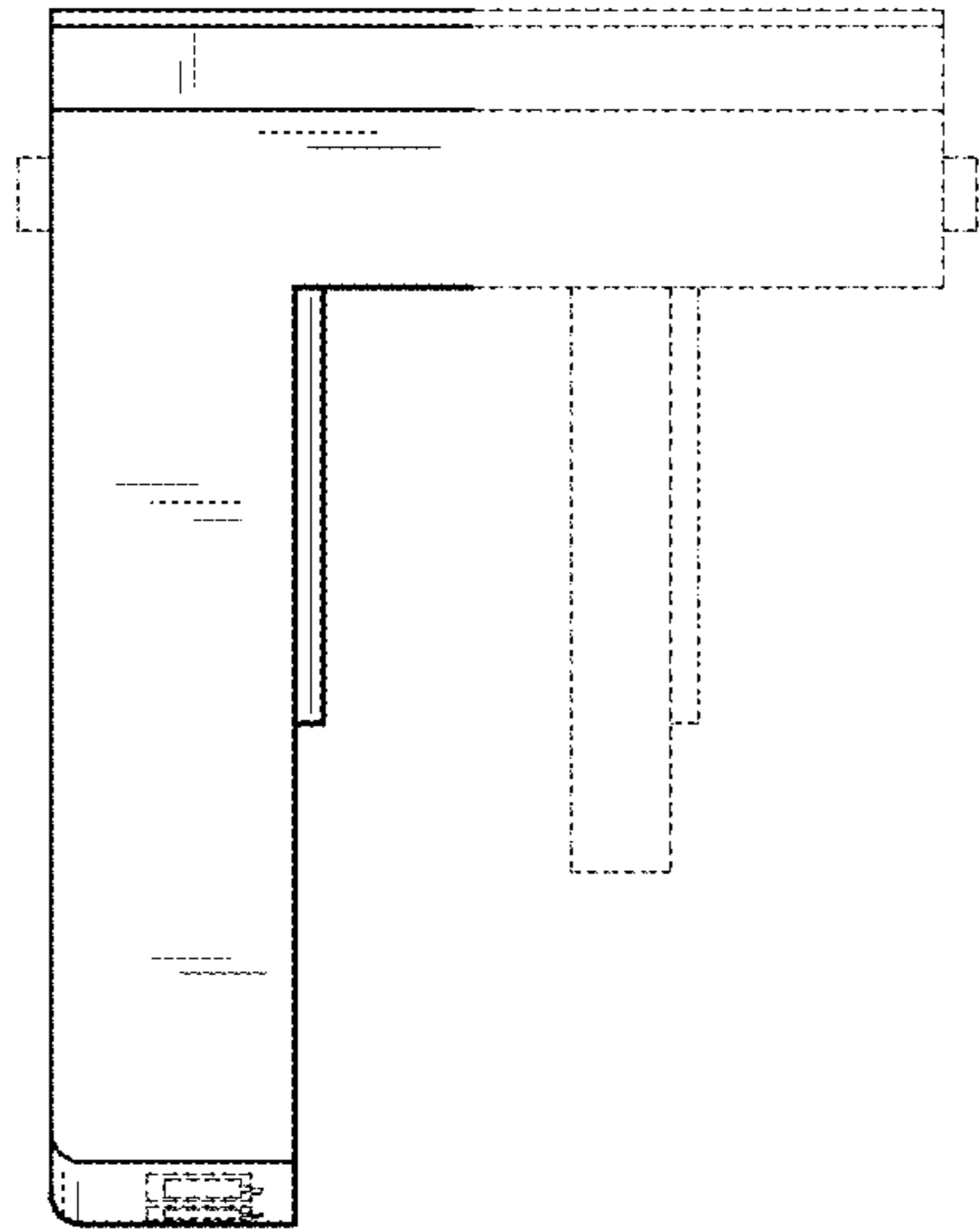

FIG. 4

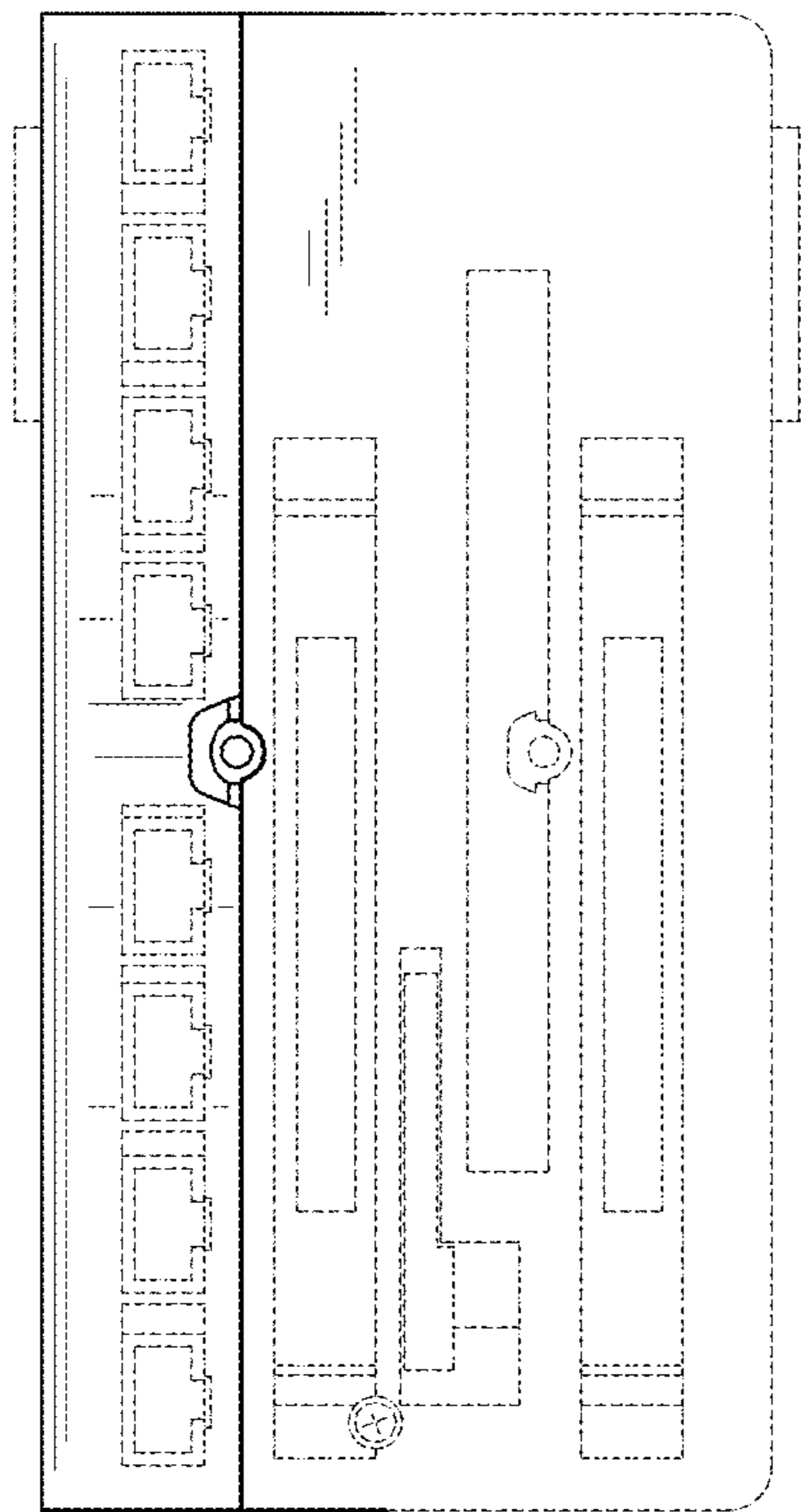

FIG. 3

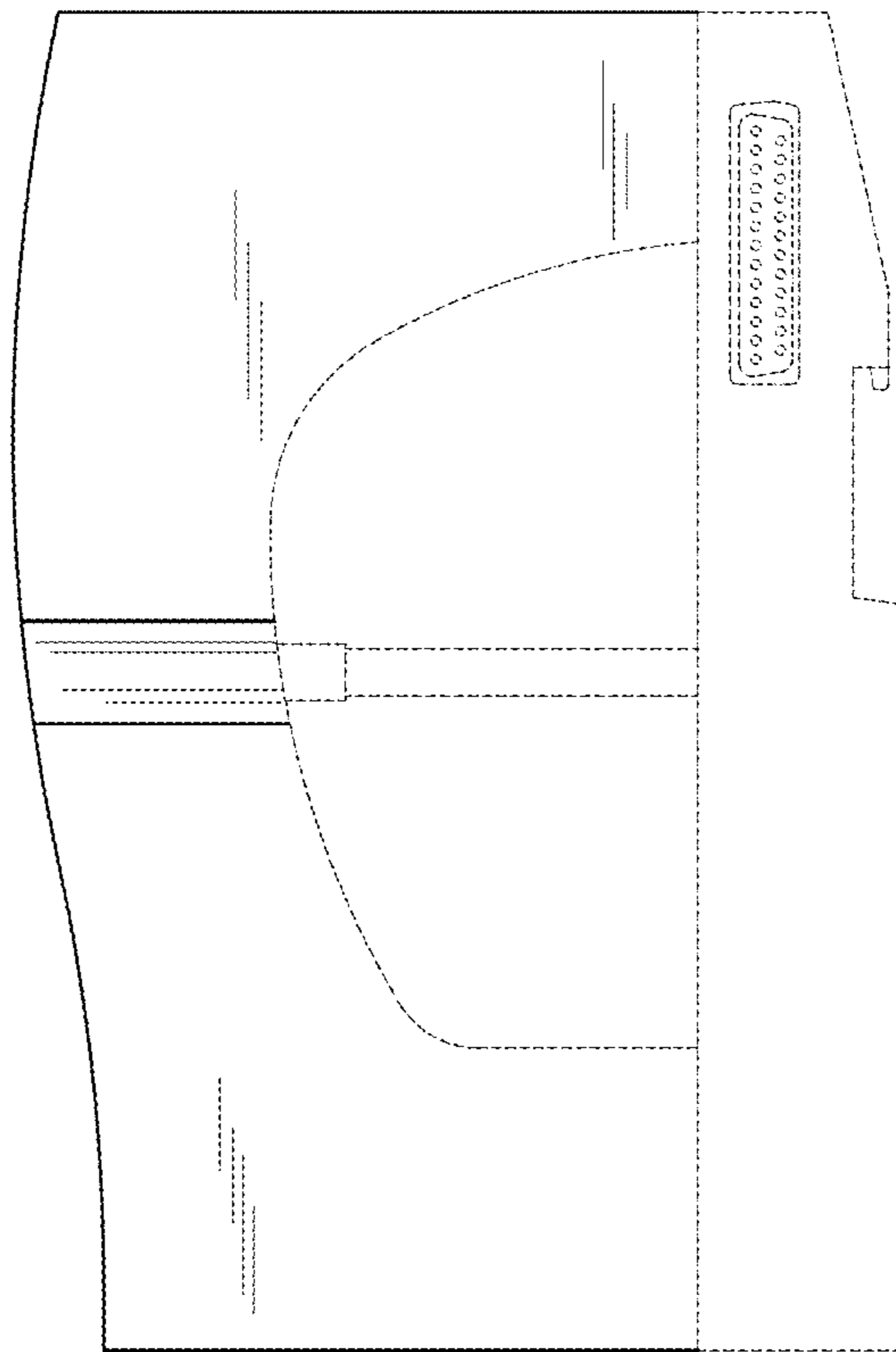

FIG. 5

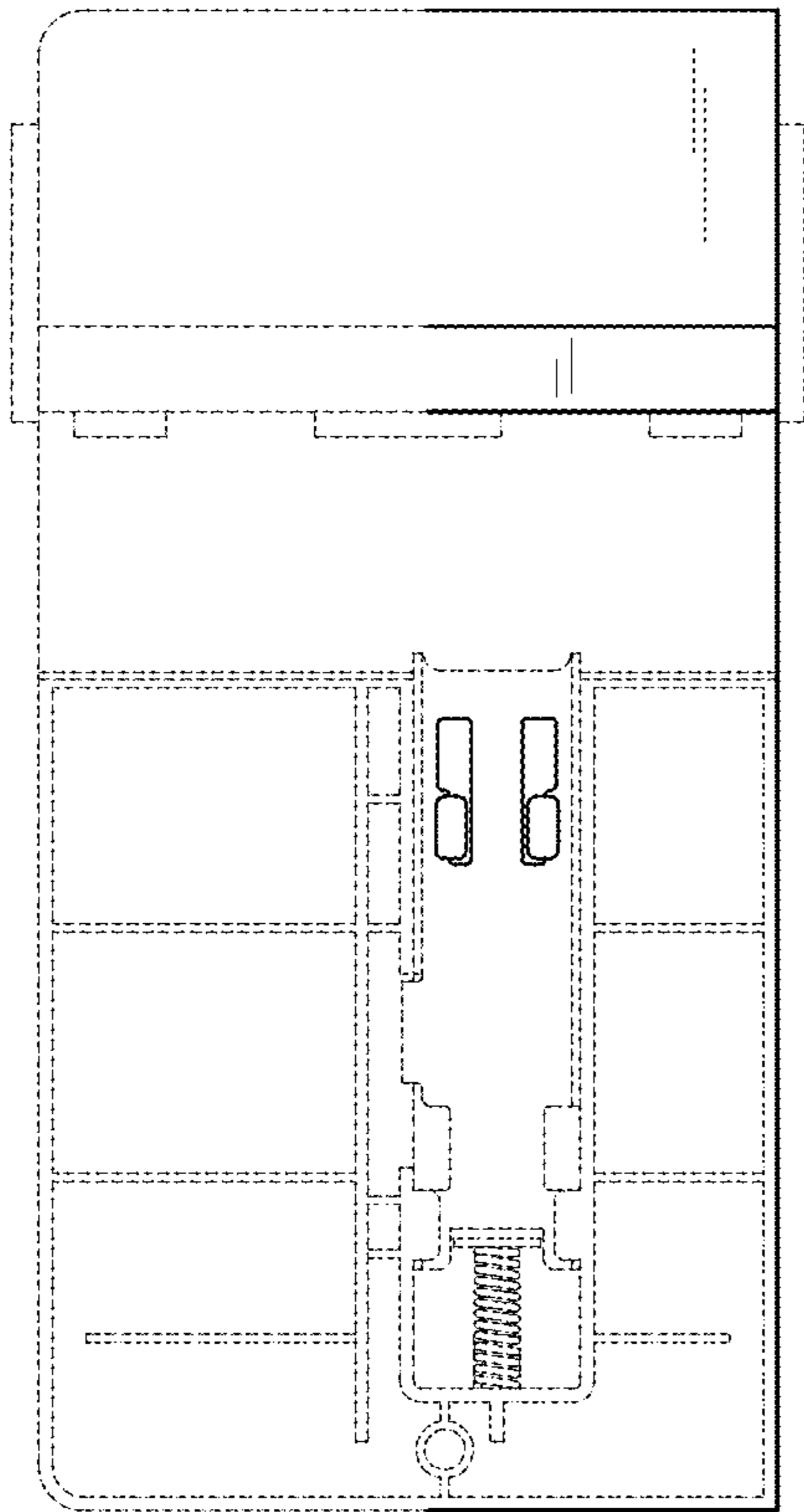

FIG. 7

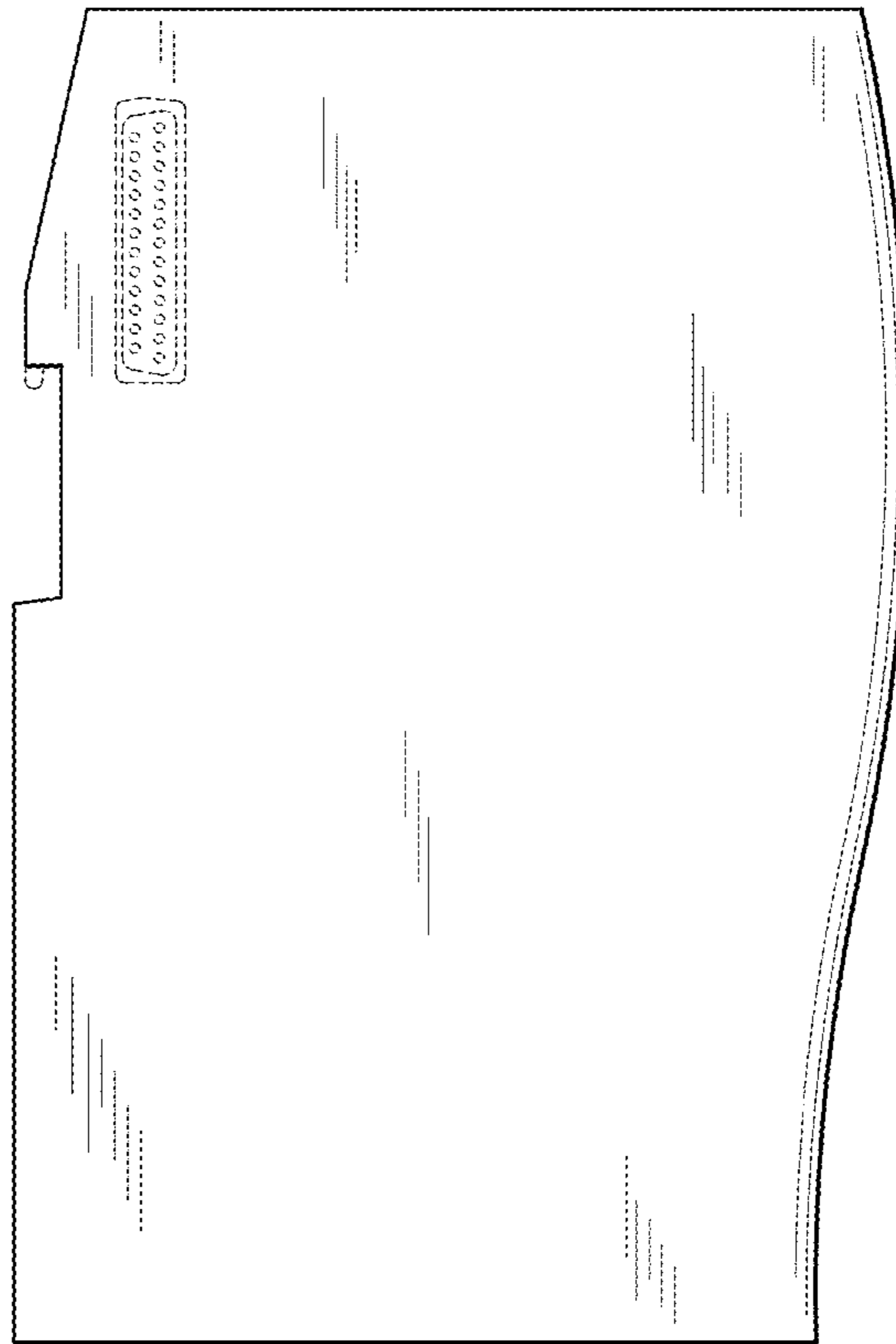

FIG. 6

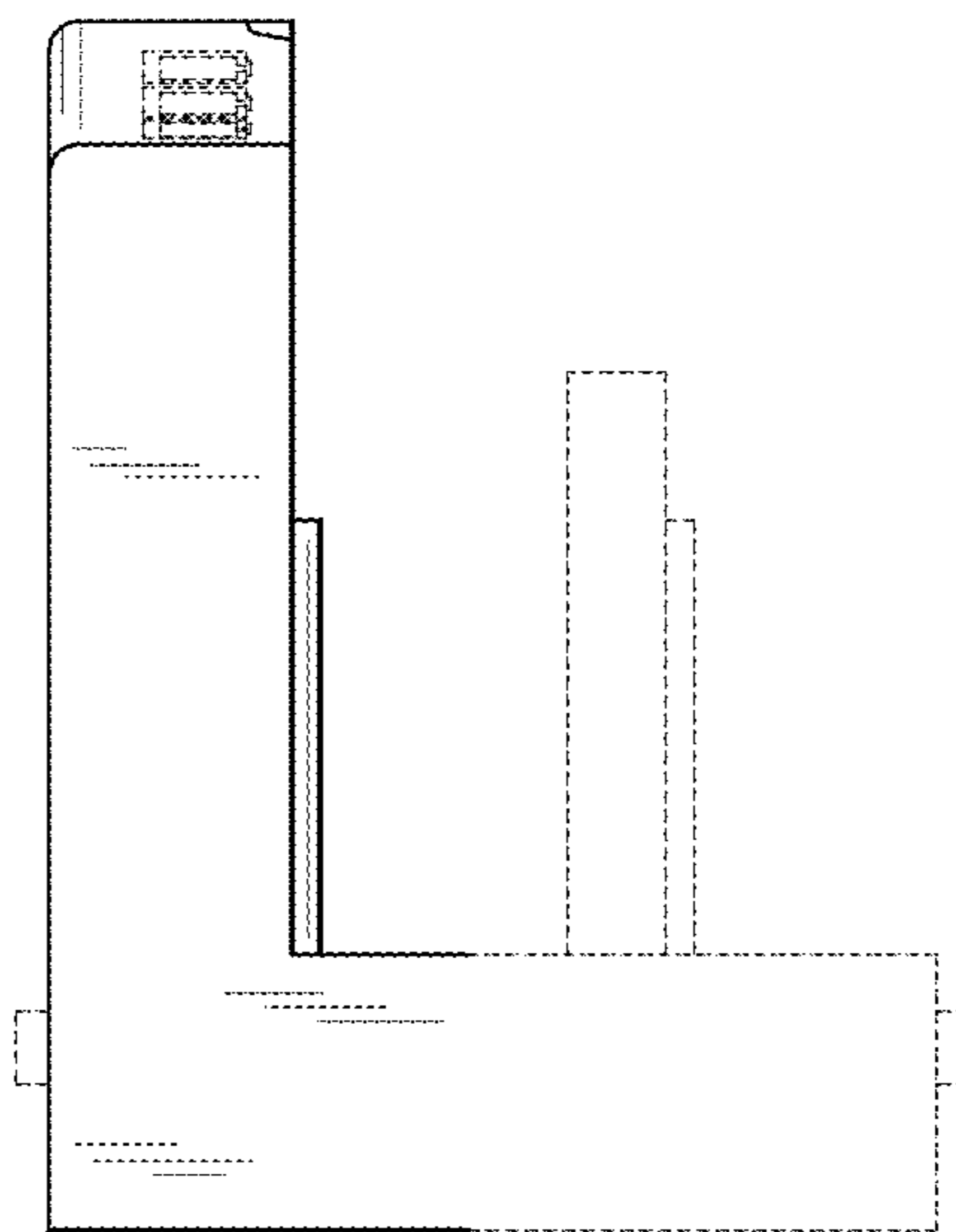

FIG. 8

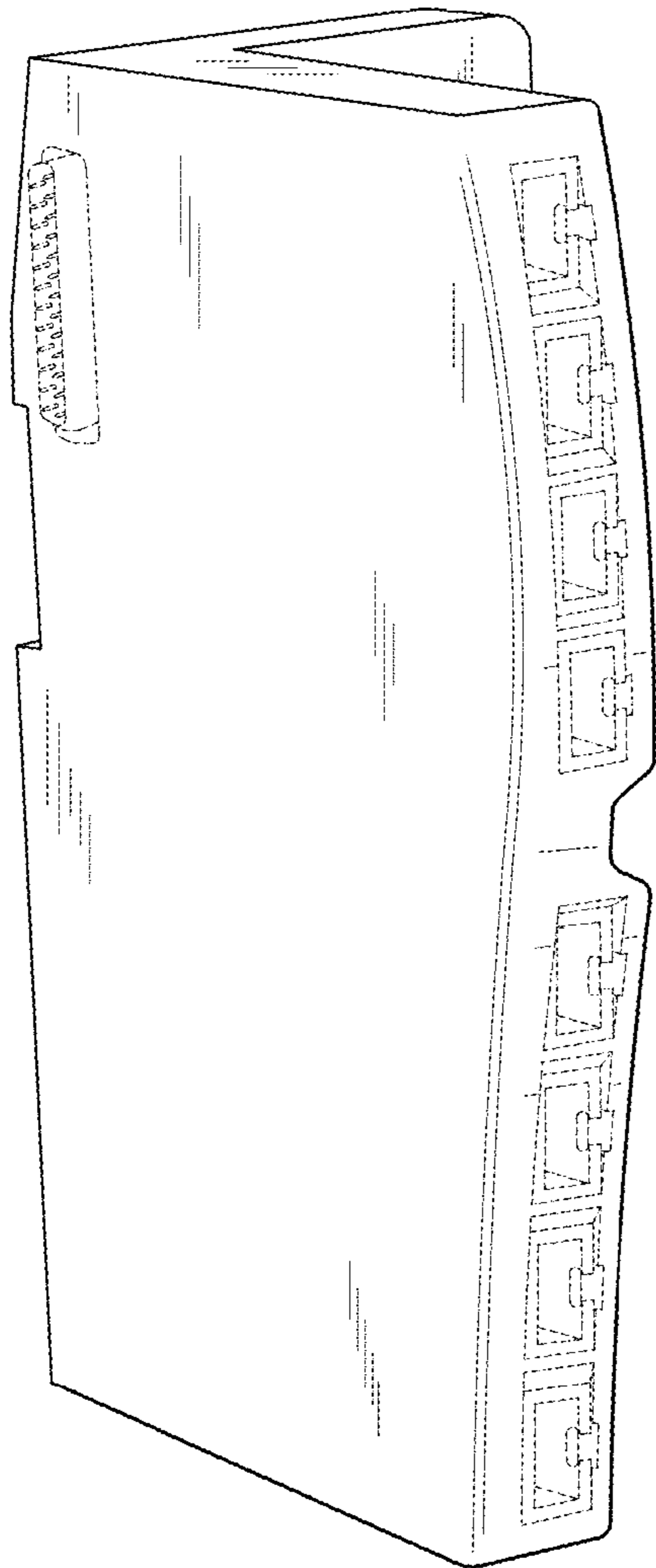
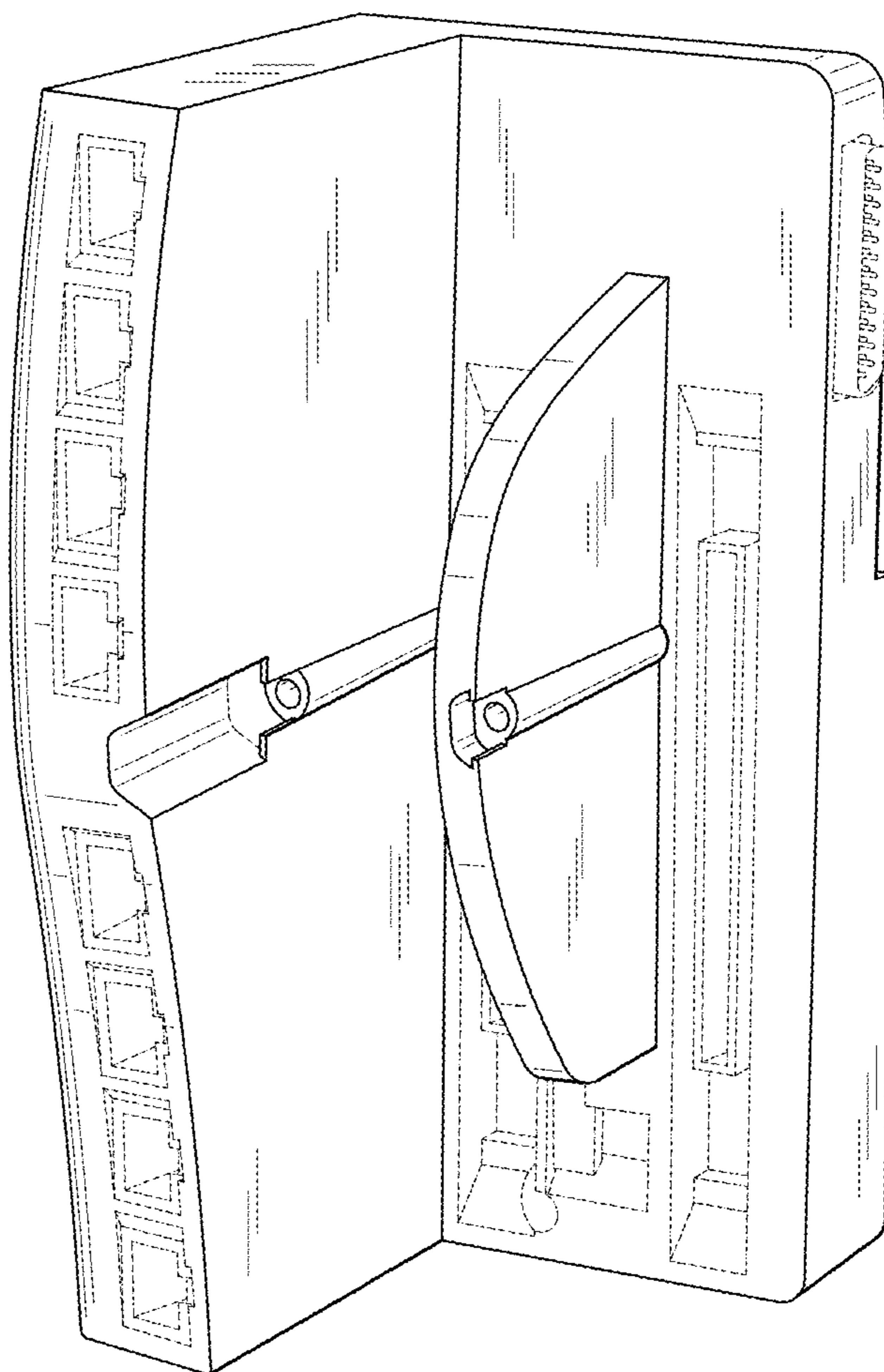

FIG. 9

FIG. 10



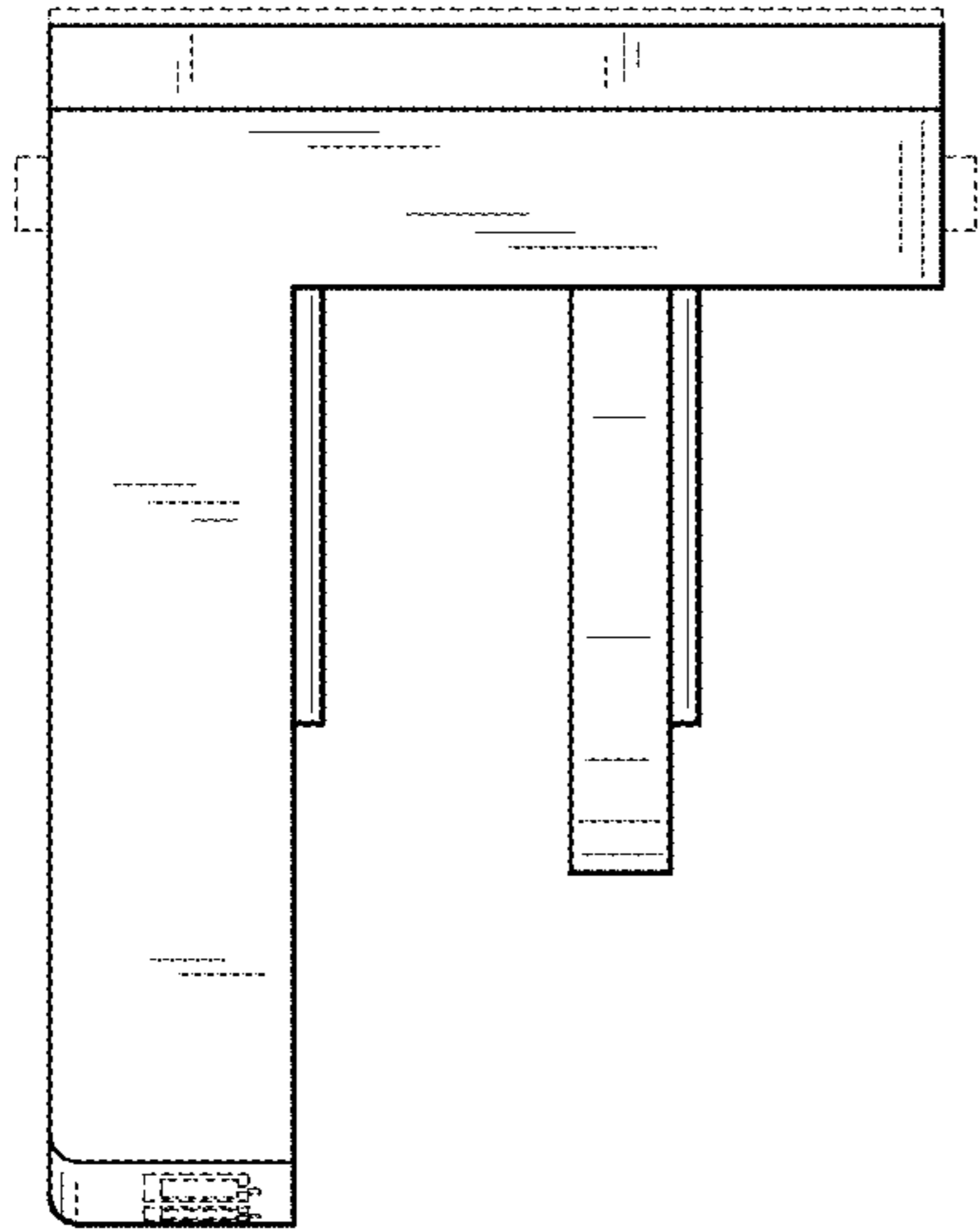

FIG. 1 2

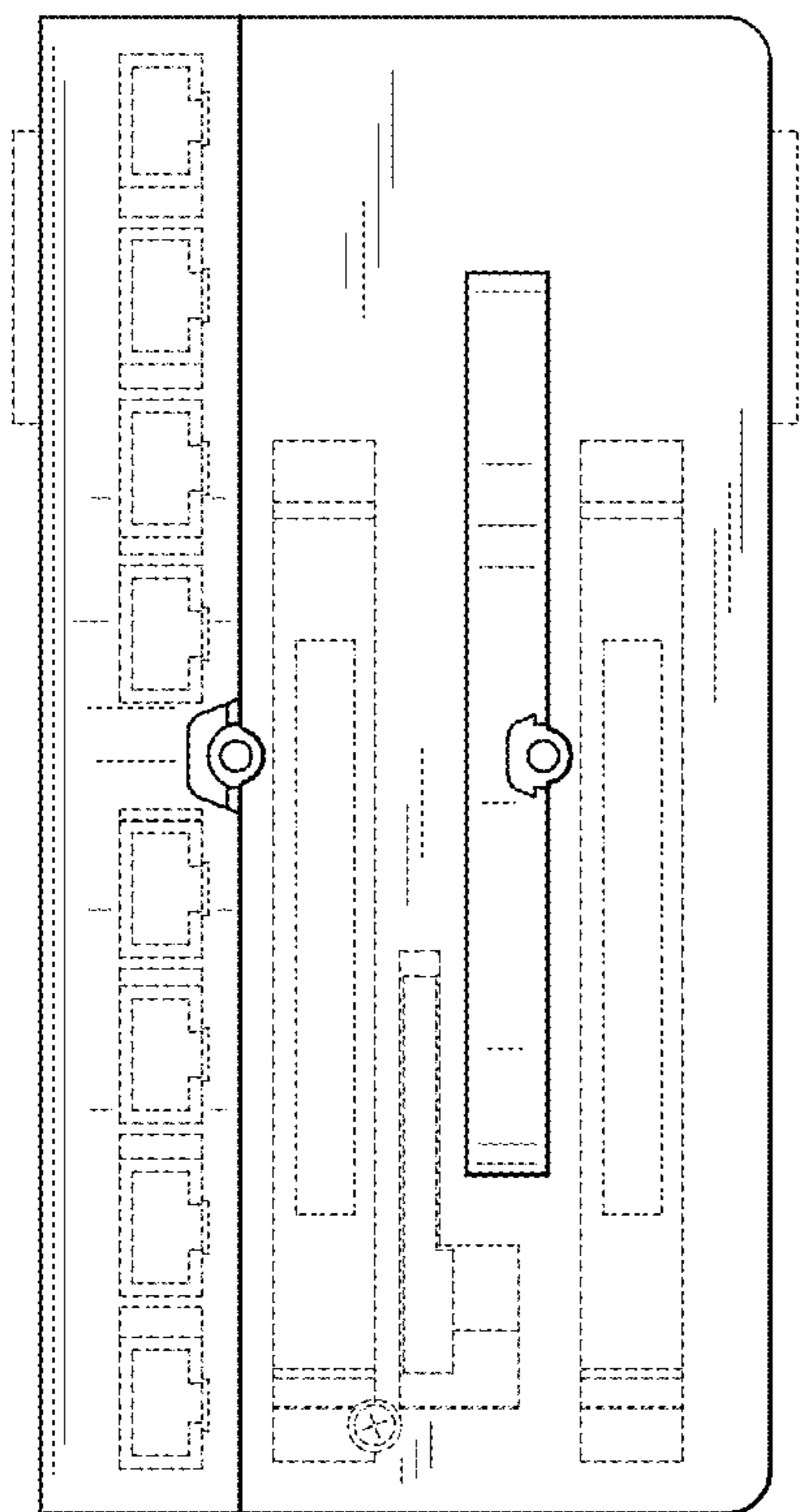

FIG. 1 1

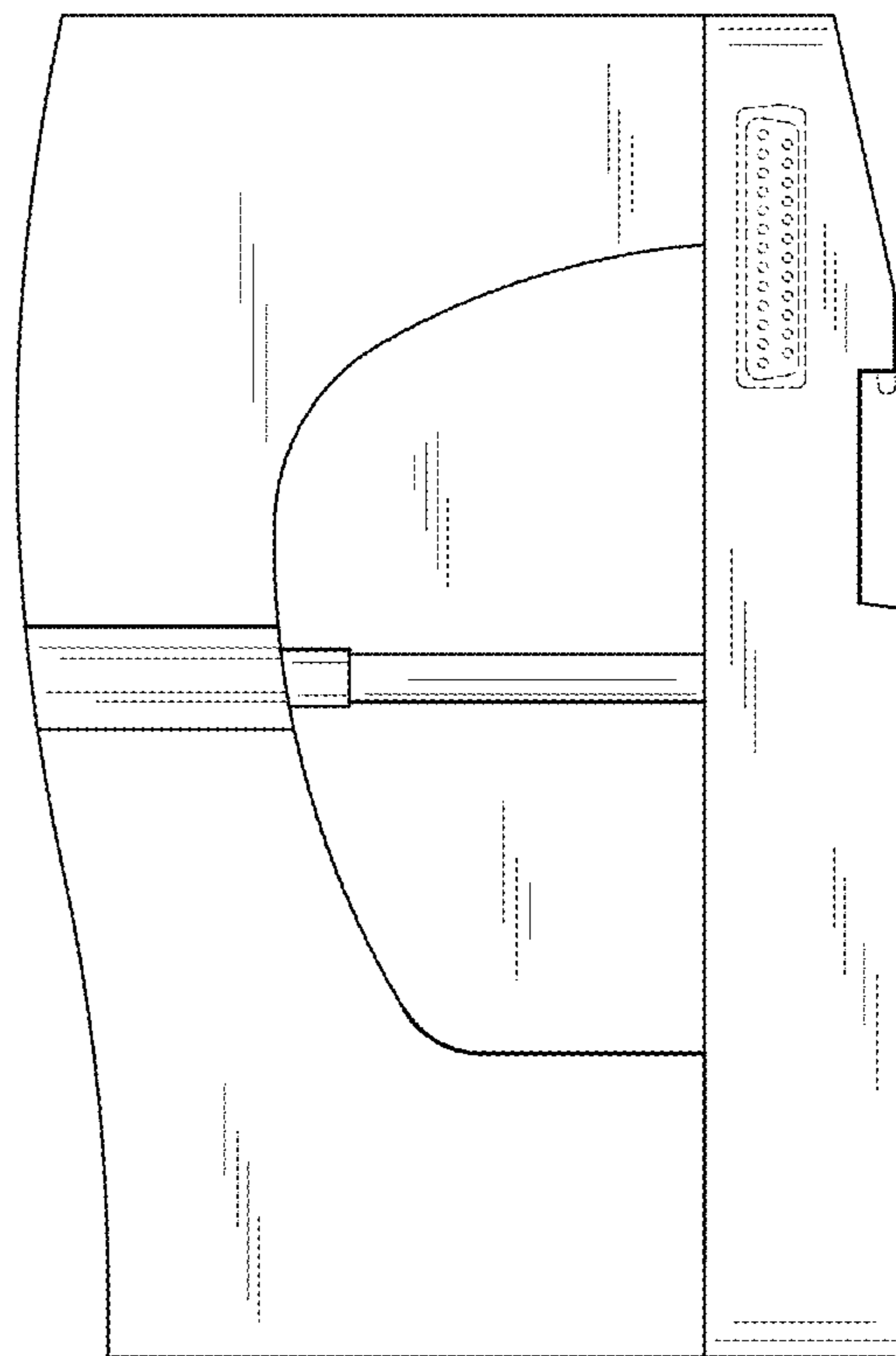

FIG. 1 3

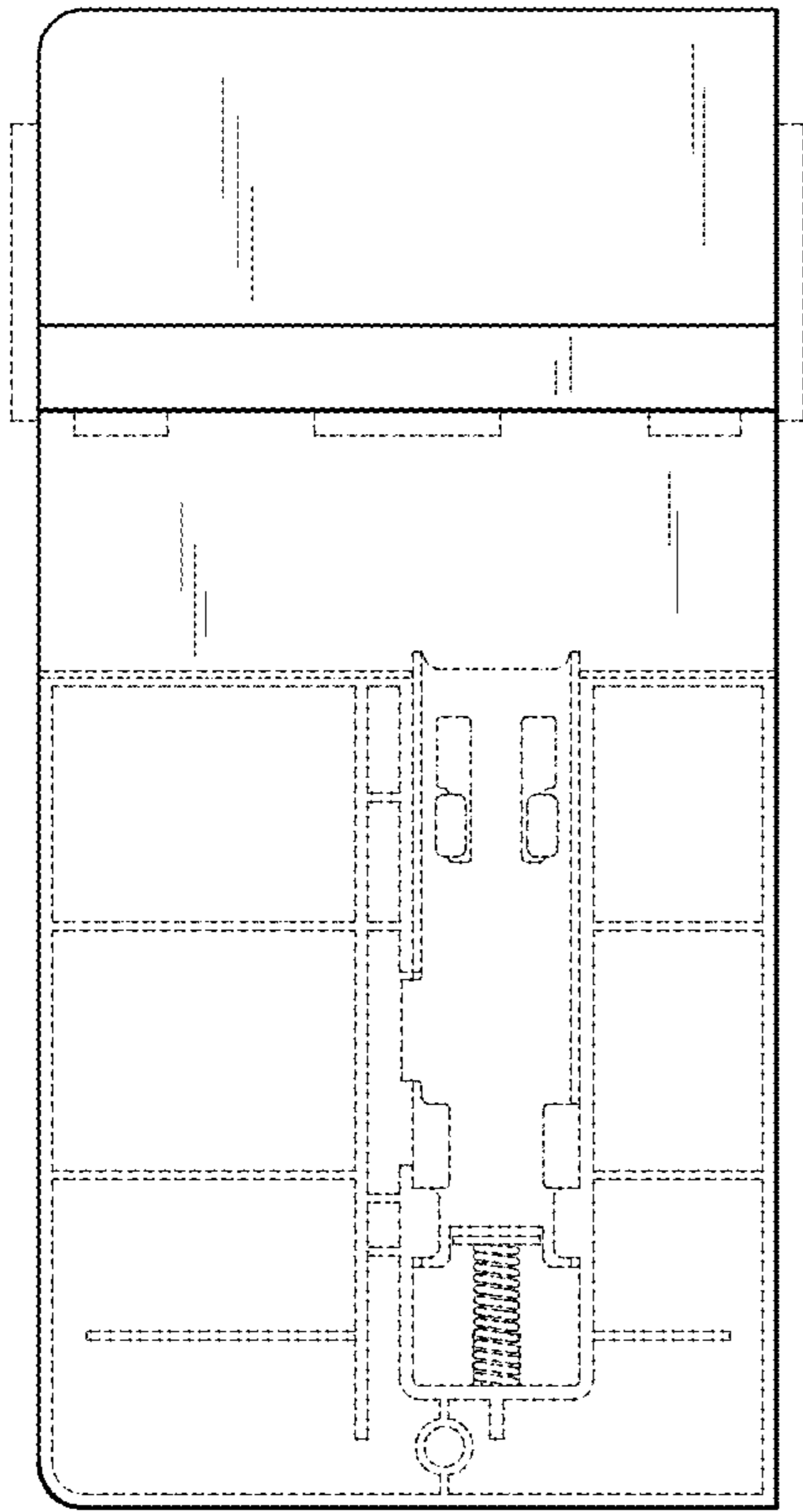

FIG. 15

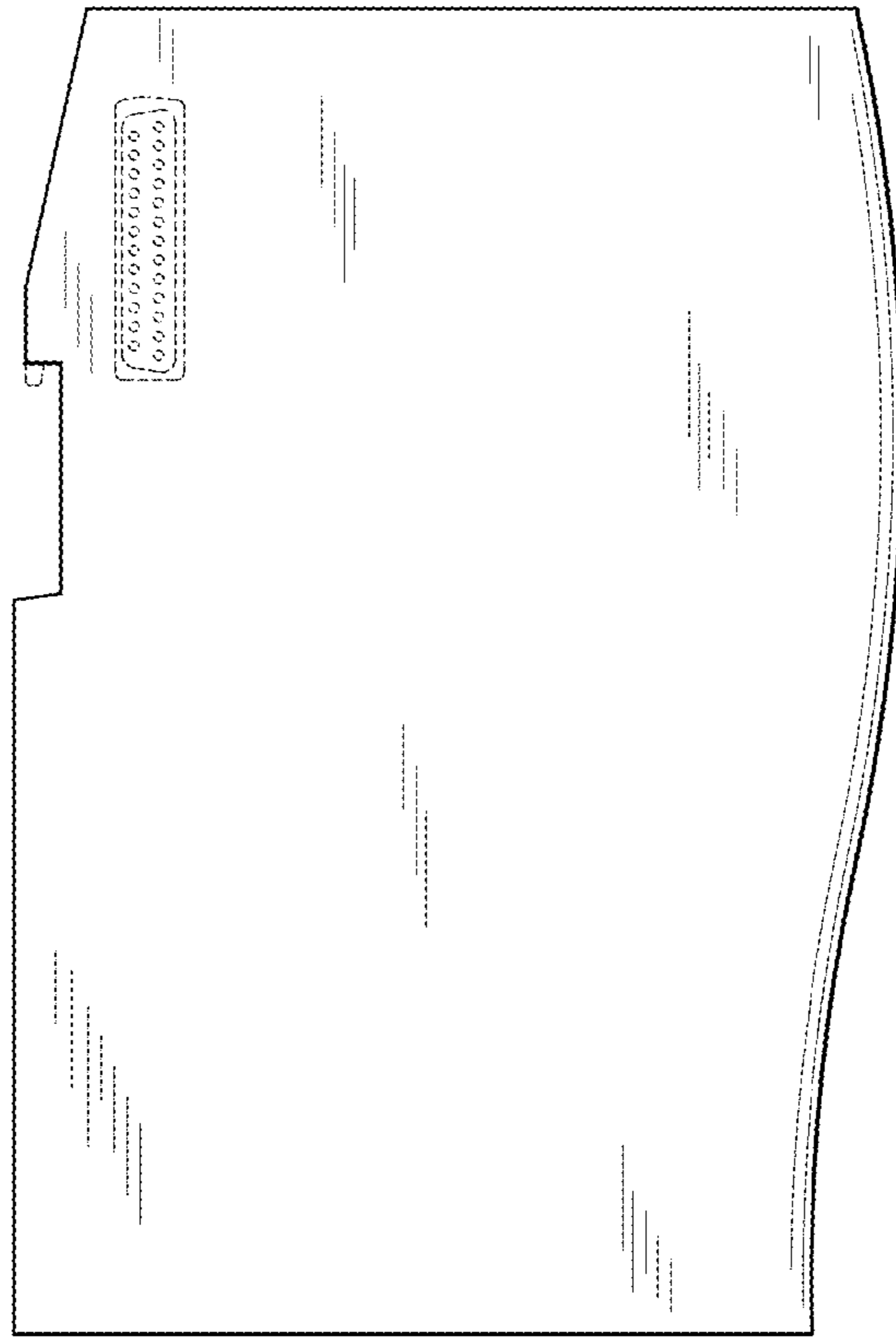

FIG. 14

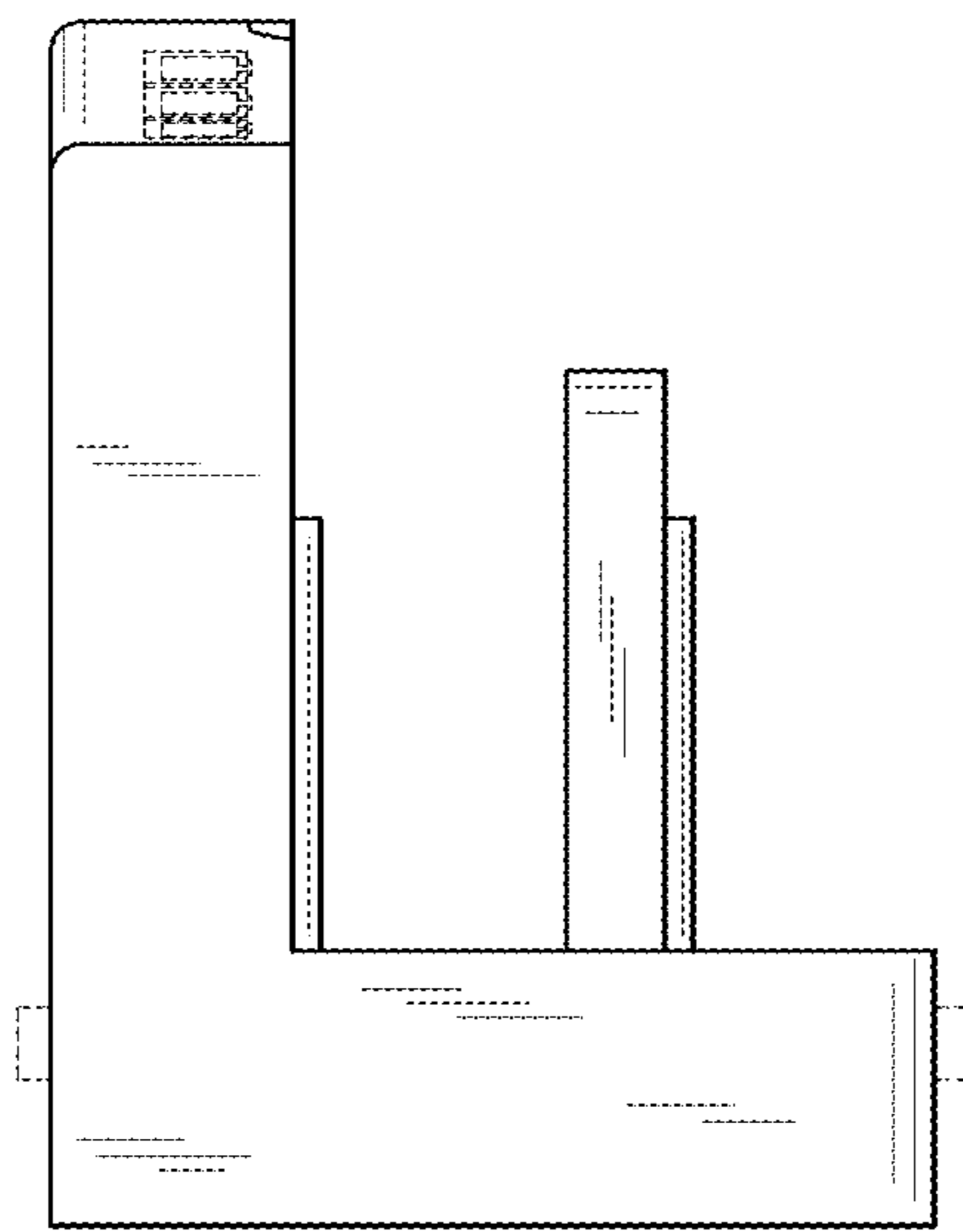

FIG. 16