

US00D769209S

(12) **United States Design Patent**
Byun et al.

(10) **Patent No.:** **US D769,209 S**
(45) **Date of Patent:** **** Oct. 18, 2016**

- (54) **CELLULAR PHONE**
- (71) Applicant: **LG Electronics Inc.**, Seoul (KR)
- (72) Inventors: **Seongchan Byun**, Seoul (KR); **Seihyun Cho**, Seoul (KR); **Sanghoon Song**, Seoul (KR); **Sanghyuck Lee**, Seoul (KR)
- (73) Assignee: **LG Electronics Inc.**, Seoul (KR)
- (**) Term: **14 Years**
- (21) Appl. No.: **29/509,439**
- (22) Filed: **Nov. 18, 2014**
- (30) **Foreign Application Priority Data**
May 30, 2014 (KR) 30-2014-0026672
- (51) **LOC (10) Cl.** **14-03**
- (52) **U.S. Cl.**
USPC **D14/138 AB**
- (58) **Field of Classification Search**
USPC D14/341-347, 137, 138 R, 138 AA, D14/138 AB, 138 C, 138 G, 203.1, 203.3, D14/203.4, 203.7, 129, 130, 147, 218, 247, D14/248, 332, 388, 389, 315-318, 420, 426, D14/429, 489, 492, 496; D10/50, 65, 104.1; D18/6; D21/329, 330; D6/308, 310
CPC .. G06F 1/1613; G06F 1/1647; G06F 1/1641; G06F 3/04883; G06F 3/0486; G06F 3/04847; G06F 3/04845; G06F 3/04817; G06F 3/0484; H04M 1/0279; H04M 1/0281; H04M 1/0283; A63H 33/3016
See application file for complete search history.

- 8,194,399 B2 * 6/2012 Ashcraft G06F 1/1626 257/59
- 8,654,095 B1 * 2/2014 Cho G06F 1/1652 345/173
- 8,810,627 B1 * 8/2014 Cho H04N 5/23238 348/38
- D713,841 S * 9/2014 Lim D14/341
- D716,253 S * 10/2014 Lee D14/138 AB
- D719,540 S * 12/2014 Lee D14/138 AB

(Continued)

Primary Examiner — Barbara Fox
Assistant Examiner — Dana K Weiland
(74) *Attorney, Agent, or Firm* — Morgan, Lewis & Bockius LLP

(57) **CLAIM**

The ornamental design for a cellular phone, as shown and described.

DESCRIPTION

FIG. 1 is a front, right side, perspective view of a cellular phone showing our new design;
FIG. 2 is a front view thereof;
FIG. 3 is a rear view thereof;
FIG. 4 is a left side view thereof;
FIG. 5 is a right side view thereof;
FIG. 6 is a top view thereof;
FIG. 7 is a bottom view thereof;
FIG. 8 is a front, right side, perspective view of the cellular phone in an opened state;
FIG. 9 is a front view in an opened state thereof;
FIG. 10 is a rear view in an opened state thereof;
FIG. 11 is a left side view in an opened state thereof;
FIG. 12 is a right side view in an opened state thereof;
FIG. 13 is a top view in an opened state thereof; and,
FIG. 14 is a bottom view in an opened state thereof.
The broken lines shown in the drawings illustrate portions of the cellular phone that form no part of the claimed design.

(56) **References Cited**

U.S. PATENT DOCUMENTS

- D649,966 S * 12/2011 Chiu D14/341
- D650,380 S * 12/2011 Ballout D14/331

1 Claim, 12 Drawing Sheets

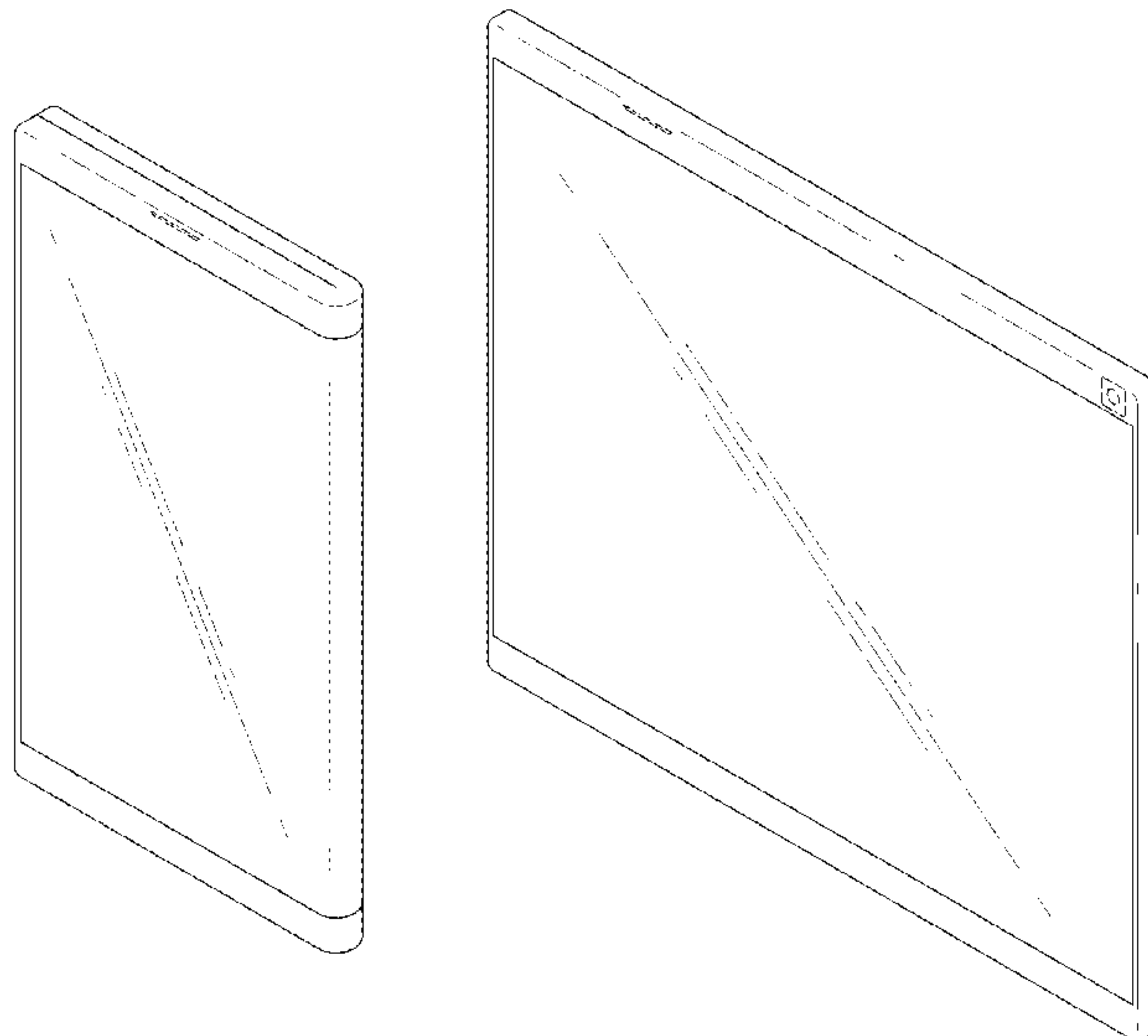

(56)

References Cited

U.S. PATENT DOCUMENTS

8,976,141	B2 *	3/2015	Myers	H04M 1/0268 345/173	2012/0262367	A1 *	10/2012	Chiu	G06F 1/1626 345/156
9,007,226	B2 *	4/2015	Chang	G09G 3/006 340/540	2012/0314399	A1 *	12/2012	Bohn	G06F 1/1616 362/97.1
9,013,864	B2 *	4/2015	Griffin	H04M 1/0216 16/382	2013/0010405	A1 *	1/2013	Rothkopf	H04M 1/0216 361/679.01
9,064,431	B2 *	6/2015	Ahn	G09F 9/33	2013/0044240	A1 *	2/2013	Leskela	H04N 5/2253 348/239
9,122,319	B2 *	9/2015	Kwak	G06F 3/0487	2013/0070431	A1 *	3/2013	Fukuma	G06F 1/1652 361/749
D741,856	S *	10/2015	Yamazaki	D14/341	2013/0135837	A1 *	5/2013	Kemppinen	H04M 1/0235 361/807
9,189,027	B2 *	11/2015	Lee	G06F 1/1641	2013/0216740	A1 *	8/2013	Russell-Clarke	B23K 26/38 428/33
D744,991	S *	12/2015	Lee	D14/248	2013/0307816	A1 *	11/2013	Lee	G06F 1/1652 345/174
D745,001	S *	12/2015	Cho	D14/341	2014/0198036	A1 *	7/2014	Kim	G06F 1/1652 345/156
D745,484	S *	12/2015	Lee	D14/138 G	2014/0293024	A1 *	10/2014	Choi	G06F 1/1601 348/54
D746,285	S *	12/2015	Okabe	D14/345	2014/0353613	A1 *	12/2014	Cheon	H01L 51/0097 257/40
9,250,701	B2 *	2/2016	Kim	G06F 3/01	2015/0049428	A1 *	2/2015	Lee	G06F 1/1641 361/679.27
9,317,067	B2 *	4/2016	Choi	G06F 1/1641	2015/0153778	A1 *	6/2015	Jung	G06F 1/1677 345/156
D755,166	S *	5/2016	Lee	D14/248	2015/0338888	A1 *	11/2015	Kim	G06F 1/1677 345/156
9,342,106	B2 *	5/2016	Nurmi	G06F 1/1652	2015/0378557	A1 *	12/2015	Jeong	G06F 3/0488 715/835
9,348,362	B2 *	5/2016	Ko	G06F 1/1626	2016/0014403	A1 *	1/2016	Stroetmann	G06F 1/1641 348/53
9,349,342	B2 *	5/2016	Zhang	G09G 5/00	2016/0062408	A1 *	3/2016	Lee	G06F 1/1641 345/173
2007/0262916	A1 *	11/2007	Kee	G02F 1/13336 345/1.3	2016/0070306	A1 *	3/2016	Shin	G06F 1/1652 361/679.27
2008/0303782	A1 *	12/2008	Grant	G06F 1/1615 345/156	2016/0132074	A1 *	5/2016	Kim	G06F 1/1652 715/769
2010/0182265	A1 *	7/2010	Kim	G06F 1/1616 345/173	2016/0155967	A1 *	6/2016	Lee	G06F 3/0412 257/88
2010/0210326	A1 *	8/2010	Ladouceur	H04M 1/0214 455/575.3						
2011/0134144	A1 *	6/2011	Moriwaki	G09G 3/3208 345/660						
2011/0241998	A1 *	10/2011	McKinney	G06F 1/1616 345/168						
2012/0033354	A1 *	2/2012	Huang	G09F 9/33 361/679.01						
2012/0044620	A1 *	2/2012	Song	G06F 1/1616 361/679.01						

* cited by examiner

FIG. 1

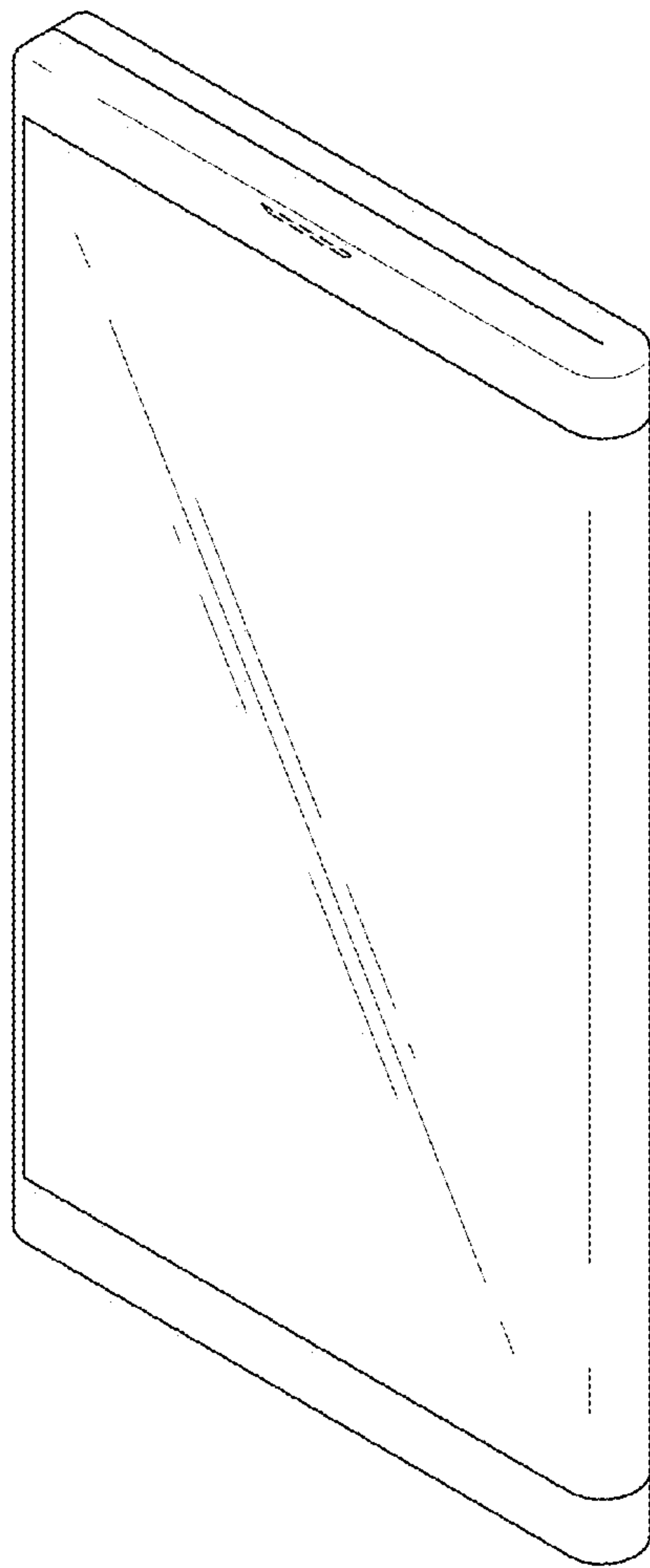

FIG. 2

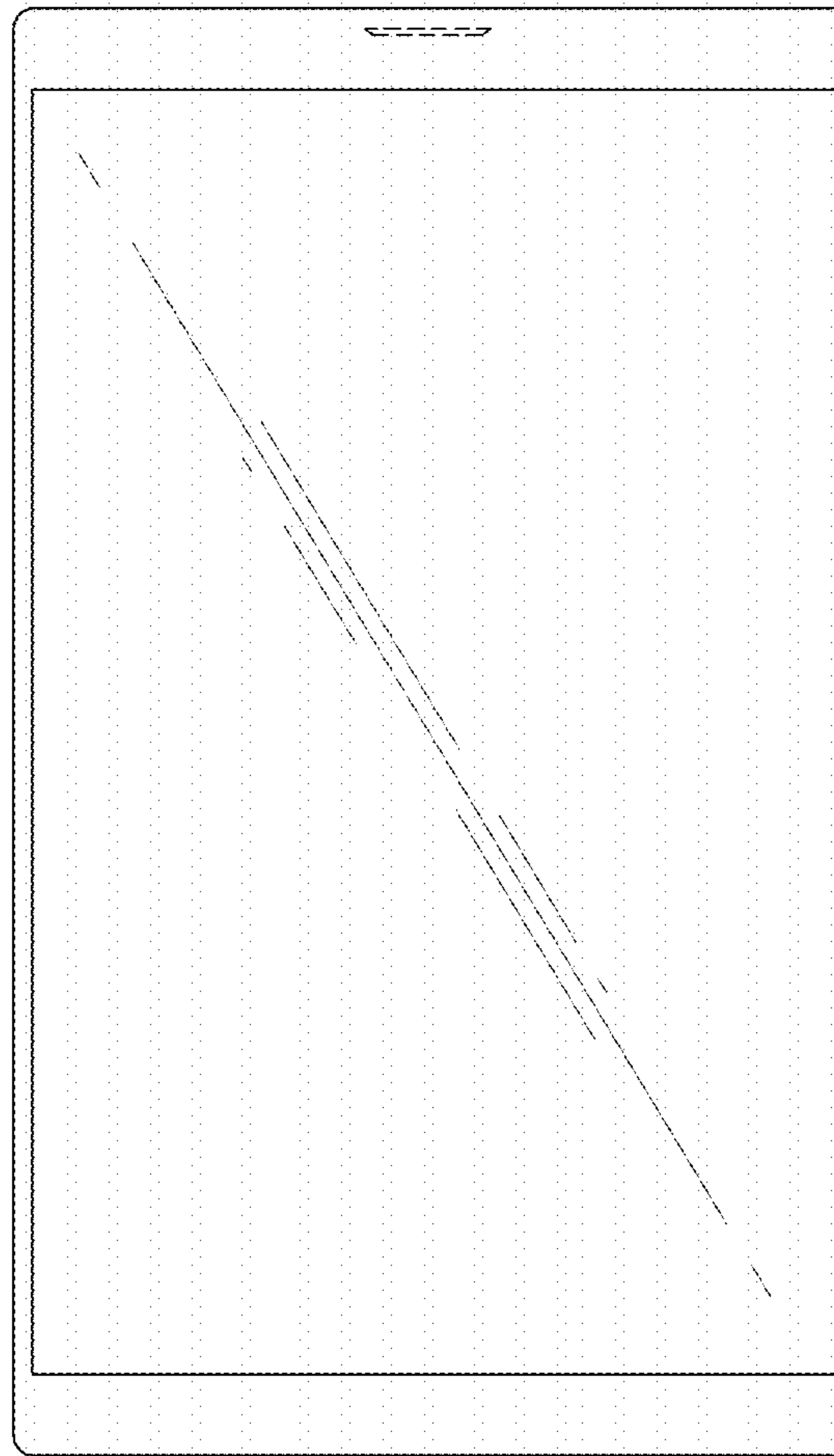

FIG. 3

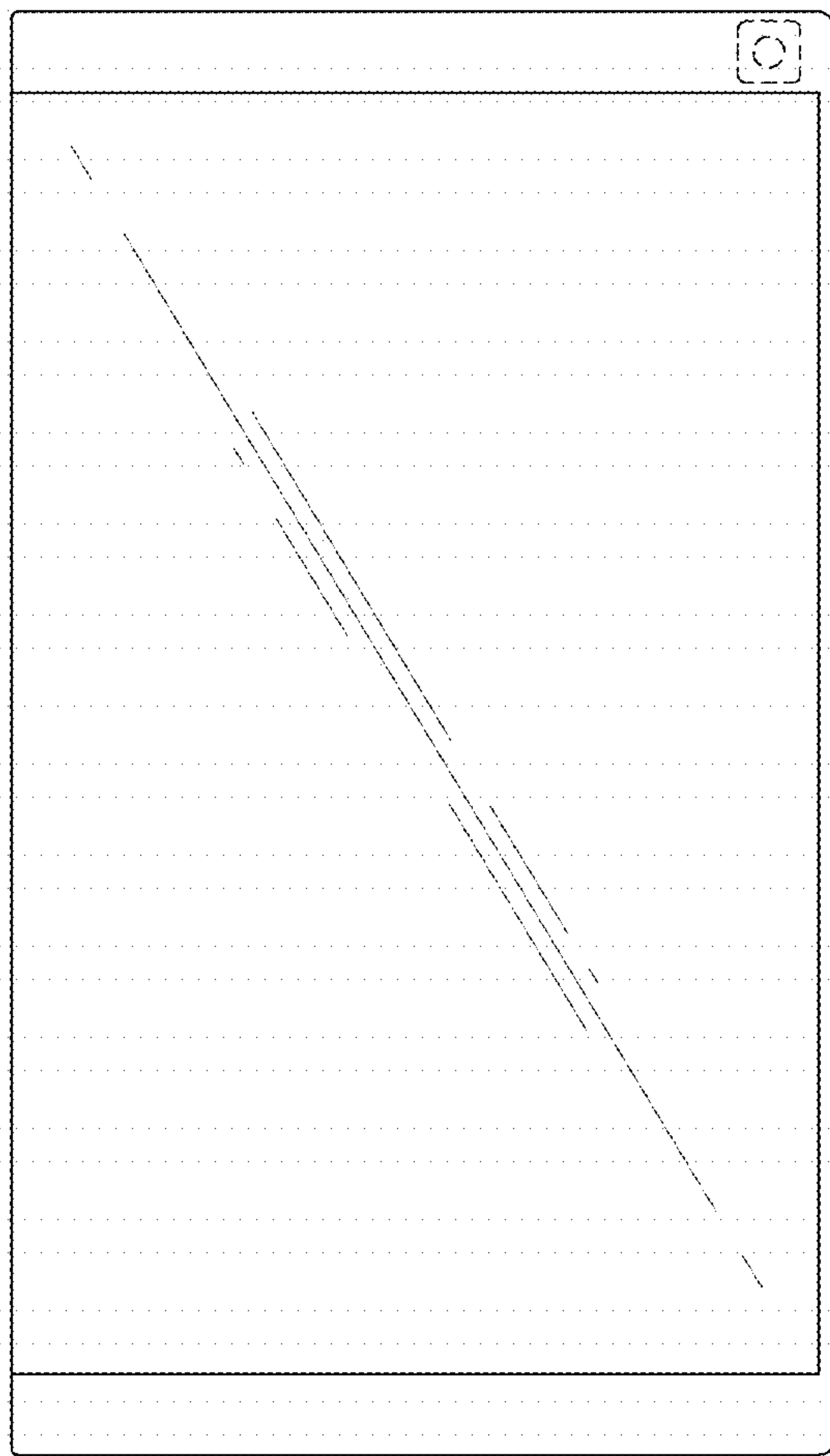

FIG. 4

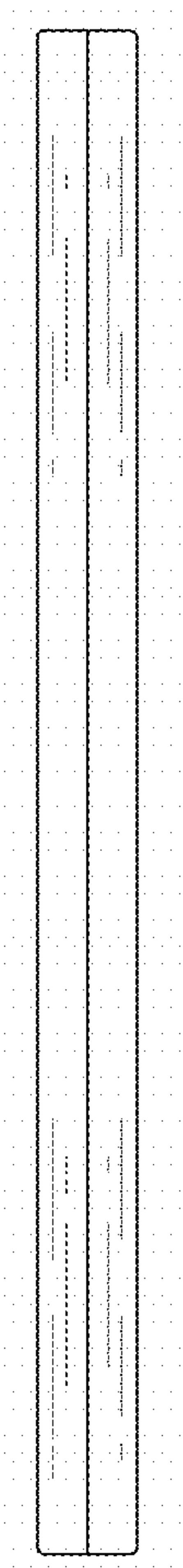

FIG. 5

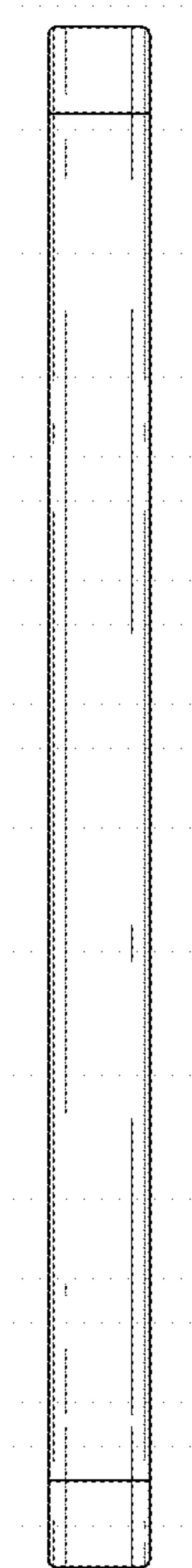

FIG. 6

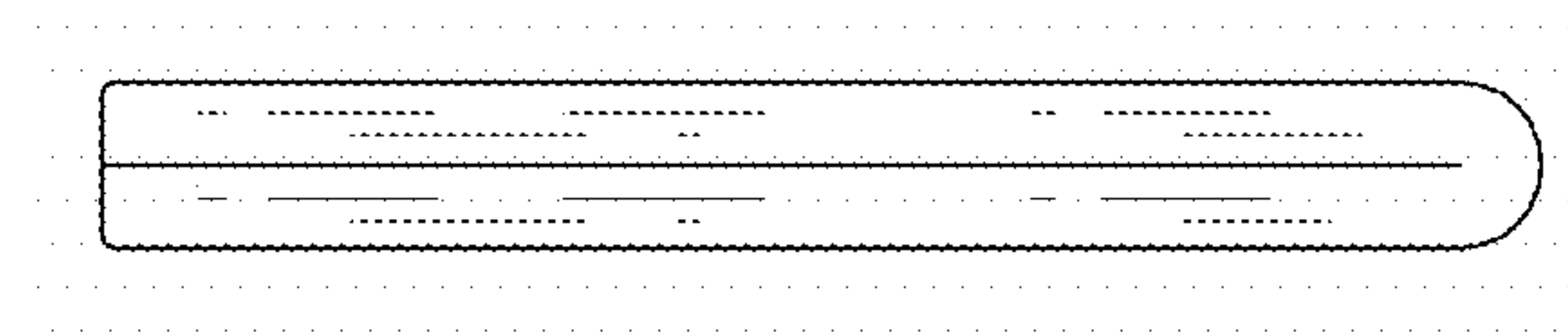

FIG. 7

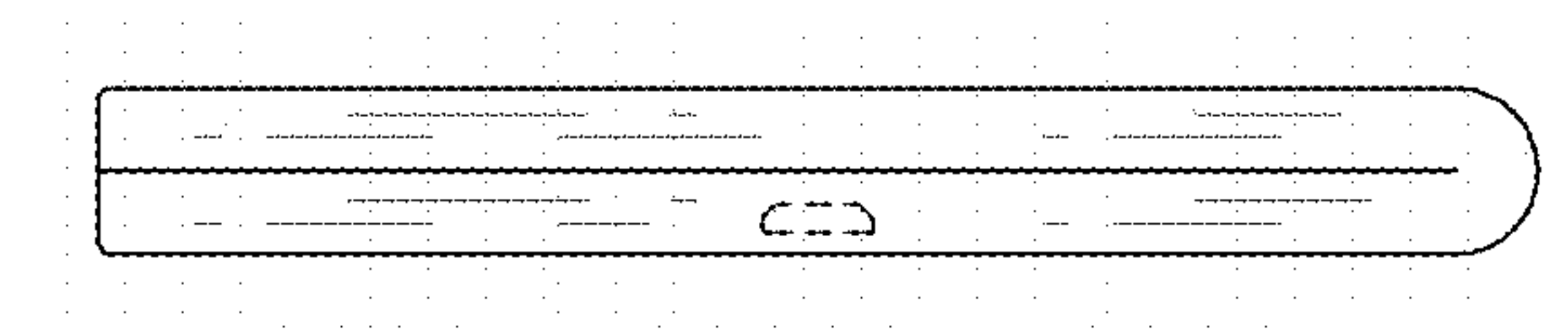

FIG. 8

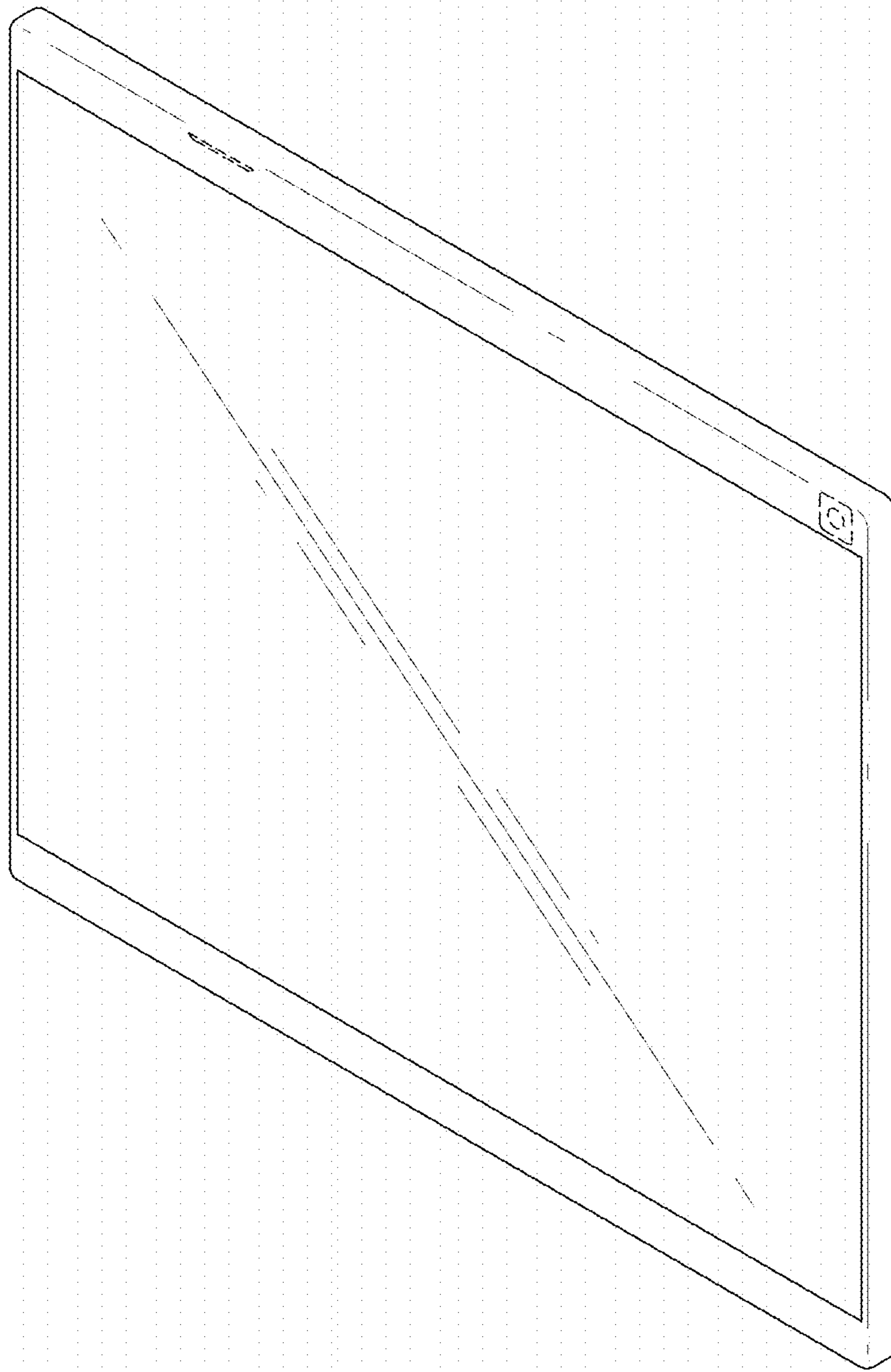

FIG. 9

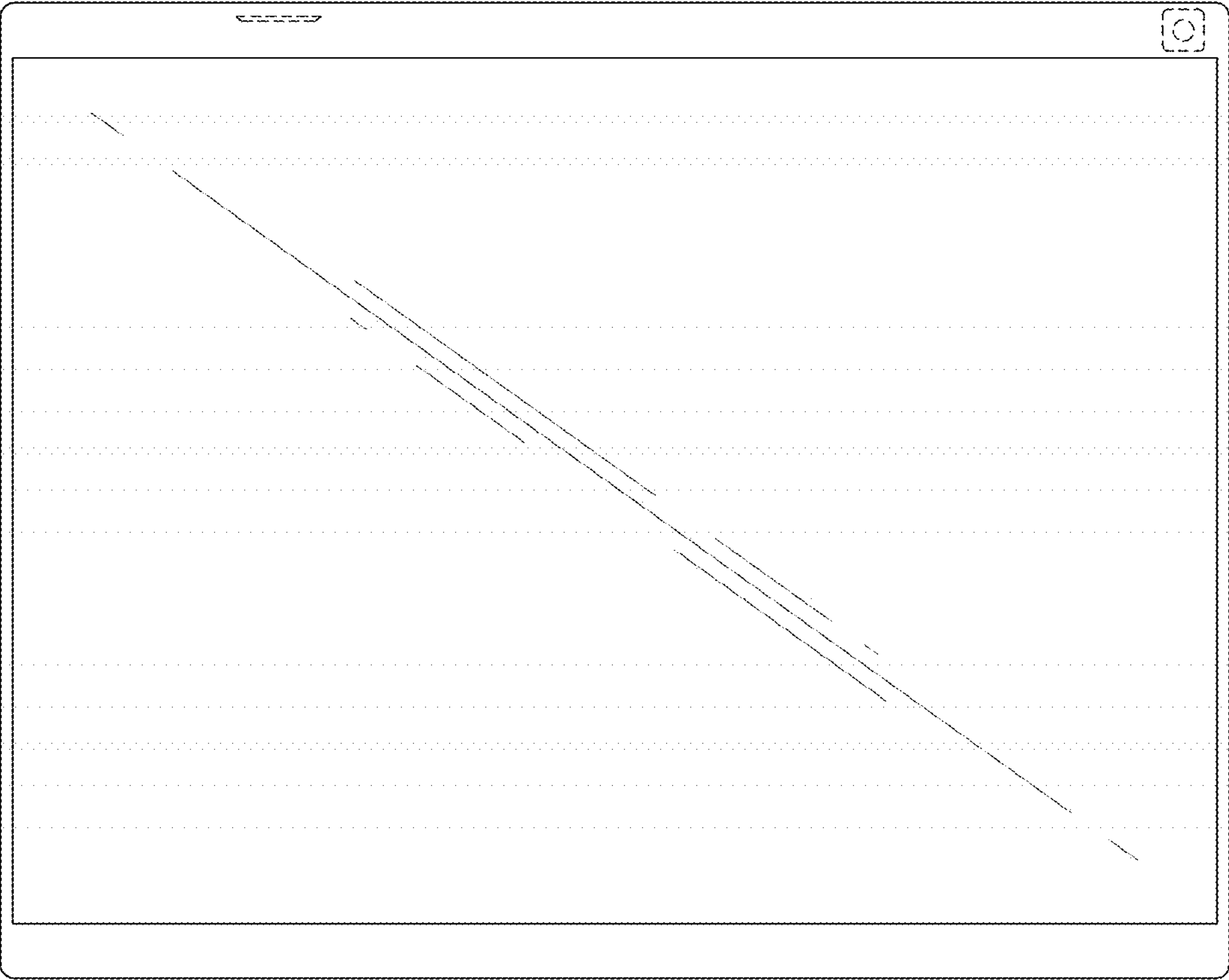

FIG. 10

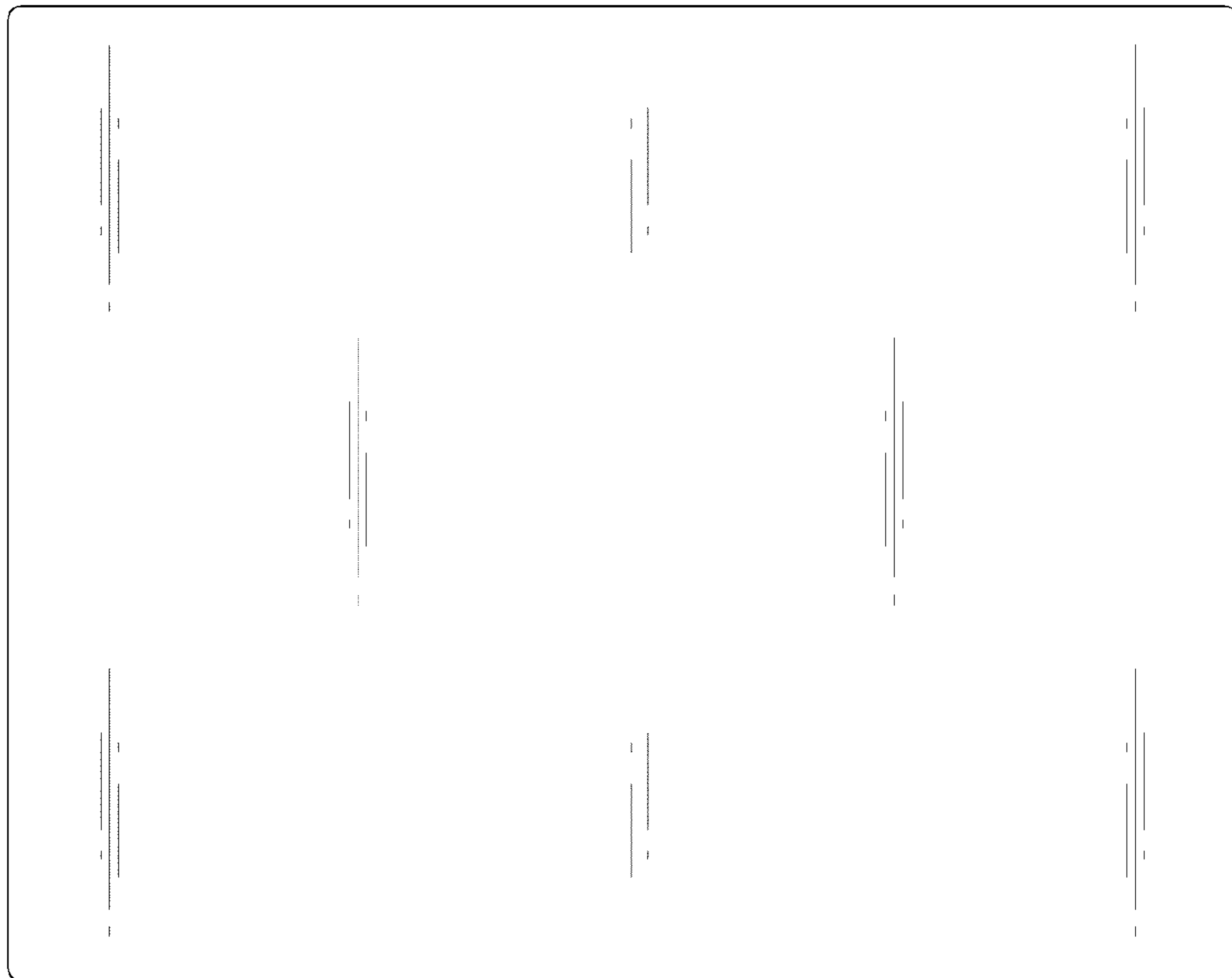

FIG. 11

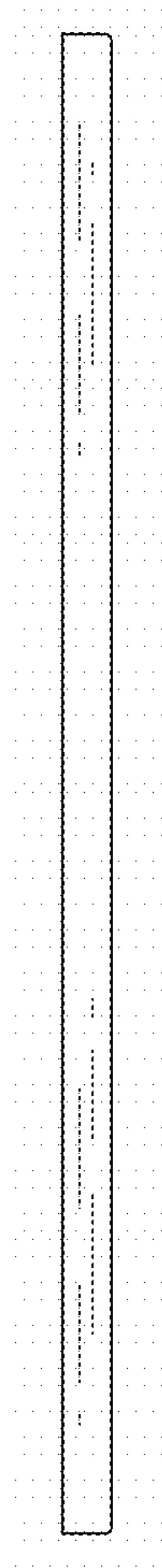

FIG. 12

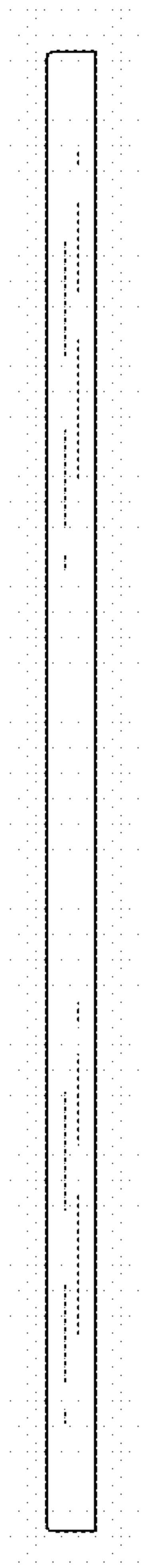

FIG. 13

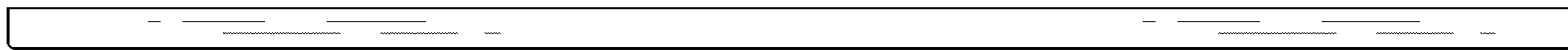

FIG. 14

