

US00D769052S

(12) **United States Design Patent** (10) **Patent No.:** **US D769,052 S**
Lee (45) **Date of Patent:** **** Oct. 18, 2016**

(54) **COOKING PAN FOR USE IN HEATING COOKERS**

(71) Applicant: **Jin Hee Lee**, Seoul (KR)

(72) Inventor: **Jin Hee Lee**, Seoul (KR)

(**) Term: **14 Years**

(21) Appl. No.: **29/526,225**

(22) Filed: **May 7, 2015**

(30) **Foreign Application Priority Data**

Jan. 5, 2015 (KR) 30-2015-0000250

(51) **LOC (10) Cl.** **07-02**

(52) **U.S. Cl.**
USPC **D7/362; D7/352; D7/409**

(58) **Field of Classification Search**

USPC D7/323, 352-362, 543, 545, 549, 550.1, D7/553.1-553.8, 554.1-554.4, 555, 584, D7/586, 688; D9/430-433, 455-456, 737, D9/756-762; D19/92

CPC A21B 3/00; A21B 3/003; A21B 3/13; A21B 3/15; A21B 3/134; A21B 5/00; A21B 5/02; A47J 27/004; A47J 36/022; A47J 36/025; A47J 36/027; A47J 36/38; A47J 36/2483; A47J 37/00; A47J 37/04; A47J 37/067; A47J 37/0676; A47J 37/108; A47J 37/10; A47J 43/28; A47J 43/284; A47G 23/06; B65D 1/22; B65D 1/24; B65D 1/34; B65D 1/36; B65D 81/343; B65D 85/36

See application file for complete search history.

(56) **References Cited**

U.S. PATENT DOCUMENTS

3,664,256 A * 5/1972 Peirce A47J 37/0676 99/425
D223,854 S * 6/1972 Swett D7/392.1
D229,656 S * 12/1973 Humberto Garcia D7/359
D246,411 S * 11/1977 Blanchard 30/303

D252,008 S * 6/1979 Jeambey 426/243
D264,036 S * 4/1982 Pomroy D7/359
D335,795 S * 5/1993 Conti D7/359
6,082,249 A * 7/2000 Su A47J 27/004 99/340
D439,792 S * 4/2001 Hedrington D7/323
D440,490 S * 4/2001 Lizzio D9/428
6,363,842 B1 * 4/2002 Lin A47J 36/38 126/299 D
D458,078 S * 6/2002 Lin D7/362
6,782,801 B1 * 8/2004 Correa A47J 37/067 99/340
D621,650 S * 8/2010 DeLeo D7/354
D653,904 S * 2/2012 Lee D7/362
D678,712 S * 3/2013 Mehler D7/354
D684,808 S * 6/2013 Mehler D7/354
D688,086 S * 8/2013 Lee D7/362
D688,087 S * 8/2013 Lee D7/362
D688,088 S * 8/2013 Lee D7/362
D688,089 S * 8/2013 Lee D7/362
D688,090 S * 8/2013 Lee D7/362
D695,059 S * 12/2013 Mehler D7/354

(Continued)

Primary Examiner — Ricky Pham

(74) *Attorney, Agent, or Firm* — Kile Park Reed & Houtteman PLLC

(57) **CLAIM**

I claim, the ornamental design for a cooking pan for use in heating cookers, as shown and described.

DESCRIPTION

FIG. 1 is a top and front perspective view of a cooking pan for use in heating cookers, showing my new design;
FIG. 2 is a front view thereof;
FIG. 3 is a rear view thereof;
FIG. 4 is a left side view thereof;
FIG. 5 is a right side view thereof;
FIG. 6 is a top plan view thereof;
FIG. 7 is a bottom plan view thereof; and,
FIG. 8 is a reference bottom perspective view showing a state of the bottom of the cooking pan for use in heating cookers.

1 Claim, 8 Drawing Sheets

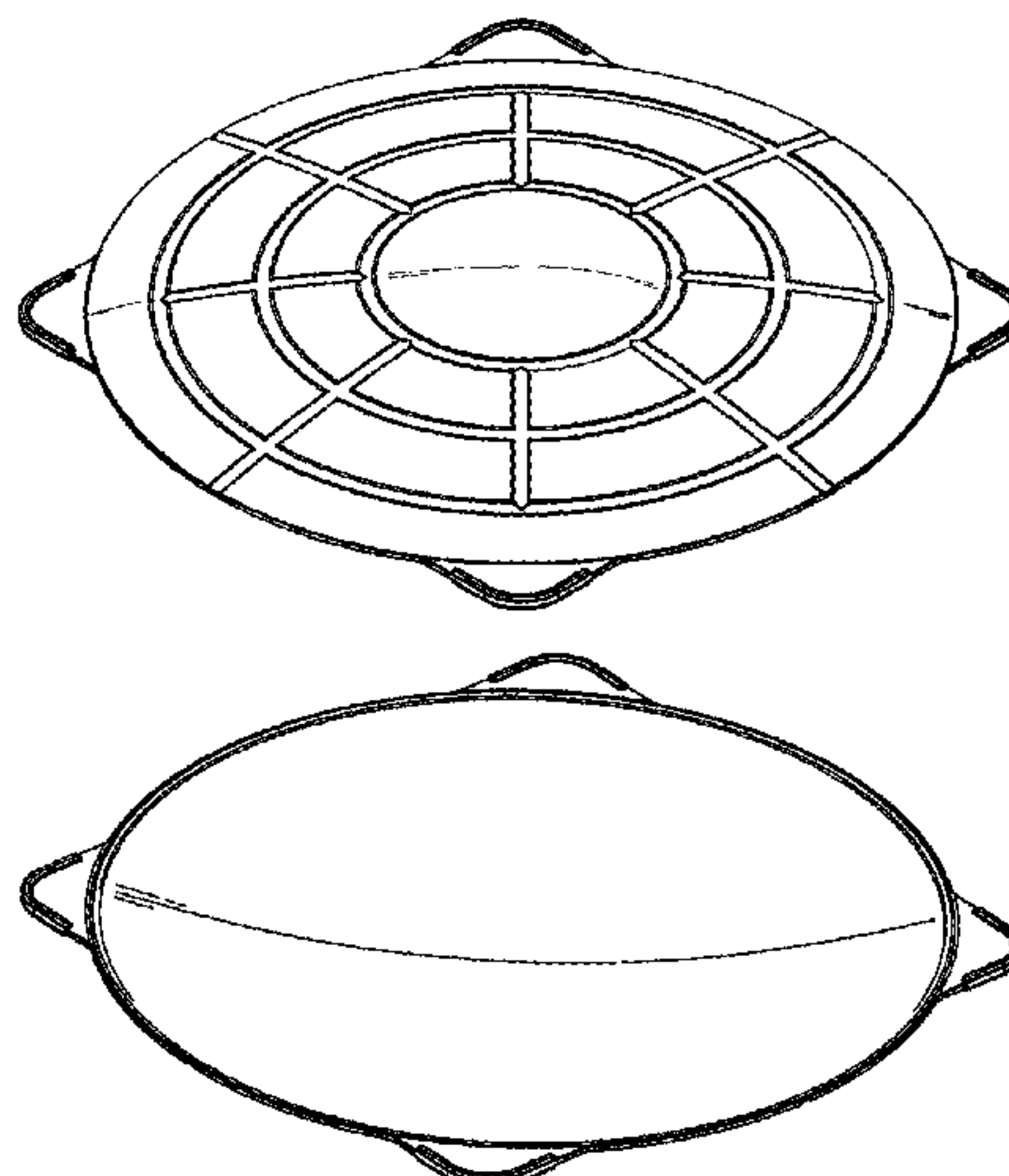

US D769,052 S

Page 2

(56)

References Cited

U.S. PATENT DOCUMENTS

D749,906 S *	2/2016	Lee	D7/362
2009/0095168 A1 *	4/2009	Shu	A47J 37/108 99/425
D707,078 S *	6/2014	Rivera	D7/354

* cited by examiner

FIG. 1

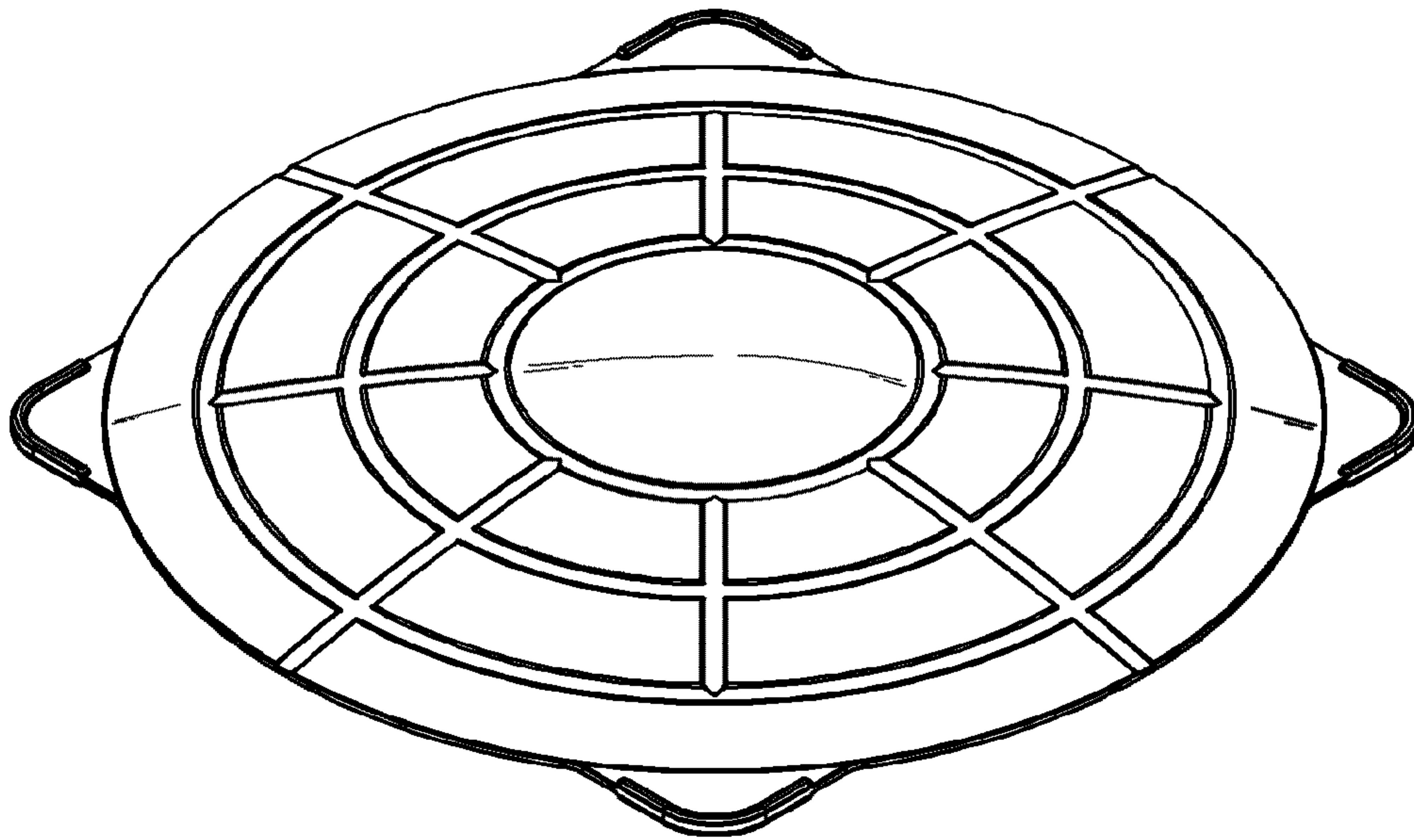

FIG. 2

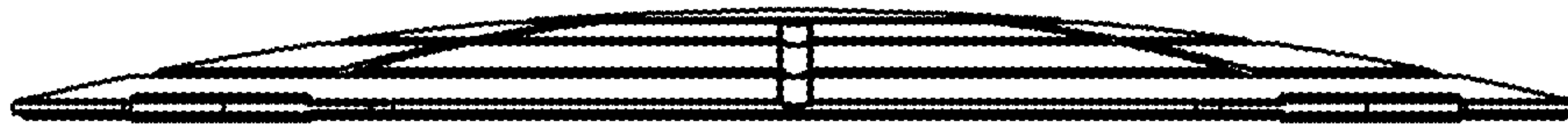

FIG. 3

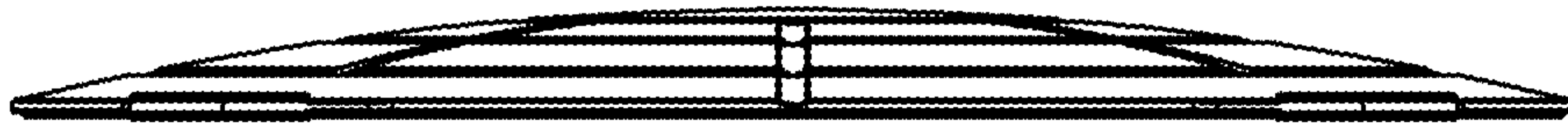

FIG. 4

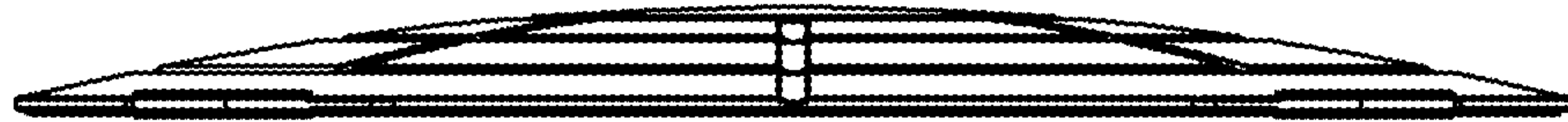

FIG. 5

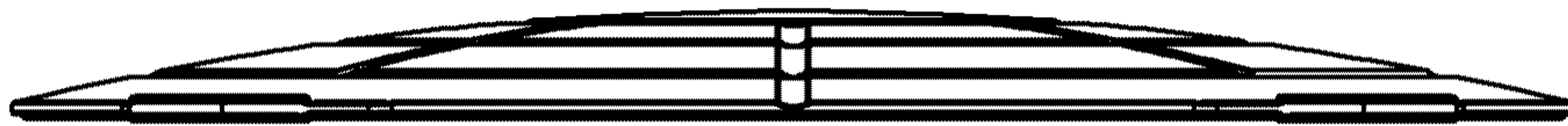

FIG. 6

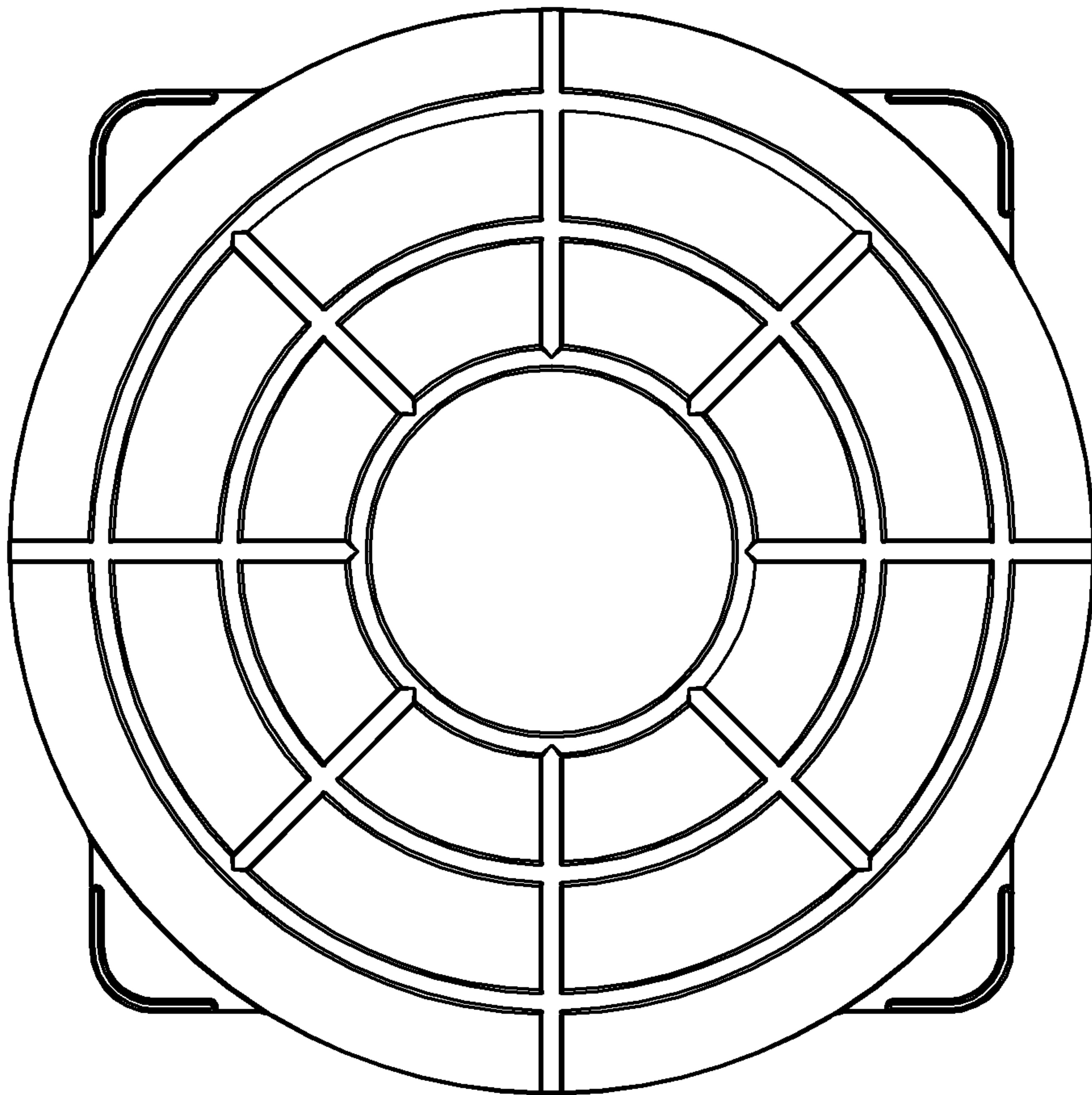

FIG. 7

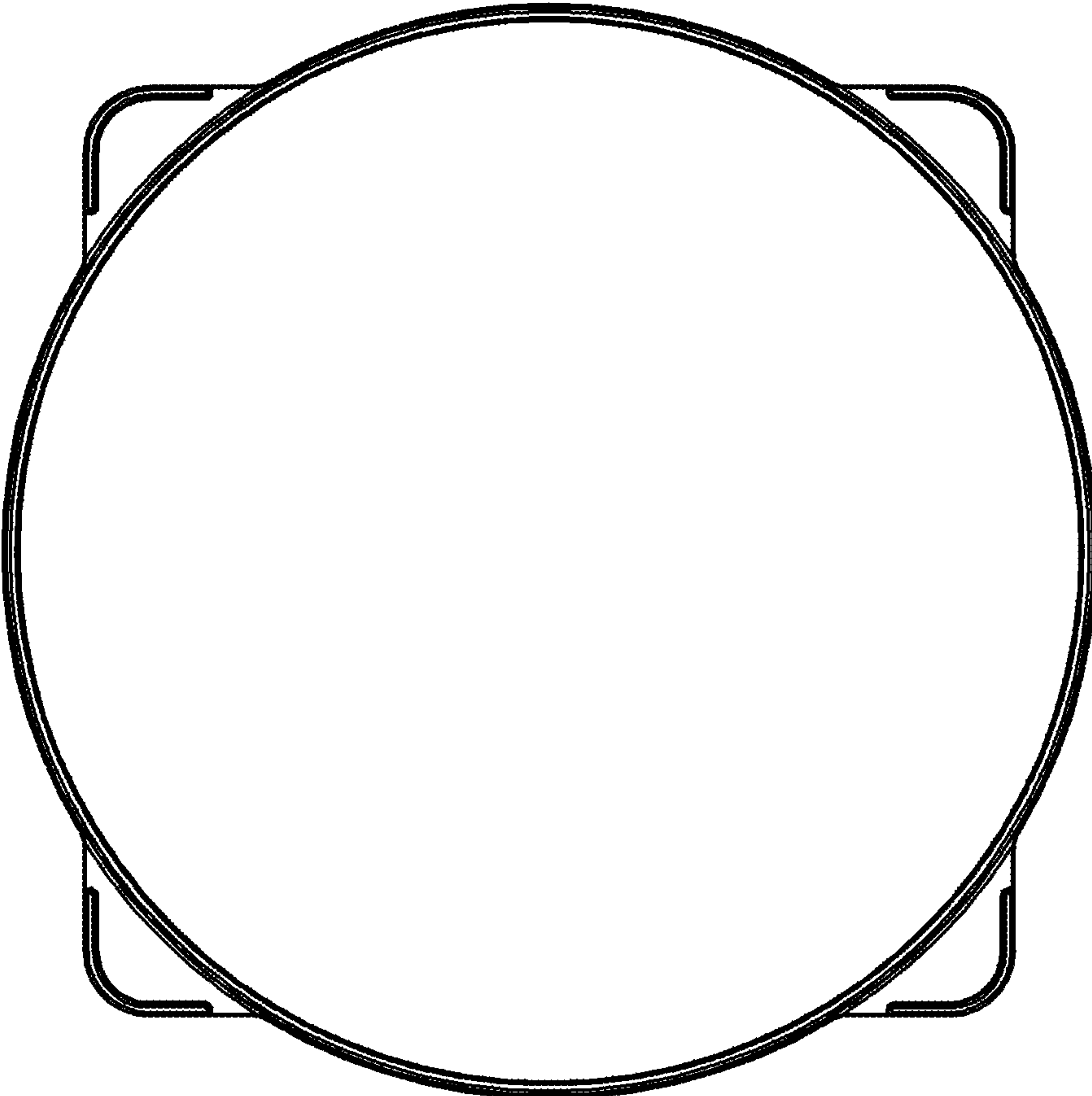

FIG. 8

