



US00D769047S

(12) **United States Design Patent**
Hsu

(10) **Patent No.:** **US D769,047 S**
(45) **Date of Patent:** **** Oct. 18, 2016**

- (54) **JUG WITH RICE-SHAPED EMBOSSING**
- (71) Applicant: **Inno-art Corporation**, Taipei (TW)
- (72) Inventor: **Sung-Ming Hsu**, Taipei (TW)
- (73) Assignee: **INNO-ART CORPORATION**, Taipei (TW)
- (**) Term: **14 Years**
- (21) Appl. No.: **29/518,080**
- (22) Filed: **Feb. 19, 2015**
- (30) **Foreign Application Priority Data**
Nov. 11, 2014 (TW) 103306590
- (51) **LOC (10) Cl.** **07-01**
- (52) **U.S. Cl.**
USPC **D7/319; D7/317**
- (58) **Field of Classification Search**
USPC D7/300.1, 510, 511, 598, 599, 600, 608,
D7/515, 523, 312, 306, 300, 316-319, 400,
D7/398; 169/71; D9/680; D22/112;
102/486; D29/125, 126; 220/713, 715,
220/739; D23/209; D10/46.2; 210/264,
210/321.6
CPC A47G 19/22; A47G 21/18; A47G 19/00;
A47G 19/12; A47G 19/127; A62C 13/003;
A47J 43/044
See application file for complete search history.

- (56) **References Cited**
U.S. PATENT DOCUMENTS
D64,326 S * 3/1924 Smyth D7/523
D76,670 S * 10/1928 Dawson 65/61
D78,014 S * 3/1929 Dunbar D7/523
D80,330 S * 1/1930 Mosser D7/523

- D114,054 S * 4/1939 Beatty D7/530
- D191,620 S * 10/1961 Bloch D7/523
- D200,111 S * 1/1965 Traner et al. D7/523
- D243,434 S * 2/1977 Cone D7/319
- D351,964 S * 11/1994 Zivin D7/302
- 5,425,579 A * 6/1995 Sampson B01F 7/162
366/130
- D377,291 S * 1/1997 Ahern, Jr. D7/318
- D384,237 S * 9/1997 Hess D7/317
- D392,149 S * 3/1998 Smith D7/307
- 6,287,247 B1 * 9/2001 Dees B31B 43/00
493/58
- D492,547 S * 7/2004 Hsu D7/523
- D510,681 S * 10/2005 Liu D7/523
- D552,917 S * 10/2007 Hurlbut D7/306
- D603,653 S * 11/2009 Wong D7/509
- 8,579,133 B2 * 11/2013 Marcus A61J 9/08
206/459.5
- 8,608,018 B2 * 12/2013 Babinsky B65D 81/3869
206/737
- D703,479 S * 4/2014 Norland D7/376

* cited by examiner

Primary Examiner — Marianne Pandozzi
(74) *Attorney, Agent, or Firm* — Muncy, Geissler, Olds & Lowe, P.C.

(57) **CLAIM**
The ornamental design for a jug with rice-shaped embossing, as shown and described.

DESCRIPTION

FIG. 1 is a jug with rice-shaped embossing showing my new design;
FIG. 2 is a front view thereof;
FIG. 3 is a rear view thereof;
FIG. 4 is a right-side view thereof;
FIG. 5 is a left-side view thereof;
FIG. 6 is a top view thereof; and,
FIG. 7 is a bottom view thereof.

1 Claim, 6 Drawing Sheets

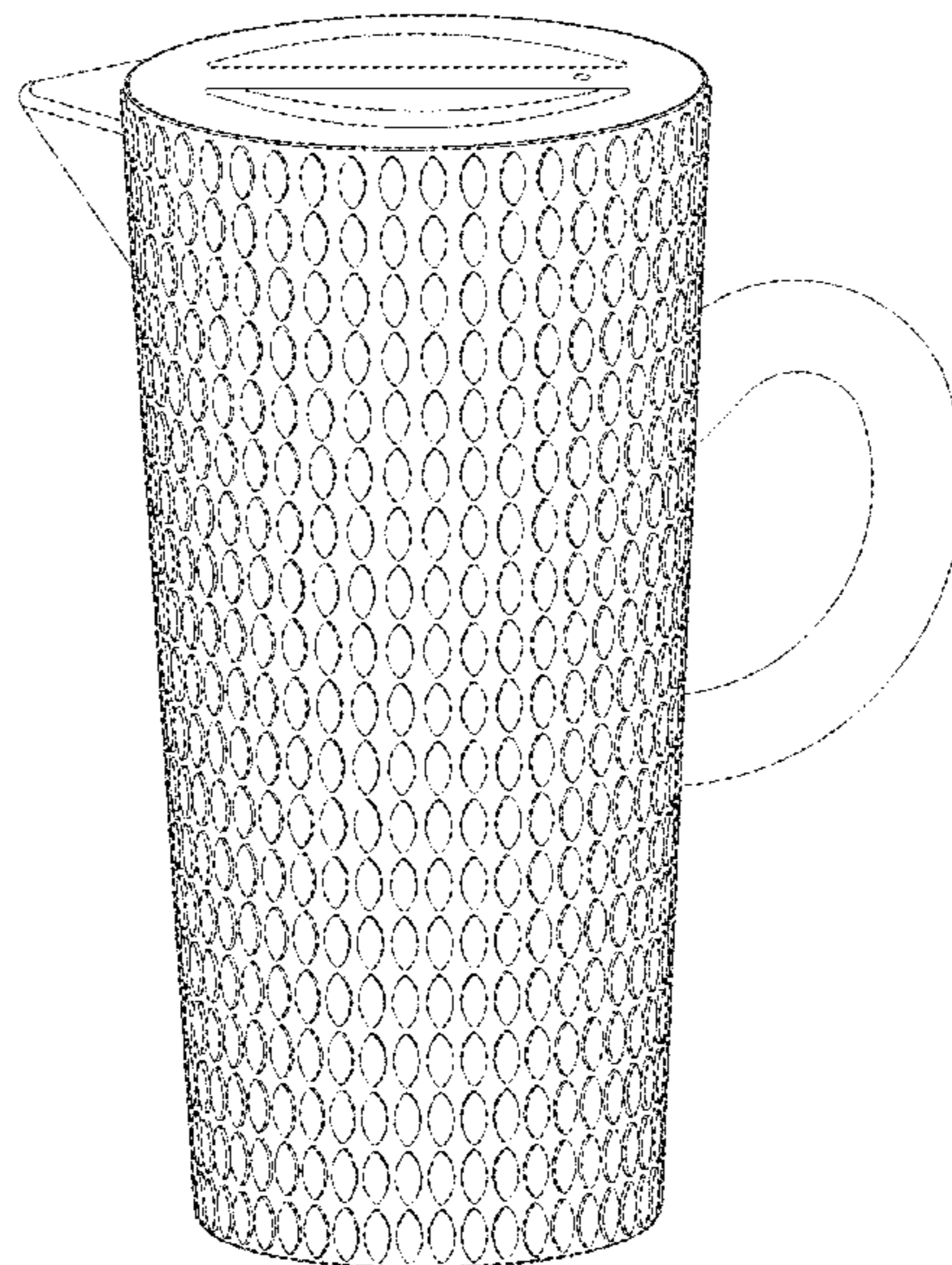

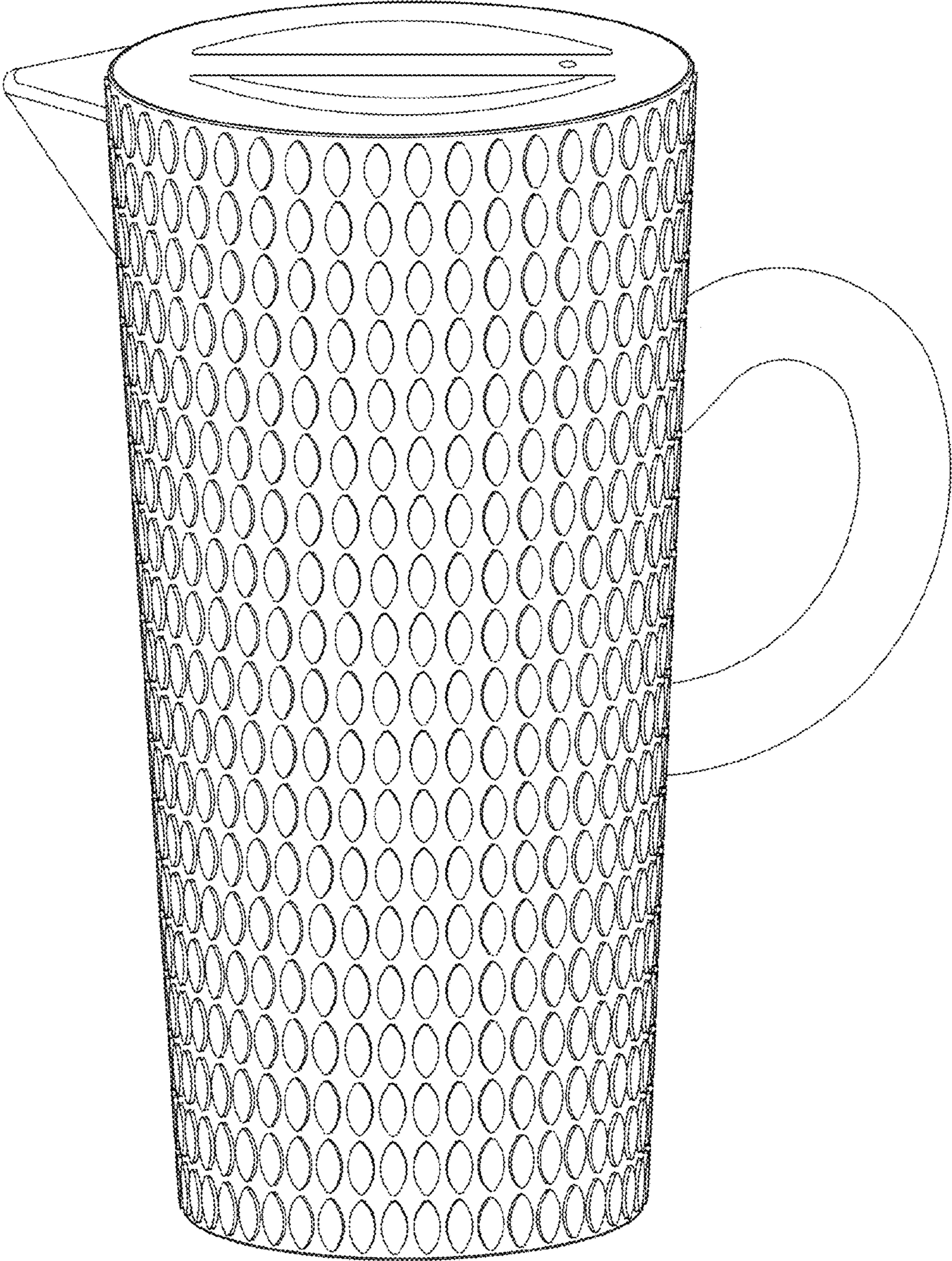

FIG. 1

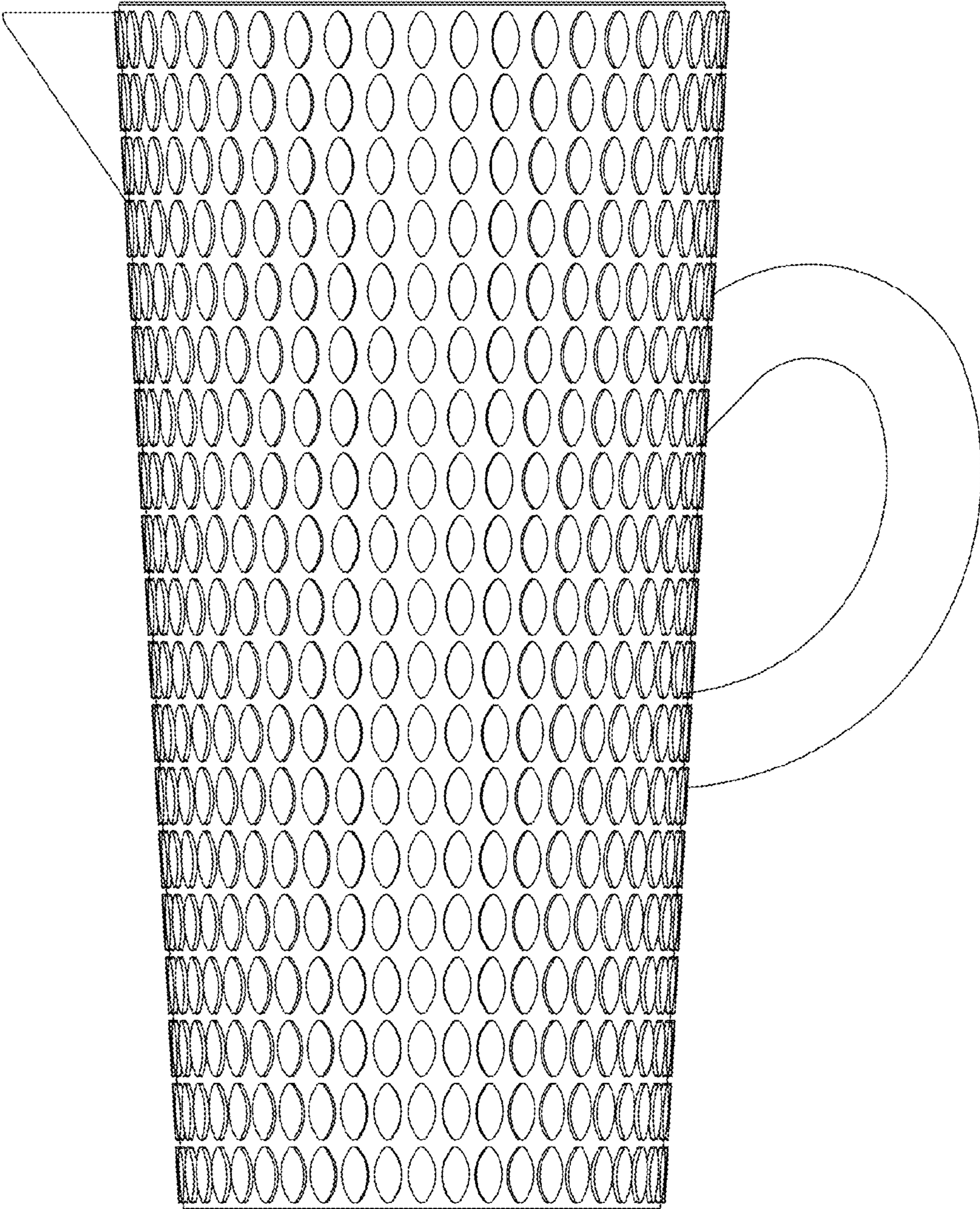

FIG. 2

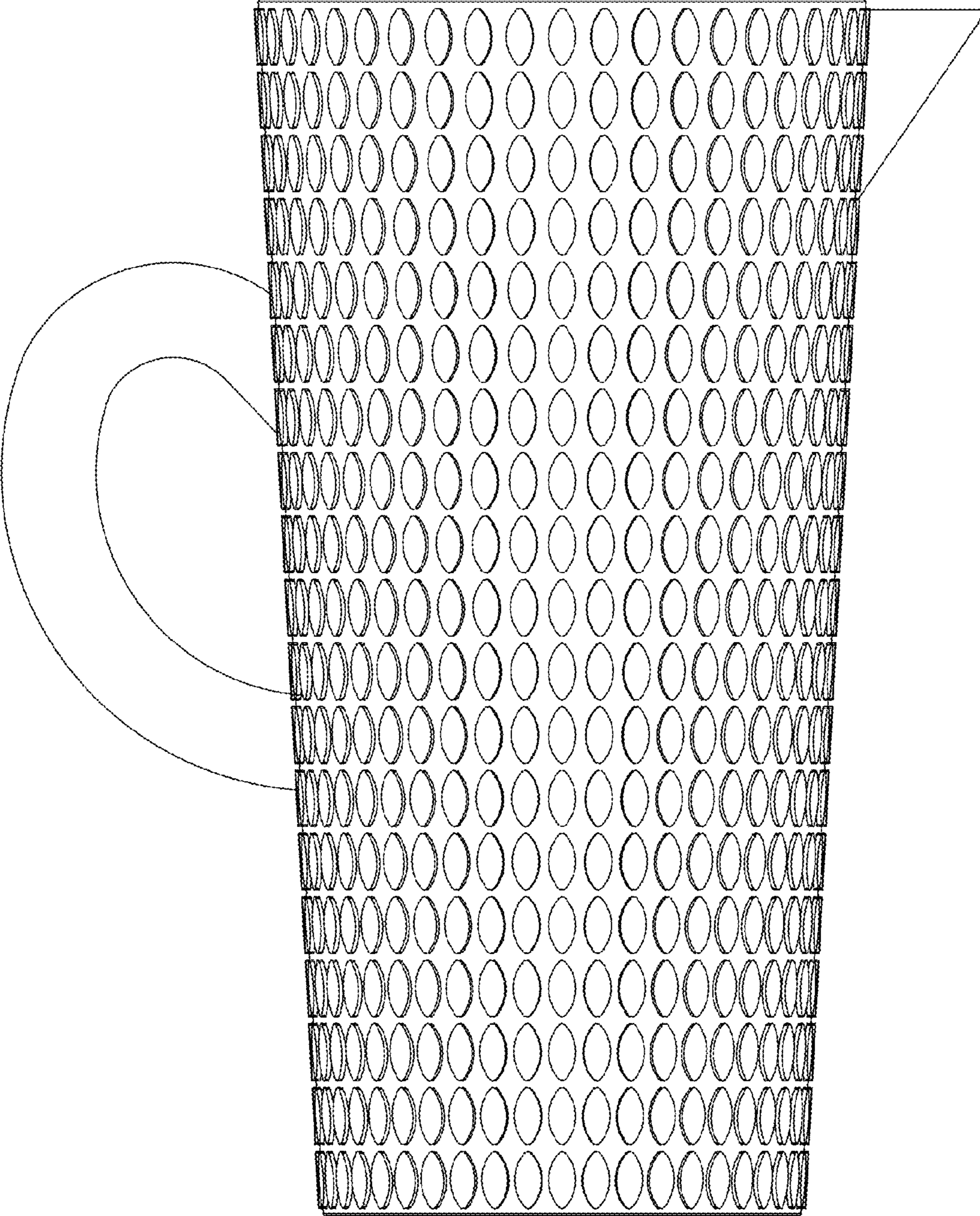

FIG. 3

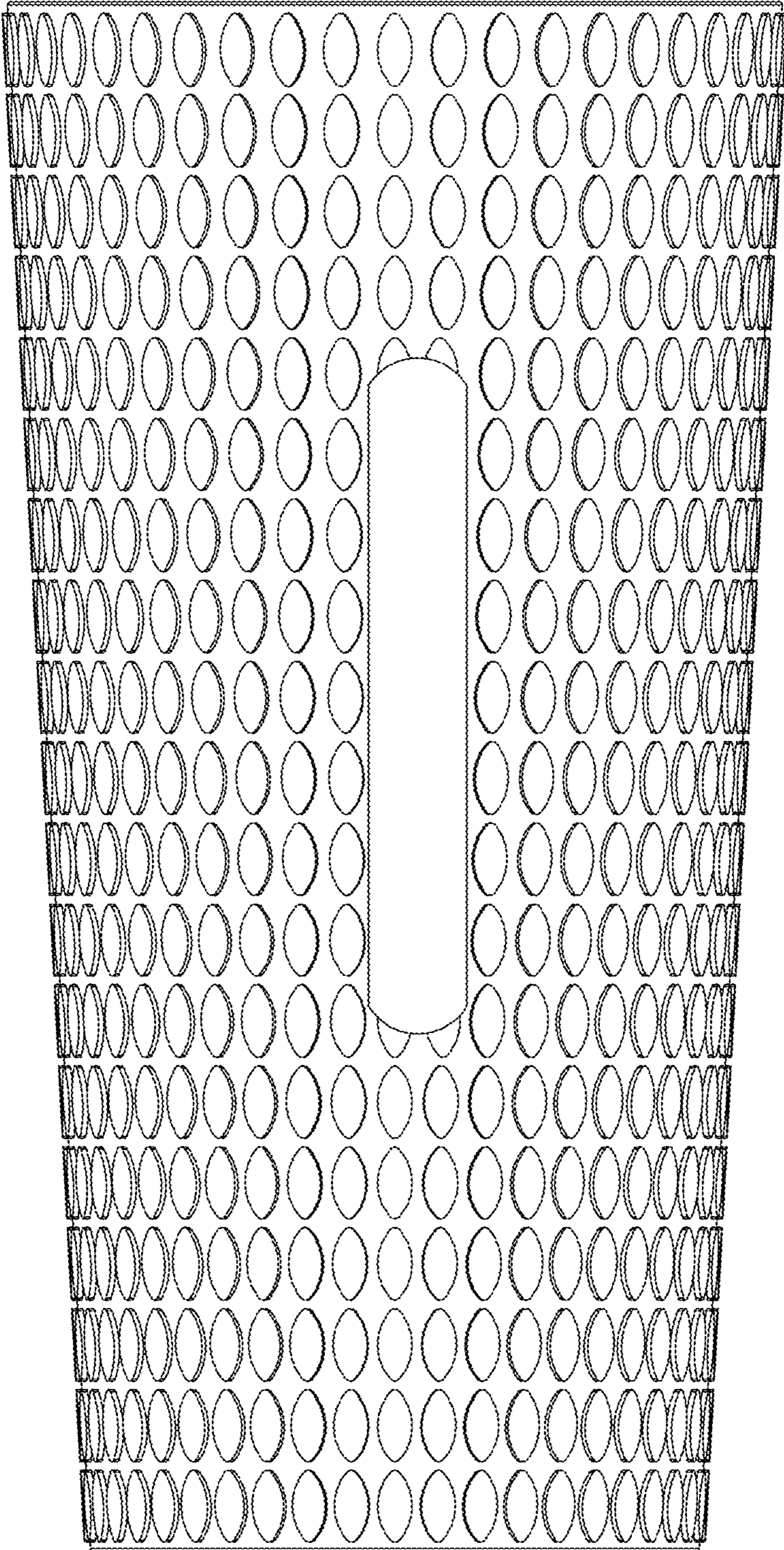

FIG. 4

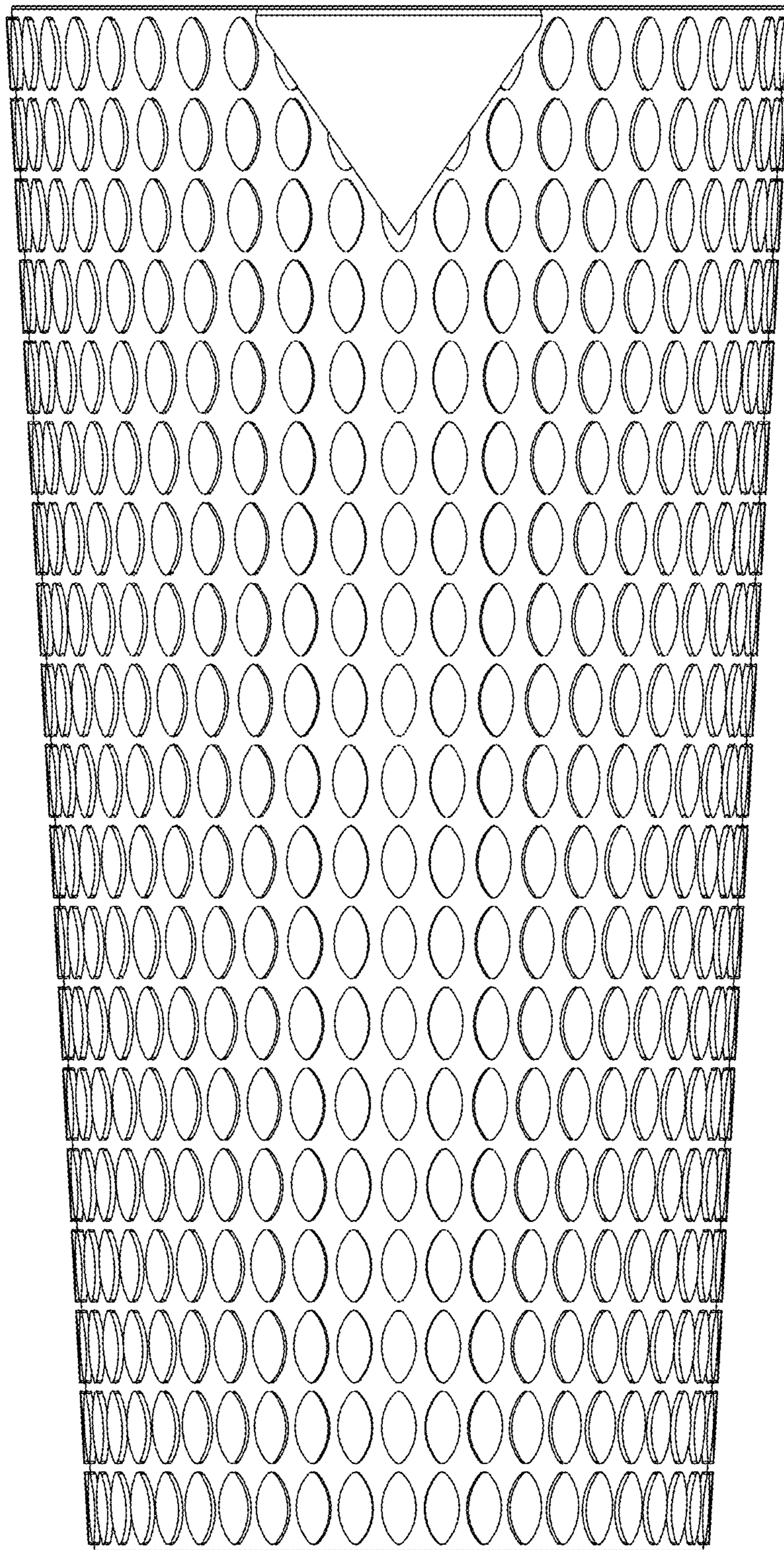

FIG. 5

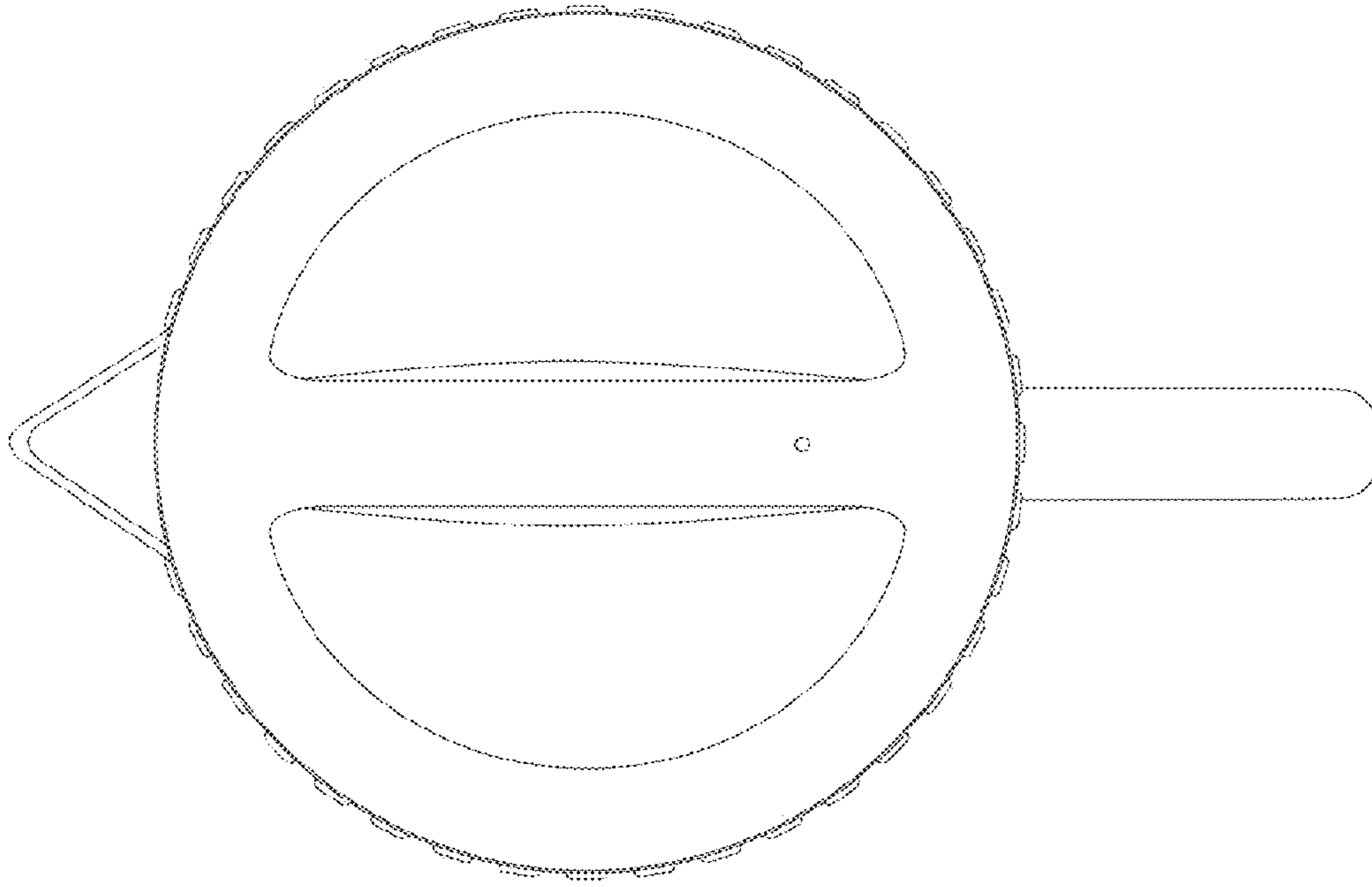

FIG. 6

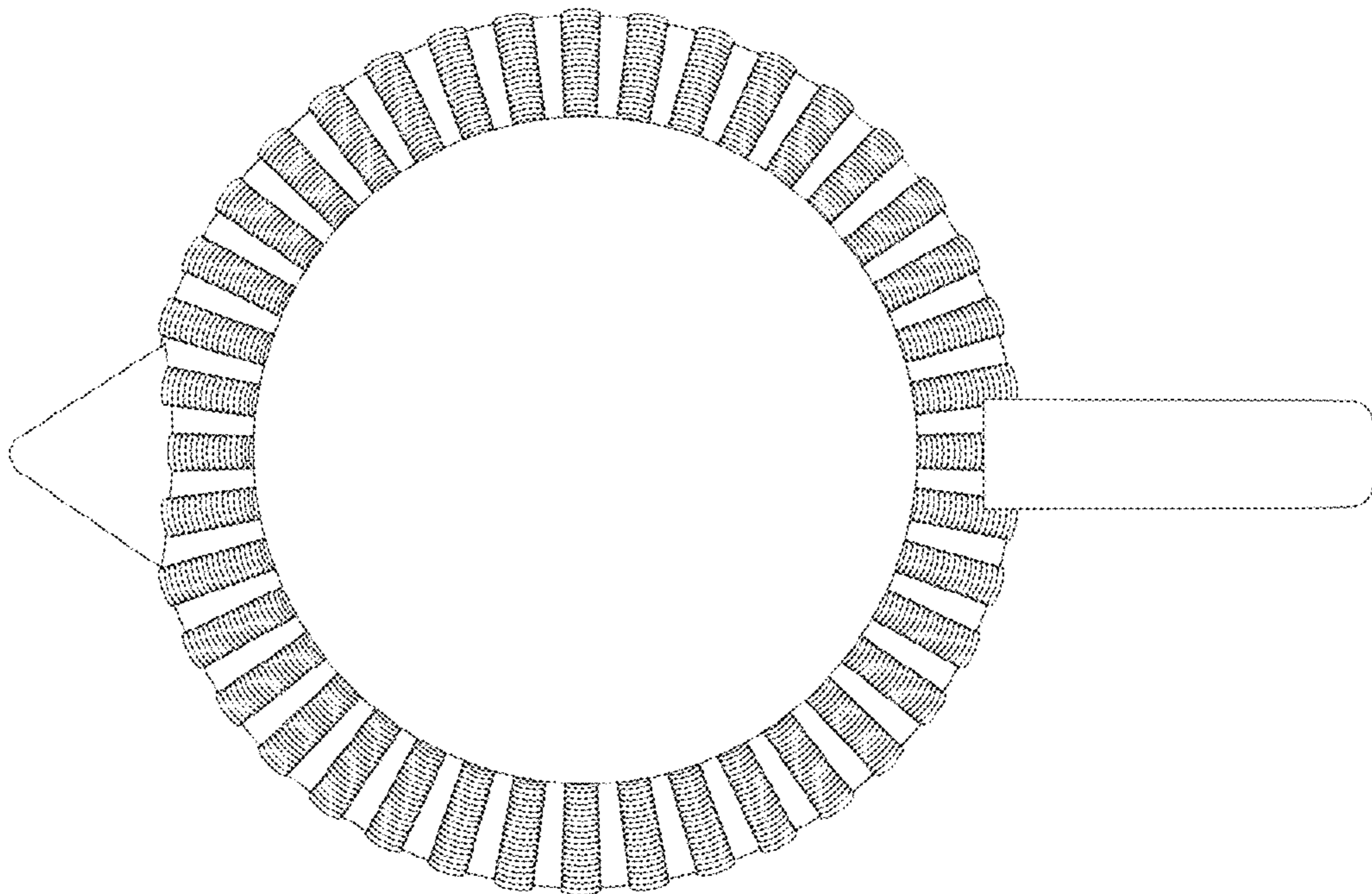

FIG. 7