

US00D769024S

(12) **United States Design Patent** (10) **Patent No.:** **US D769,024 S**
Montoya (45) **Date of Patent:** **** Oct. 18, 2016**

(54) **WALL MOUNTED HOLDER FOR A WALKING CANE**

(71) Applicant: **Ismael Montoya**, Atwater, CA (US)

(72) Inventor: **Ismael Montoya**, Atwater, CA (US)

(**) Term: **14 Years**

(21) Appl. No.: **29/526,419**

(22) Filed: **May 8, 2015**

(51) **LOC (10) Cl.** **03-03**

(52) **U.S. Cl.**
USPC **D6/567**

(58) **Field of Classification Search**
USPC D6/567, 327, 329, 552, 553; D8/354, D8/356, 371; D11/78.1; D19/65; D21/385, D21/662, 698; 211/13.1, 60.1, 64, 70.5, 211/86.01, 87.01, 88.01, 89.01, 181.1; 248/121, 175, 200, 302, 304, 309.1, 248/310, 311.2, 312, 560
CPC .. A47G 25/12; E01H 2001/1293; A45B 3/16
See application file for complete search history.

(56) **References Cited**

U.S. PATENT DOCUMENTS

4,300,742 A 11/1981 Hunn
D442,076 S * 5/2001 Swanson D8/373

D523,735 S * 6/2006 Craine D8/354
D546,610 S * 7/2007 Blanchard D6/567
D547,048 S * 7/2007 Conway D3/10
7,422,188 B1 9/2008 Schlosser
D667,249 S * 9/2012 London D6/553
2005/0098695 A1* 5/2005 Hollenbeck A61H 3/0244
248/229.26

* cited by examiner

Primary Examiner — Wan Laymon
Assistant Examiner — Mark Booker
(74) *Attorney, Agent, or Firm* — Corrsley & Stevenson
Intellectual Property Law

(57) **CLAIM**
The ornamental design for a wall mounted holder for a walking cane, as shown and described.

DESCRIPTION

FIG. 1 is a front elevation view of a wall mounted holder for a walking cane showing my new design;
FIG. 2 is a rear elevation view thereof;
FIG. 3 is a right side elevation view thereof, the opposite side being a mirror image of the shown;
FIG. 4 is a top plan view thereof;
FIG. 5 is a bottom plan view thereof; and,
FIG. 6 is an isometric view thereof.

1 Claim, 5 Drawing Sheets

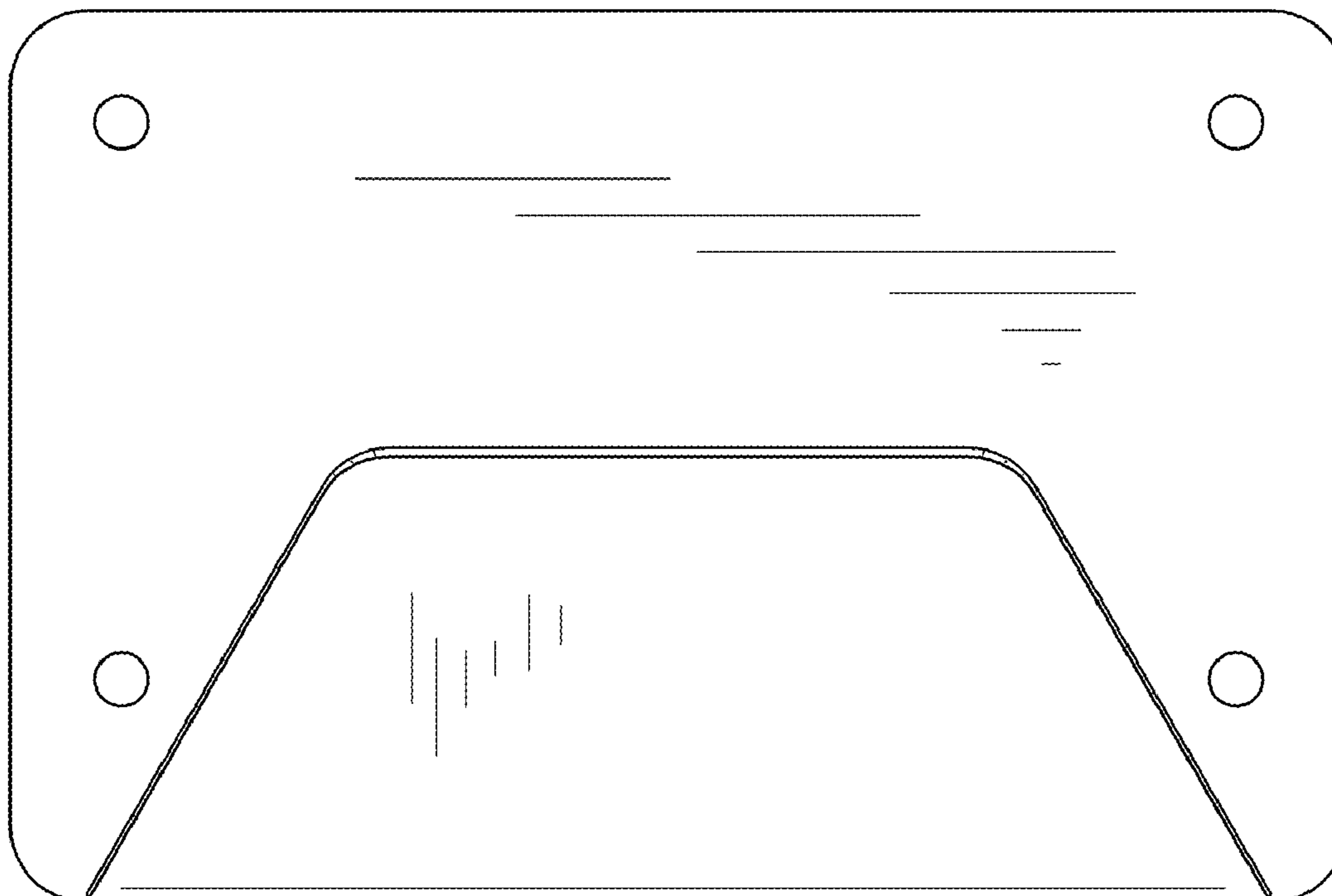

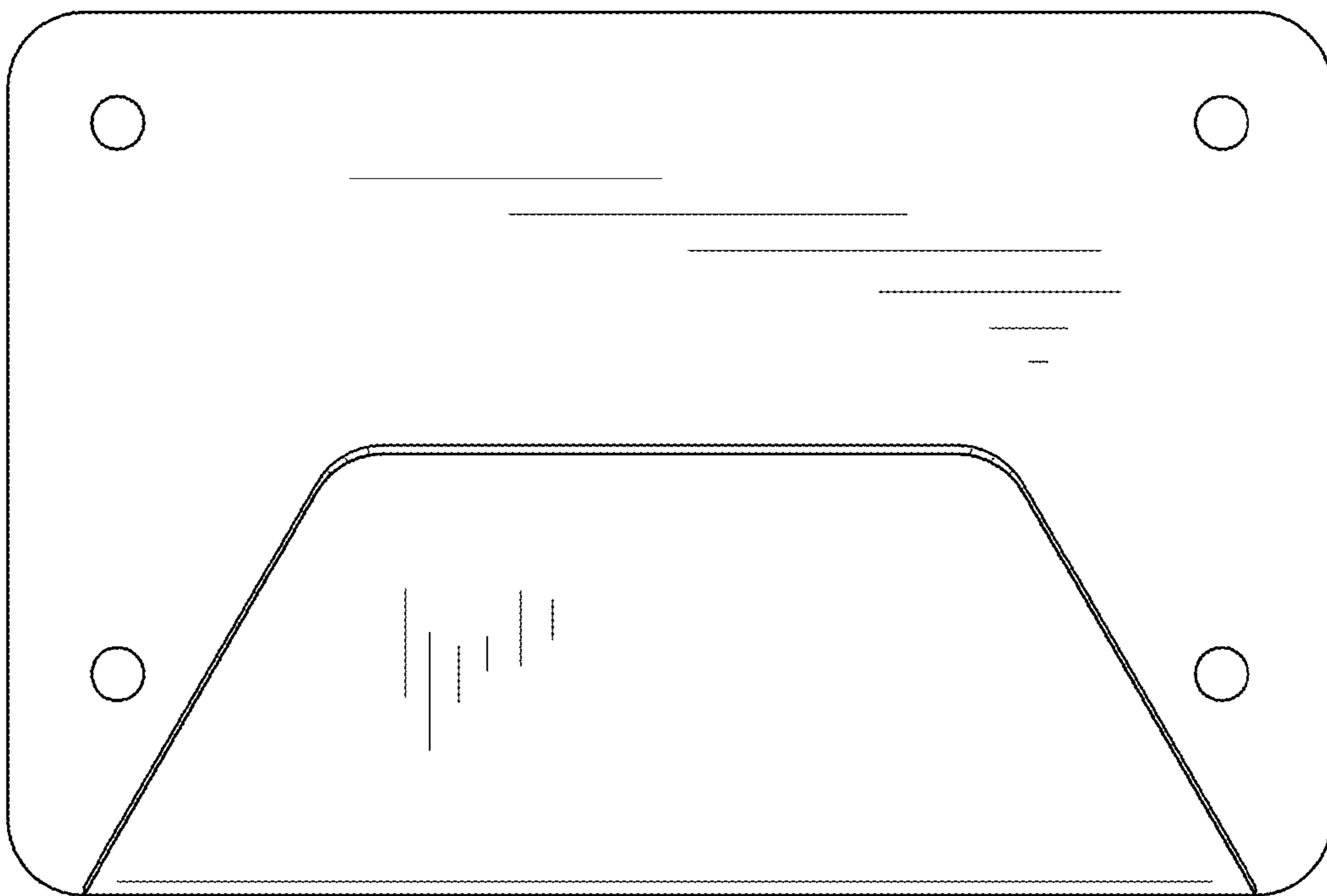

FIG. 1

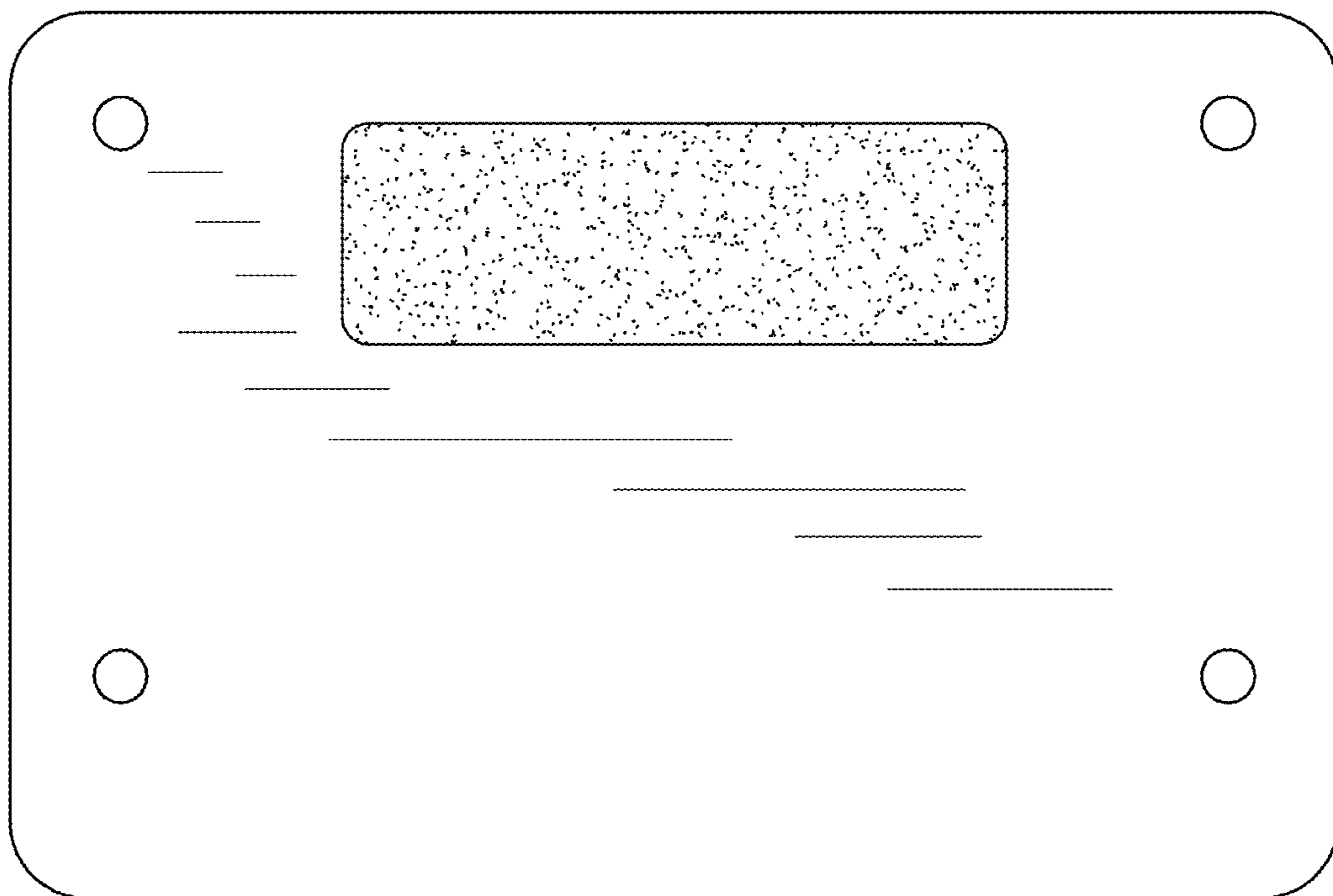

FIG. 2

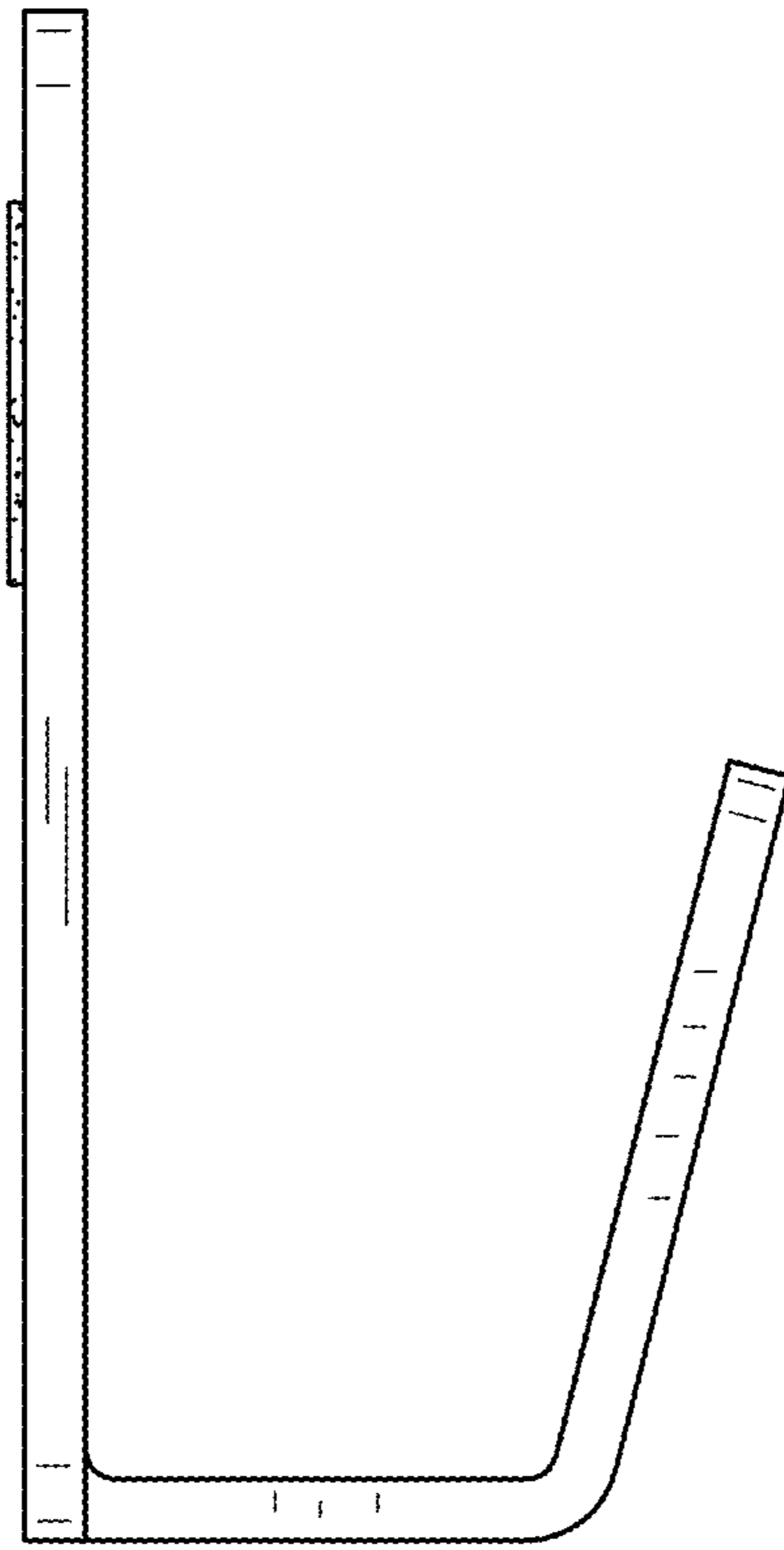

FIG. 3

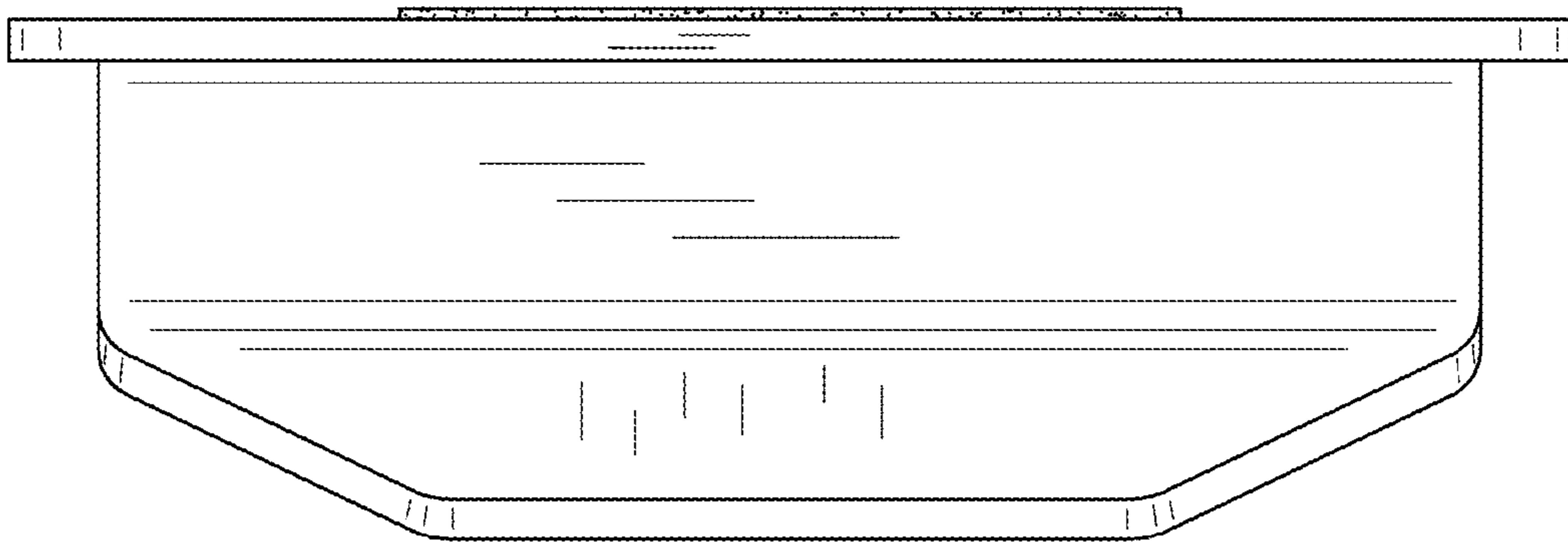

FIG. 4

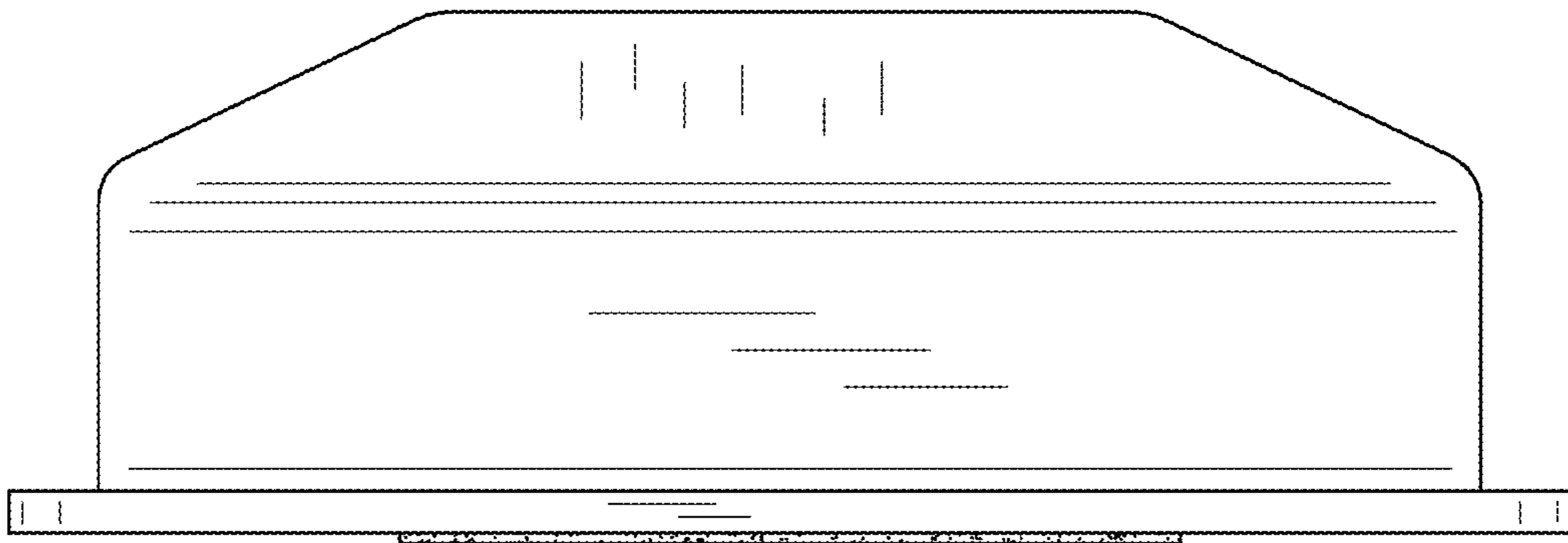

FIG. 5

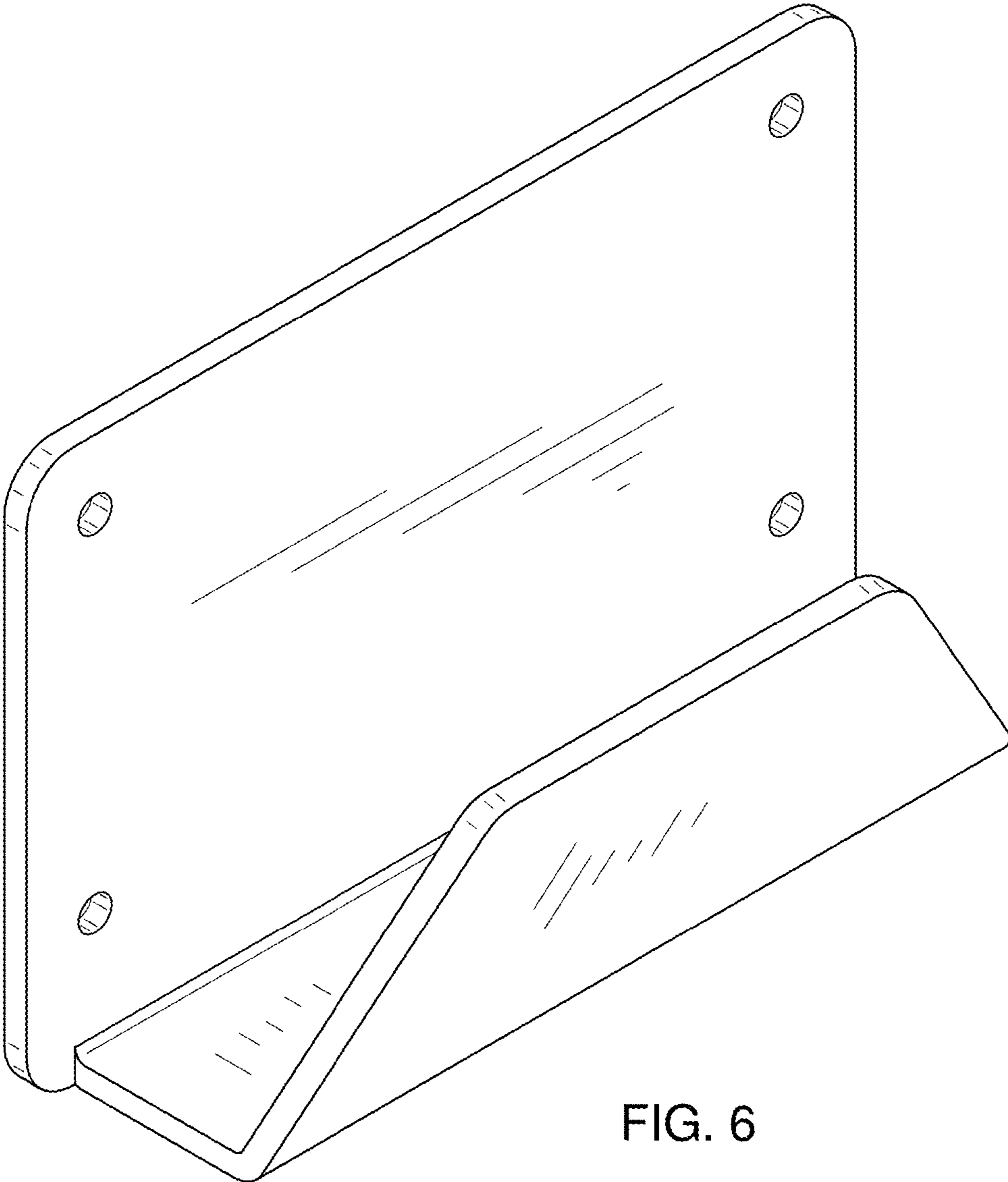

FIG. 6