



US00D768964S

(12) **United States Design Patent**
York

(10) **Patent No.:** **US D768,964 S**
(45) **Date of Patent:** **** *Oct. 18, 2016**

(54) **HEAD VISOR**

- (71) Applicant: **Foamula Products, Inc.**, Wellington, FL (US)
- (72) Inventor: **Daniel T. York**, N. Palm Beach, FL (US)
- (73) Assignee: **Foamula Products, Inc.**, Wellington, FL (US)
- (*) Notice: This patent is subject to a terminal disclaimer.
- (**) Term: **14 Years**
- (21) Appl. No.: **29/514,269**
- (22) Filed: **Jan. 9, 2015**

Related U.S. Application Data

- (60) Continuation-in-part of application No. 14/279,994, filed on May 16, 2014, now Pat. No. 9,215,902, which is a division of application No. 13/690,881, filed on Nov. 30, 2012, now Pat. No. 8,763,163, application No. 29/514,269, which is a continuation-in-part of application No. 29/477,813, filed on Dec. 27, 2013, now Pat. No. Des. 749,303.

(51) **LOC (10) Cl.** **02-03**

(52) **U.S. Cl.**
USPC **D2/872**

(58) **Field of Classification Search**

USPC D2/865, 866, 867, 868, 869, 870, 871, D2/872, 873, 874, 875, 876, 878, 879, 881, D2/882, 883, 884, 889, 890, 891, 892, 893, D2/894, 895; 2/195.6, 209.13, 10, 12, 171, 2/181, 422, 410, 425, 15, 431, 453, 454, 2/175.6, 195.1, 411
CPC A42B 1/062; A42B 1/063; A42B 1/064; A42B 3/222; A42B 3/226; A42B 3/227
See application file for complete search history.

(56) **References Cited**

U.S. PATENT DOCUMENTS

104,652 A 6/1870 Scribner
729,500 A * 5/1903 Mahony G02C 7/16
2/12

(Continued)

FOREIGN PATENT DOCUMENTS

JP 2010229609 10/2010

OTHER PUBLICATIONS

Vizers hats designed specially for attractions (on-line), dated Feb. 15, 2013. Retrieved from Internet May 15, 2015, URL: <http://www.attractionsmanagement.com/detail.cfm?Pagetype=detail&subject=product&codeID=304390> (1 page).*

(Continued)

Primary Examiner — Barbara Fox

Assistant Examiner — Kimberly Barnes

(74) *Attorney, Agent, or Firm* — Brian S. Steinberger; Law Offices of Brian S. Steinberger, P.A.

(57) **CLAIM**

The ornamental design for a head visor, as shown and described.

DESCRIPTION

FIG. 1 is an upper front right perspective view of the head visor.

FIG. 2 is an upper left rear perspective view of the head visor of FIG. 1.

FIG. 3 is a lower rear right perspective view of the head visor of FIG. 1.

FIG. 4 is a lower front left perspective view of the head visor of FIG. 1.

FIG. 5 is a lower perspective exploded view of the head visor of FIG. 1.

FIG. 6 is a front elevation view of the head visor of FIG. 1.

FIG. 7 is a rear elevation view of the head visor of FIG. 1.

FIG. 8 is a left side elevation view of the head visor of FIG. 1.

FIG. 9 is a right side elevation view of the head visor of FIG. 1.

FIG. 10 is a top plan view of the head visor of FIG. 1; and, FIG. 11 is a bottom plan view of the head visor of FIG. 1.

1 Claim, 6 Drawing Sheets

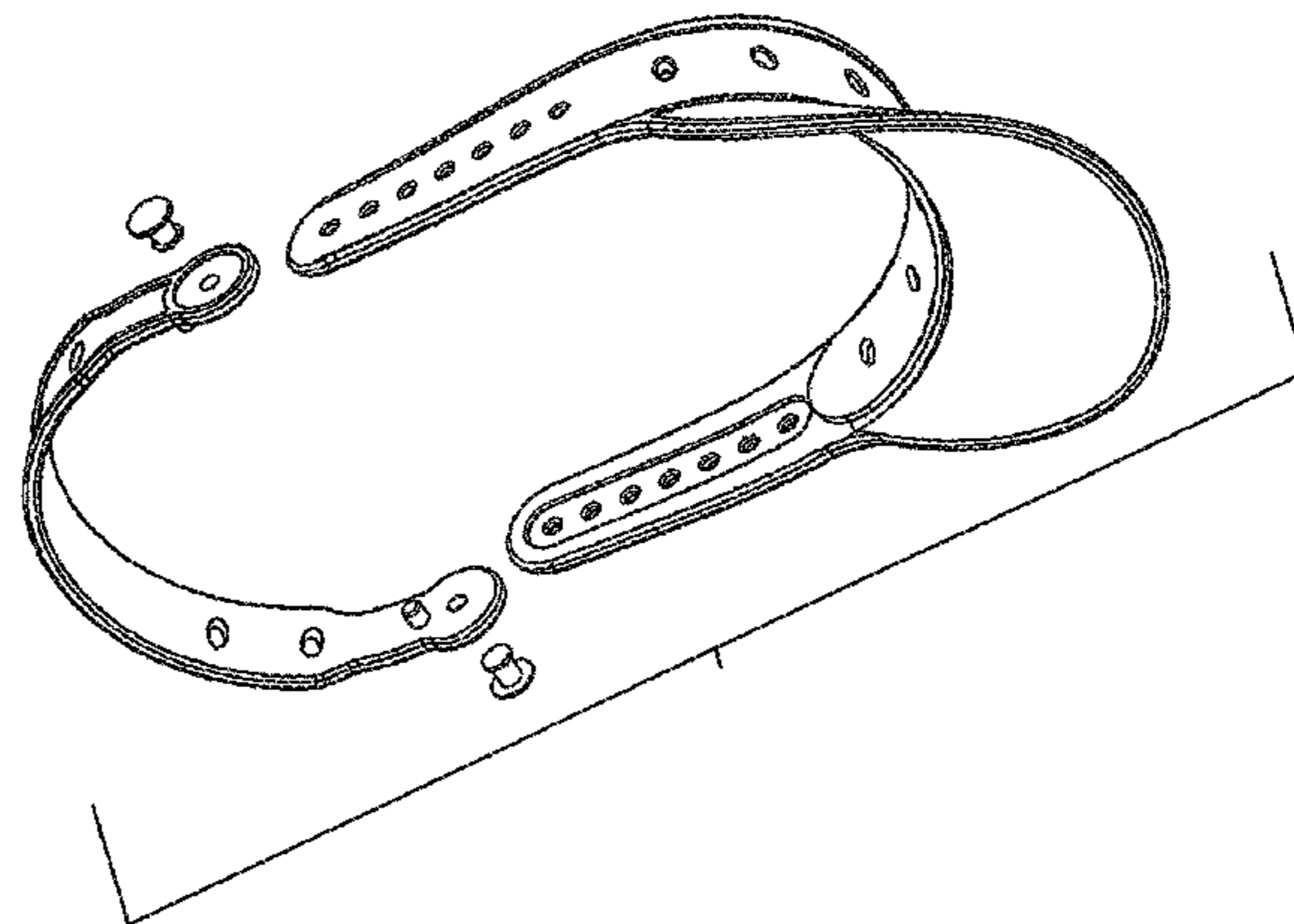
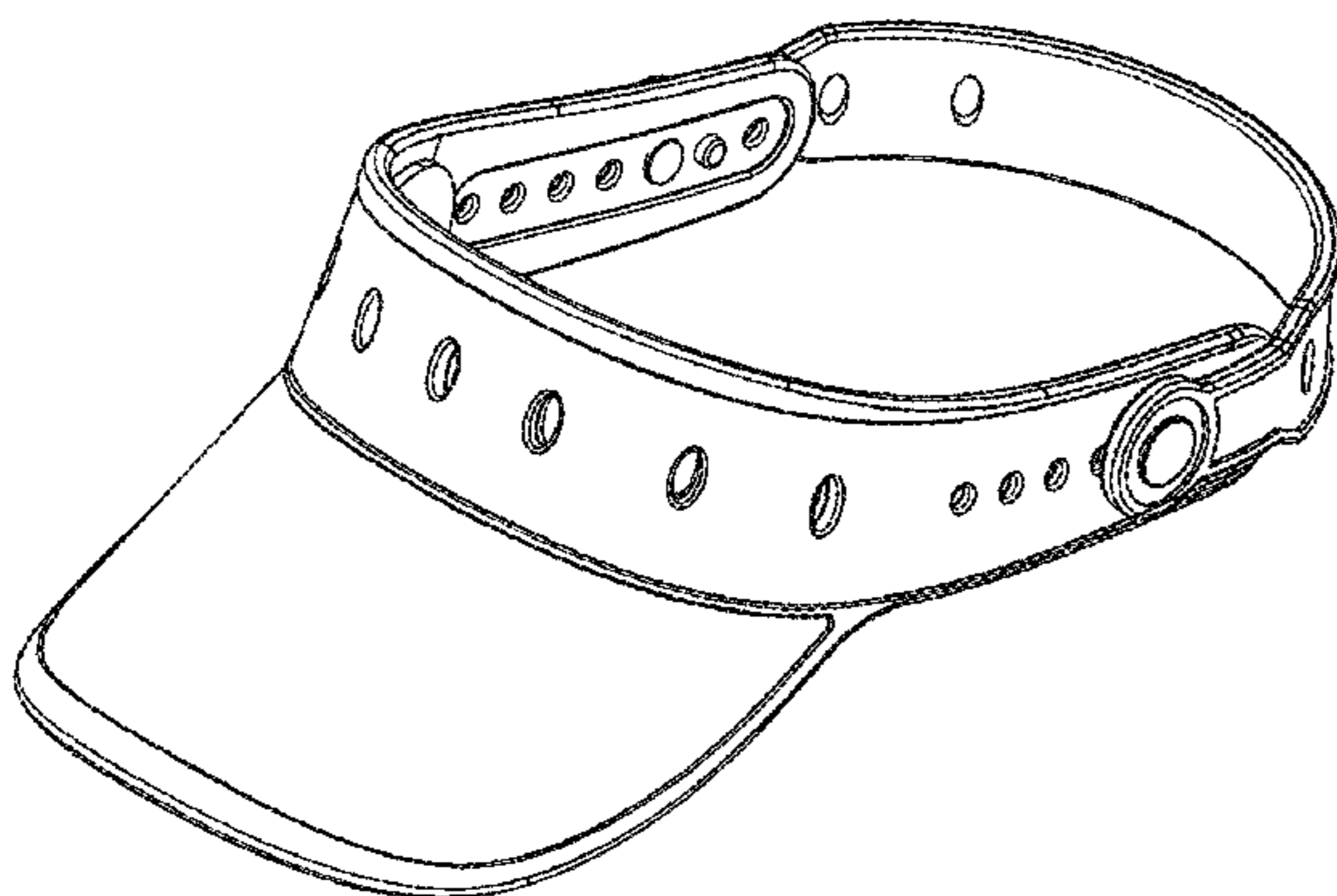

US D768,964 S

(56)

References Cited

U.S. PATENT DOCUMENTS

757,854 A *	4/1904	Wickersham	G02C 7/16 2/12	5,983,400 A	11/1999	Kronenberger
1,190,427 A	7/1916	Kromer		6,012,203 A	1/2000	Baron Pearson
1,435,533 A *	11/1922	Knackstedt	G02C 5/124 2/12	6,038,702 A	3/2000	Knerr
1,452,305 A *	4/1923	Mahony	A61F 9/045 2/12	6,038,704 A	3/2000	Crescentini
1,506,815 A	12/1923	Cormay		6,044,495 A	4/2000	Ellman
1,624,727 A	1/1927	Goldberg		6,158,054 A	12/2000	Perry, Sr.
1,782,206 A	3/1928	Kornsweet		6,161,224 A	12/2000	Tuetken
2,160,513 A	1/1937	Pasternak		6,175,963 B1	1/2001	Loeffelholz
2,406,598 A *	8/1946	Flood	A61F 9/025 2/12	6,237,159 B1	5/2001	Martin
2,748,517 A	9/1953	Berkis		6,256,794 B1	7/2001	Erickson
2,908,012 A	10/1959	Feldman		6,279,167 B1	8/2001	Johnson
2,968,812 A *	1/1961	Vivolo	A61F 9/045 2/12	6,305,028 B1	10/2001	Lin
3,484,974 A	12/1969	Culmone		6,317,896 B1	11/2001	Timms
3,491,374 A *	1/1970	Frangos	A42B 3/28 2/171.3	6,341,380 B1	1/2002	Coleman
3,551,911 A	1/1971	Holden		6,349,415 B1	2/2002	Gong
3,849,839 A	11/1974	Zimber		D457,298 S	5/2002	Rowland
4,168,542 A	9/1979	Small		6,381,754 B1	5/2002	Ezenekwe
4,292,689 A	10/1981	Townsend, Jr.		6,389,608 B1	5/2002	Williams
D266,712 S	11/1982	Van Valkenburgh		D460,604 S	7/2002	Sullivan, Jr.
4,507,344 A	3/1985	Baughman		6,412,151 B1	7/2002	Rowland
4,551,860 A	11/1985	Smit		6,460,193 B1	10/2002	DiPalma
D282,308 S	1/1986	Kain		6,513,167 B1	2/2003	Cheng
4,611,355 A	9/1986	Galanto		6,519,779 B1	2/2003	Taguchi
4,612,672 A	9/1986	Schrack		6,675,512 B1	1/2004	Shwartz
4,736,469 A	4/1988	Boretti		6,718,559 B1	4/2004	Davidson
4,776,043 A	10/1988	Coleman		6,769,139 B1	8/2004	Goldkind
4,837,960 A	6/1989	Skaja		6,802,140 B2	10/2004	Aslanides
4,845,786 A	7/1989	Chiarella		D501,705 S *	2/2005	Hathaway D2/869
4,873,726 A	10/1989	Tapia		6,993,858 B2 *	2/2006	Seamans A43B 1/0081 36/11.5
4,918,758 A	4/1990	Rendina		D517,789 S *	3/2006	Seamans D2/969
5,003,640 A	4/1991	Pizzacar		7,089,691 B1	8/2006	Silvera
5,070,545 A	12/1991	Tapia		D530,486 S	10/2006	Ruttan
5,117,506 A	6/1992	Byrnes		7,178,364 B2	2/2007	Shapiro
5,136,726 A	8/1992	Kellin		7,182,478 B2	2/2007	Marston
5,142,706 A	9/1992	Layhon		7,200,959 B2	4/2007	Spann
5,276,985 A	1/1994	Halloran		D543,014 S	5/2007	Sharpe
5,282,278 A	2/1994	Miner		D545,032 S *	6/2007	Wolf D2/923
D345,447 S *	3/1994	Lapsker	D2/876	D545,033 S *	6/2007	Wolf D2/926
5,328,399 A	7/1994	Reynolds		7,243,377 B2	7/2007	Ashy
5,359,734 A	11/1994	Rathburn		D558,955 S	1/2008	Taylor
5,410,761 A	5/1995	Connelly		D566,904 S *	4/2008	Verhaeghe D29/122
5,418,981 A	5/1995	Miner		D567,483 S *	4/2008	Liow D2/896
5,428,842 A	7/1995	Wise		7,350,274 B2	4/2008	Rogers
5,437,064 A	8/1995	Hamaguchi		D571,082 S *	6/2008	Kelleghan D2/872
5,442,817 A	8/1995	Miner		7,389,567 B2	6/2008	Rogers
5,452,479 A	9/1995	Mostert		D579,606 S	10/2008	Scholl
5,477,629 A	12/1995	Gleason, Jr.		D592,835 S *	5/2009	Wilson D2/893
5,509,144 A	4/1996	Soergel		D593,285 S	6/2009	Olivo
5,510,961 A *	4/1996	Peng	A42B 1/242 2/209.12	D601,329 S	10/2009	Johns
5,647,060 A	7/1997	Lee		D603,584 S *	11/2009	Porter D2/865
5,673,501 A	10/1997	Mathews		D604,484 S *	11/2009	Lauro D2/946
5,713,083 A	2/1998	King		D606,288 S	12/2009	Thorne
5,718,559 A	2/1998	Freund		7,640,636 B2	1/2010	Clark
5,734,991 A	4/1998	Schmid		7,698,836 B2	4/2010	Schmelzer
5,742,944 A	4/1998	Pfefferman		D618,128 S	6/2010	Clark
D394,136 S	5/1998	Richlin		D619,336 S	7/2010	Eyl
5,754,983 A	5/1998	Landers		D620,235 S	7/2010	Kronenberger
5,773,118 A	6/1998	Eisenpresser		7,765,618 B2	8/2010	Egglesfield
5,790,988 A	8/1998	Guadagnino		D625,052 S	10/2010	Mastoras
5,794,267 A	8/1998	Wallace		7,891,117 B2 *	2/2011	Sack A43B 3/0078 36/1
5,803,266 A	9/1998	Blackwelder		8,001,661 B2	8/2011	Clark
5,826,278 A	10/1998	King		8,011,206 B2	9/2011	Imai
5,839,211 A	11/1998	Pallera		8,069,538 B2	12/2011	Wilcox
5,845,334 A	12/1998	Marcolini		D654,052 S	2/2012	Lee
5,887,287 A	3/1999	Potochnik		8,112,963 B2	2/2012	Johnson
D410,134 S	5/1999	Wolken		8,122,519 B2	2/2012	Schmelzer
5,901,370 A	5/1999	Linday		D672,535 S	12/2012	Phan
5,901,381 A	5/1999	Nelson		8,443,971 B1	5/2013	Green
				8,453,267 B1	6/2013	Stanley
				8,617,683 B2	12/2013	Johnson
				8,627,516 B2	1/2014	Evans
				8,763,163 B1	7/2014	Johns
				9,215,902 B2	12/2015	Johns
				2002/0118533 A1 *	8/2002	Marston A42B 1/242 362/106
				2004/0019953 A1	2/2004	Galimant
				2004/0034903 A1	2/2004	Blair

(56)

References Cited

U.S. PATENT DOCUMENTS

2004/0093658	A1	5/2004	Jackson	
2004/0117894	A1	6/2004	Kuo	
2005/0198725	A1	9/2005	Mollo	
2005/0273906	A1	12/2005	Kim	
2006/0007668	A1	1/2006	Chien	
2006/0152671	A1	7/2006	Risso	
2007/0006502	A1	1/2007	Schmelzer	
2007/0084019	A1	4/2007	Wilcox	
2008/0060110	A1	3/2008	Schmelzer	
2008/0141440	A1	6/2008	Taylor	
2008/0263839	A1*	10/2008	Stillwell A42B 1/248 24/713.6
2009/0025113	A1*	1/2009	Kelleghan A42B 1/24 2/12
2009/0101162	A1*	4/2009	Hsu A45D 8/36 132/273
2010/0064419	A1	3/2010	Lee	
2010/0229609	A1	9/2010	Bergmann	
2011/0078843	A1	4/2011	Kennedy	
2011/0094015	A1	4/2011	Braun	
2012/0304691	A1	12/2012	Braun	
2013/0318688	A1	12/2013	Cherin	
2014/0137311	A1*	5/2014	Sandoval A42B 1/063 2/181

OTHER PUBLICATIONS

Logo Mark by Viziers Group, LLC (on-line), trademark registration filed Jan. 22, 2014. Retrieved from Internet May 15, 2015, URL: <http://www.trademarkia.com/logo-86171739.html> (3 pages).*

Viziers At Surf Expo (on-line), posted on Facebook Sep. 13, 2013. Retrieved from Internet Aug. 11, 2015, URL: <https://www.facebook.com/myvizer/photos/pb.608478422509824.-2207520000.1439302702./647962368561429/?type=3&theatre> (1 page).*

Viziers Soft—Colorful—Comfortable . . . and they Float! (on-line), dated Mar. 15, 2012. Retrieved from Internet May 15, 2015, URL: <https://web.archive.org/web/20120315105657/http://www.viziers.com/> (1 page).*

Viziers Group, LLC, International Search Report mailed Feb. 24, 2014 for serial No. PCT/US2013/069220 filed on Nov. 8, 2013, 13 pages.

Viziers Group, LLC, PCT Application No. PCT/US2013/069220 filed Nov. 8, 2013, Notification Concerning Transmittal of International Preliminary Report on Patentability mailed Jun. 11, 2015, 10 pages.

* cited by examiner

FIG. 1

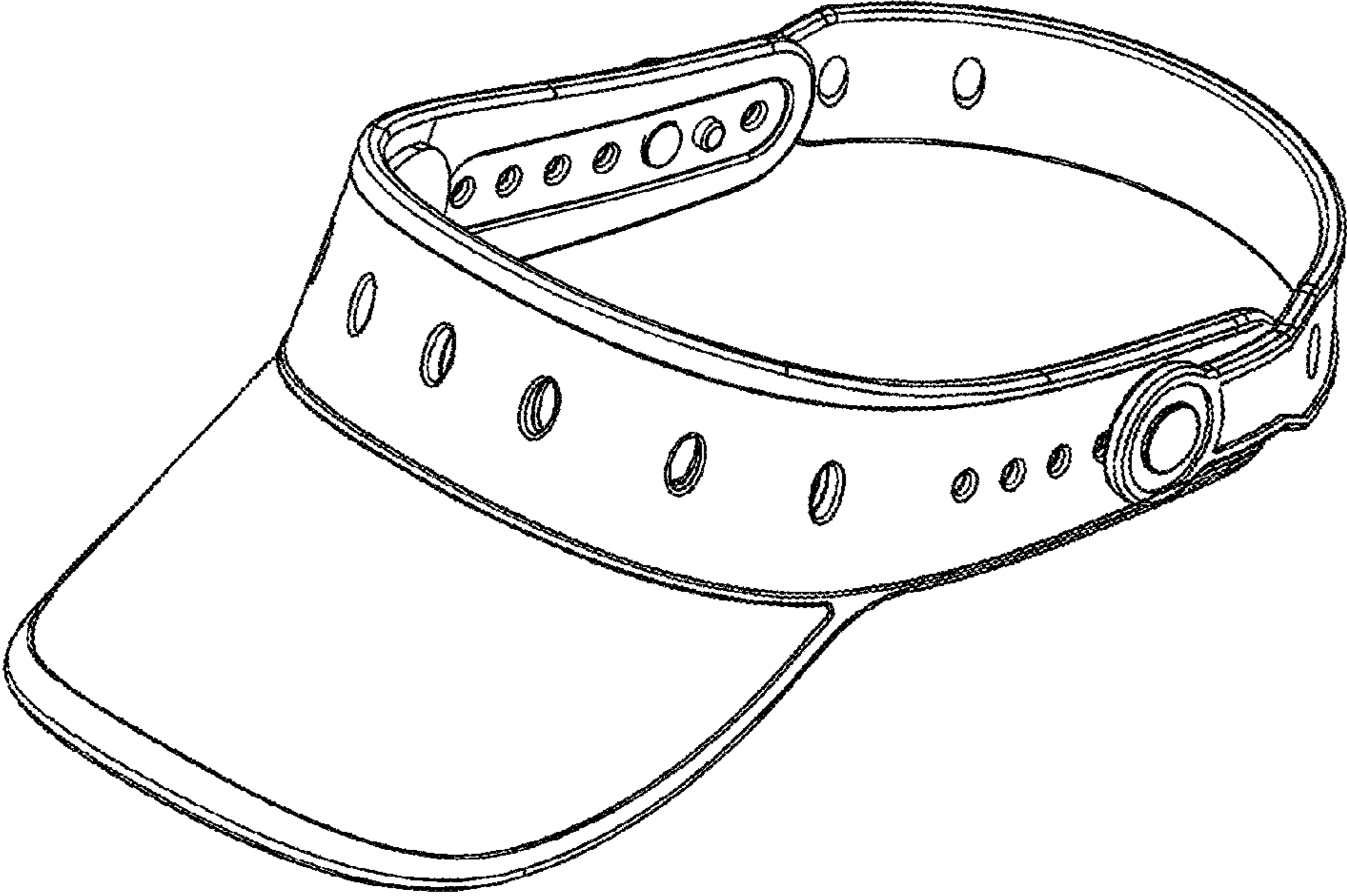

FIG. 2

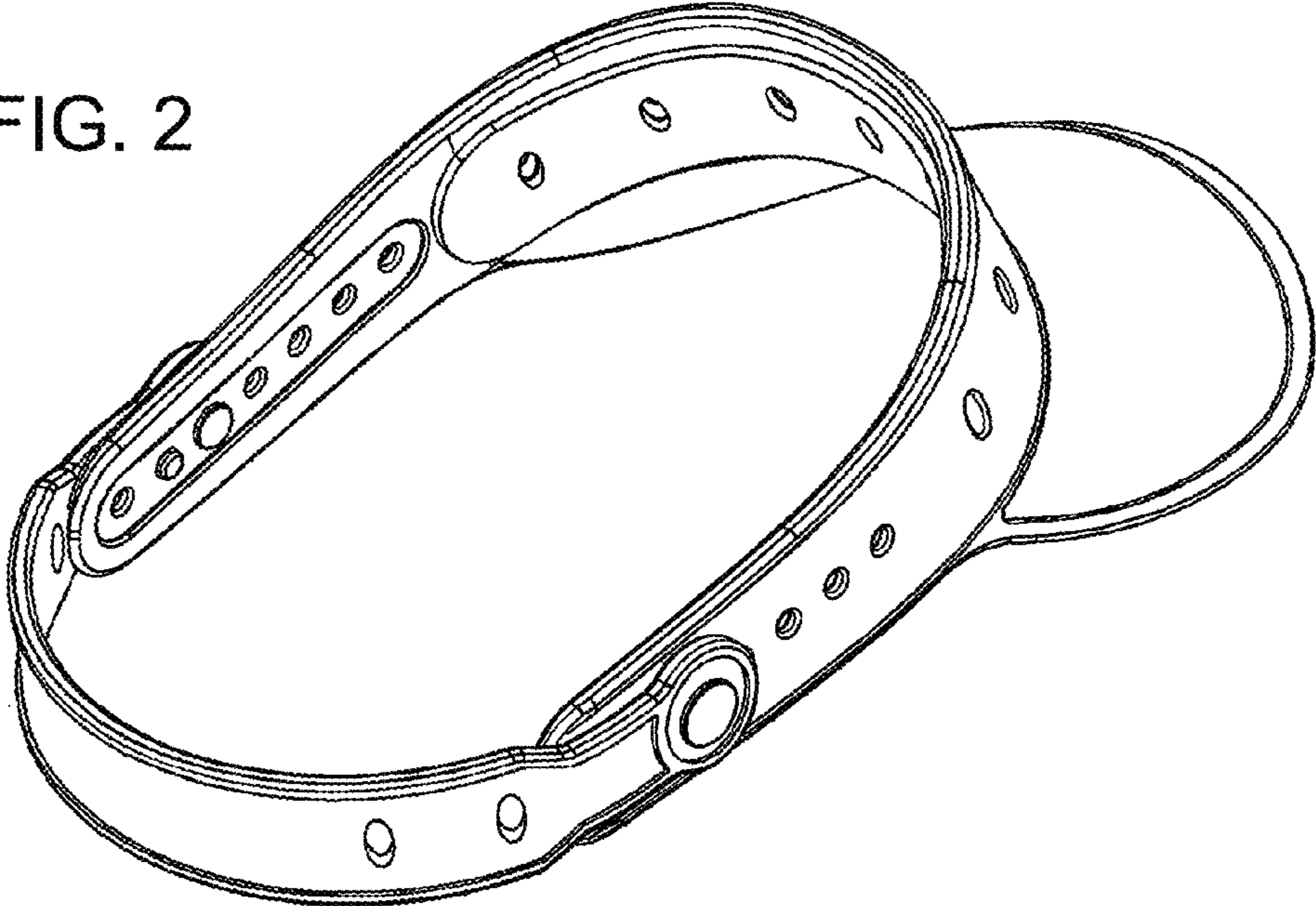

FIG. 3

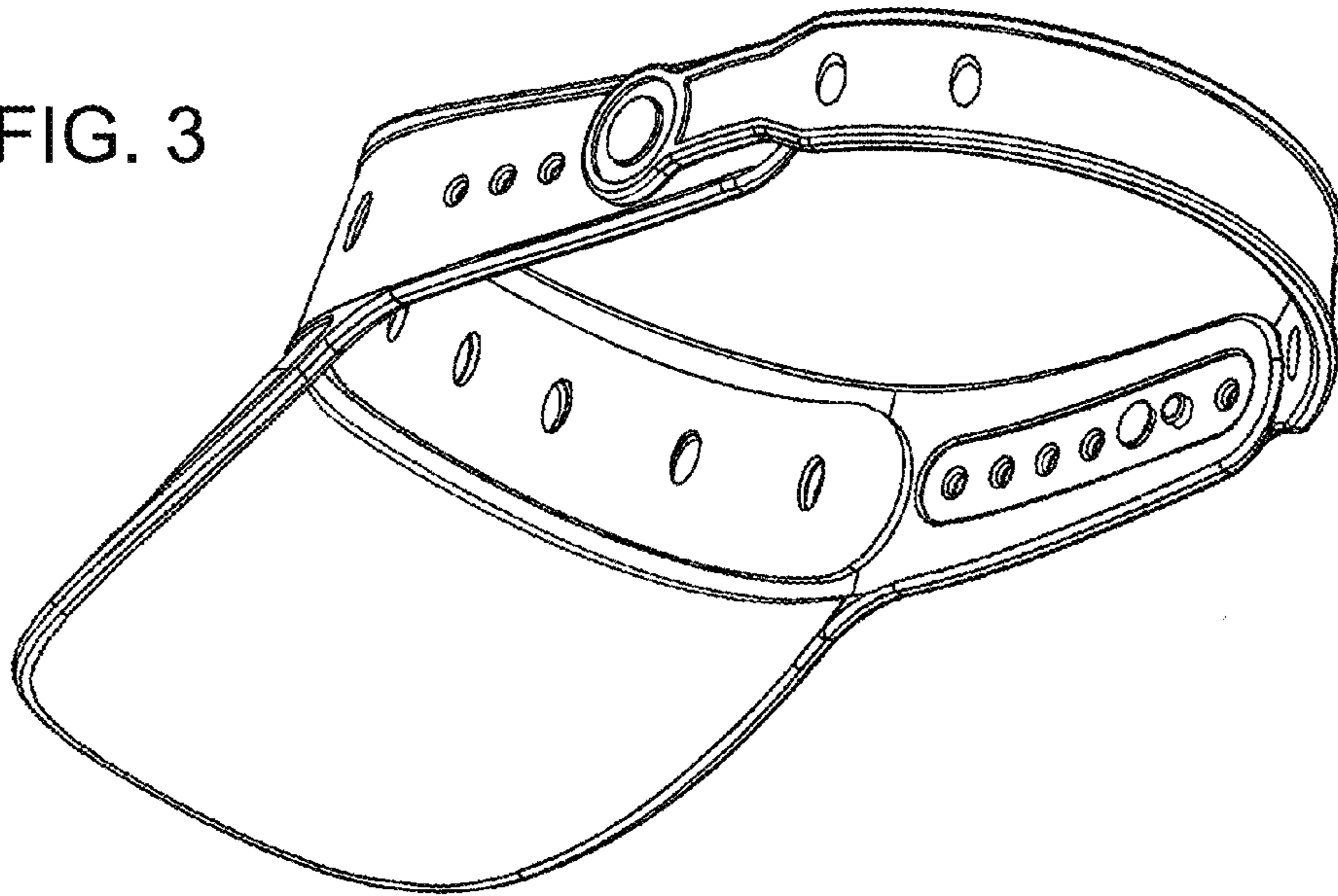

FIG. 4

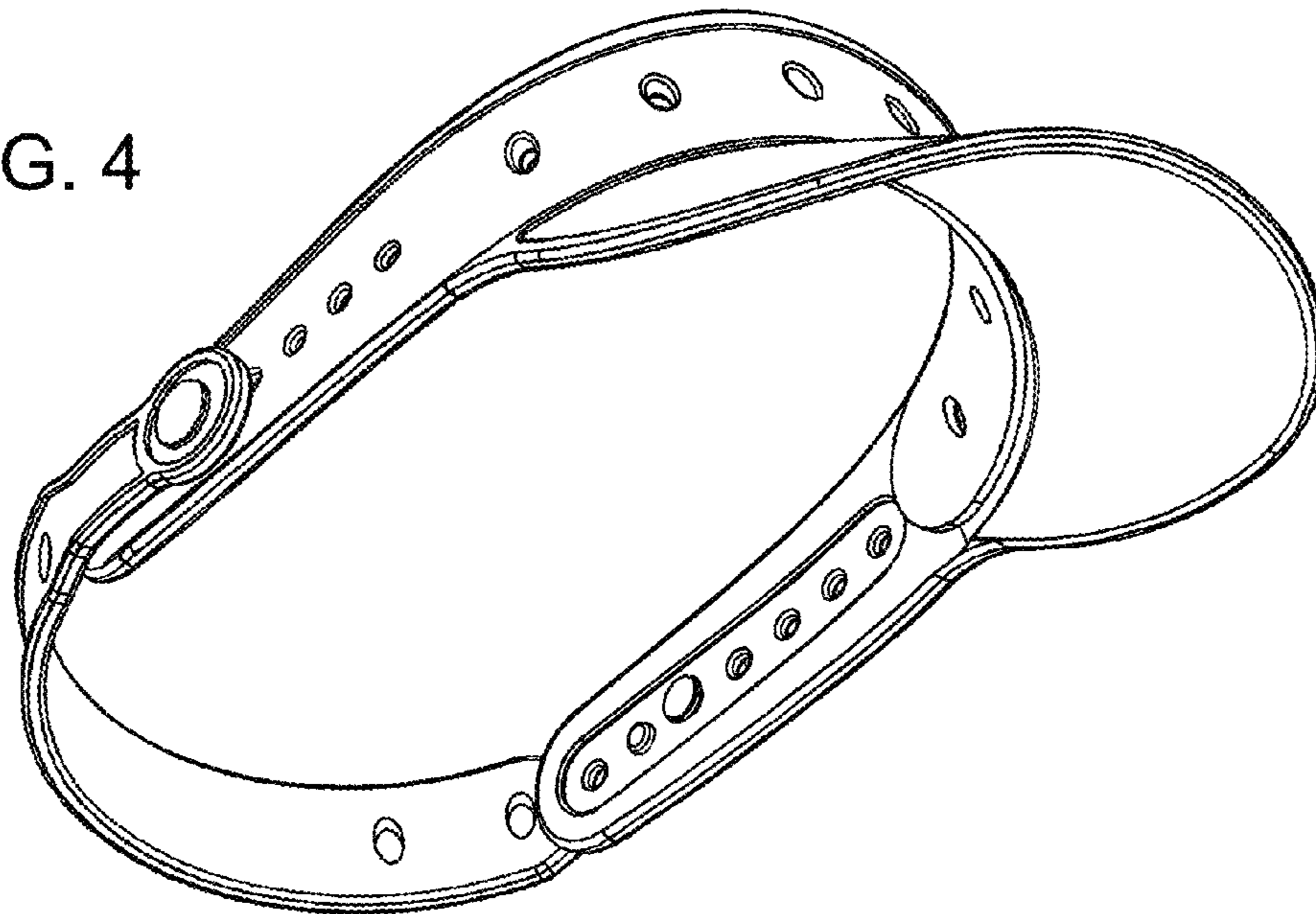

FIG. 5

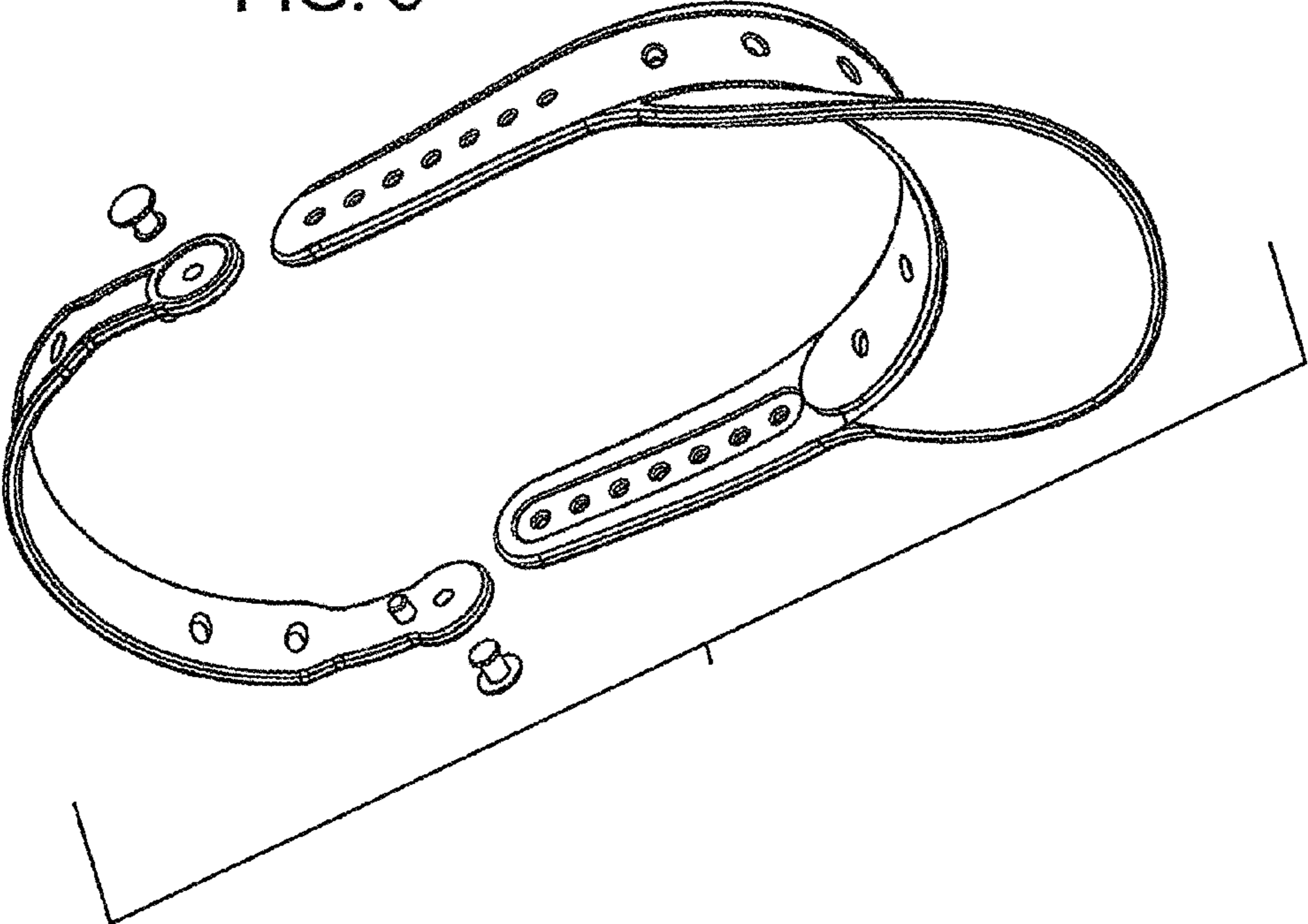

FIG. 6

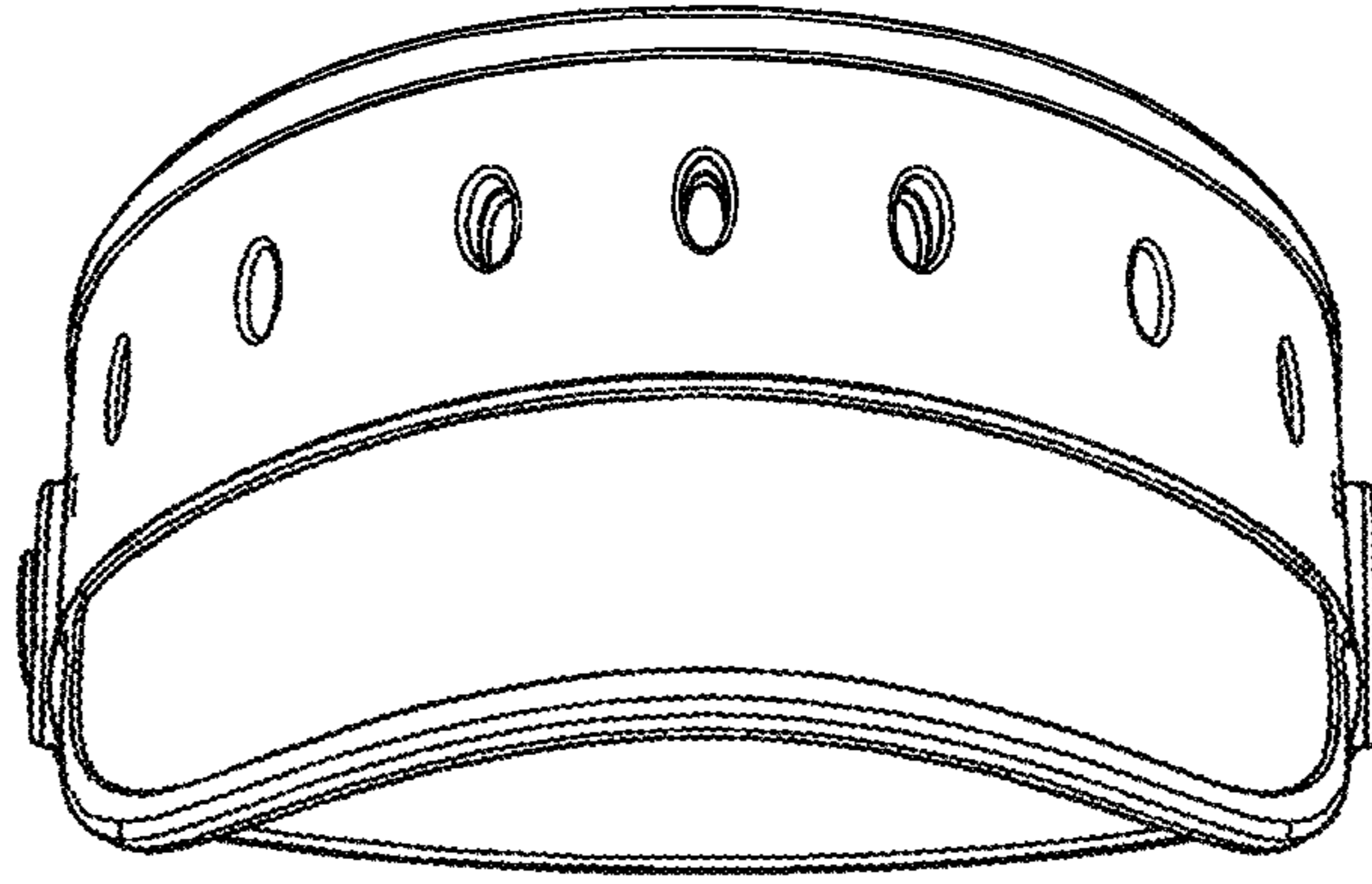

FIG. 7

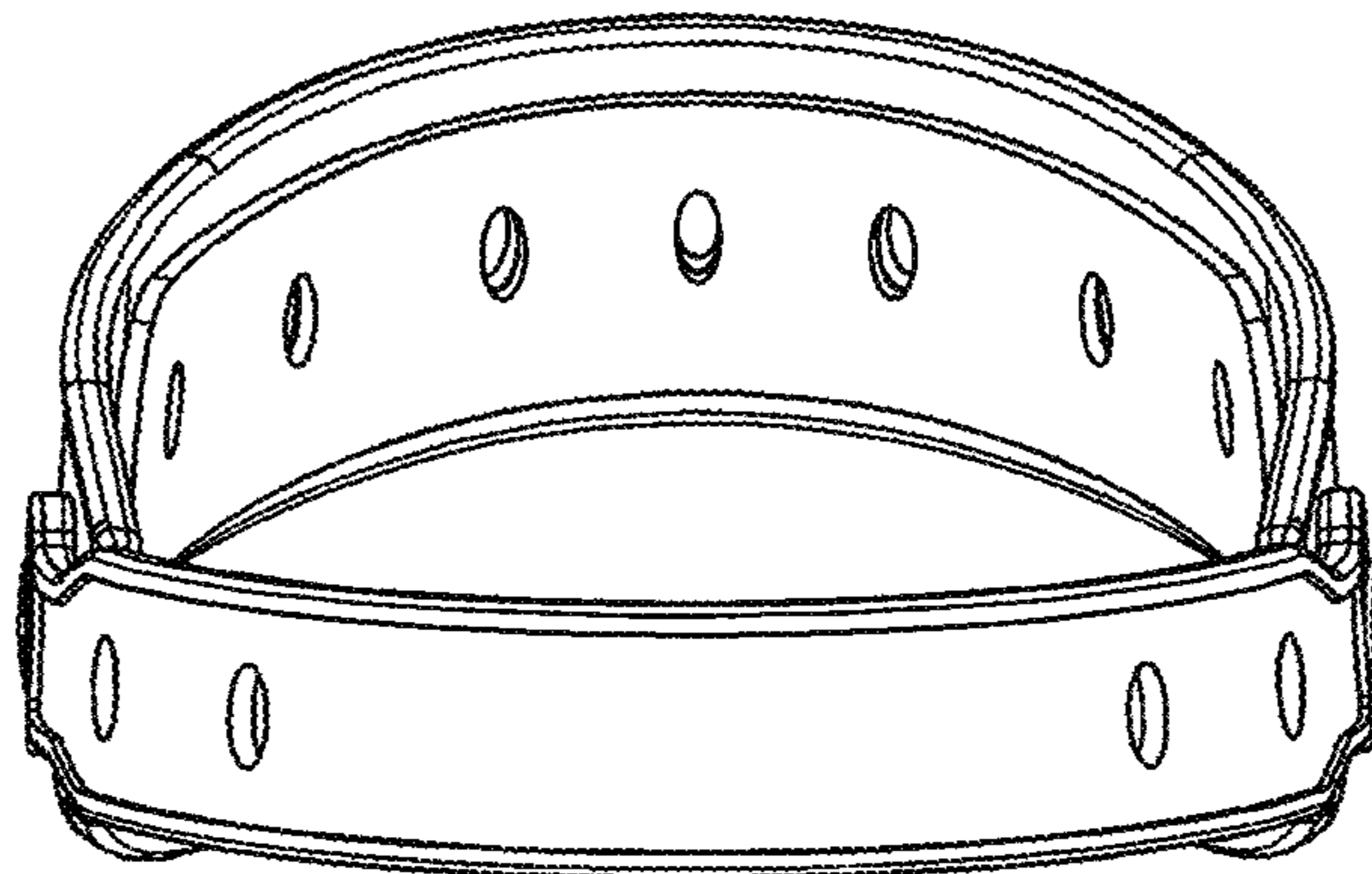

FIG. 8

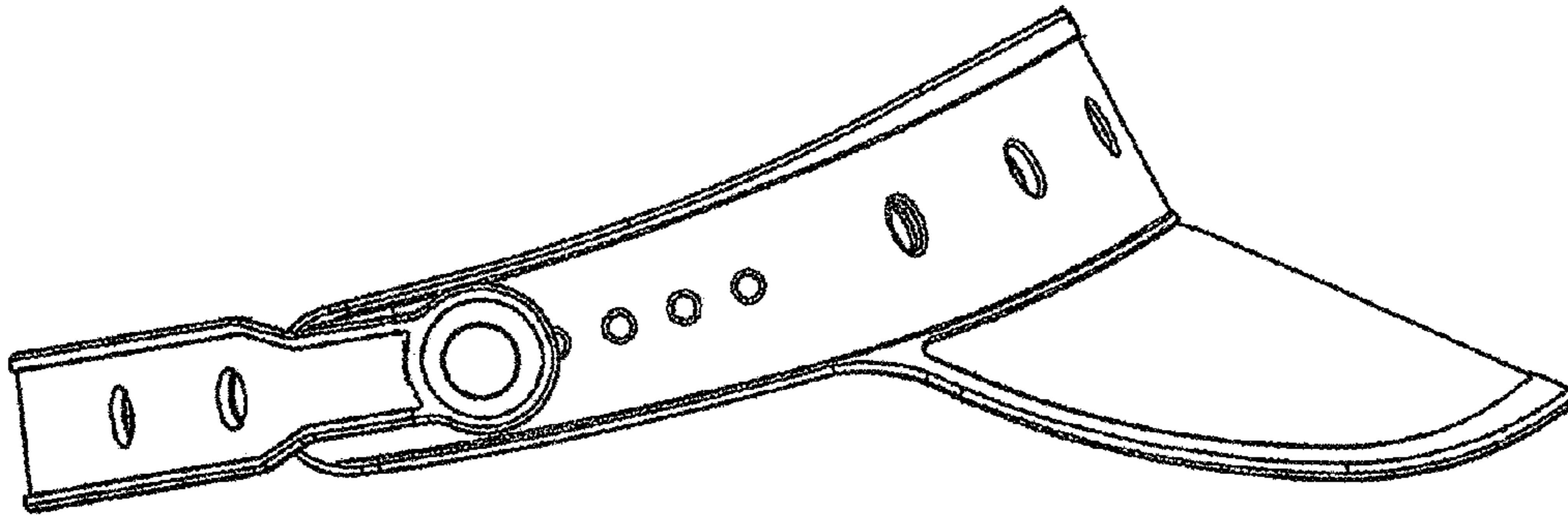

FIG. 9

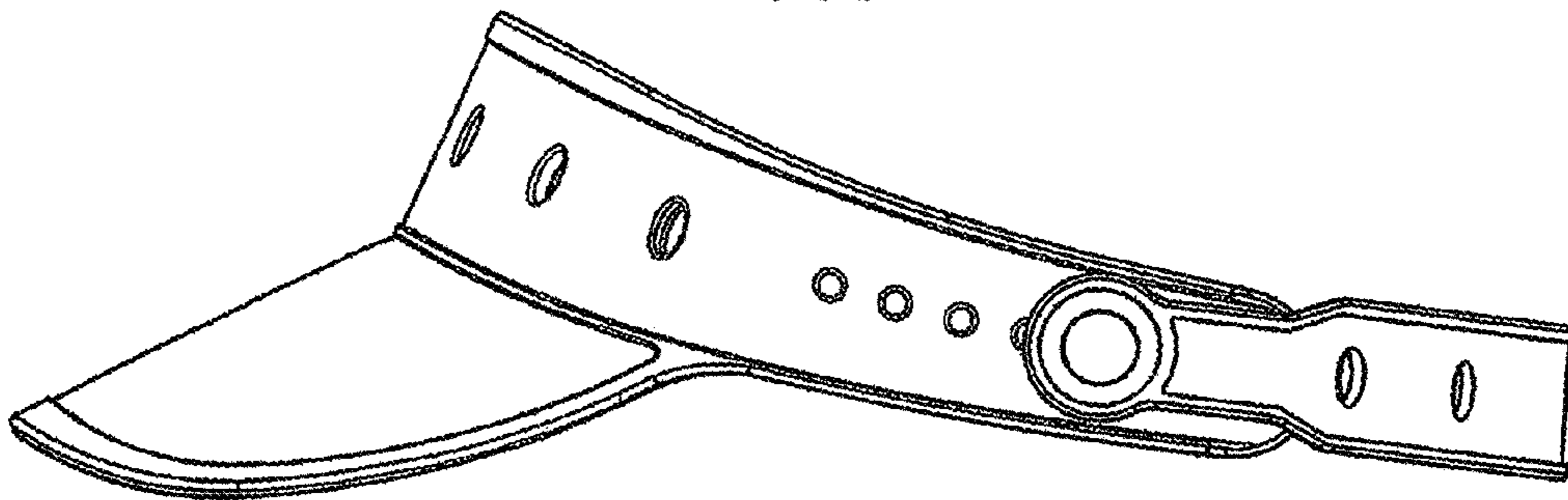

FIG. 10

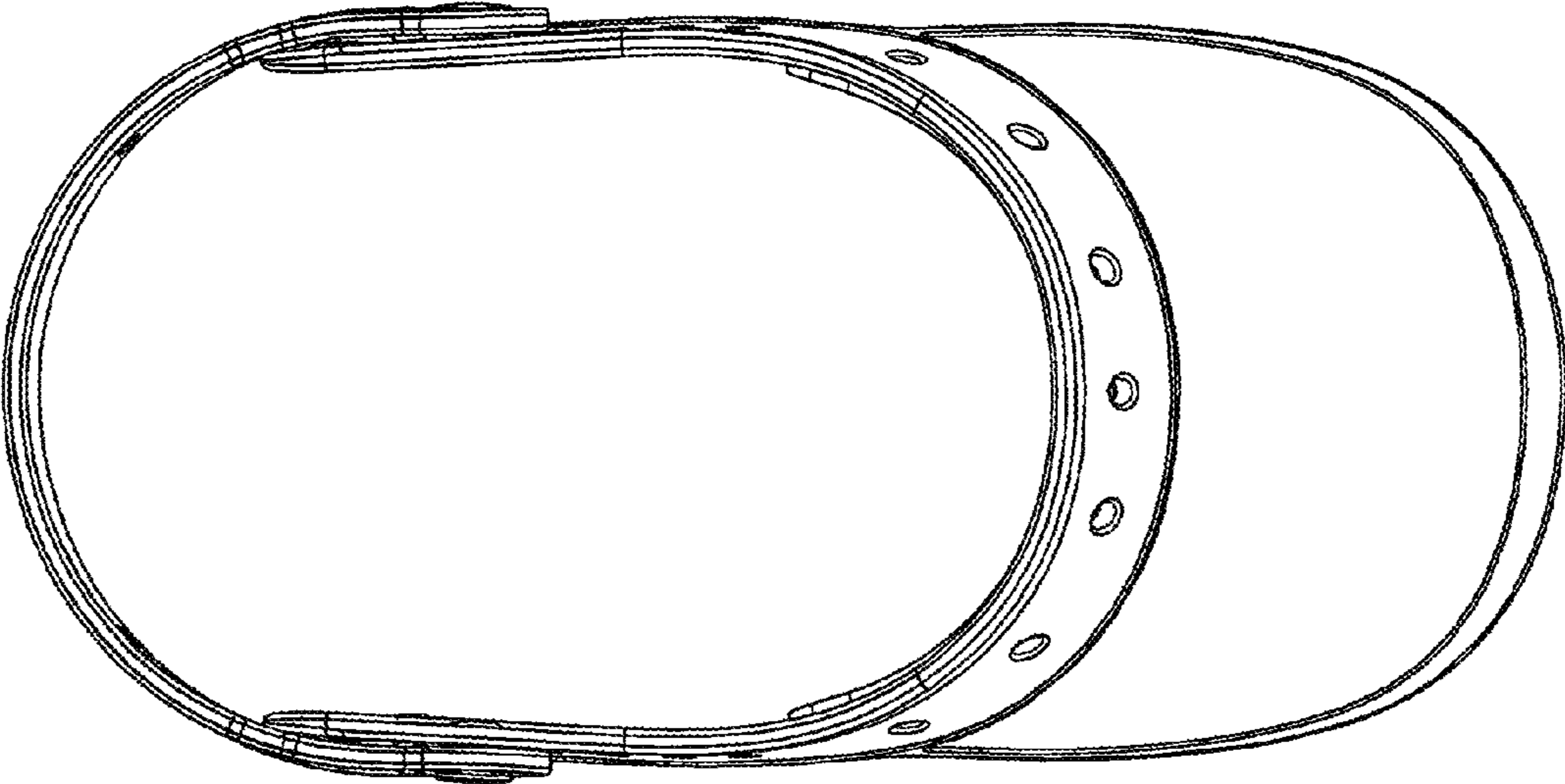

FIG. 11

