



US00D768869S

(12) **United States Design Patent**
Kasai

(10) **Patent No.:** **US D768,869 S**
(45) **Date of Patent:** **** Oct. 11, 2016**

(54) **SPECIMEN SAMPLING IMPLEMENT**

(71) Applicant: **ARKRAY, Inc.**, Kyoto-shi, Kyoto (JP)

(72) Inventor: **Tokuo Kasai**, Kyoto (JP)

(73) Assignee: **ARKRAY, Inc.**, Kyoto-shi (JP)

(**) Term: **14 Years**

(21) Appl. No.: **29/519,638**

(22) Filed: **Mar. 6, 2015**

(30) **Foreign Application Priority Data**

Oct. 20, 2014 (JP) 2014-023449

(51) **LOC (10) Cl.** **24-01**

(52) **U.S. Cl.**
USPC **D24/216; D24/222**

(58) **Field of Classification Search**
USPC D24/216-230, 231, 232, 107, 169, 186,
D24/112; D10/81
CPC G01N 35/11; B01L 3/5082; B01L 3/505
See application file for complete search history.

(56) **References Cited**

U.S. PATENT DOCUMENTS

- 5,766,962 A * 6/1998 Childs A61B 10/0038
422/255
- 5,948,359 A * 9/1999 Kalra G01N 1/312
422/510
- D593,205 S * 5/2009 Ayliffe D24/222
- D688,805 S * 8/2013 Page D24/222
- D698,458 S * 1/2014 Tsai D24/224
- D723,180 S * 2/2015 Klein D24/216

- D745,423 S * 12/2015 Khattak D10/81
- 2007/0031293 A1 * 2/2007 Beatty A61B 5/1411
422/400
- 2009/0110597 A1 * 4/2009 Ljungmann G01N 1/312
422/62
- 2011/0059547 A1 * 3/2011 Dehal B01L 3/502715
436/174
- 2014/0004548 A1 * 1/2014 Gordon B01L 3/5029
435/21
- 2015/0044764 A1 * 2/2015 Cha B01L 3/502715
435/288.7
- 2016/0054280 A1 * 2/2016 Root G01N 33/18
702/25

* cited by examiner

Primary Examiner — Anhdao Doan

(74) *Attorney, Agent, or Firm* — Fox Rothschild LLP

(57) **CLAIM**

The ornamental design for a specimen sampling implement, as shown and described.

DESCRIPTION

FIG. 1 is a front perspective view of the present invention; FIG. 2 is a rear perspective view thereof; FIG. 3 is a front elevational view thereof; FIG. 4 is a rear elevational view thereof; FIG. 5 is a right elevational view thereof; FIG. 6 is a left elevational view thereof; FIG. 7 is a top plan view thereof; and, FIG. 8 is a bottom plan view thereof.

The dash-dot-dash lines represent the bounds of the claim, and all other broken lines are directed to environment and are for illustrative purposes only. The broken lines form no part of the claimed design.

1 Claim, 7 Drawing Sheets

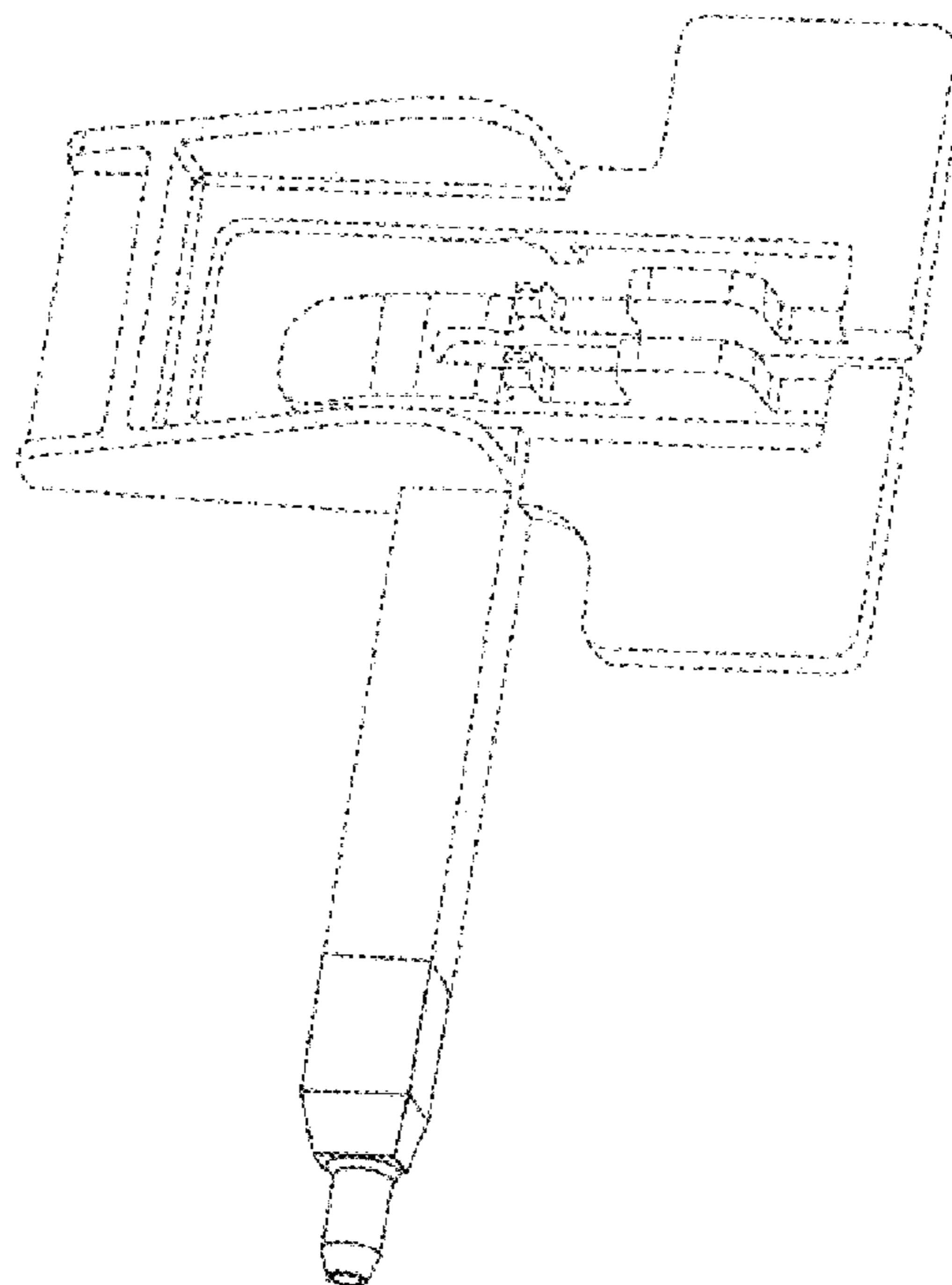

FIG. 1

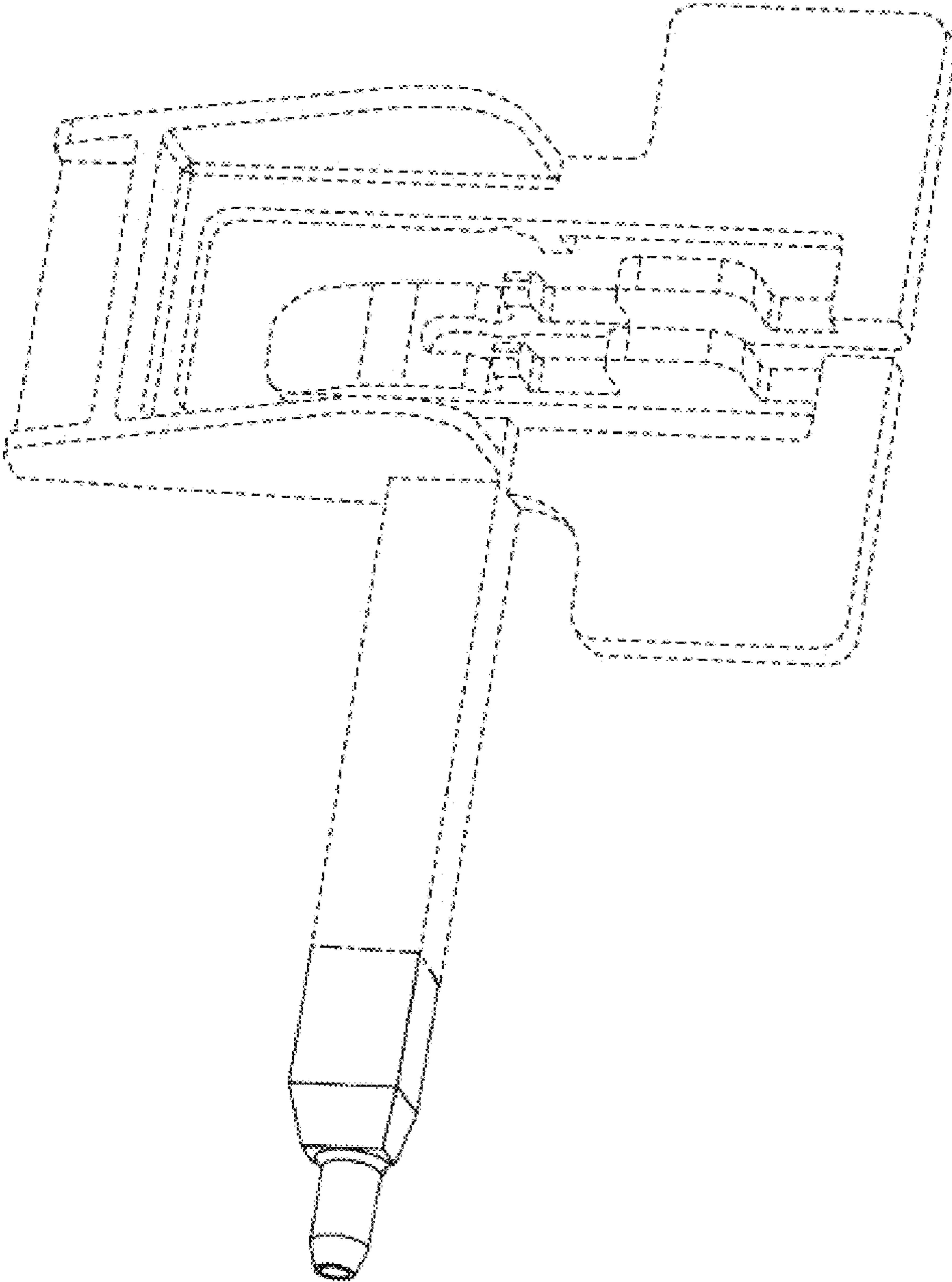

FIG. 2

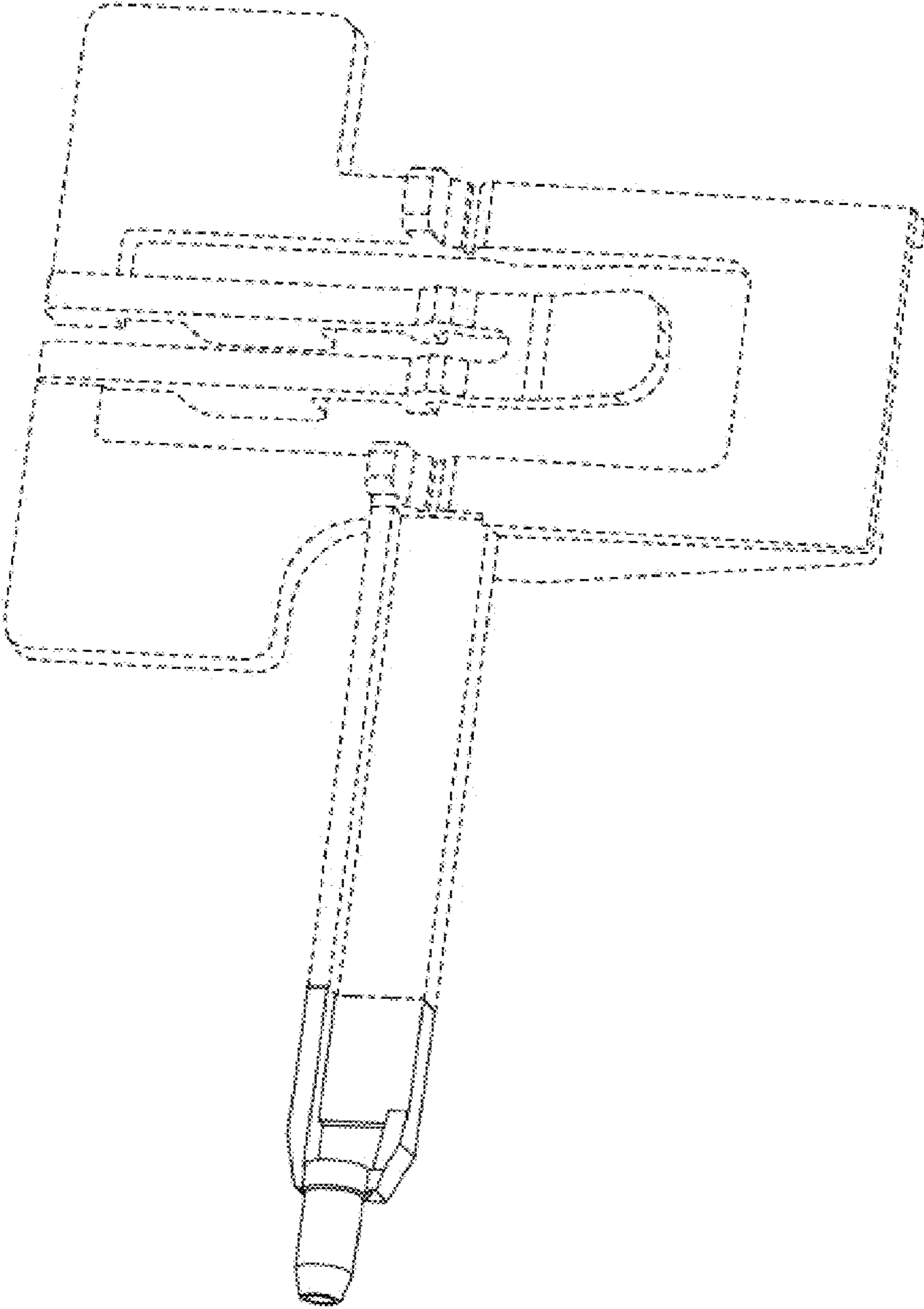

FIG. 3

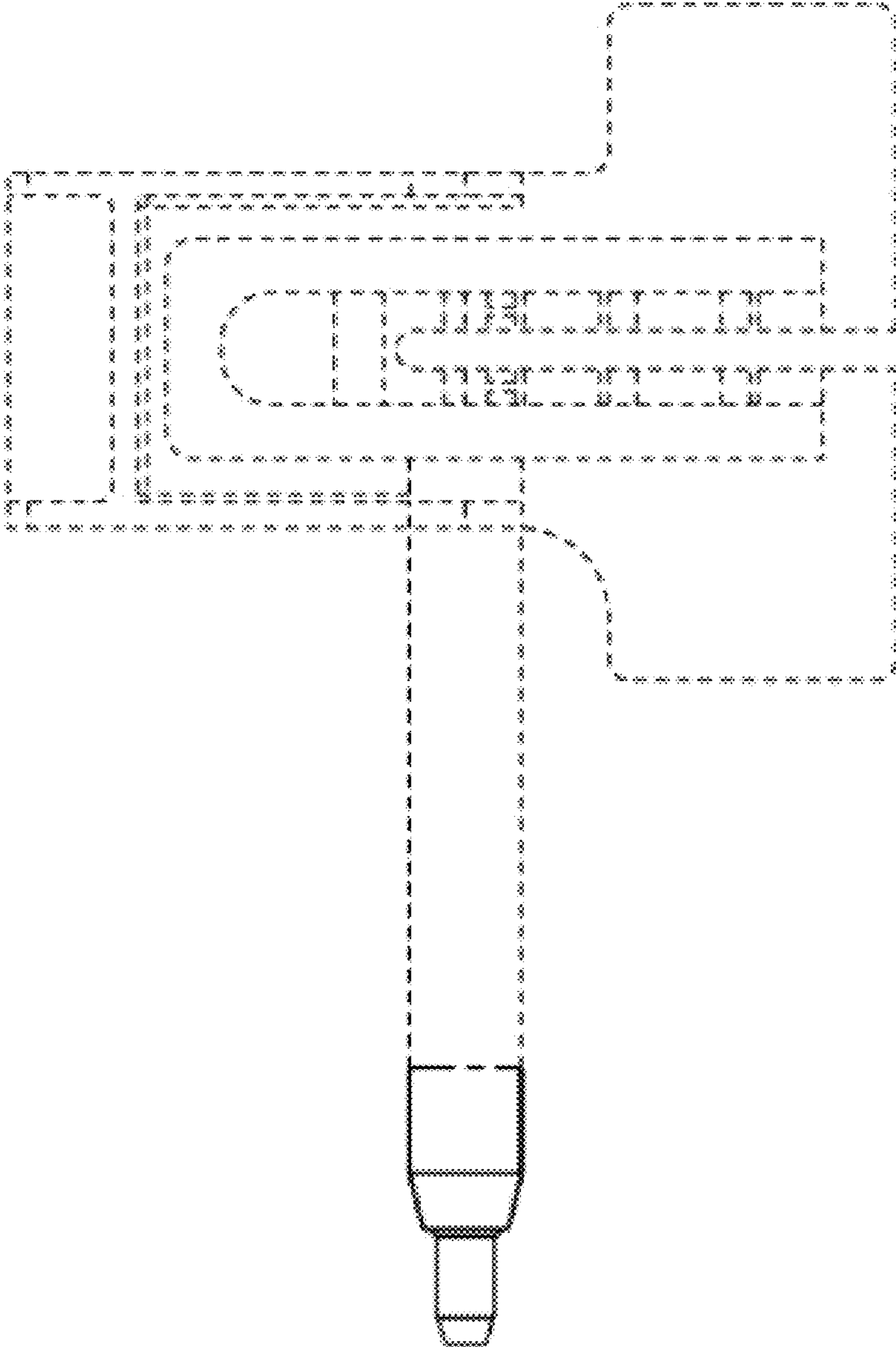

FIG. 4

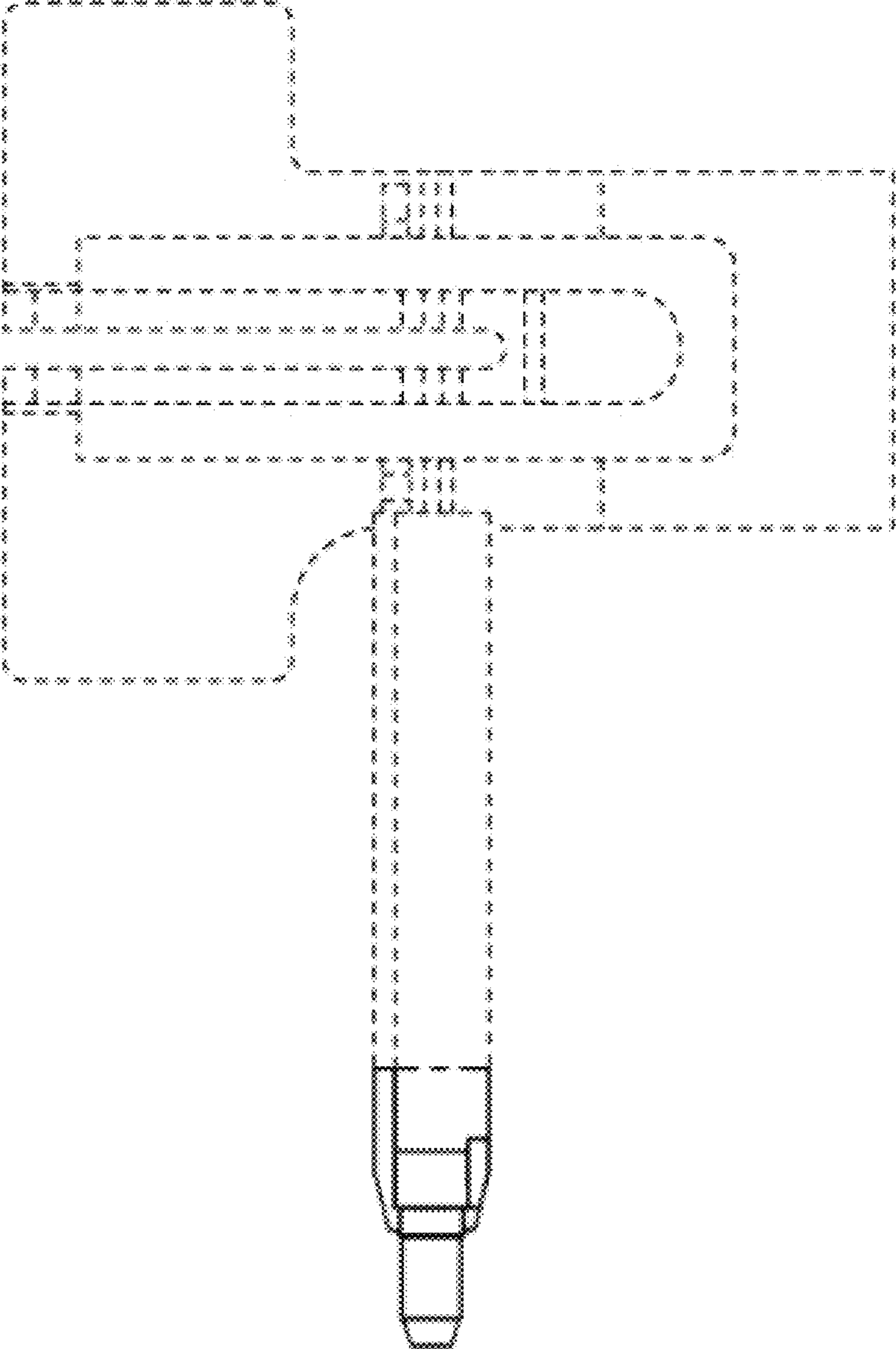

FIG. 5

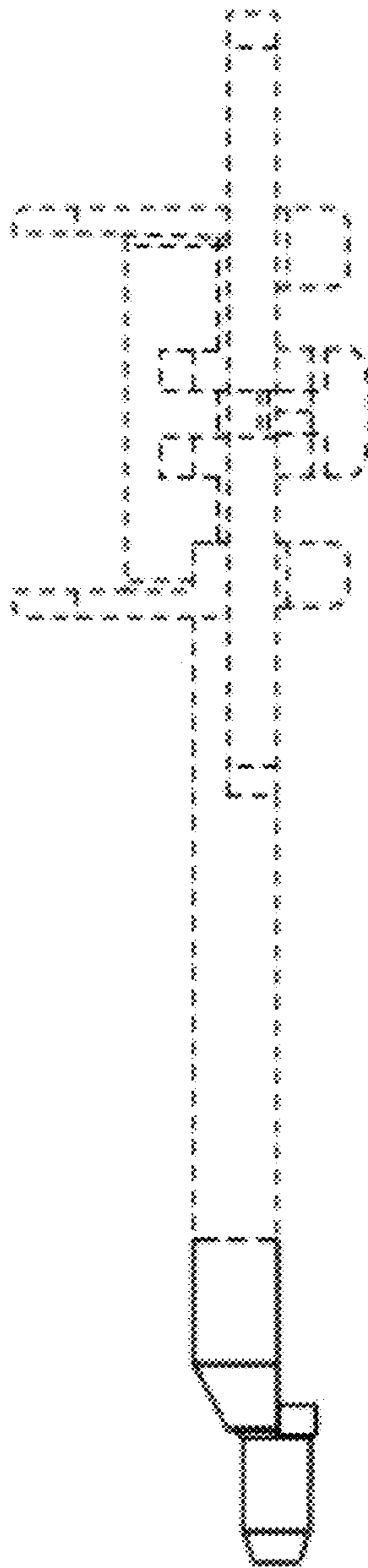

FIG. 6

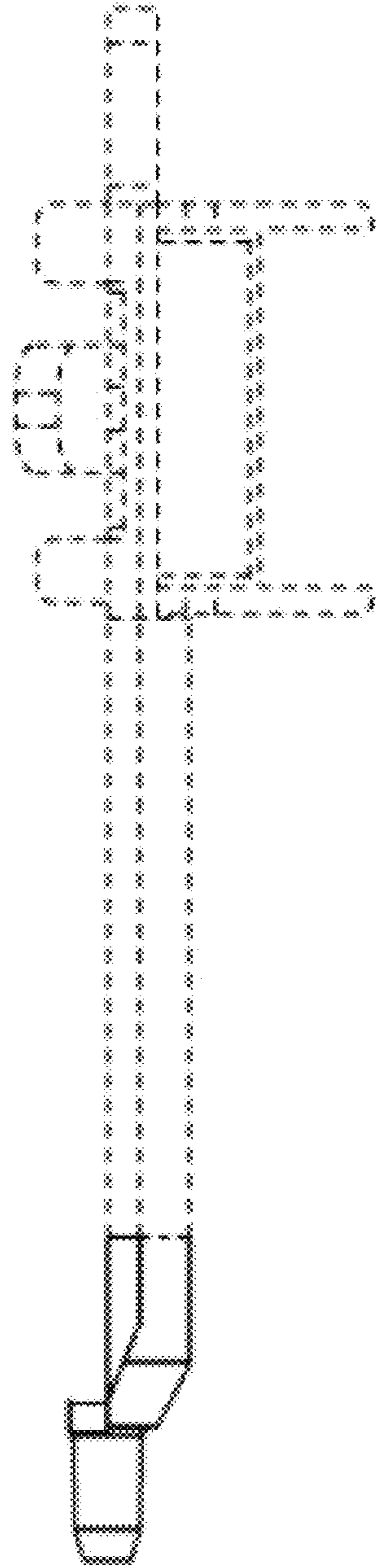

FIG. 7

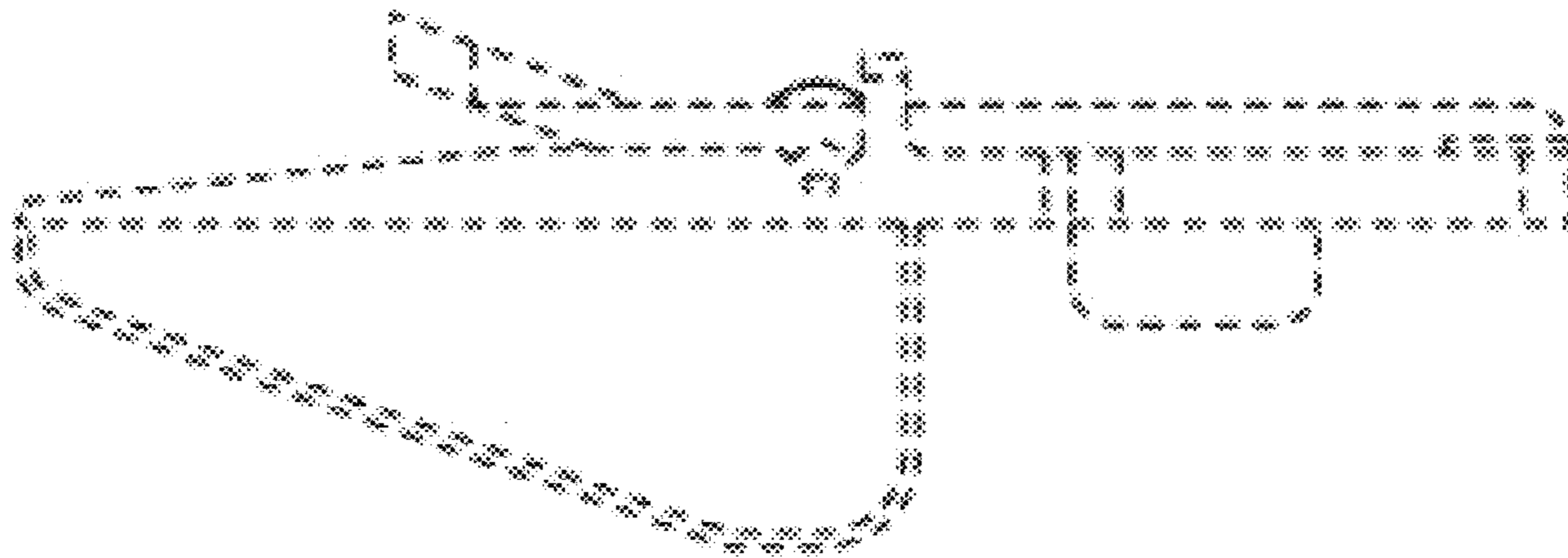

FIG. 8

