



US00D768854S

(12) **United States Design Patent**
Halleck et al.

(10) **Patent No.:** **US D768,854 S**
(45) **Date of Patent:** **** Oct. 11, 2016**

- (54) **ENDOSCOPIC VIDEO CAMERA**
- (71) Applicants: **Kevin E. Halleck**, Santa Barbara, CA (US); **Greg M. Chambers**, San Luis Obispo, CA (US); **Judi Wheeler**, Ventura, CA (US)
- (72) Inventors: **Kevin E. Halleck**, Santa Barbara, CA (US); **Greg M. Chambers**, San Luis Obispo, CA (US); **Judi Wheeler**, Ventura, CA (US)
- (73) Assignee: **Karl Storz Imaging, Inc.**, Goleta, CA (US)
- (**) Term: **15 Years**
- (21) Appl. No.: **29/530,978**

D598,545 S *	8/2009	Haines, III	D24/137
D607,032 S	12/2009	Halleck et al.	
D639,428 S *	6/2011	Yasue	D24/137
D643,534 S	8/2011	Halleck et al.	
D651,312 S	12/2011	Halleck et al.	
D664,647 S *	7/2012	Becker	D24/133
D664,648 S *	7/2012	Becker	D24/133
D664,649 S *	7/2012	Becker	D24/133
D669,580 S *	10/2012	Eisenkolb	D24/137
D670,383 S *	11/2012	Eisenkolb	D24/137
D672,462 S *	12/2012	Campo	D24/138
D687,476 S	8/2013	Halleck et al.	
D695,228 S	12/2013	Halleck et al.	
D716,942 S *	11/2014	Eisenkolb	D24/138
D717,432 S *	11/2014	Leroy	D24/138
D720,069 S *	12/2014	Kaercher	D24/133
D739,016 S *	9/2015	Berci	D24/138
D743,027 S *	11/2015	Renner	D24/138
2005/0267329 A1	12/2005	Konstorum et al.	
2007/0276183 A1	11/2007	Melder	
2010/0069711 A1	3/2010	Deng et al.	

- (22) Filed: **Jun. 22, 2015**
- (51) **LOC (10) Cl.** **24-02**
- (52) **U.S. Cl.**
USPC **D24/138**
- (58) **Field of Classification Search**
USPC D24/133, 137, 138, 222, 141, 108, 111, D24/113, 127, 143, 148, 179, 216, 152, 153, D24/154, 176; D8/4, 29.1, 29.2, 30, 31, 39
CPC A61B 1/00128; A61B 1/018; A61B 17/320016; A61B 17/3423; A61B 1/00135; A61B 1/12; A61B 2017/00477; A61B 2017/347; A61B 17/00234; A61B 17/00491; A61B 1/00066; A61B 1/00133; A61B 1/00147
See application file for complete search history.

- (56) **References Cited**
U.S. PATENT DOCUMENTS
D474,276 S 5/2003 Greise et al.
D474,745 S 5/2003 Amling et al.
D482,334 S 11/2003 Amling et al.
D501,864 S 2/2005 Greise et al.
D523,455 S 6/2006 Greise et al.
D581,051 S 11/2008 Melder
D587,804 S 3/2009 Ruiz et al.

OTHER PUBLICATIONS
U.S. Appl. No. 29/441,115, filed Dec. 31, 2012, Mirrer, et al.
* cited by examiner
Primary Examiner — Robert M Spear
Assistant Examiner — Eliza Bennett-Hattan
(74) *Attorney, Agent, or Firm* — Whitmyer IP Group LLC

(57) **CLAIM**
The ornamental design for an endoscopic video camera, as shown and described.

DESCRIPTION
FIG. 1 is a front and right side isometric view of an endoscopic video camera in accordance with the new design;
FIG. 2 is a top plan view thereof;
FIG. 3 is a bottom plan view thereof;
FIG. 4 is a right side elevational view thereof;
FIG. 5 is a left side elevational view thereof;
FIG. 6 is a front elevational view thereof; and,
FIG. 7 is a rear elevational view thereof.

1 Claim, 7 Drawing Sheets

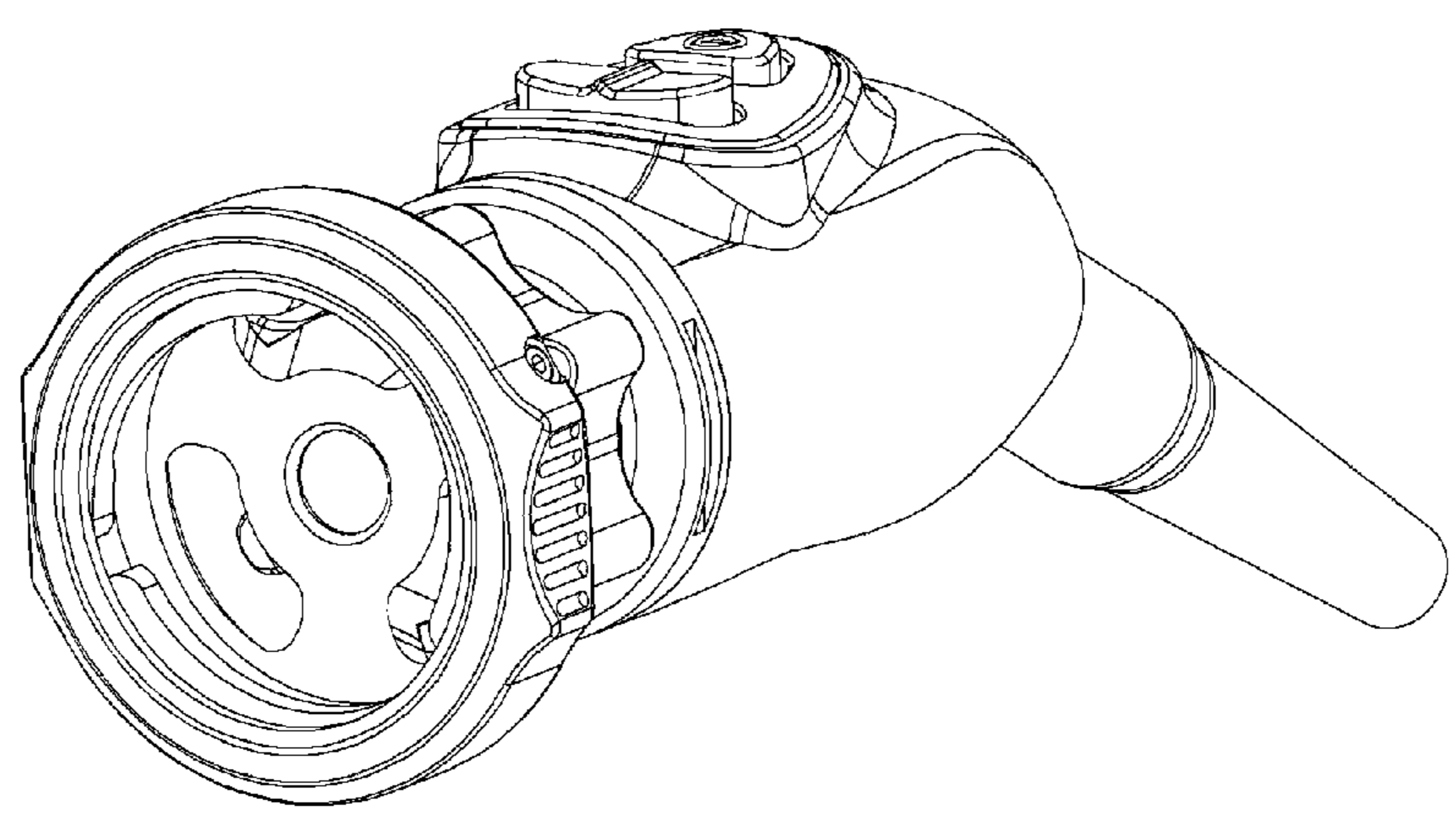

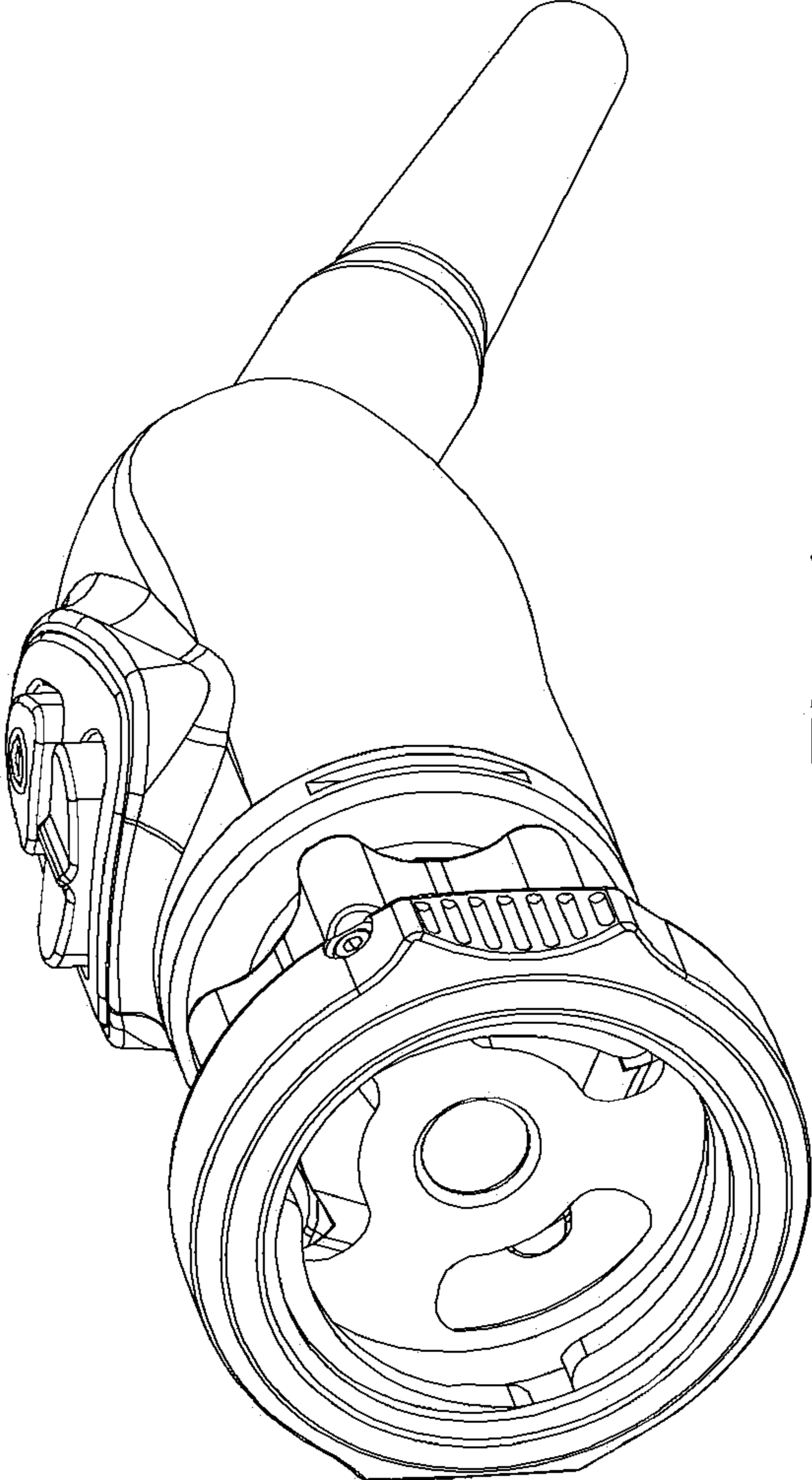

Fig. 1

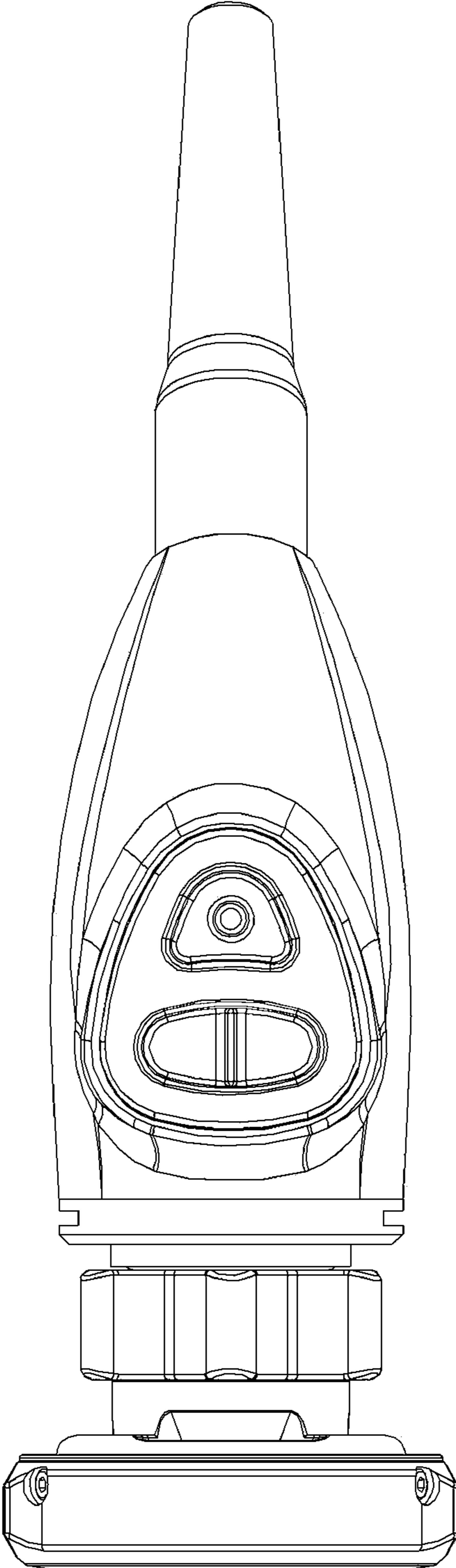

Fig. 2

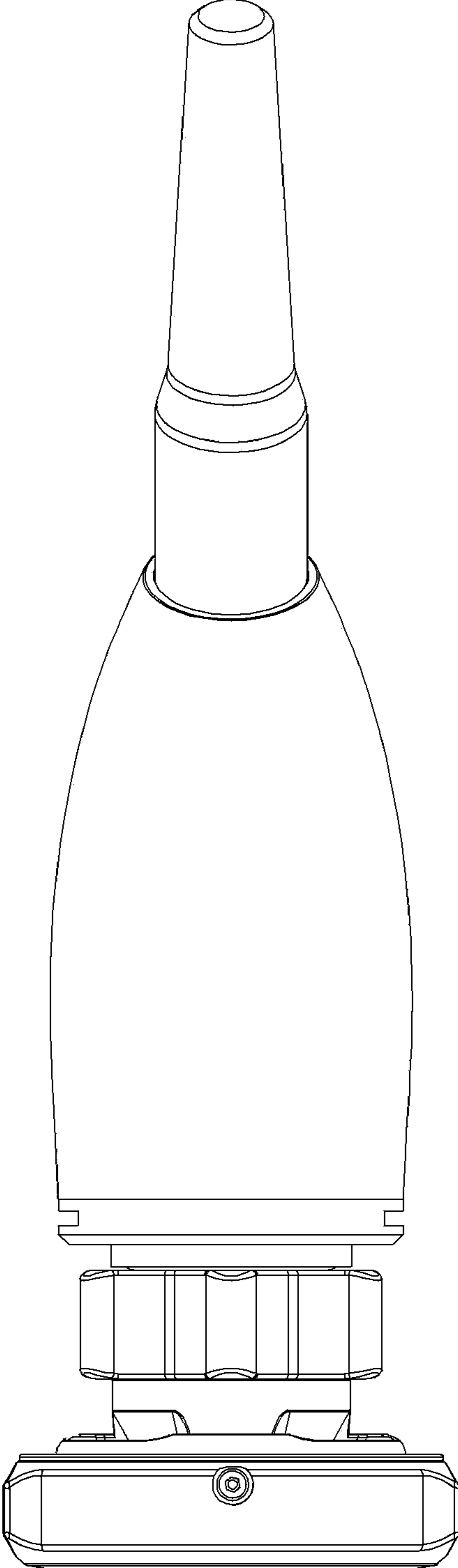

Fig. 3

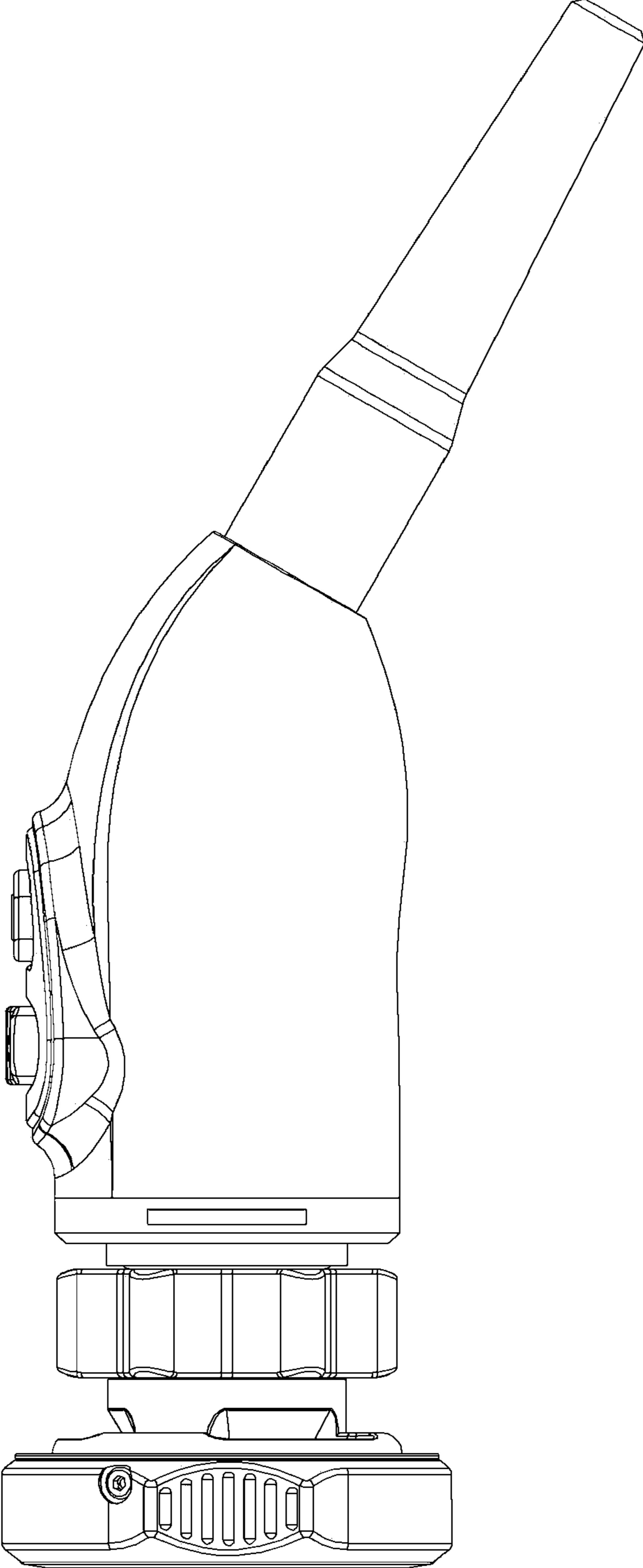

Fig. 4

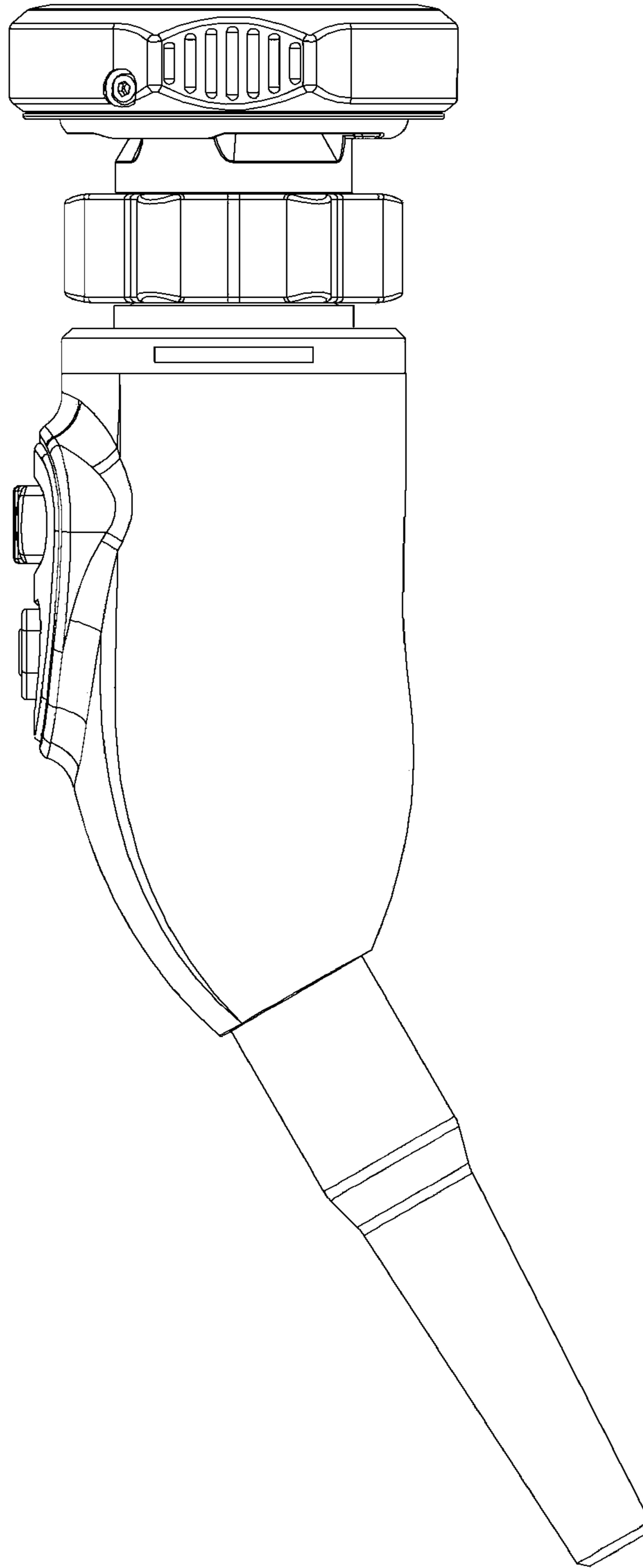

Fig. 5

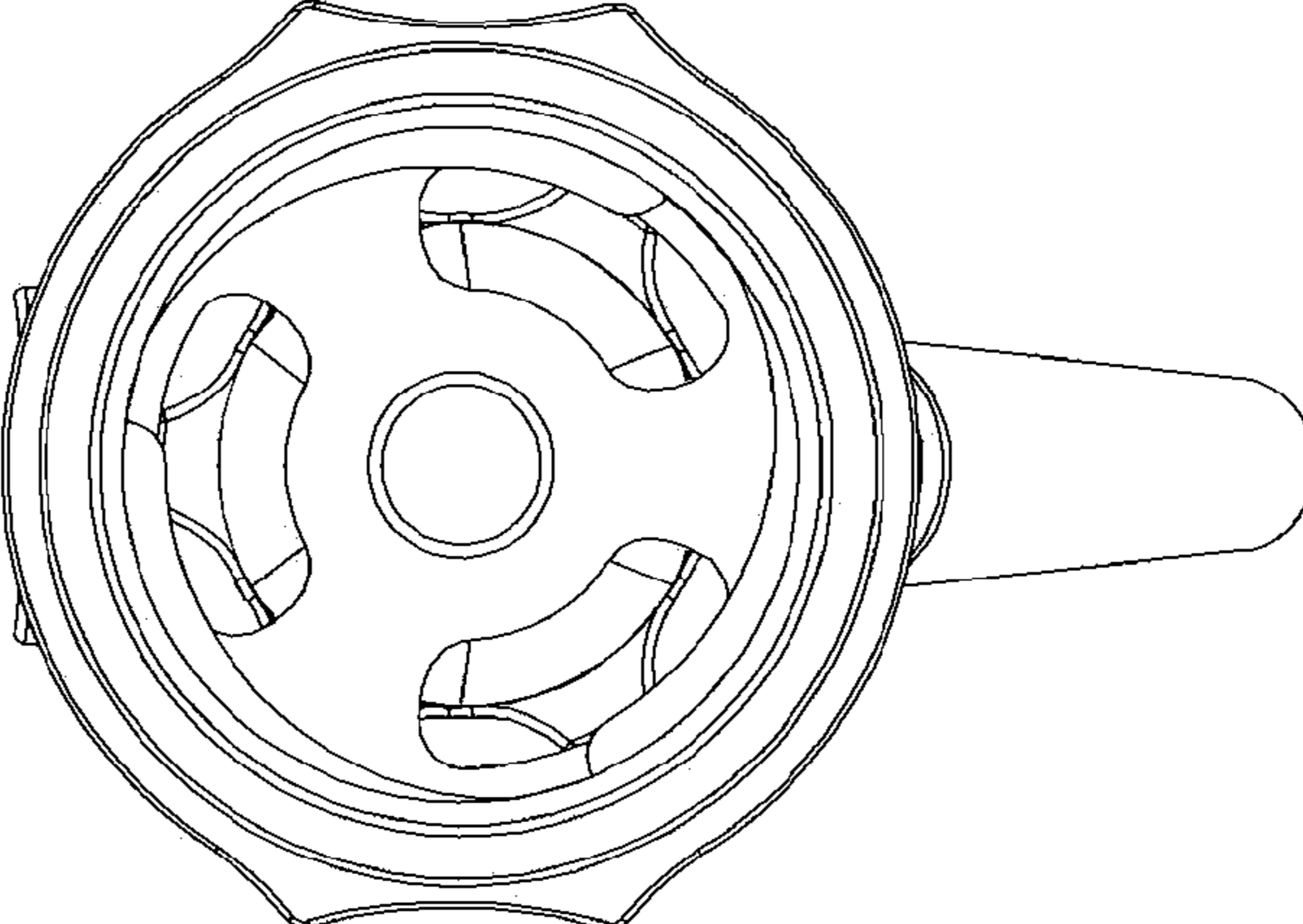

Fig. 6

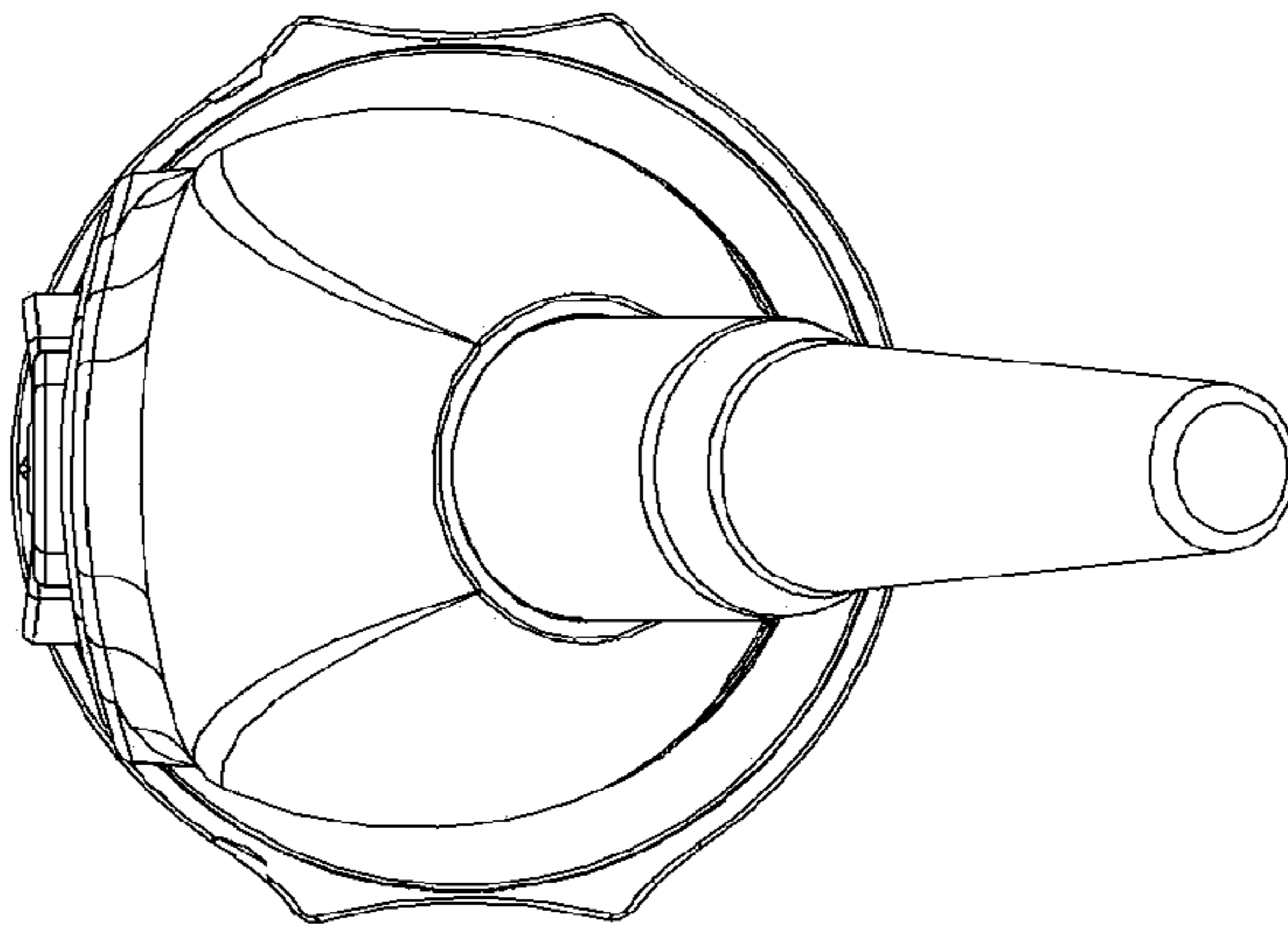

Fig. 7