



US00D768739S

(12) **United States Design Patent**
Lee et al.

(10) **Patent No.:** **US D768,739 S**
(45) **Date of Patent:** **** Oct. 11, 2016**

(54) **REFRIGERATOR DOOR**

D707,735 S * 6/2014 Cho D15/91
D723,595 S * 3/2015 You D15/91
D738,942 S * 9/2015 Choi D15/91

(71) Applicant: **LG ELECTRONICS INC.**, Seoul
(KR)

* cited by examiner

(72) Inventors: **Hangbok Lee**, Seoul (KR); **Hongsik Kwon**, Seoul (KR); **Minsub Kim**, Seoul (KR); **Jungkyu Son**, Seoul (KR); **Eugene Suh**, Seoul (KR); **Junyi Heo**, Seoul (KR)

Primary Examiner — Daniel Bui
Assistant Examiner — Khawaja Anwar
(74) *Attorney, Agent, or Firm* — Birch, Stewart, Kolasch & Birch, LLP

(73) Assignee: **LG ELECTRONICS INC.**, Seoul
(KR)

(57) **CLAIM**

We claim the ornamental design for a refrigerator door, as shown and described.

(**) Term: **14 Years**

DESCRIPTION

(21) Appl. No.: **29/522,070**

(22) Filed: **Mar. 27, 2015**

(30) **Foreign Application Priority Data**

Jan. 13, 2015 (KR) 30-2015-0001566

(51) **LOC (10) Cl.** **15-07**

(52) **U.S. Cl.**
USPC **D15/91**

(58) **Field of Classification Search**
USPC D15/79-91; D6/559-561; D32/1, 5, D32/8-10, 25
CPC F25D 23/028; F25D 23/02; F25D 23/00; F25D 2323/021; F25D 11/00; F25D 2323/024; F25D 23/04; F25D 29/00; F25D 25/02; F25D 25/024; F25D 27/005; F25D 29/005; F25D 17/042; F25D 2325/021; F25D 25/025; F25D 23/12

See application file for complete search history.

FIG. 1 is a perspective view of a refrigerator door showing our new design, with its inner door closed;
FIG. 2 is a front elevation view thereof;
FIG. 3 is a rear elevation view thereof;
FIG. 4 is a left-side elevation view thereof;
FIG. 5 is a right-side elevation view thereof;
FIG. 6 is a top plan view thereof;
FIG. 7 is a bottom plan view thereof;
FIG. 8 is a perspective view with the inner door thereof opened;
FIG. 9 is a front elevation view with the inner door thereof opened;
FIG. 10 is a right-side elevation view with the inner door thereof opened;
FIG. 11 is a top plan view with the inner door thereof opened;
FIG. 12 is a perspective view thereof, shown in a typical environment in use condition;
FIG. 13 is a perspective view thereof, shown in use in a typical environment; and,
FIG. 14 is another perspective view thereof, shown in use in a typical environment.

The broken lines in the drawing figures are included for the purpose of illustrating environment and form no part of the claimed design.

(56) **References Cited**

U.S. PATENT DOCUMENTS

D321,451 S * 11/1991 Greve D6/559
D497,069 S * 10/2004 Aisley D6/559
D544,277 S * 6/2007 Hoyvik D6/559
D702,742 S * 4/2014 Hwan D15/91

1 Claim, 13 Drawing Sheets

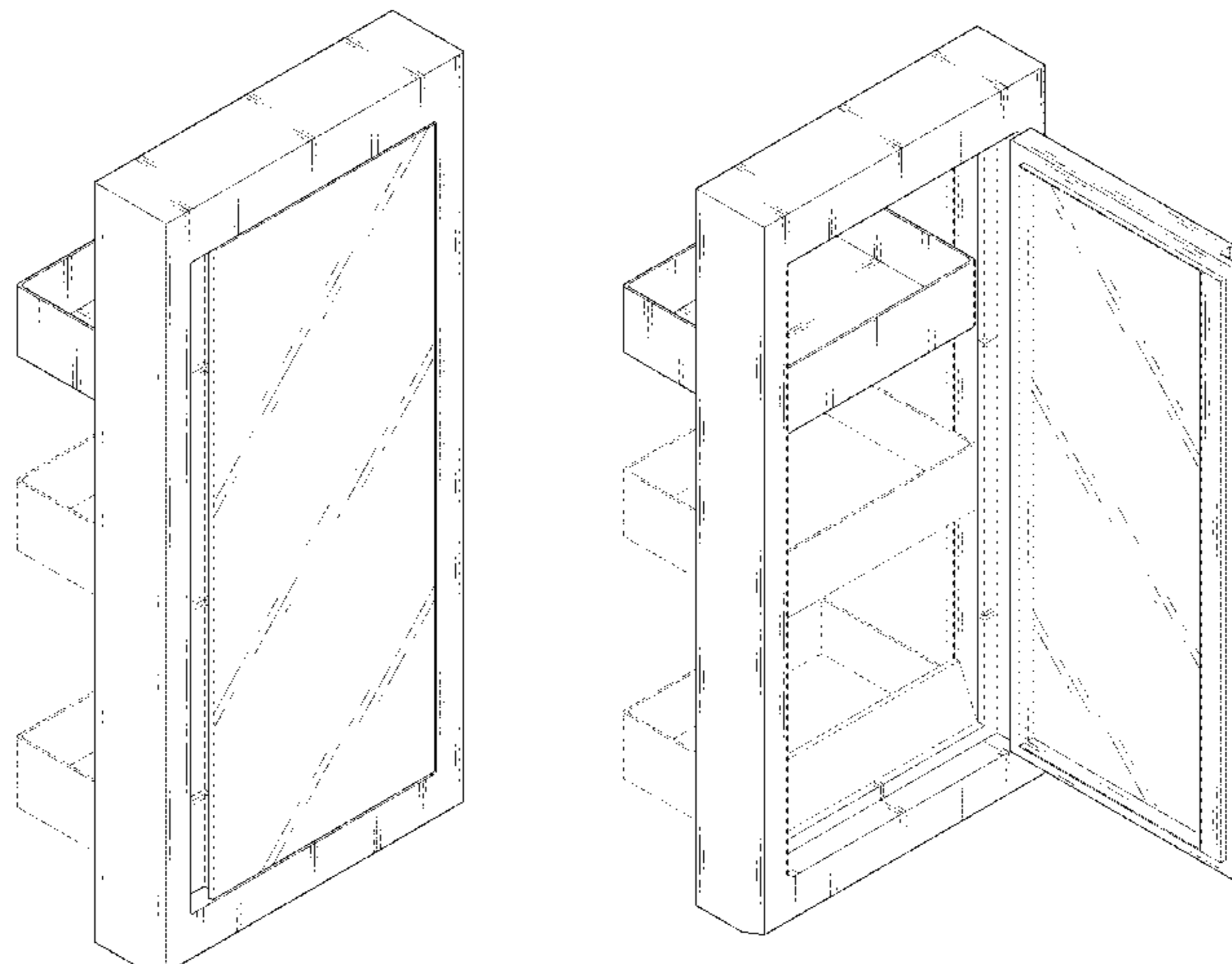

FIG. 1

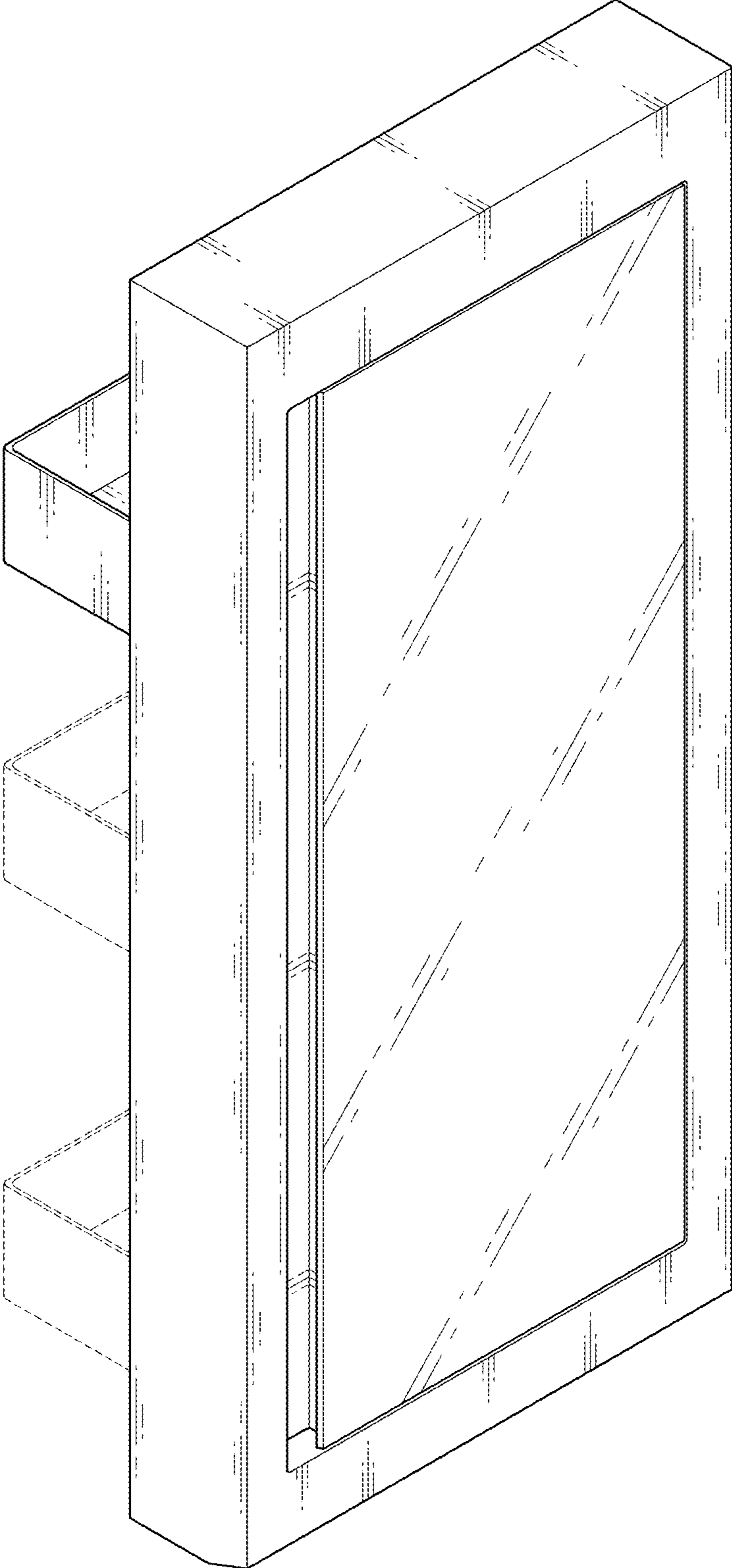

FIG. 2

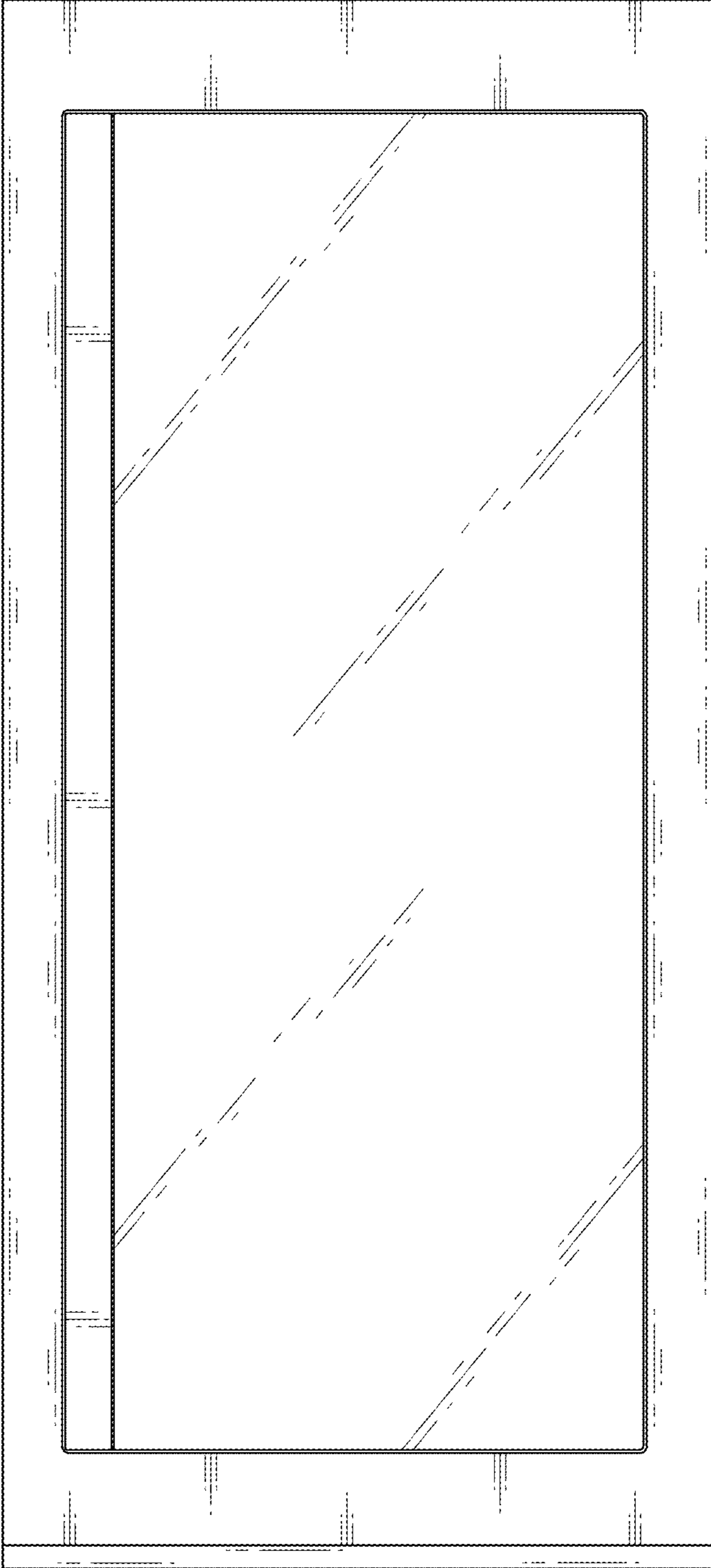

FIG. 3

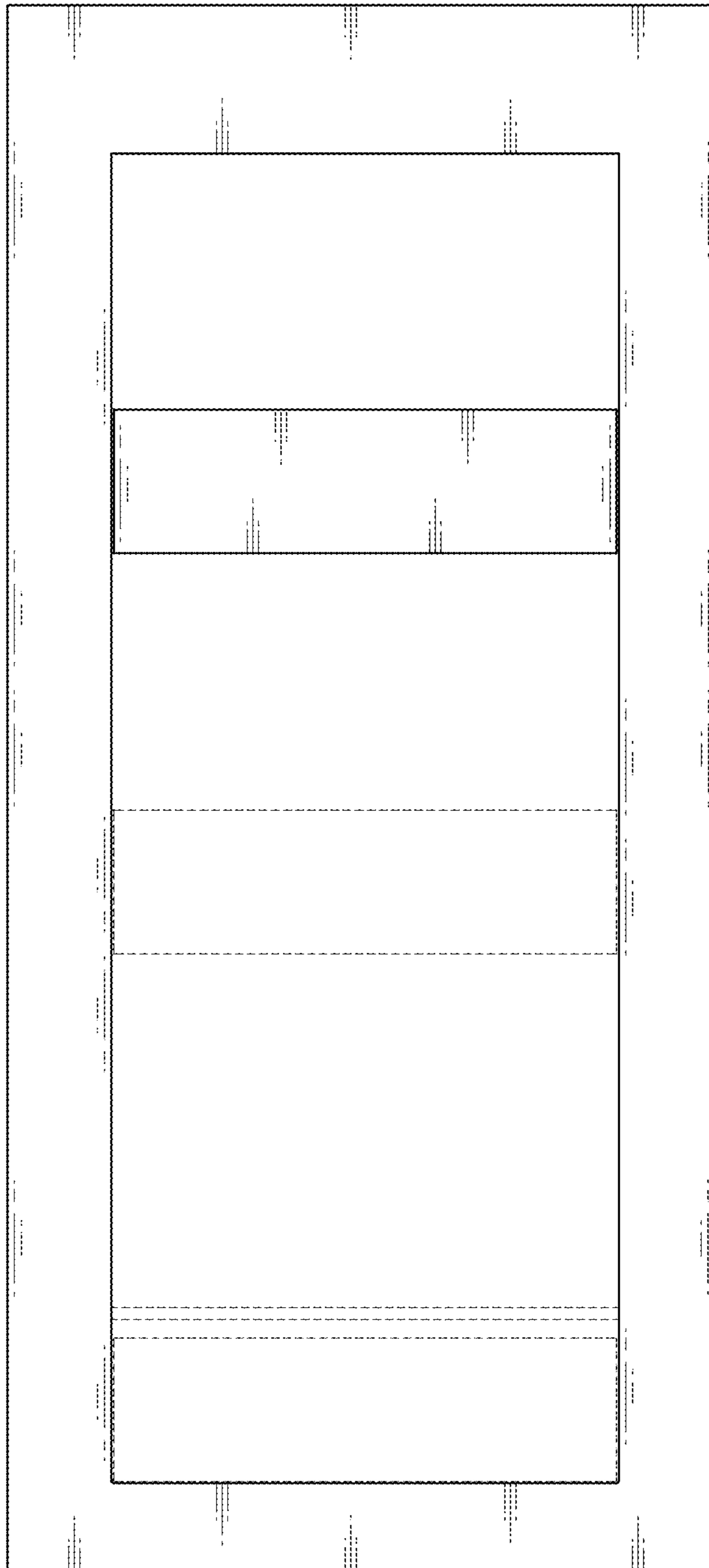

FIG. 4

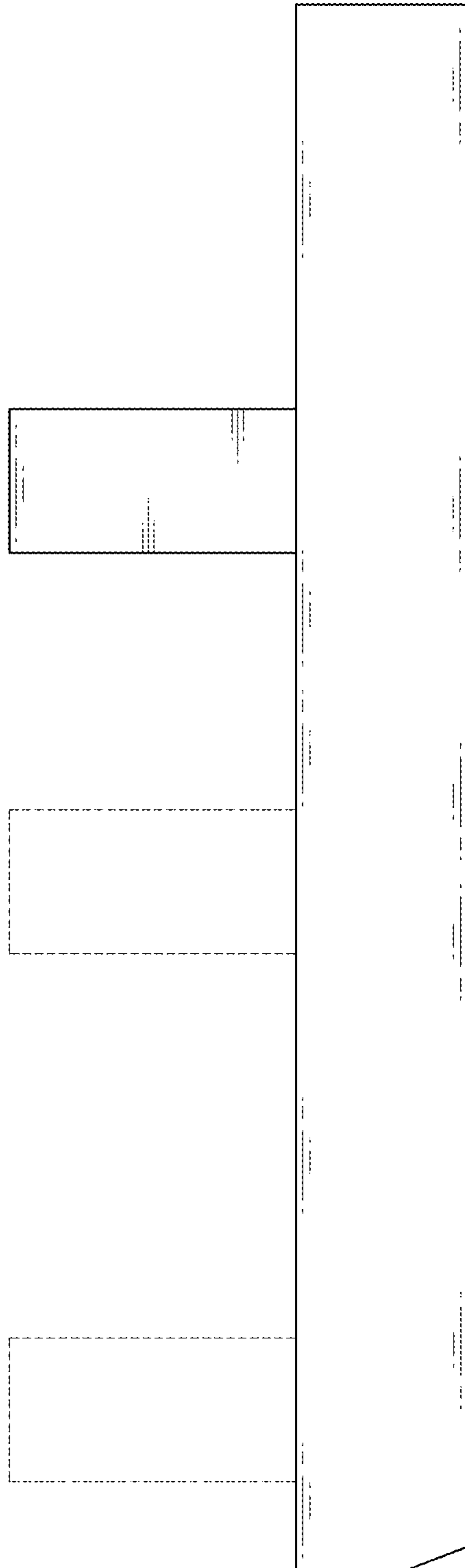

FIG. 5

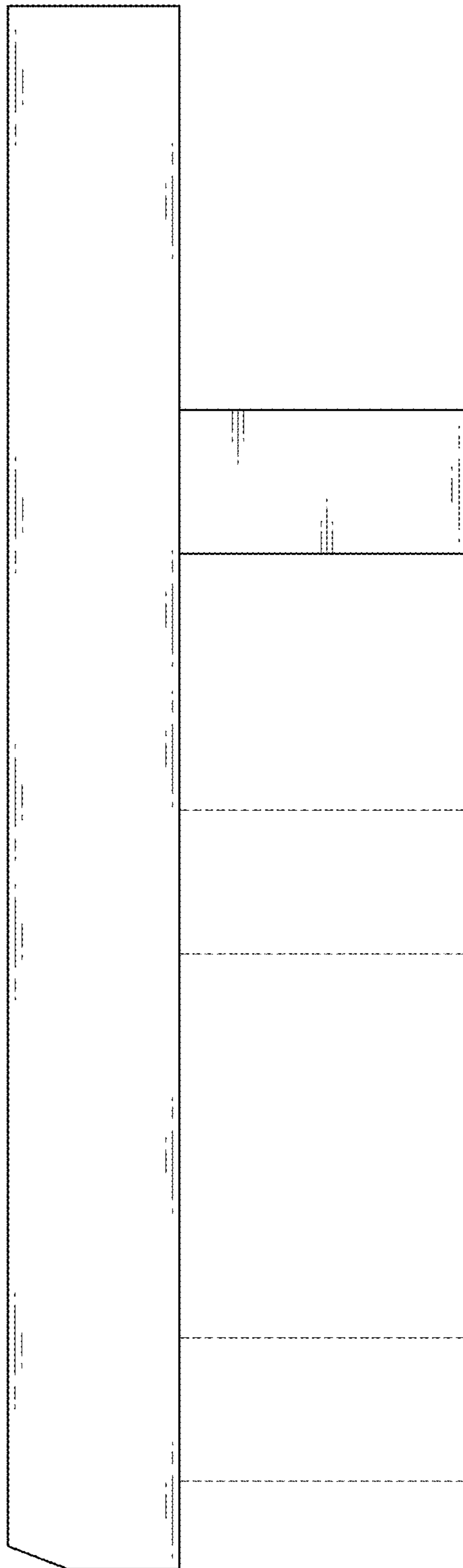

FIG. 6

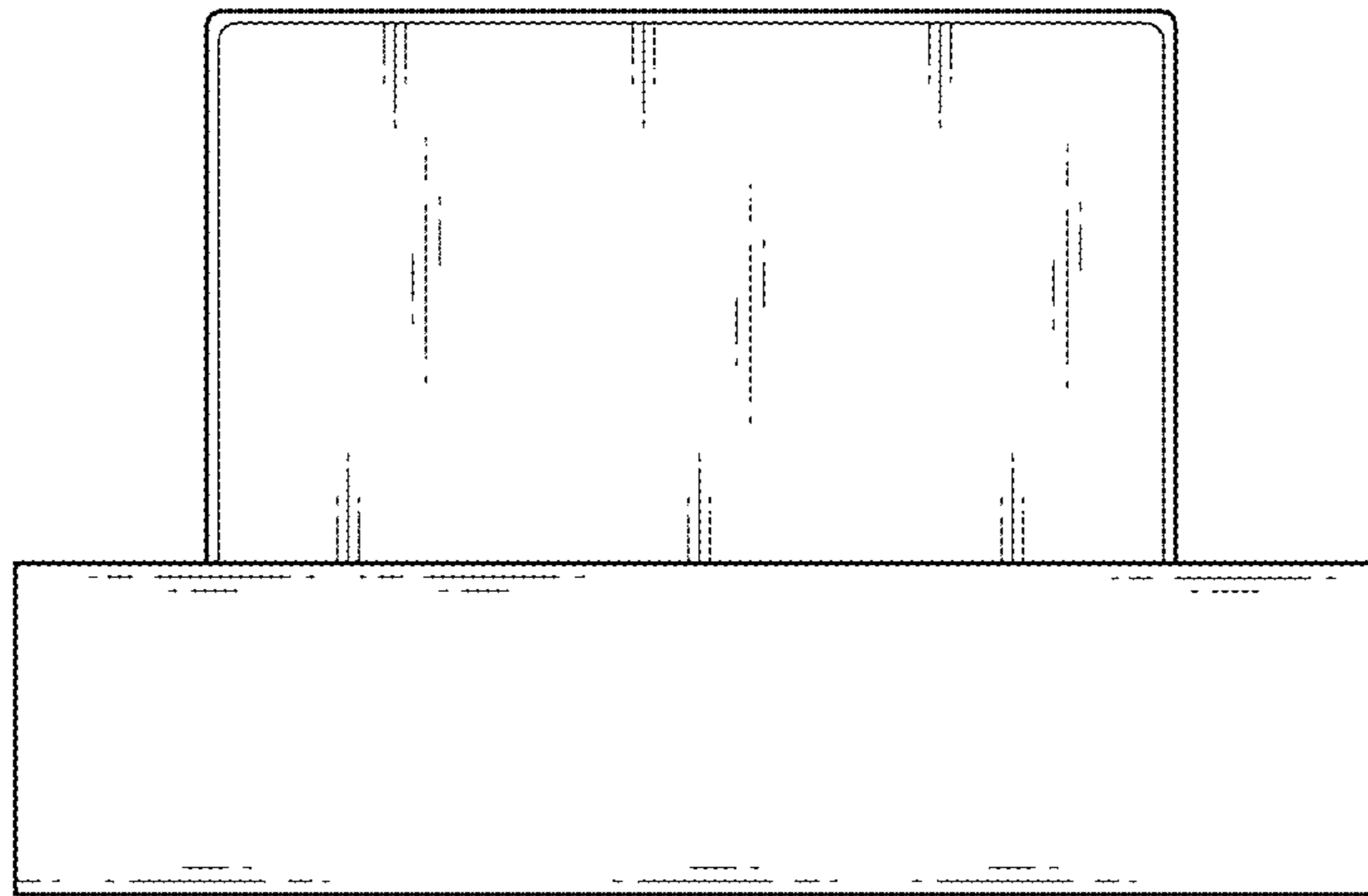

FIG. 7

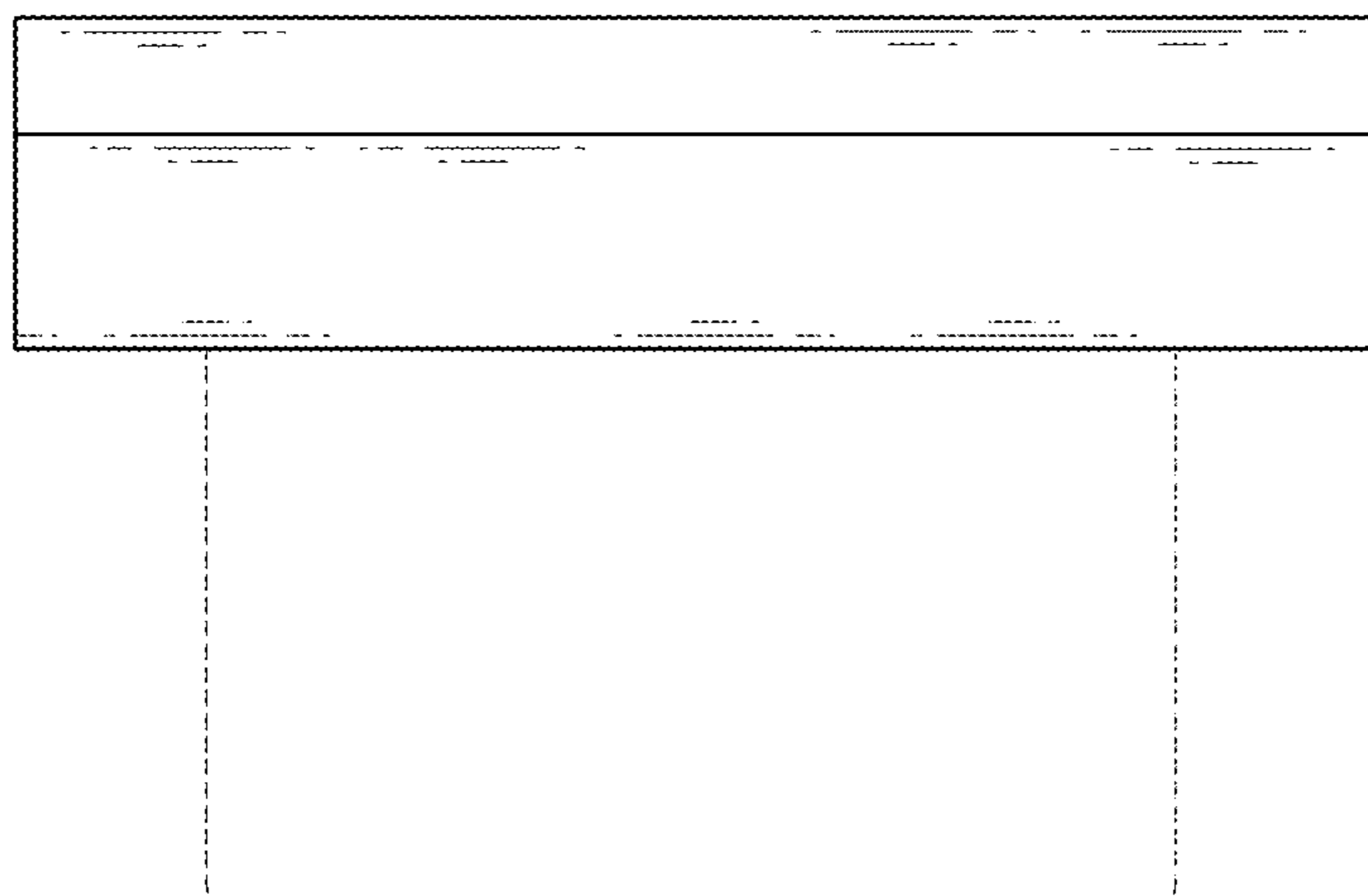

FIG. 8

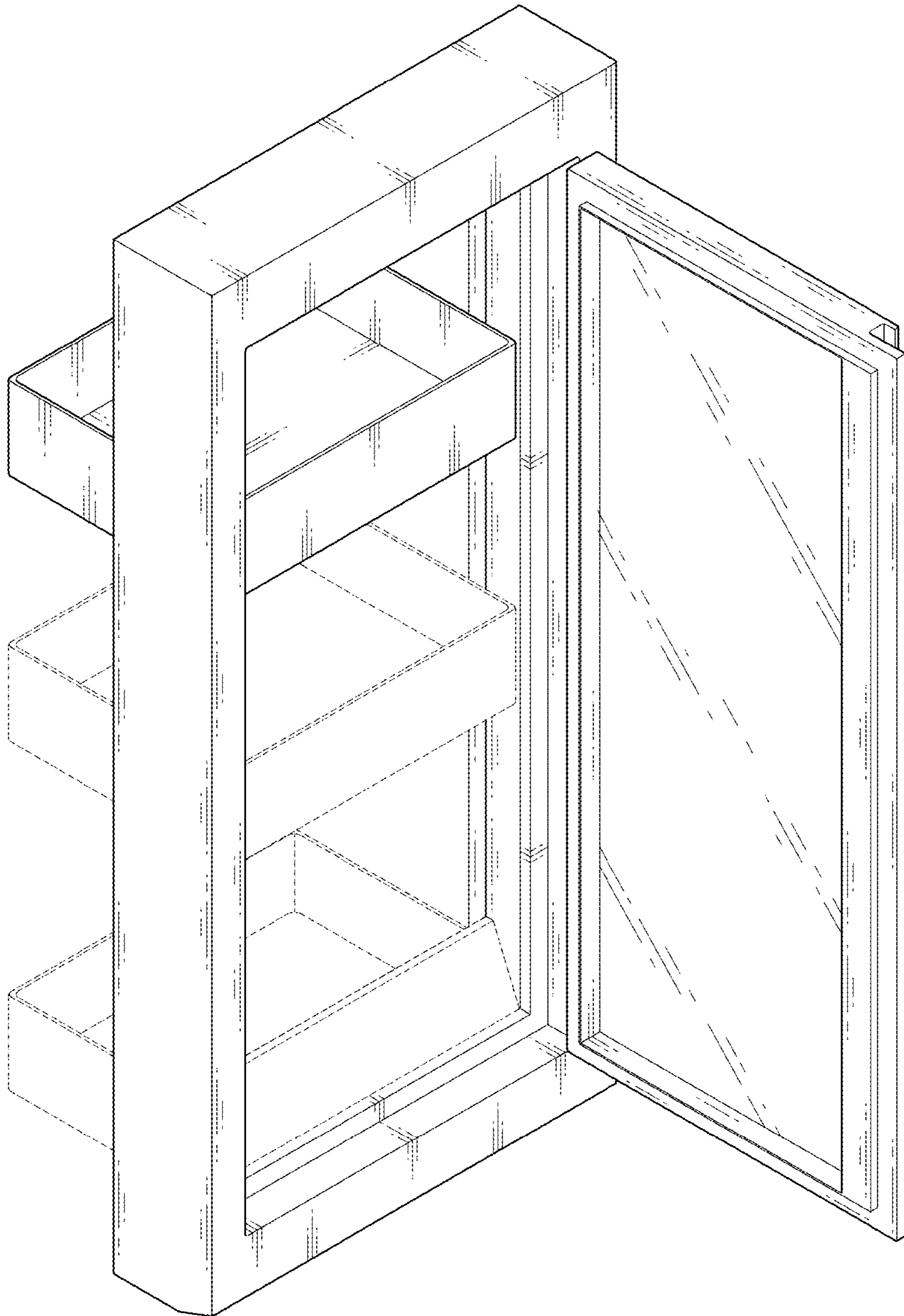

FIG. 9

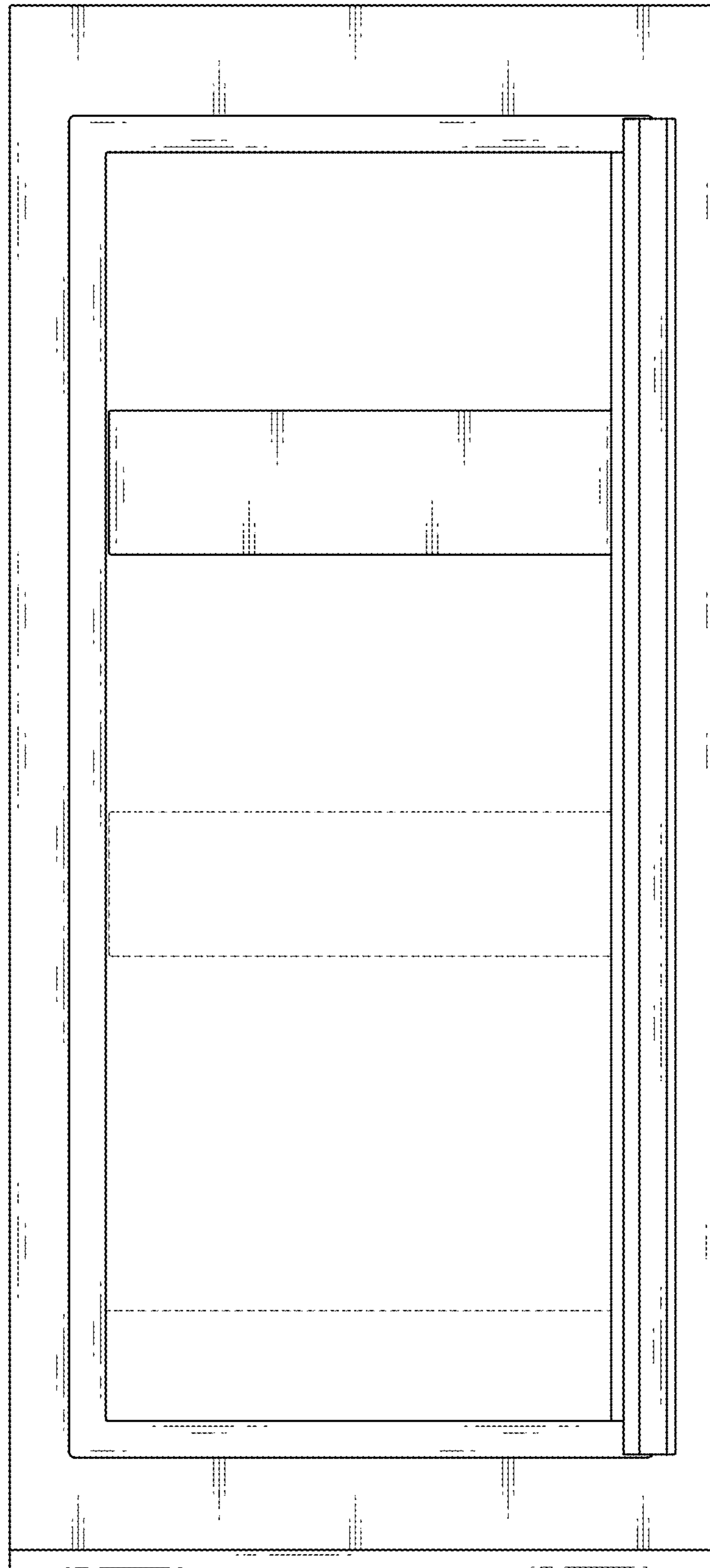

FIG. 10

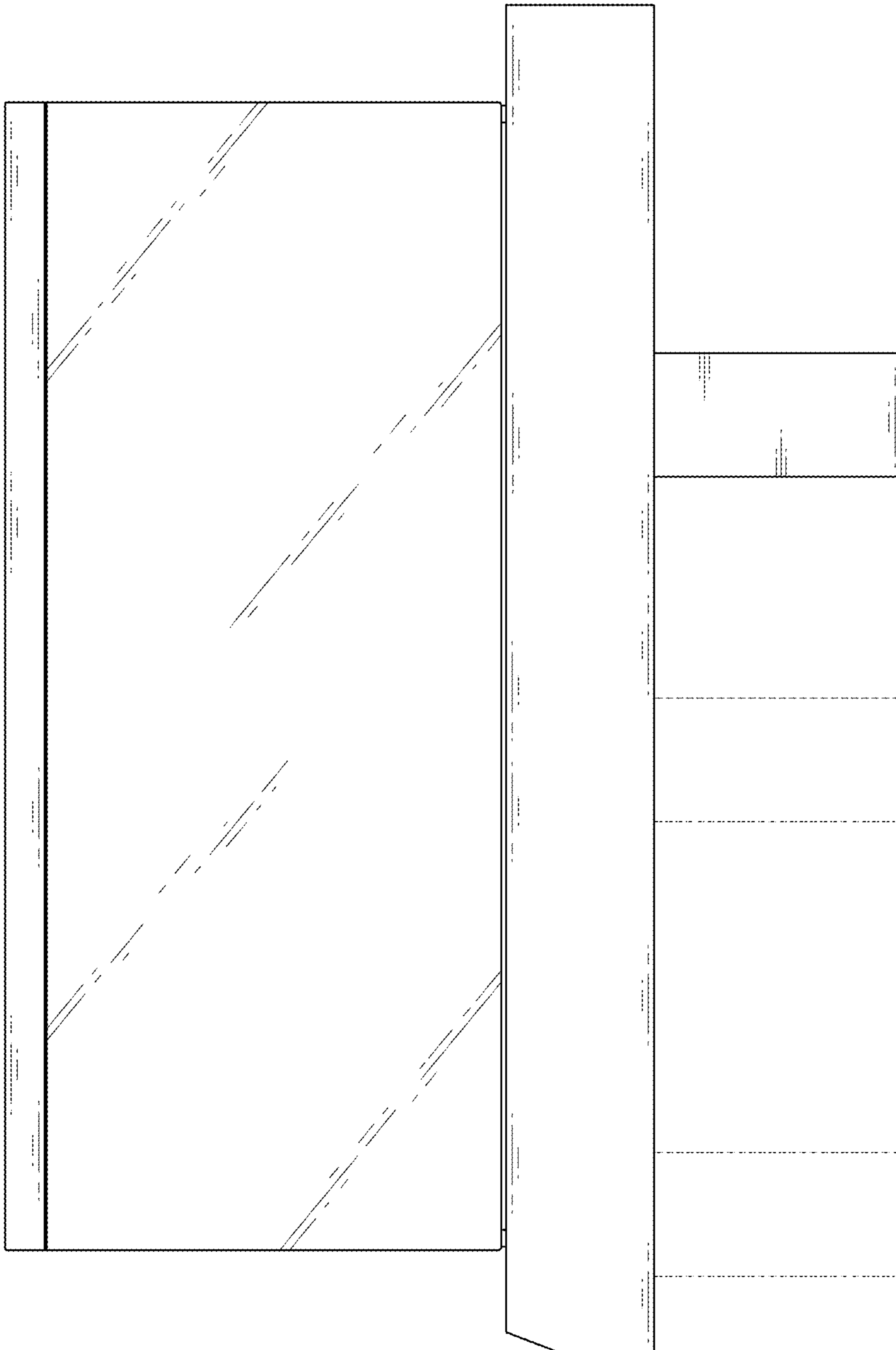

FIG. 11

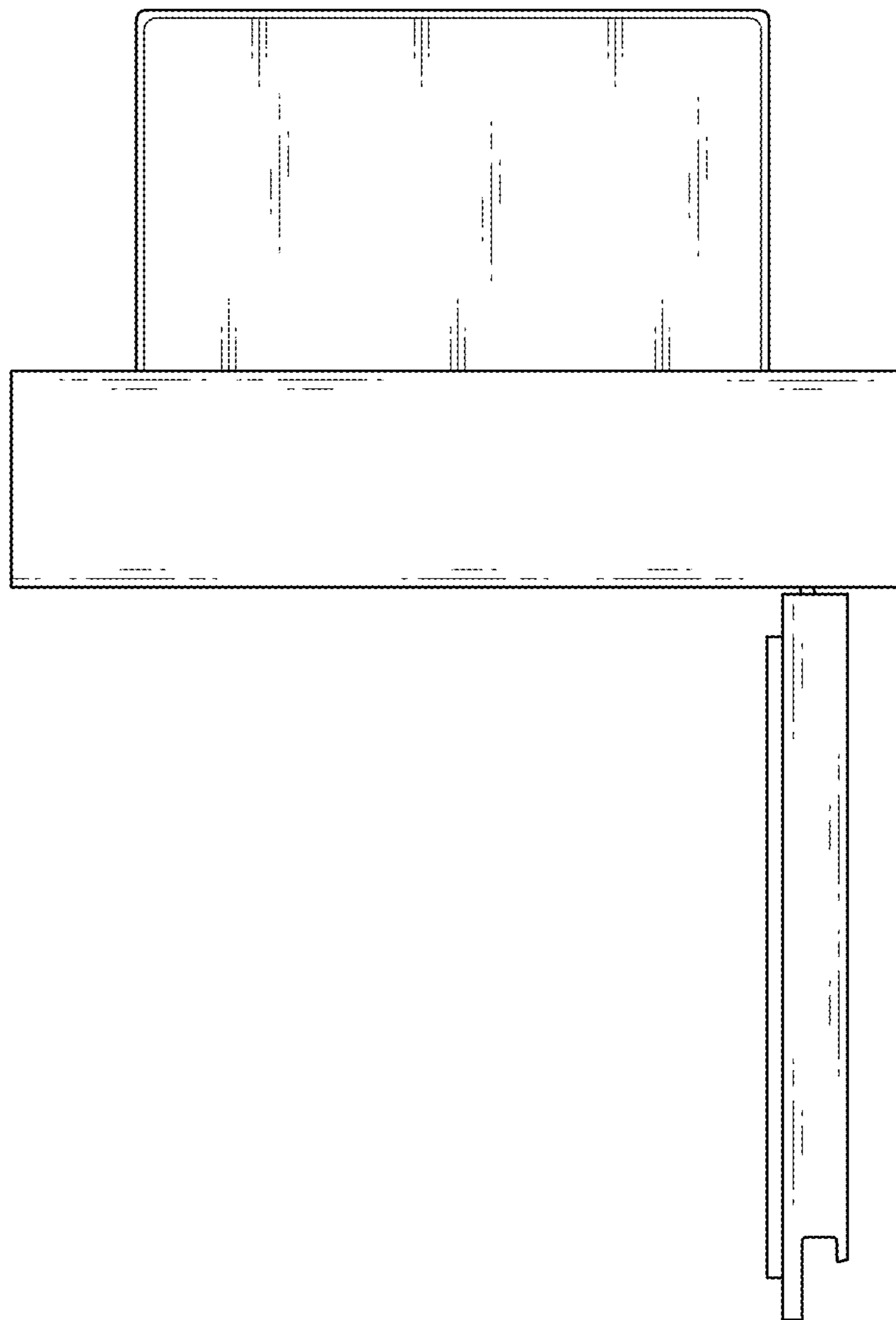

FIG. 12

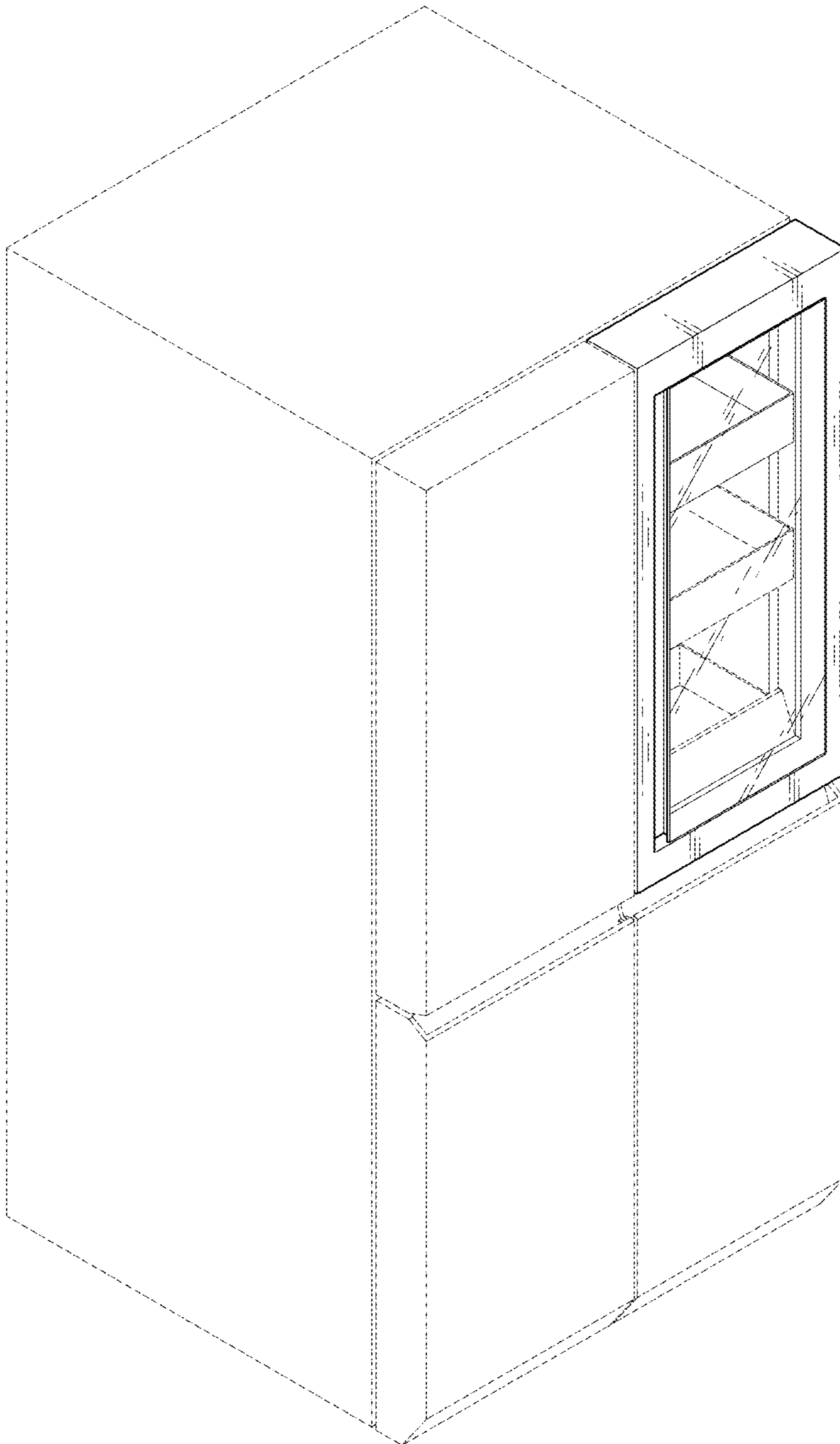

FIG. 13

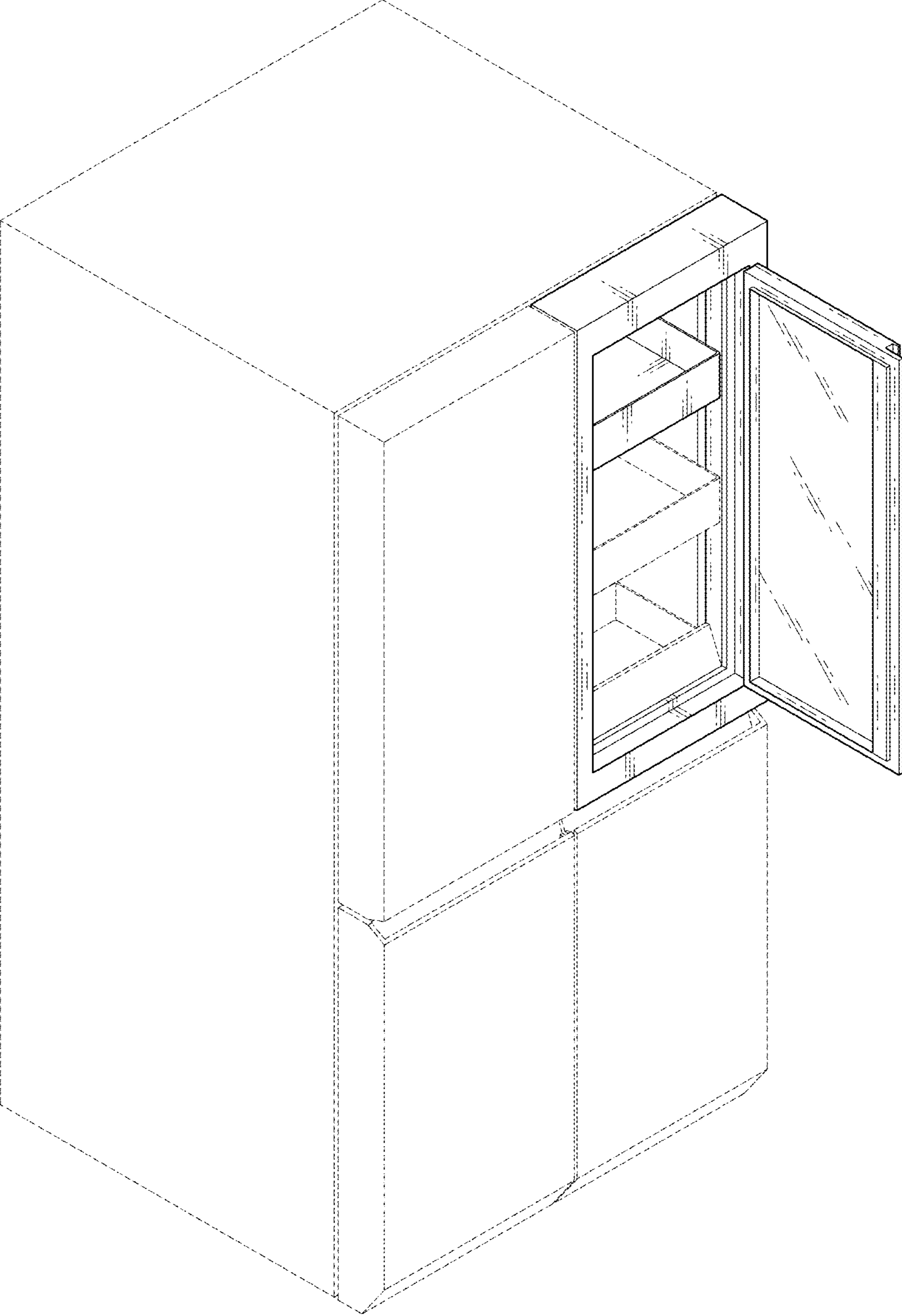

FIG. 14

