

US00D768596S

(12) **United States Design Patent** (10) **Patent No.:** **US D768,596 S**  
**Covello et al.** (45) **Date of Patent:** **\*\* Oct. 11, 2016**

(54) **MEDIA PLAYER**

(71) Applicants: **Pietro V. Covello**, Greenwich, CT (US); **Salvatore P. Covello**, Greenwich, CT (US)

(72) Inventors: **Pietro V. Covello**, Greenwich, CT (US); **Salvatore P. Covello**, Greenwich, CT (US)

(\*\*) Term: **14 Years**

(21) Appl. No.: **29/524,360**

(22) Filed: **Apr. 20, 2015**

(51) **LOC (10) Cl.** ..... **14-03**

(52) **U.S. Cl.**  
USPC ..... **D14/203.1**; D14/496

(58) **Field of Classification Search**  
USPC ..... D14/496, 401, 435, 474, 483, 217, 137, D14/138, 160, 168, 356, 203.1-203.8, 507, D14/341; 345/156, 169, 173-179, 905; 715/727-729, 864; 710/1, 5, 8; 713/1, 713/600; 455/1.1, 1.7, 73, 344-347, 93, 95, 455/3.01-3.06, 550.1, 573.1; 370/342-344; 369/1, 2, 6-12; 463/43-47; 273/148 B; D10/30, 31, 38, 128  
CPC ..... H04J 11/00; H04J 13/00; H04J 14/00  
See application file for complete search history.

(56) **References Cited**

**U.S. PATENT DOCUMENTS**

5,588,253	A *	12/1996	Boodley	.....	A01G 5/04
					428/3
D488,799	S *	4/2004	Moore	.....	D14/188
6,945,003	B2 *	9/2005	Berry	.....	E04B 1/34
					52/638
D540,817	S *	4/2007	Milstein	.....	D14/203.2
D617,768	S *	6/2010	Taghva	.....	D14/203.2
9,161,149	B2 *	10/2015	Visser	.....	G10L 19/00
9,237,485	B2 *	1/2016	Klingenbrunn	...	H04W 36/0022
9,244,501	B2 *	1/2016	Graham	.....	H02J 7/0044
9,252,605	B1 *	2/2016	Custon	.....	H02J 7/0027

\* cited by examiner

*Primary Examiner* — Prabhakar Deshmukh

(74) *Attorney, Agent, or Firm* — St. Onge Steward Johnston & Reens LLC

(57) **CLAIM**

The ornamental design for a media player, as shown and described.

**DESCRIPTION**

FIG. 1 is a front right side perspective view of a media player in accordance with the new design showing the media player in an open position;  
 FIG. 2 is a rear left side perspective view thereof showing the media player in an open position;  
 FIG. 3 is a front elevational view thereof showing the media player in an open position;  
 FIG. 4 is a rear elevational view thereof showing the media player in an open position;  
 FIG. 5 is a right side elevational view thereof showing the media player in an open position, the left side elevation view being a mirror image thereof;  
 FIG. 6 is a top plan view thereof showing the media player in an open position;  
 FIG. 7 is a bottom plan view thereof showing the media player in an open position;  
 FIG. 8 is a front perspective view thereof showing the media player in a closed position;  
 FIG. 9 is a rear perspective view thereof showing the media player in a closed position;  
 FIG. 10 is a front elevational view thereof showing the media player in a closed position;  
 FIG. 11 is a rear elevational view thereof showing the media player in a closed position;  
 FIG. 12 is a right side elevational view thereof showing the media player in a closed position, the left side elevational view being a mirror image thereof;  
 FIG. 13 is a top plan view thereof showing the media player in a closed position; and,  
 FIG. 14 is a bottom plan view thereof showing the media player in a closed position.  
 The broken lines shown in FIGS. 1-14 are for illustrative purposes only and form no part of the claimed design.

**1 Claim, 14 Drawing Sheets**

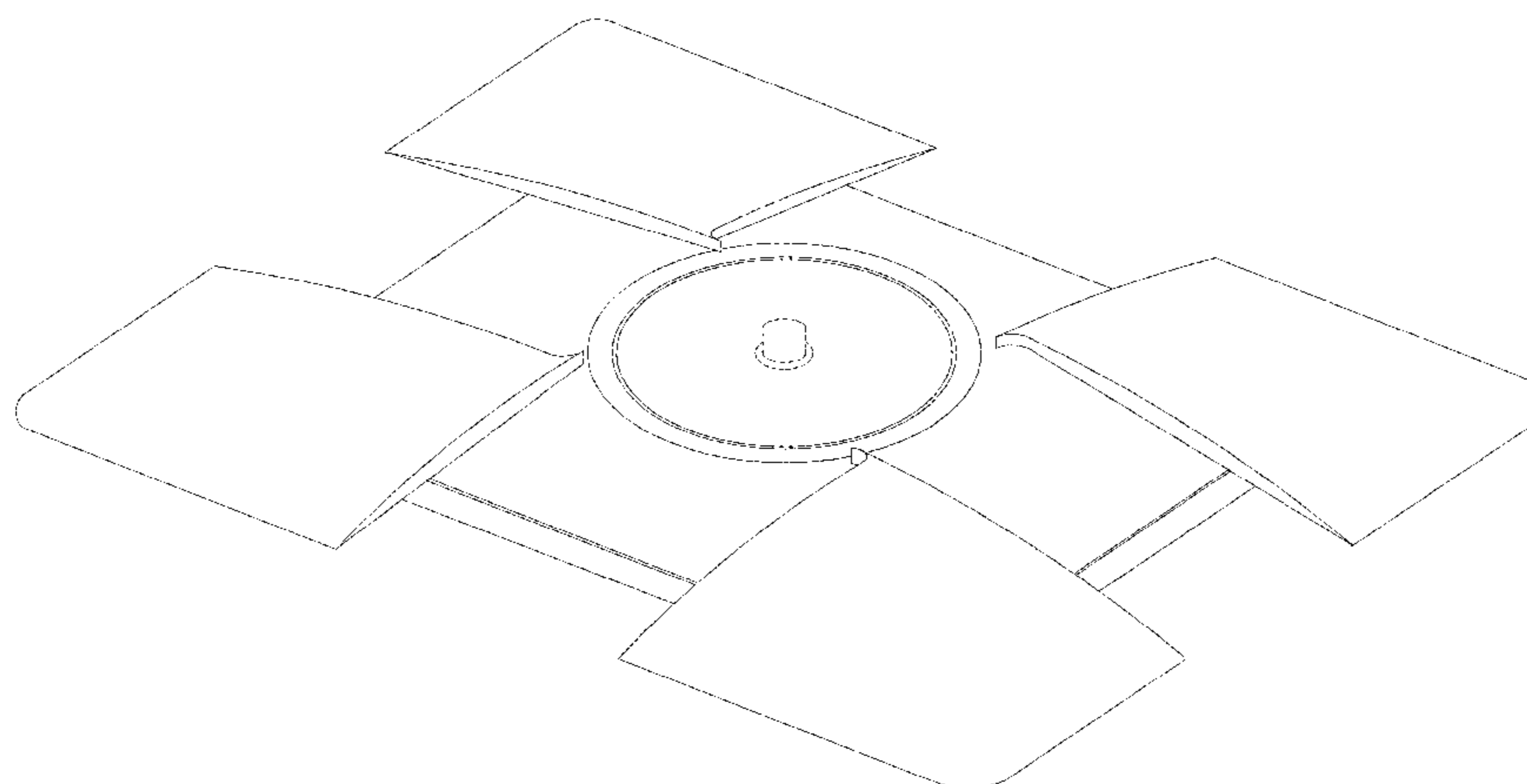

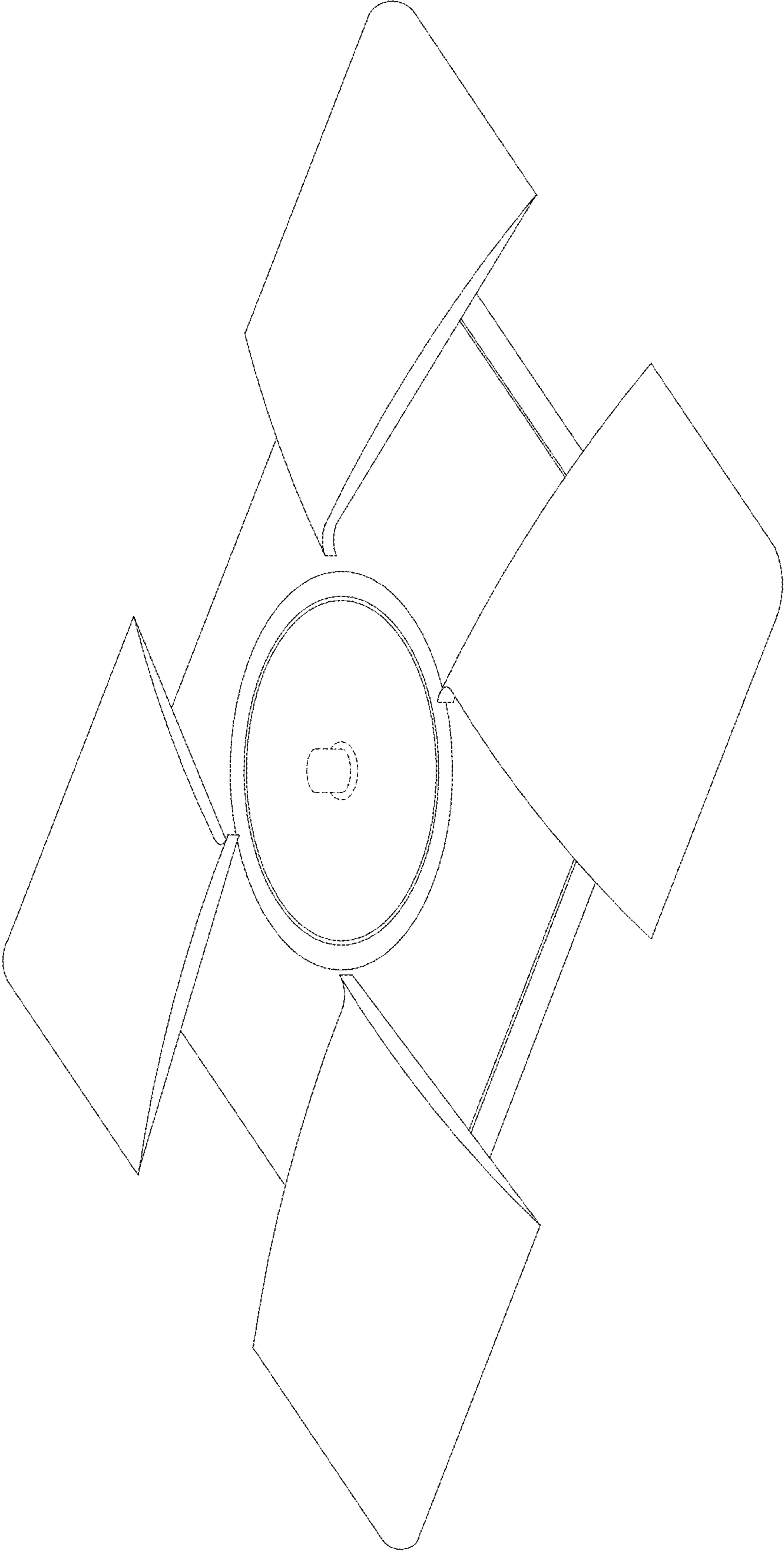

FIG. 1

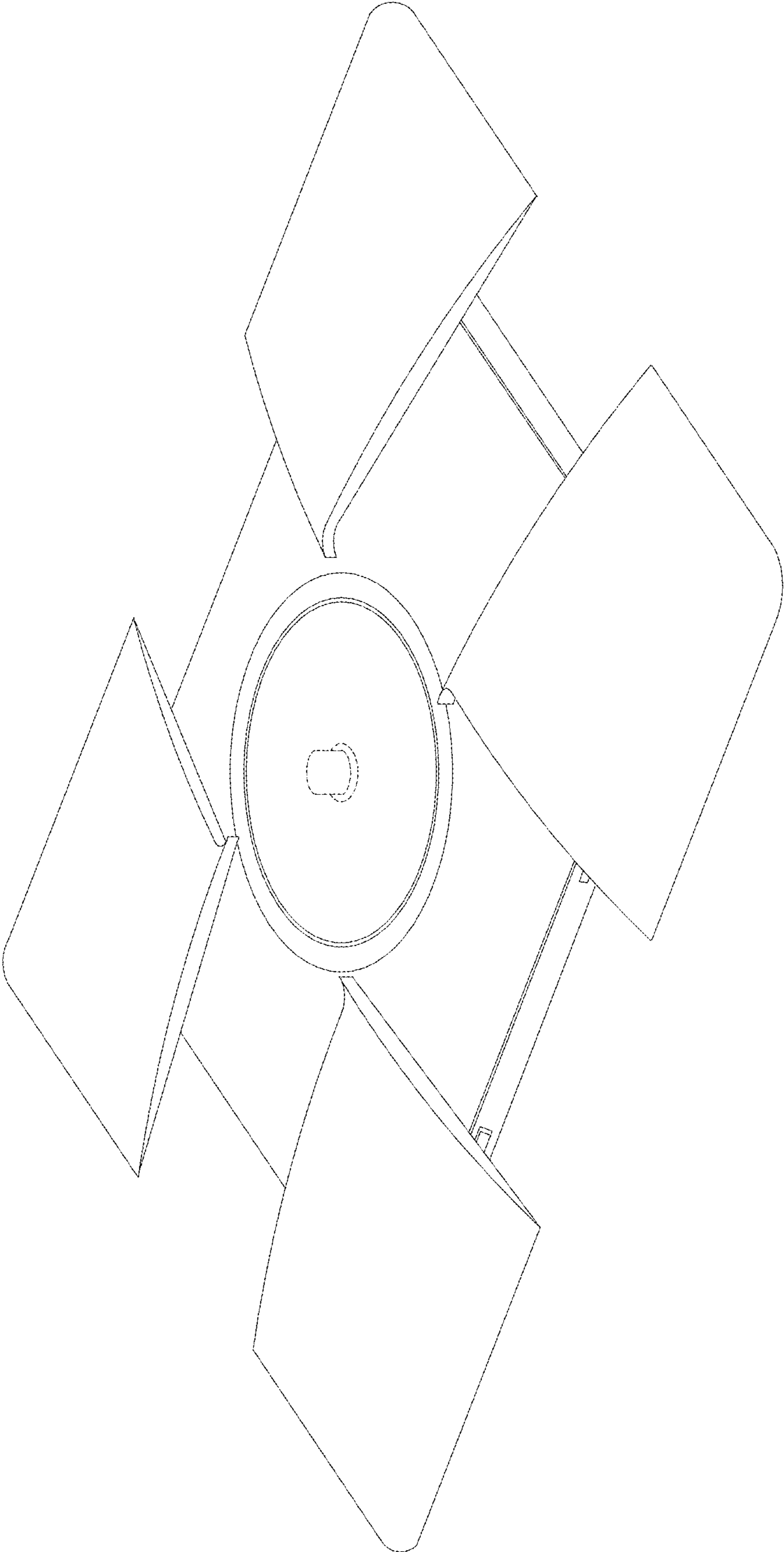

FIG. 2

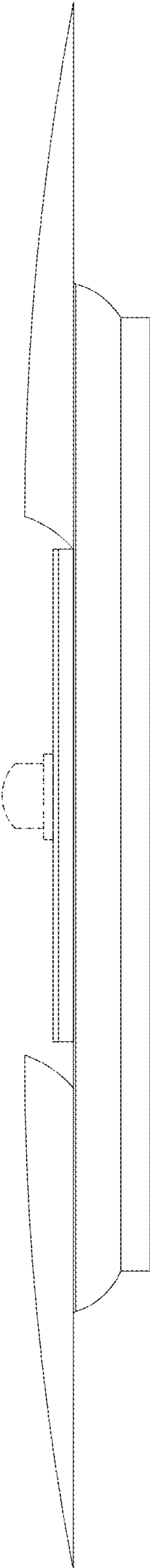

FIG. 3

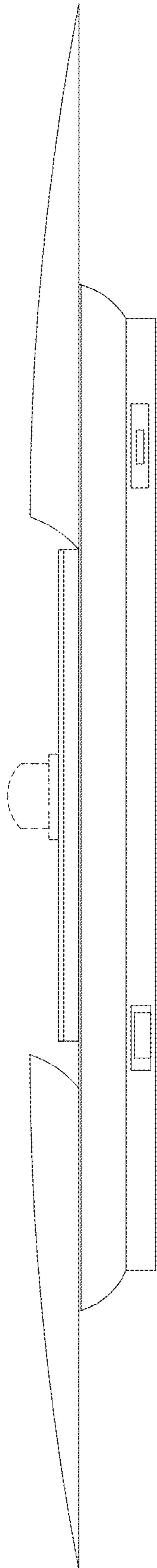

FIG. 4

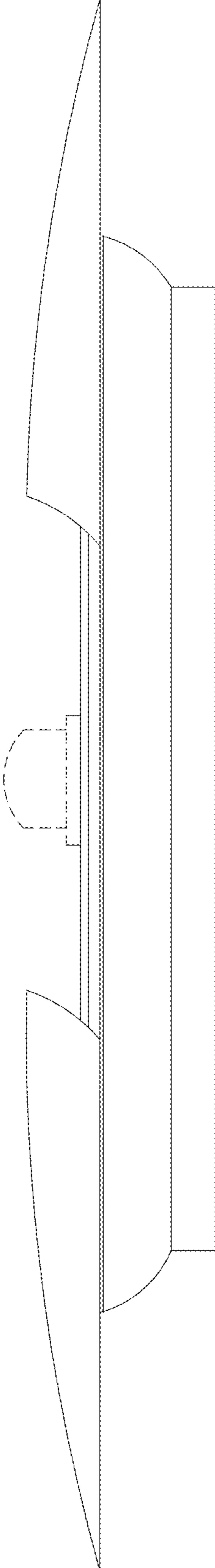

FIG. 5

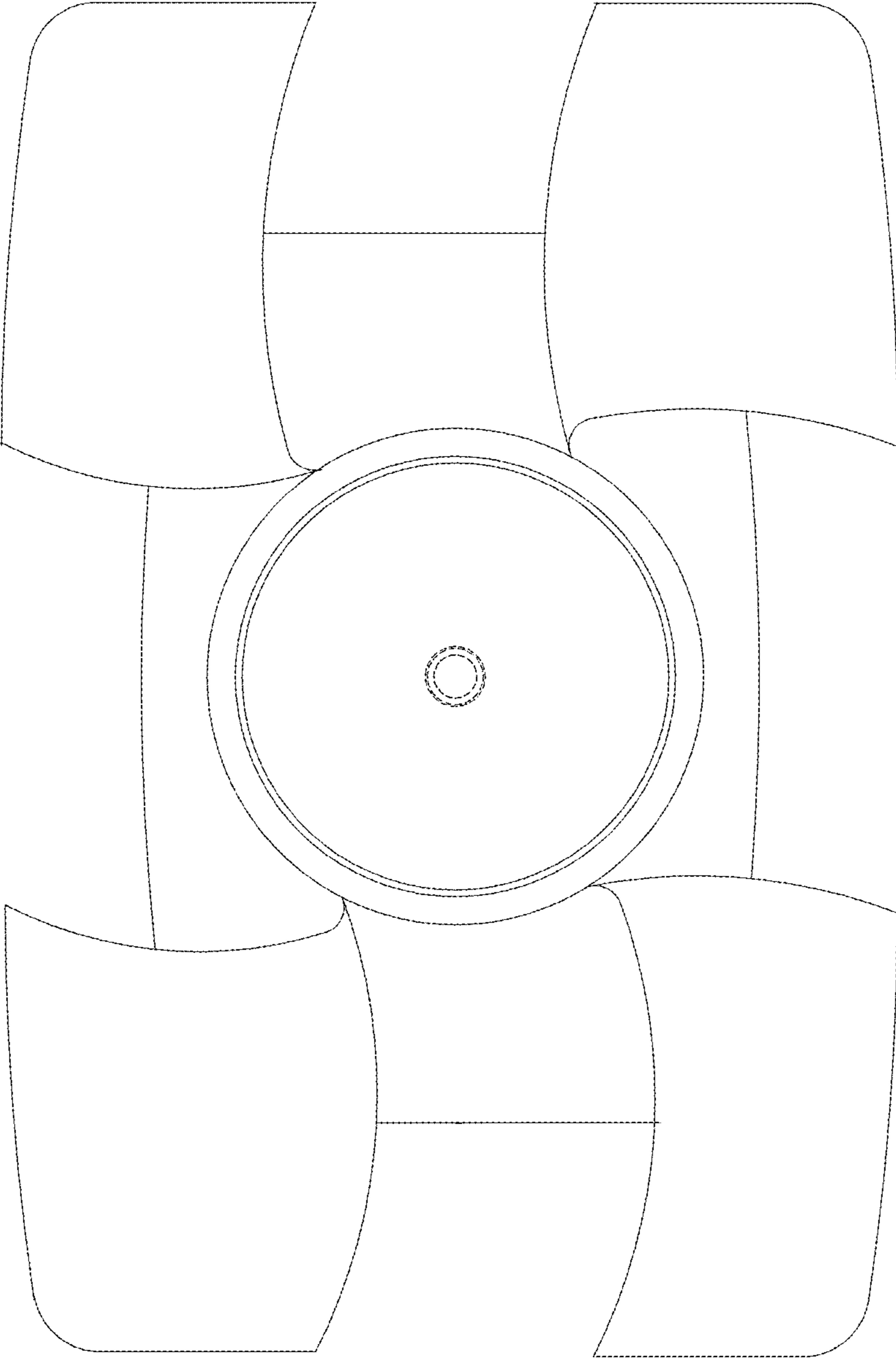

FIG. 6

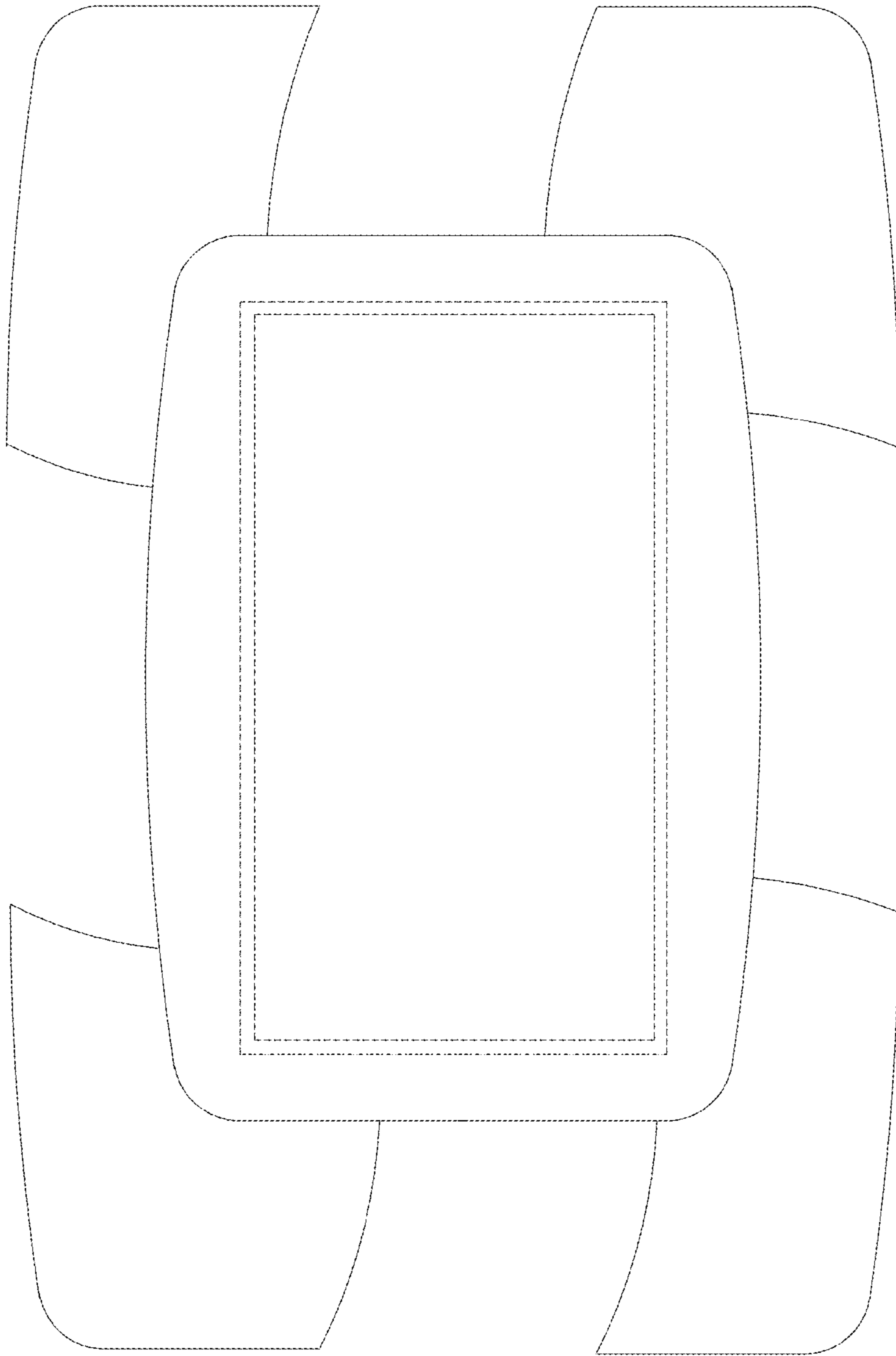

FIG. 7



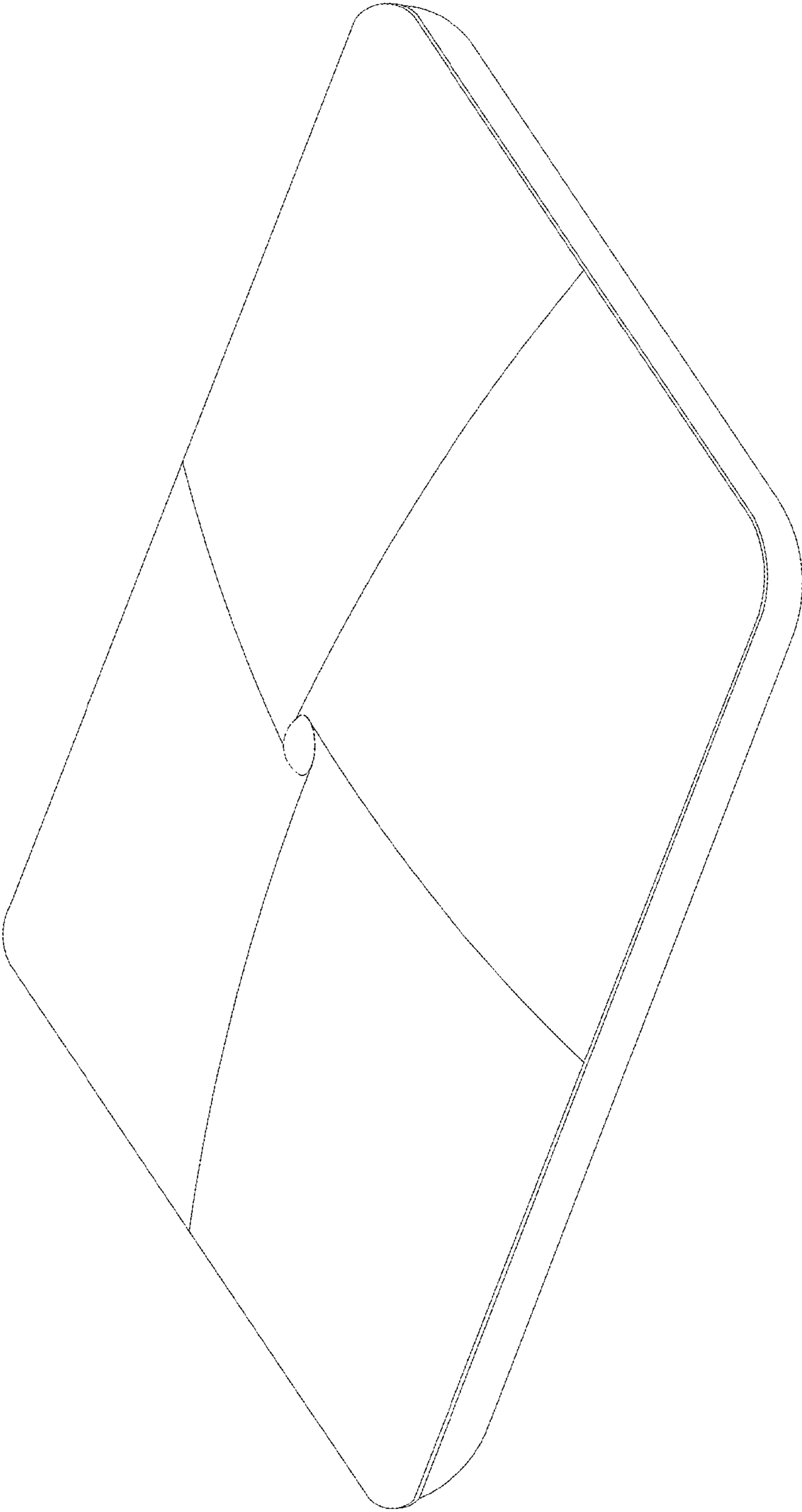

FIG. 8

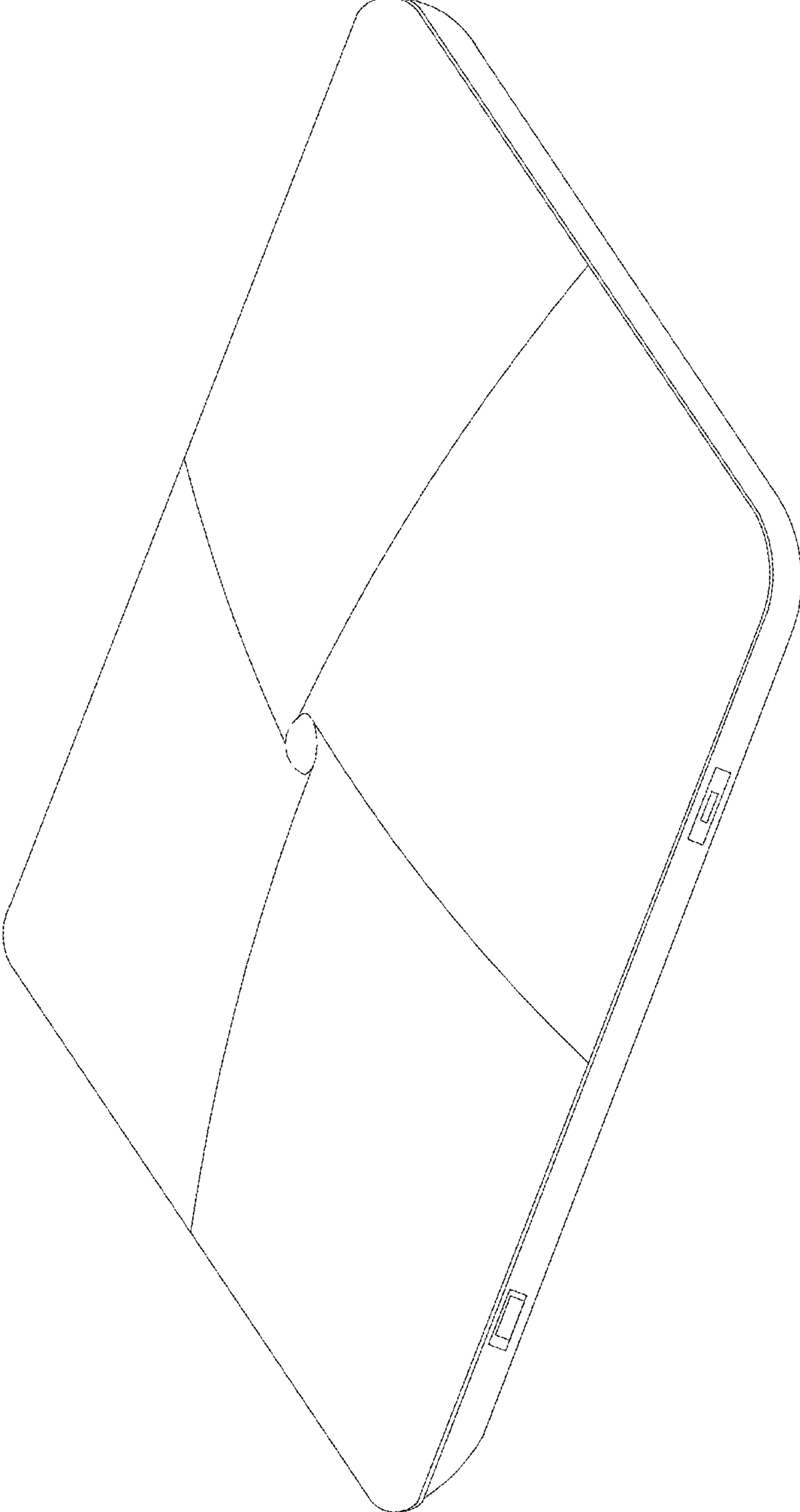

FIG. 9

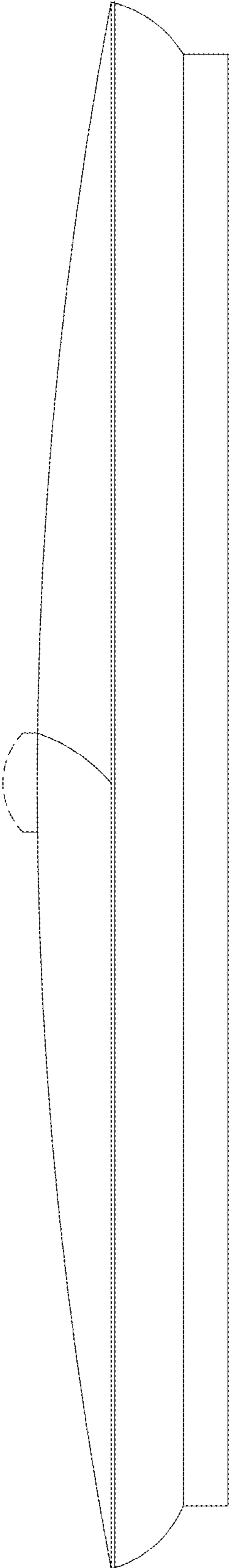

FIG. 10

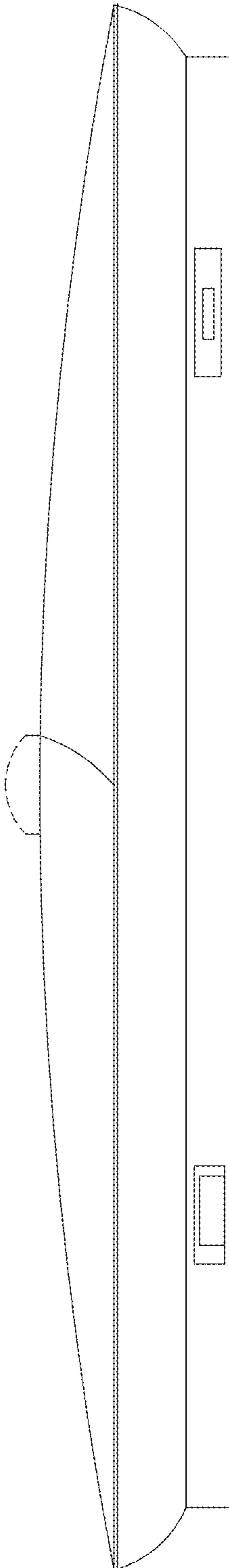

FIG. 11

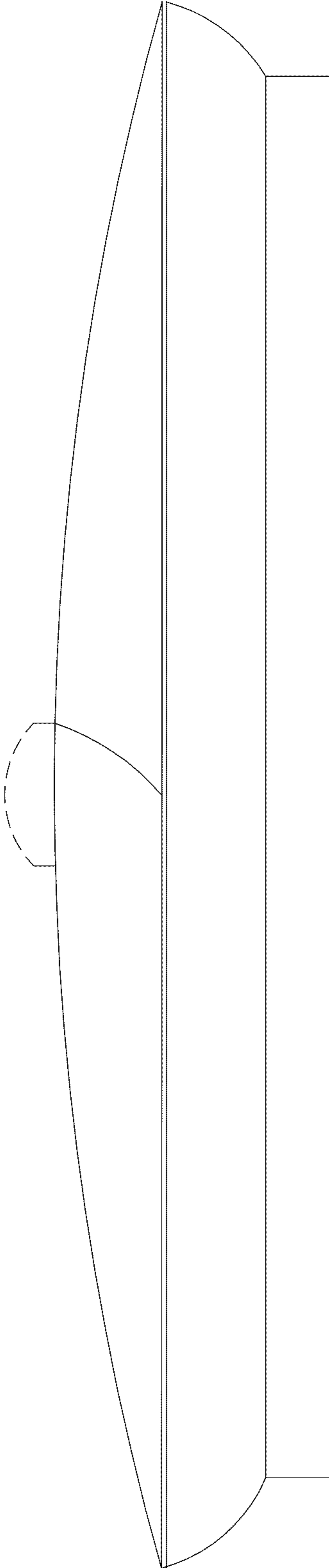

FIG. 12

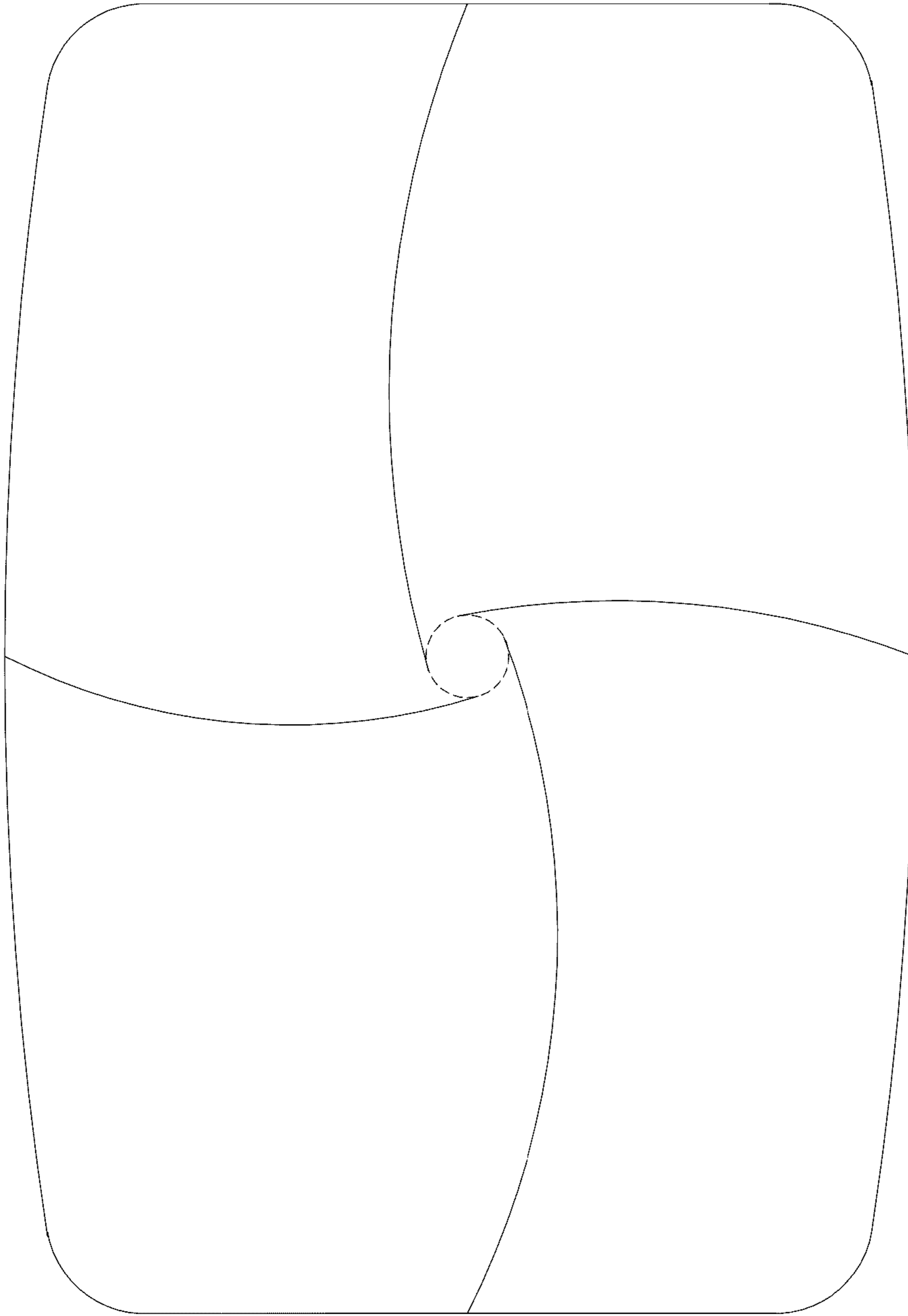

FIG. 13

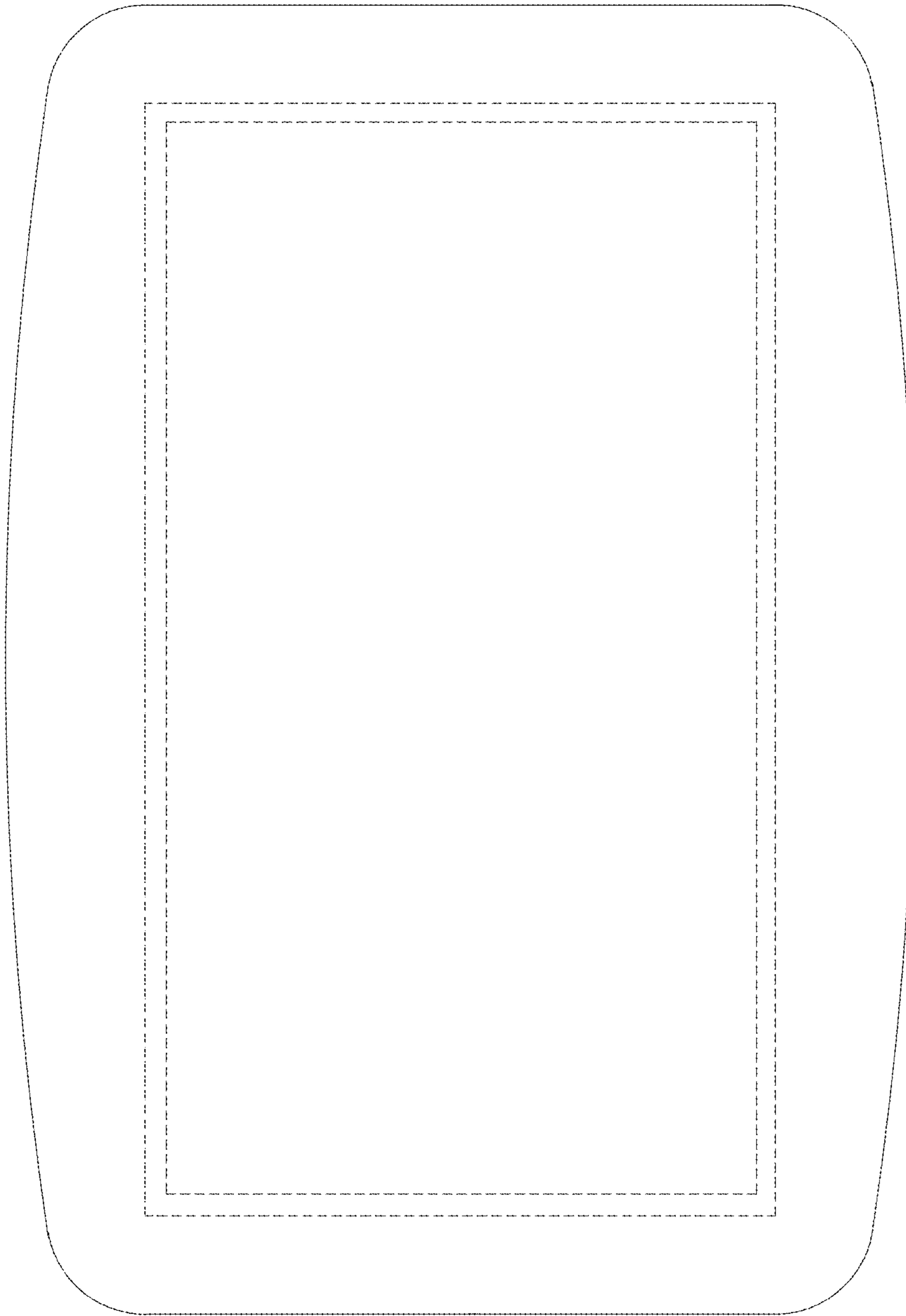

FIG. 14