

US00D768579S

(12) **United States Design Patent**
Chen et al.

(10) **Patent No.:** **US D768,579 S**

(45) **Date of Patent:** **** *Oct. 11, 2016**

(54) **APPARATUS FOR RECORDING,
TRANSMITTING OR PROCESSING
INFORMATION**

(71) Applicant: **Siemens Aktiengesellschaft**, Munich
(DE)

(72) Inventors: **Chang Sen Chen**, Chengdu (CN); **Jie Yang**, Nanjing (CN); **Yu Hao Zhu**, Nanjing (CN)

(73) Assignee: **Siemens Aktiengesellschaft**, Munich
(DE)

(*) Notice: This patent is subject to a terminal disclaimer.

(**) Term: **14 Years**

(21) Appl. No.: **29/493,808**

(22) Filed: **Jun. 13, 2014**

(30) **Foreign Application Priority Data**

Dec. 16, 2013 (CN) 2013 3 0626719

(51) **LOC (10) Cl.** **13-03**

(52) **U.S. Cl.**
USPC **D13/162.1**

(58) **Field of Classification Search**
USPC D13/162, 162.1; D14/301, 439
CPC ... G05B 19/05; G06F 3/147; G06F 11/3636;
H05K 7/1432; H05K 7/1467; H05K 7/1468;
H05K 7/1474; H05K 7/1478; H05K 7/1481
See application file for complete search history.

(56) **References Cited**

U.S. PATENT DOCUMENTS

D282,253 S * 1/1986 Shimizu D13/164
D287,117 S * 12/1986 Saiki D13/162.1
D290,694 S * 7/1987 Shimizu D13/162.1

5,253,140 A * 10/1993 Inoue H05K 7/1468
16/429
5,984,734 A * 11/1999 Piper H01R 29/00
439/715
D488,133 S * 4/2004 Droulin D13/162.1
6,904,471 B2 * 6/2005 Boggs G06F 11/3636
326/40
D602,445 S * 10/2009 Liu D13/162.1
D692,397 S * 10/2013 Liu D13/162.1
D695,235 S * 12/2013 Liu D13/162.1
D696,634 S * 12/2013 Liu D13/162.1
D702,647 S * 4/2014 Liu D13/162.1
D735,145 S * 7/2015 Liu D13/162.1
D743,351 S * 11/2015 Ringer D13/162
2001/0011597 A1 * 8/2001 Imoto G05B 19/0423
174/50
2012/0109343 A1 * 5/2012 Shah G05B 19/409
700/83

* cited by examiner

Primary Examiner — Selina Sikder

(74) *Attorney, Agent, or Firm* — Cozen O'Connor

(57) **CLAIM**

The ornamental design for an apparatus for recording, transmitting or processing information, as shown and described.

DESCRIPTION

FIG. 1 is a front elevational view of an apparatus for recording, transmitting or processing information showing our new design;

FIG. 2 is a rear elevational view thereof;

FIG. 3 is a top plan view thereof;

FIG. 4 is a bottom plan view thereof;

FIG. 5 is a right-side elevation view thereof;

FIG. 6 is left-side elevation view thereof; and,

FIG. 7 is a front, bottom and right-side perspective view thereof.

The broken line portion of the figure drawings is included to show unclaimed subject matter only and forms no part of the claimed design.

1 Claim, 7 Drawing Sheets

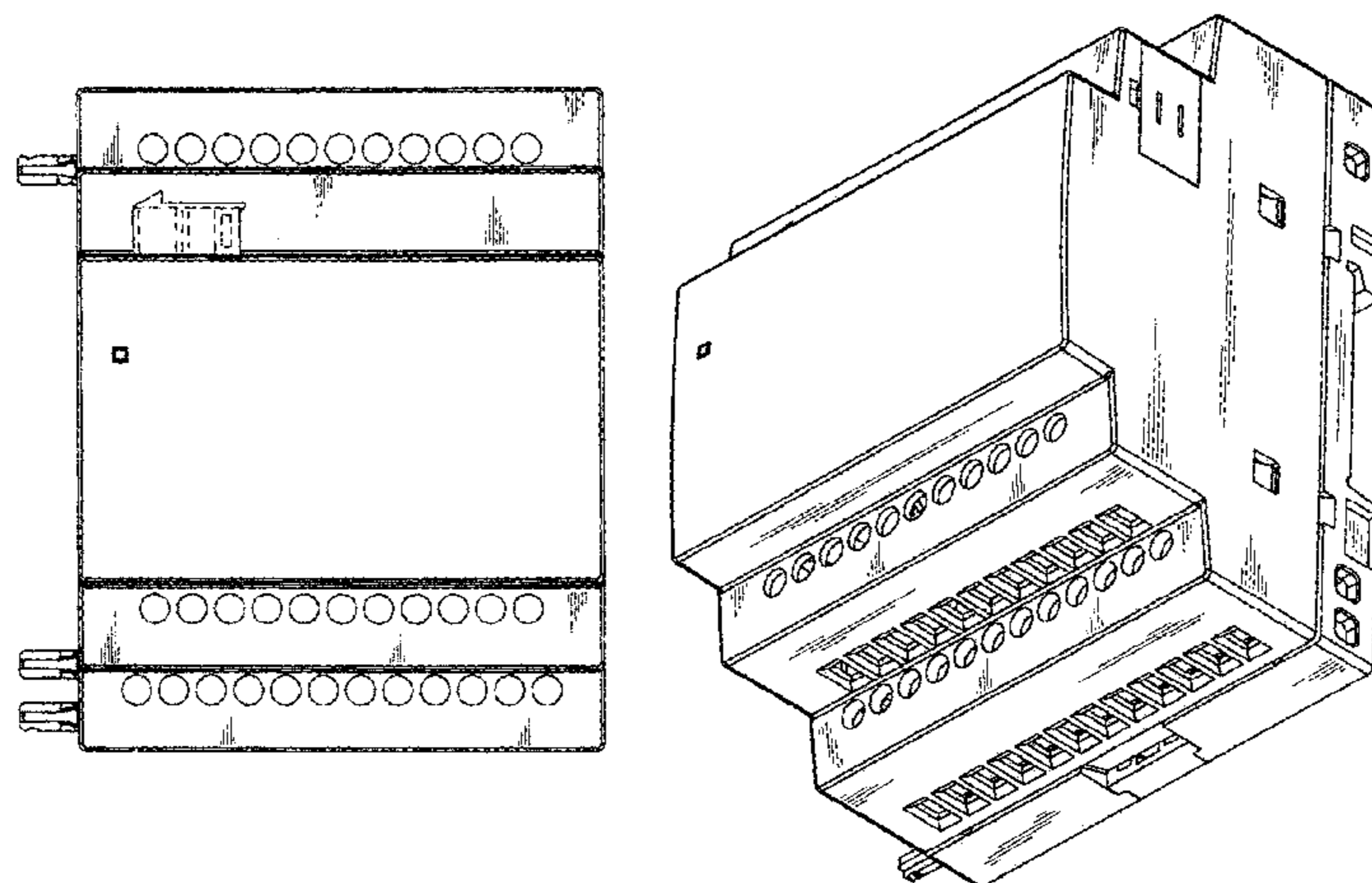

FIG 1

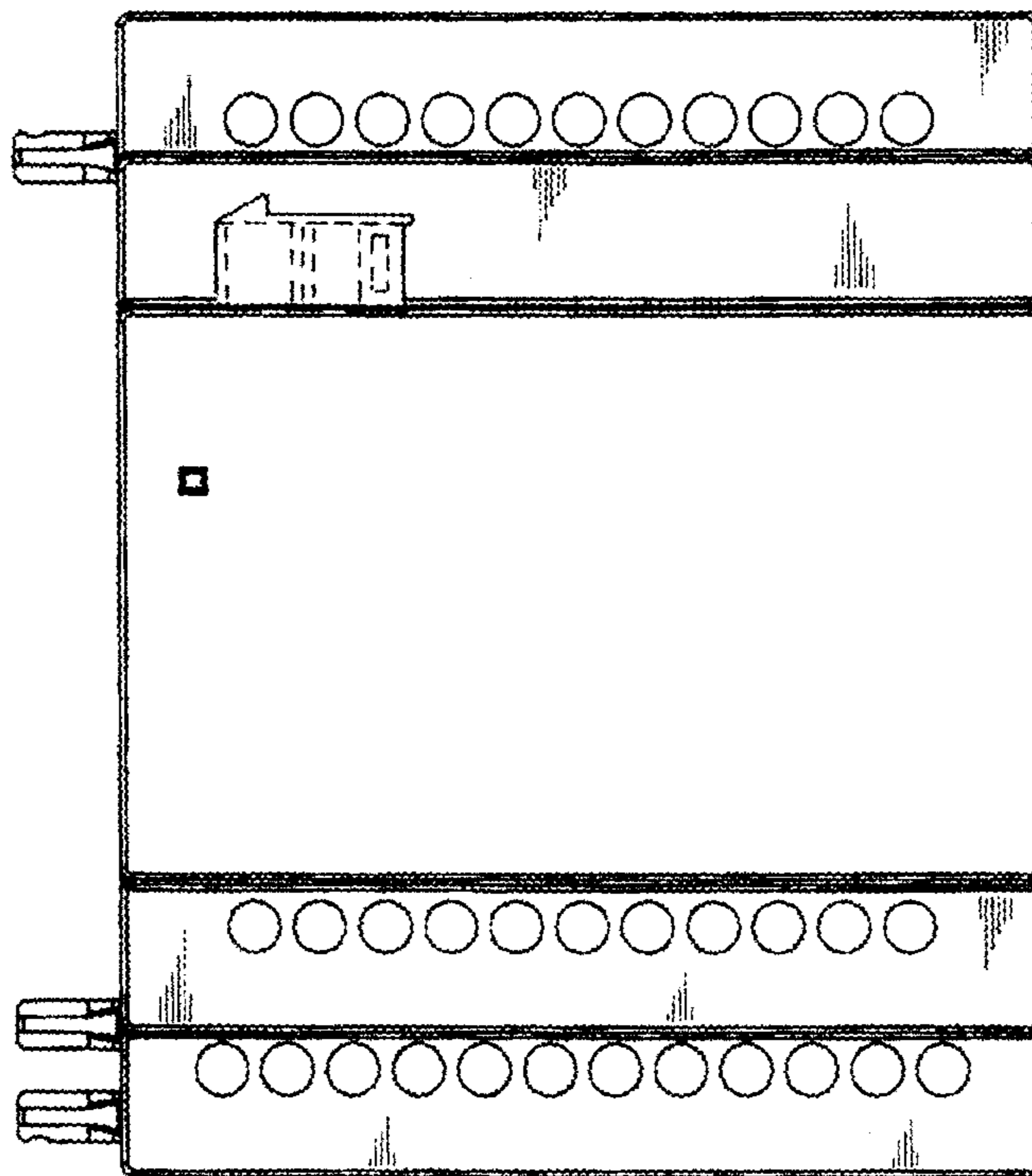

FIG 2

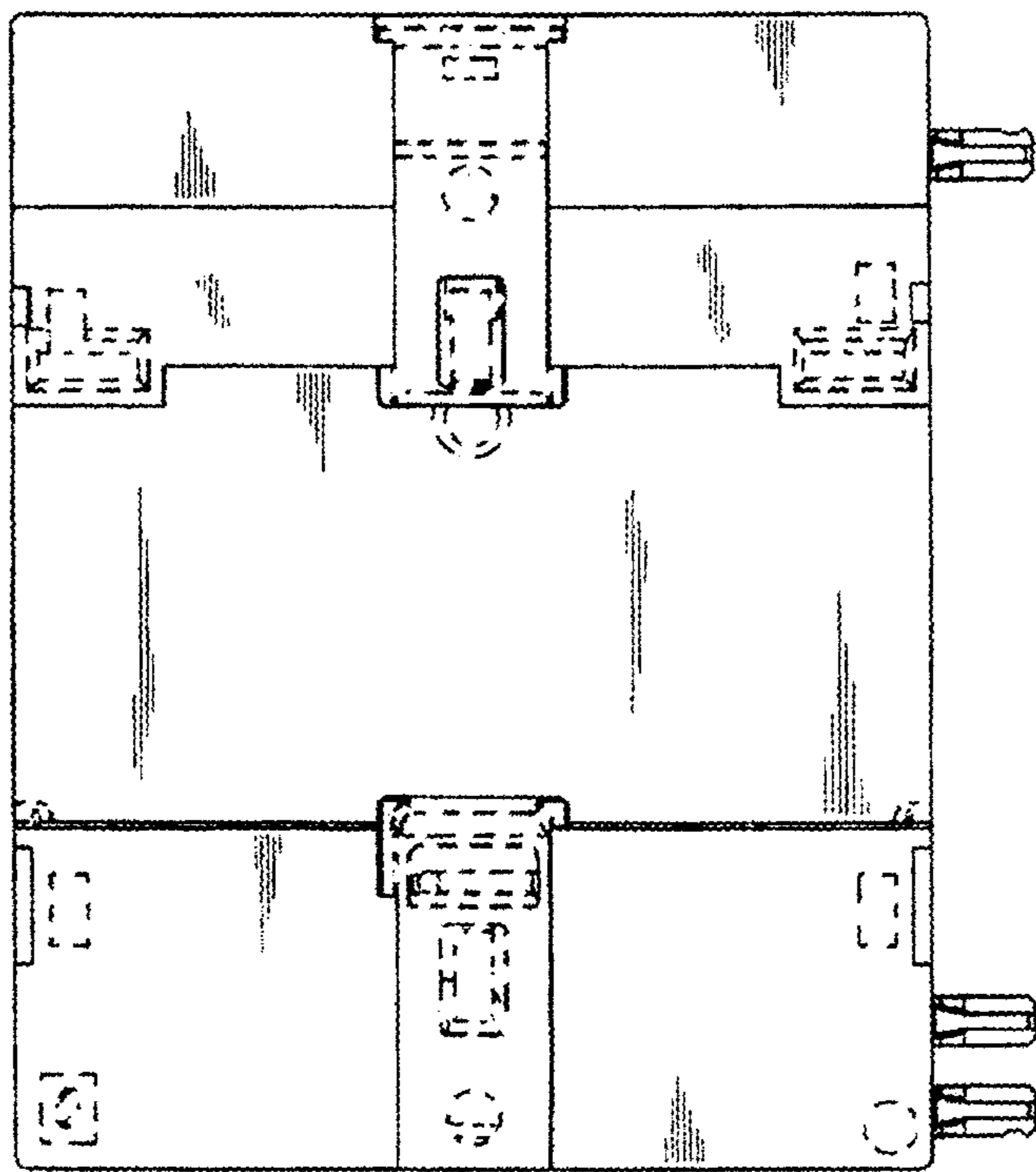

FIG 3

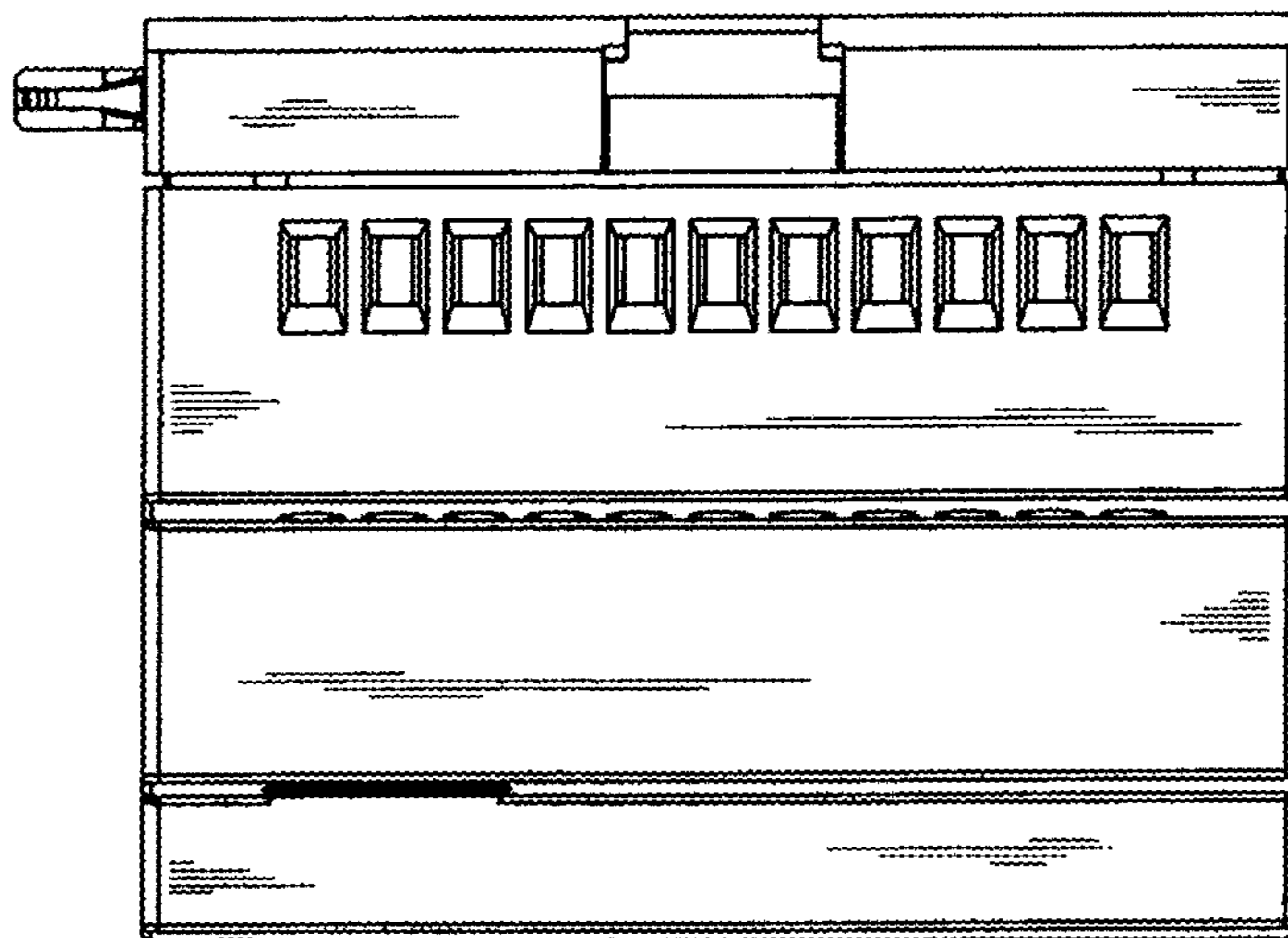

FIG 4

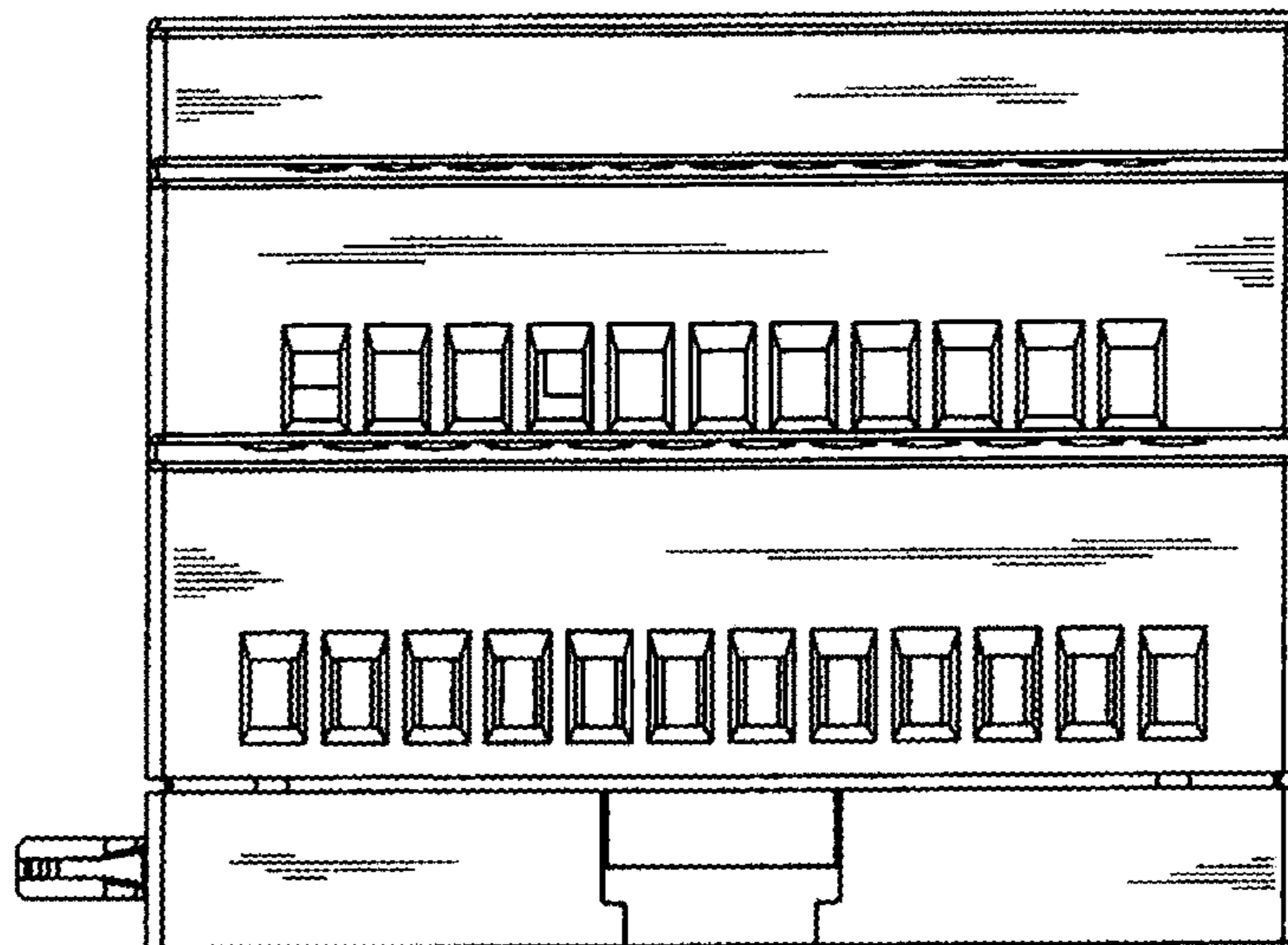

FIG 5

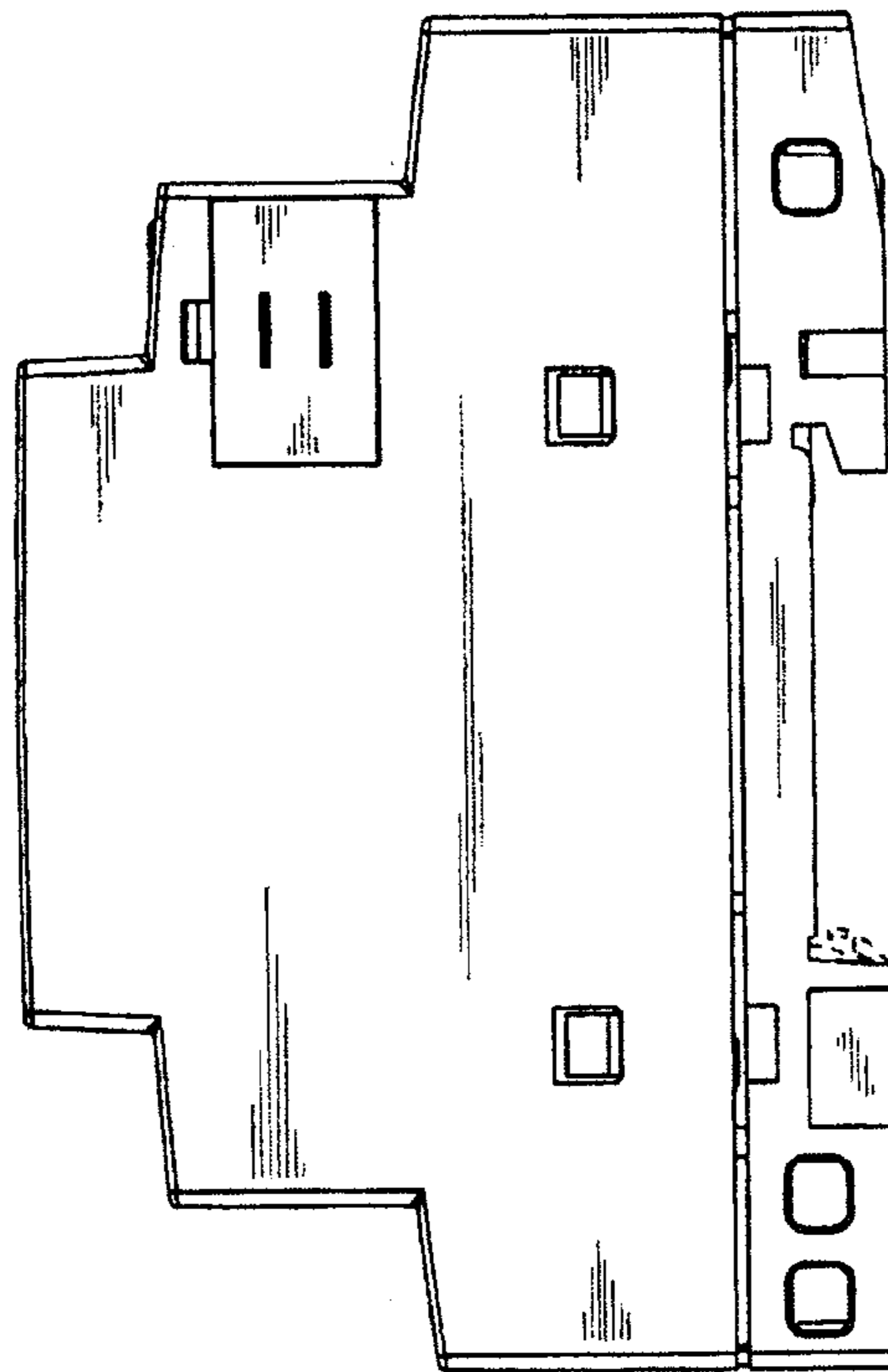

FIG 6

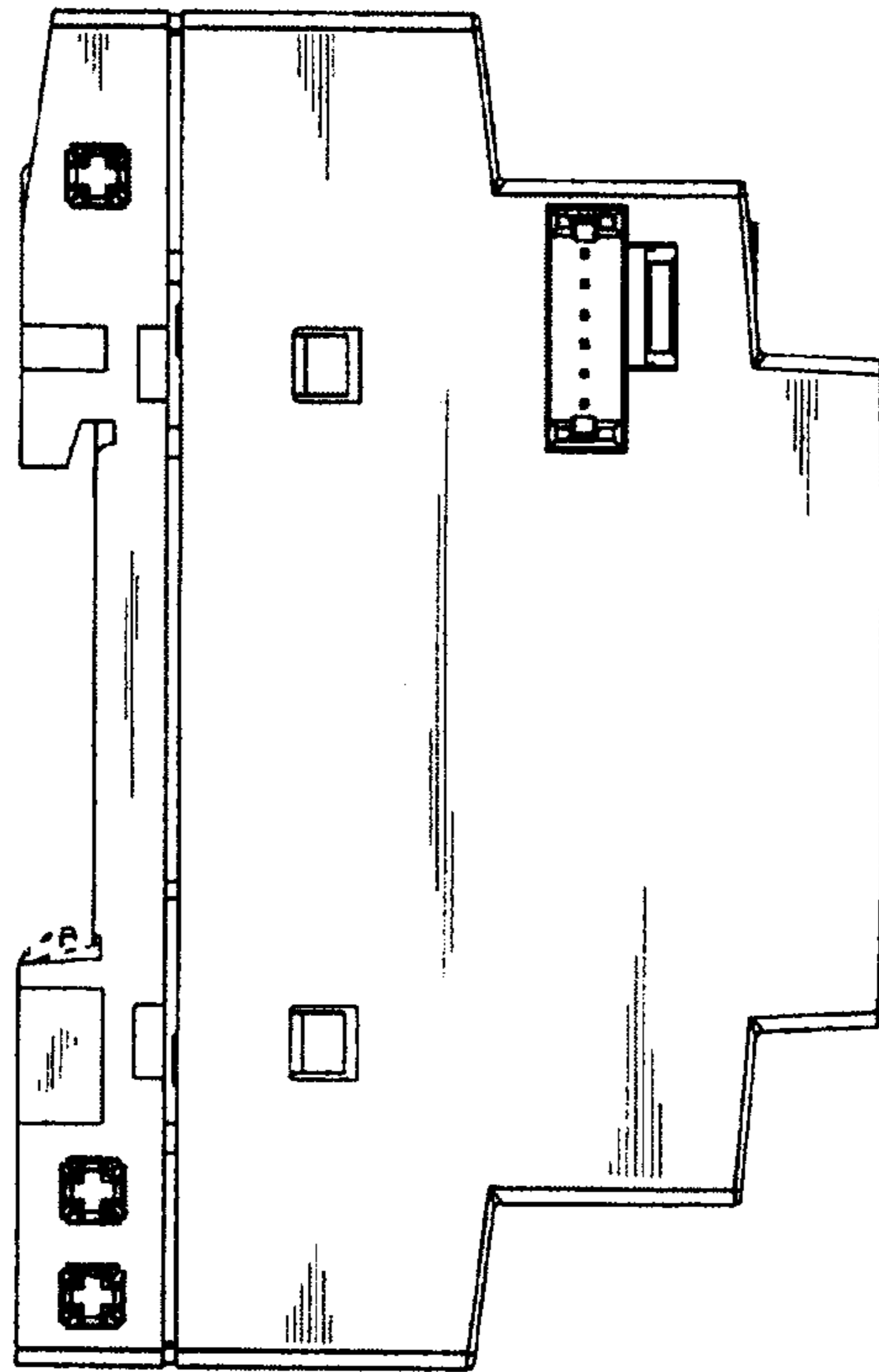

FIG 7

