



US00D768541S

(12) **United States Design Patent**
Burki et al.

(10) **Patent No.:** **US D768,541 S**

(45) **Date of Patent:** **** Oct. 11, 2016**

(54) **VEHICLE, TOY, AND/OR REPLICAS THEREOF**

(71) Applicant: **Daimler AG**, Stuttgart (DE)

(72) Inventors: **Emiel Burki**, Stuttgart (DE);
Hans-Dieter Futschik, Gechingen (DE); **Michael Gebhardt**, Stuttgart (DE); **Gorden Wagener**, Gaeufelden (DE)

(73) Assignee: **Daimler AG**, Stuttgart (DE)

(**) Term: **14 Years**

(21) Appl. No.: **29/525,338**

(22) Filed: **Apr. 29, 2015**

(30) **Foreign Application Priority Data**

Oct. 31, 2014 (WO) DM/084845

(51) **LOC (10) Cl.** **12-08**

(52) **U.S. Cl.**
USPC **D12/90**

(58) **Field of Classification Search**
USPC D12/86, 90-92, 88; D21/421, 433, 434;
296/181.1, 181.5
CPC B62D 35/00; B62D 25/00; B62D 25/06;
B62D 33/00
See application file for complete search history.

(56) **References Cited**

U.S. PATENT DOCUMENTS

D559,734 S 1/2008 Sinkwitz
D660,747 S * 5/2012 Koehl D12/90

D684,091 S * 6/2013 Frenzel D12/90
D693,271 S * 11/2013 Burki D12/90
D693,272 S * 11/2013 Burki D12/90
D696,606 S * 12/2013 Dong D12/90
D731,360 S * 6/2015 Burki D12/91
D731,361 S * 6/2015 Burki D12/91
D736,682 S * 8/2015 Burki D12/163
D740,724 S * 10/2015 Burki D12/163

* cited by examiner

Primary Examiner — Melody N Brown

(74) *Attorney, Agent, or Firm* — Crowell & Moring LLP

(57) **CLAIM**

The ornamental design for a vehicle, toy, and/or replicas thereof, as shown and described.

DESCRIPTION

This application contains subject matter related to the following U.S. design patent application:

Application Ser. No. 29/482,596, filed Feb. 20, 2014 and entitled "Vehicle, Toy, and/or Replicas Thereof."

FIG. 1 is a left, front perspective view of a vehicle, toy, and/or replicas thereof according to the design;
FIG. 2 is a right, rear perspective view thereof;
FIG. 3 is a left side view thereof;
FIG. 4 is a right side view thereof;
FIG. 5 is a front view thereof; and,
FIG. 6 is a rear view thereof.

The broken lines are for illustrative purposes only and form no part of the claimed design.

1 Claim, 6 Drawing Sheets

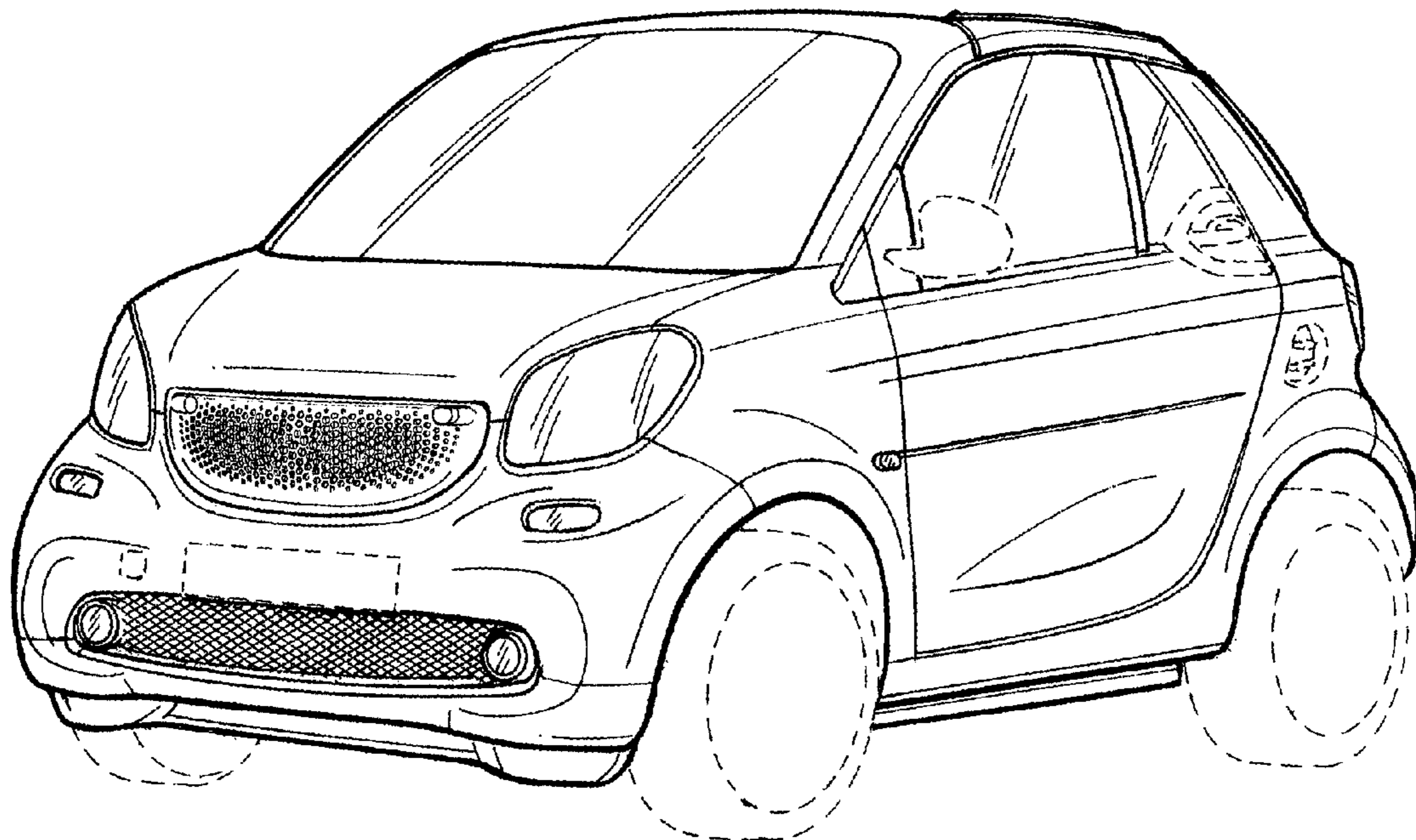

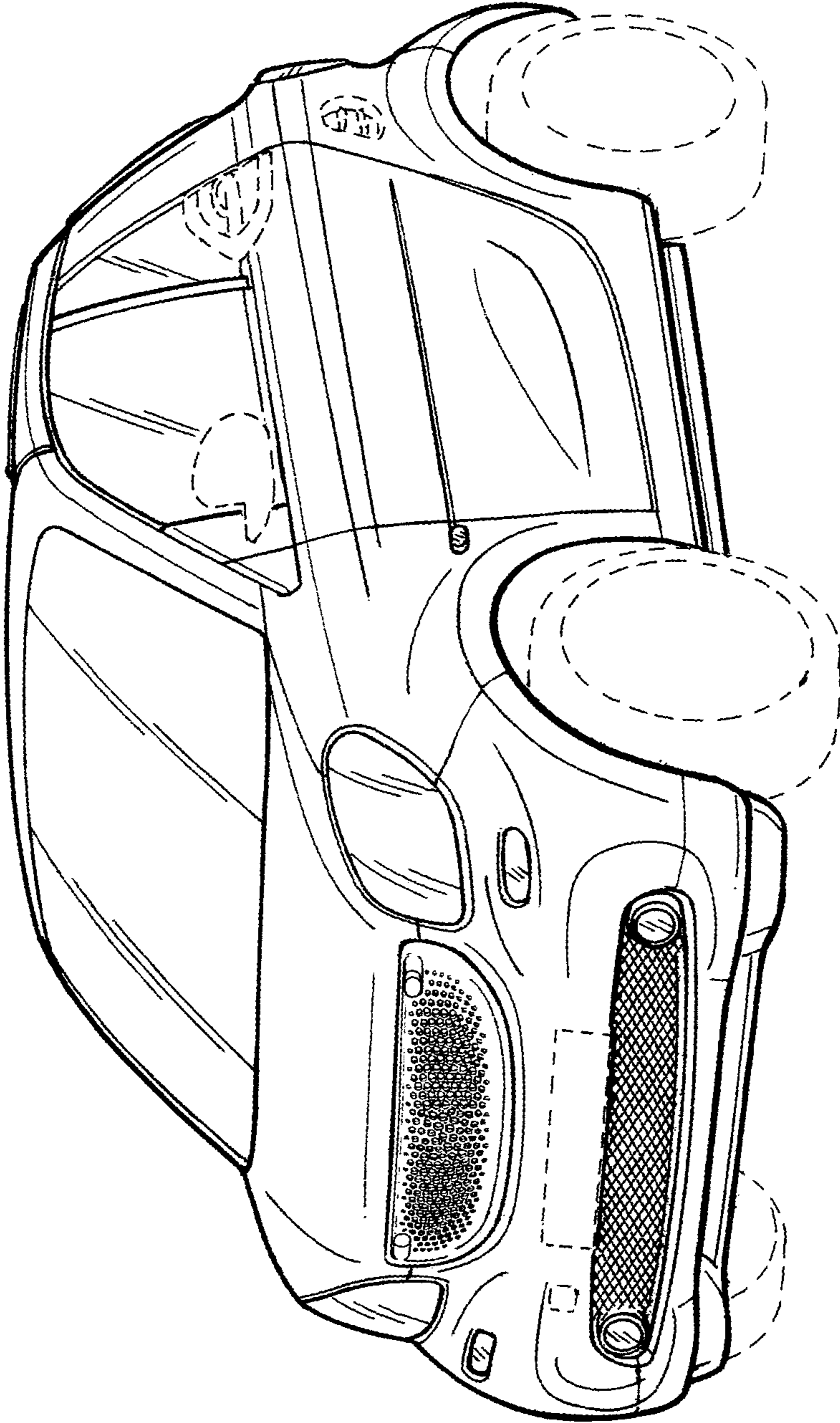

FIG. 1

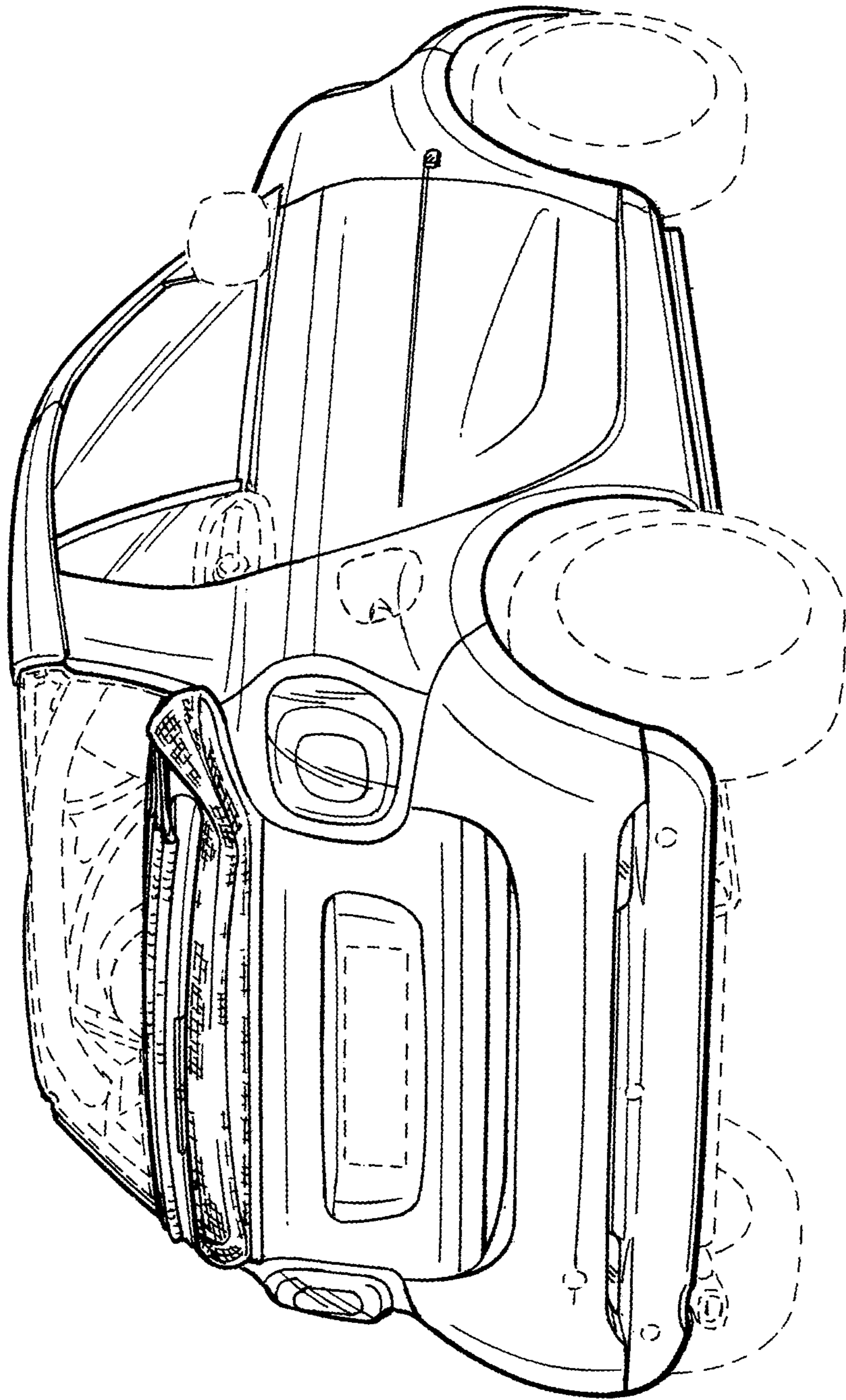

FIG. 2

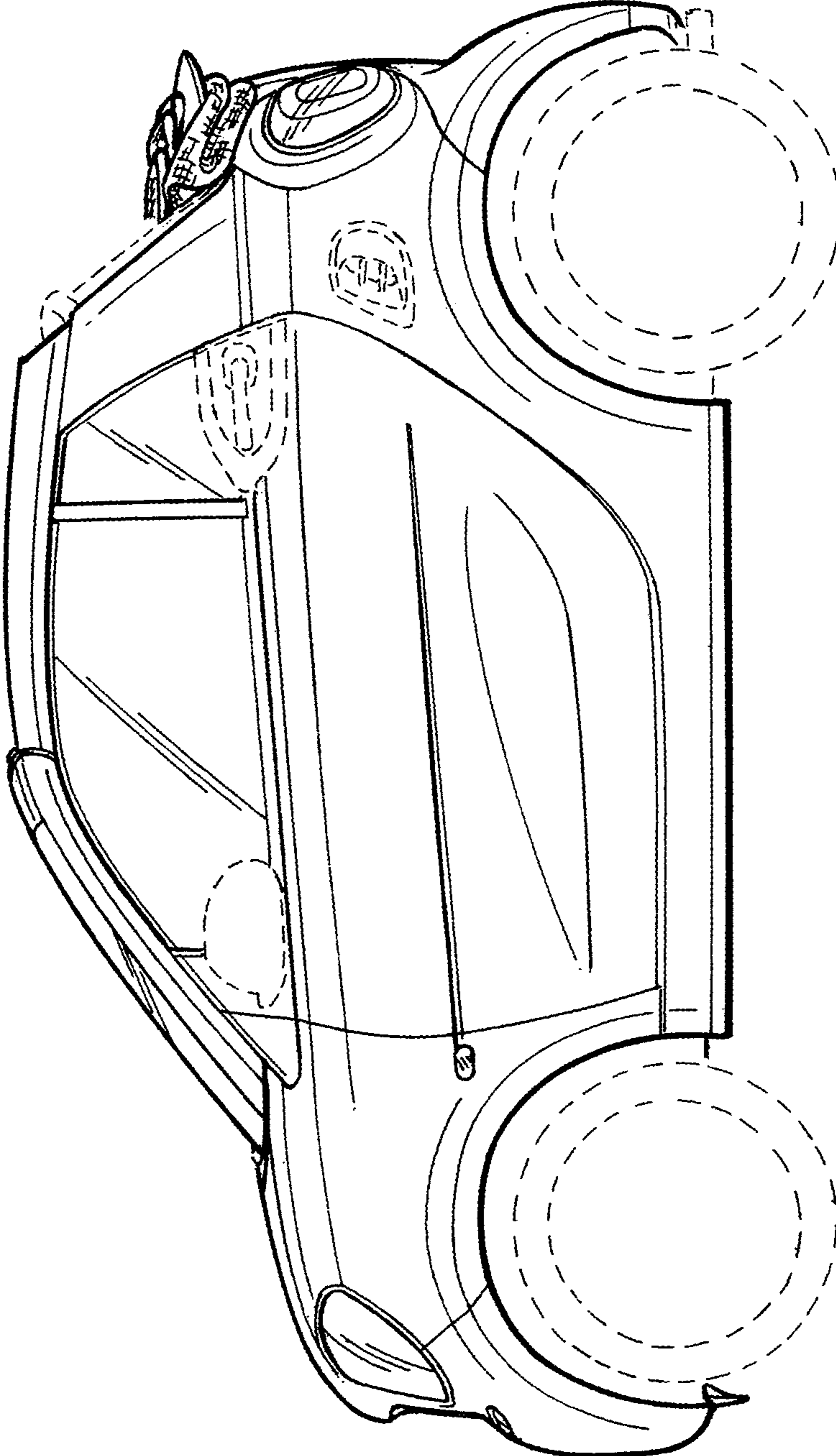

FIG. 3

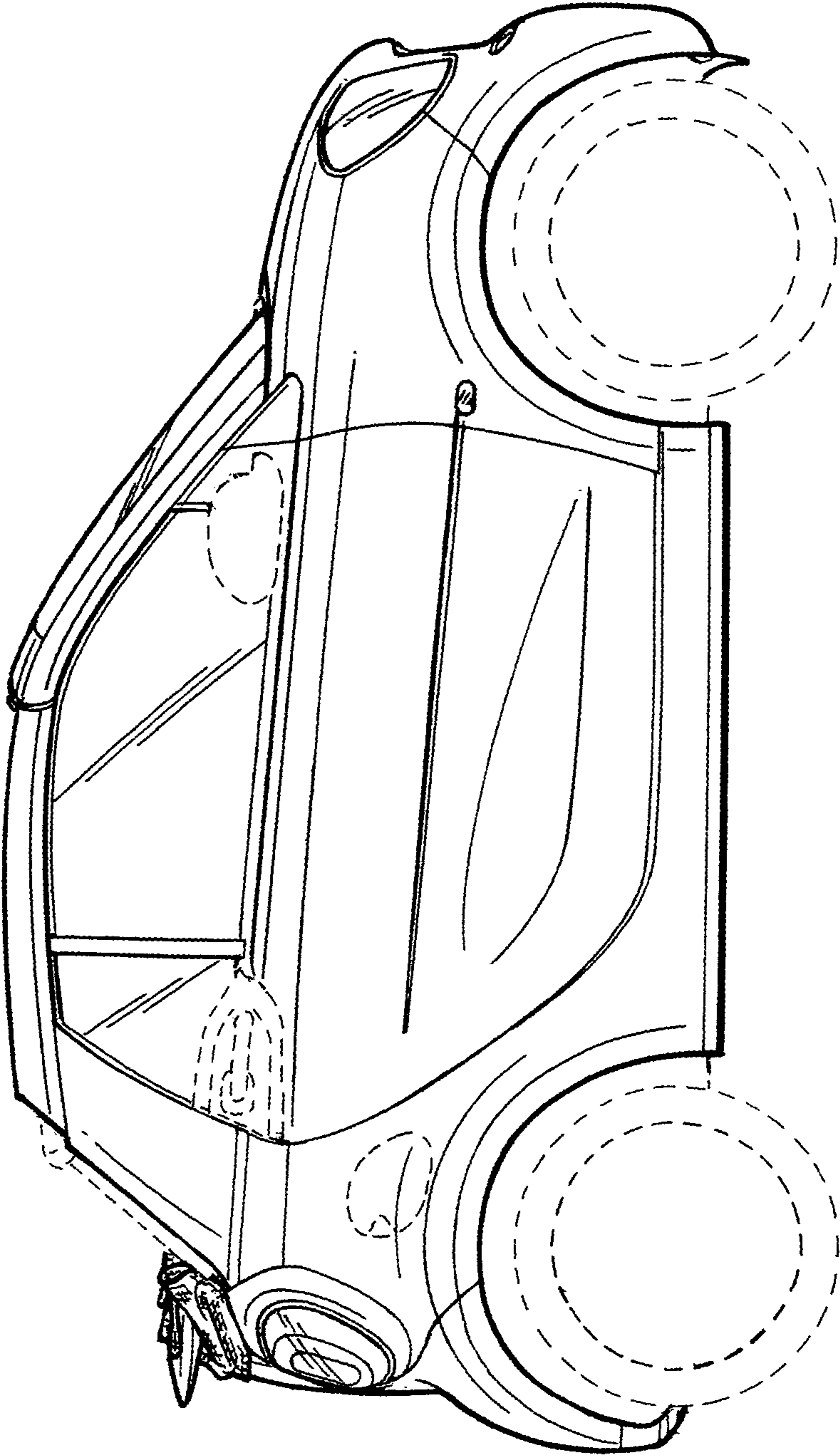

FIG. 4

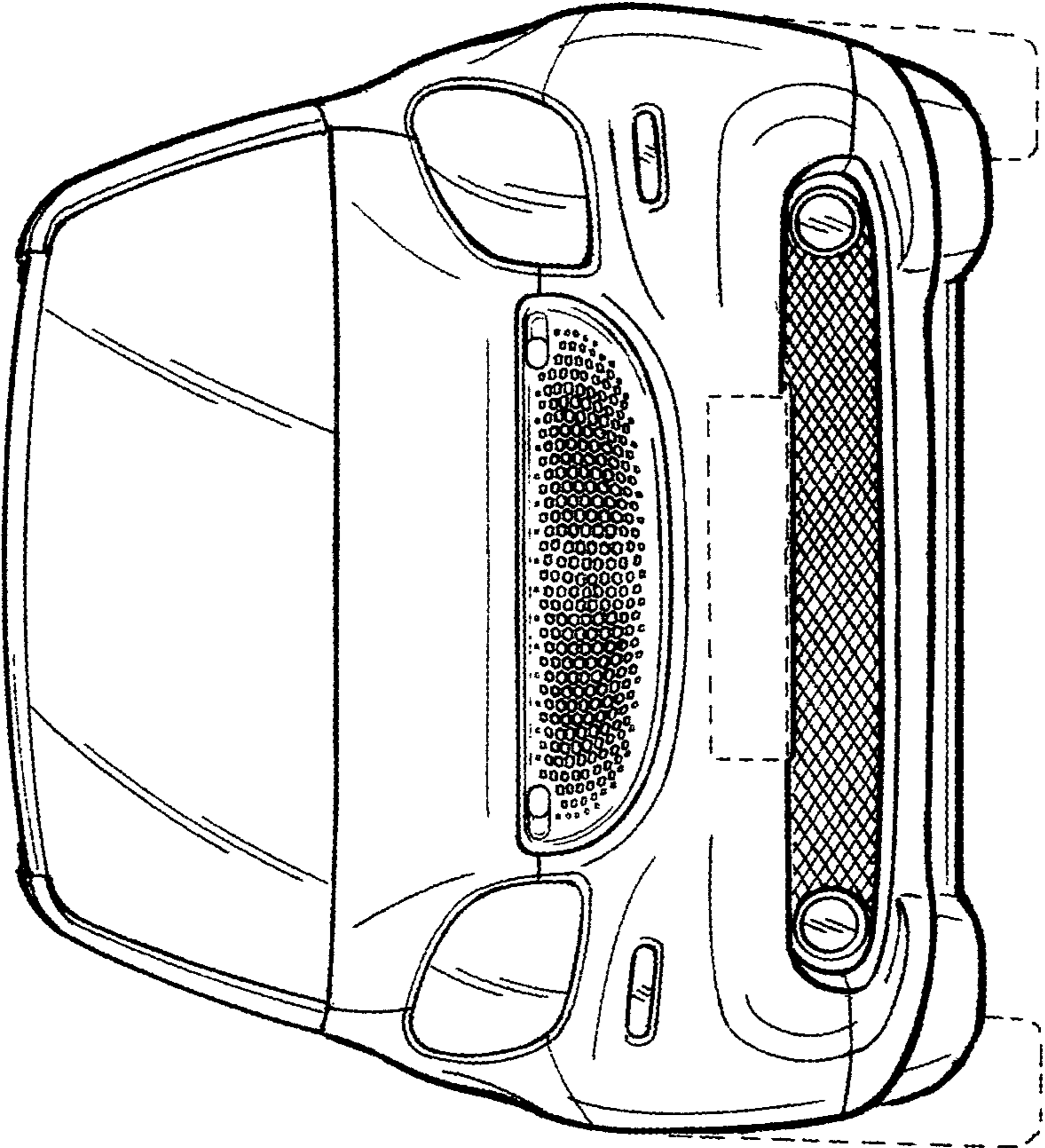

FIG. 5

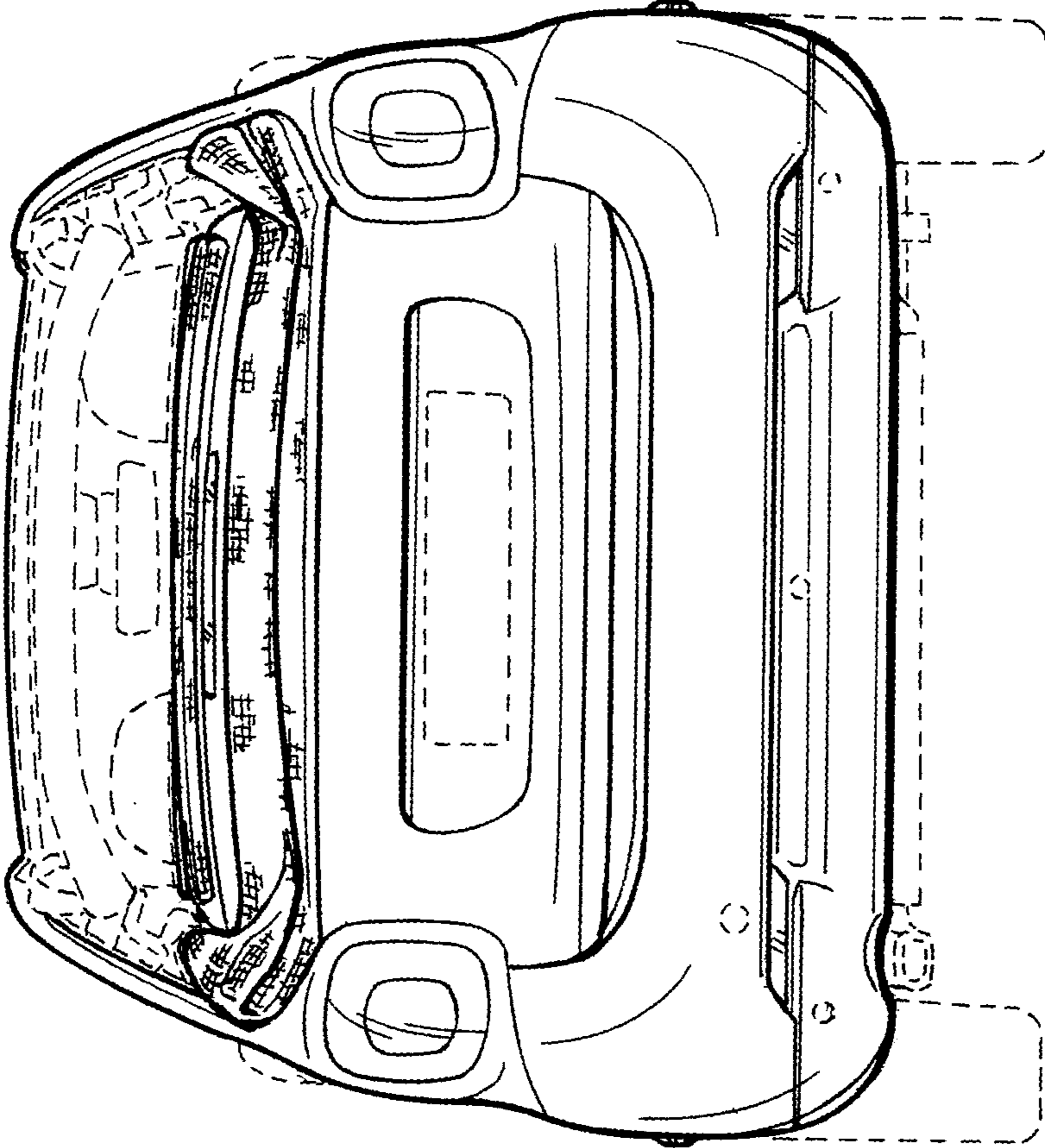

FIG. 6