



US00D768439S

(12) **United States Design Patent**
Shin et al.

(10) **Patent No.:** **US D768,439 S**

(45) **Date of Patent:** **** Oct. 11, 2016**

(54) **BOTTLE**

(71) Applicants: **Kia Motors Corporation**, Seoul (KR);
Ecojun Company, Seoul (KR)

(72) Inventors: **Yoon Jung Shin**, Gyeonggi-Do (KR);
Jun Seo Lee, Seoul (KR)

(73) Assignees: **Kia Motors Corporation**, Seoul (KR);
Ecojun Company, Seoul (KR)

(**) Term: **14 Years**

(21) Appl. No.: **29/515,946**

(22) Filed: **Jan. 28, 2015**

(30) **Foreign Application Priority Data**

Jul. 29, 2014 (KR) 30-2014-0037056

(51) **LOC (10) Cl.** **07-01**

(52) **U.S. Cl.**

USPC **D7/510**; D7/511; D9/526

(58) **Field of Classification Search**

USPC D7/507-512, 529-532, 533, 536, 213,
D7/392.1, 396.1, 396.2, 396.4, 900, 608;
D9/503, 504, 555, 568, 554, 567, 904,
D9/453, 442, 443, 773, 434, 435, 440, 444,
D9/447, 449, 526; D3/202; D24/197, 122;
220/592.16, 592.17, 592.27;
215/381-384

CPC B65D 23/00; B65D 47/066; B65D 41/04;
B65D 41/0414; B65D 47/08; A45F 3/16

See application file for complete search history.

(56) **References Cited**

U.S. PATENT DOCUMENTS

D199,210 S * 9/1964 Simeoni D9/440
4,676,387 A * 6/1987 Stephenson A61J 9/00
215/11.1
5,178,308 A * 1/1993 Endre B62J 11/00
215/306

D340,865 S * 11/1993 Endre D12/114
D369,943 S * 5/1996 Dark D7/392.1
D387,621 S * 12/1997 Sullivan D7/510
D394,113 S * 5/1998 Walsh D24/197
D412,033 S * 7/1999 Morano D24/197
D428,496 S * 7/2000 Thom D24/197
6,173,850 B1 * 1/2001 Scheetz, Jr. A61J 9/00
215/11.1
6,305,562 B1 * 10/2001 Chan A61J 9/00
215/11.1
D473,423 S * 4/2003 Rhoad D7/392.1
6,837,407 B1 * 1/2005 Towers B62J 9/005
220/840
D675,525 S * 2/2013 Hanai D9/447
D685,465 S * 7/2013 Reda D24/122
D704,986 S * 5/2014 Manies D7/392
D705,434 S * 5/2014 Spinetti D24/197
2009/0178997 A1 * 7/2009 Clark B65D 1/0223
215/384
2012/0085669 A1 * 4/2012 Diehl A47G 19/2227
206/459.1

* cited by examiner

Primary Examiner — Marianne Pandozzi

Assistant Examiner — Jae Liang

(74) *Attorney, Agent, or Firm* — Mintz Levin Cohn Ferris
Glovsky and Popeo, P.C.; Kongsik Kim

(57) **CLAIM**

The ornamental design for a bottle, as shown and described.

DESCRIPTION

FIG. 1 is a perspective view of a bottle showing our new design;

FIG. 2 is a front view thereof;

FIG. 3 is a rear view thereof;

FIG. 4 is a left side view thereof;

FIG. 5 is a right side view thereof;

FIG. 6 is a top view thereof;

FIG. 7 is a bottom view thereof; and,

FIG. 8 is a perspective view of the bottle in its open position.

The broken lines in the drawing depict portions of the bottle that form no part of the claimed design.

1 Claim, 8 Drawing Sheets

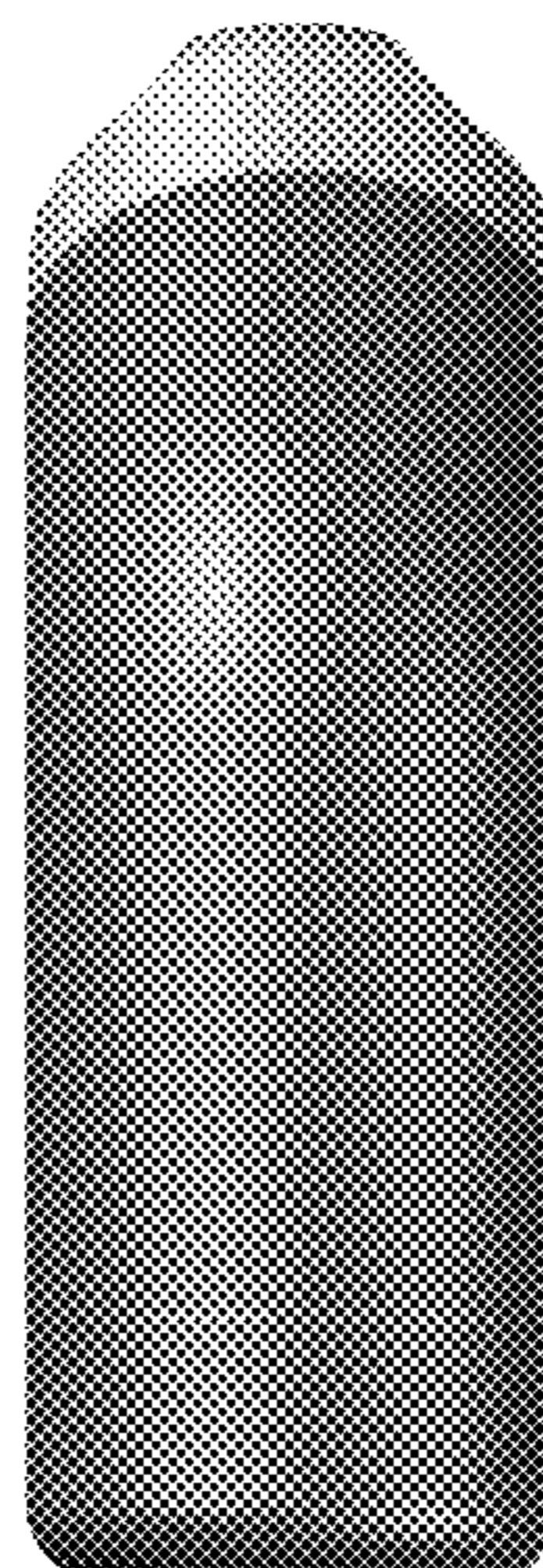
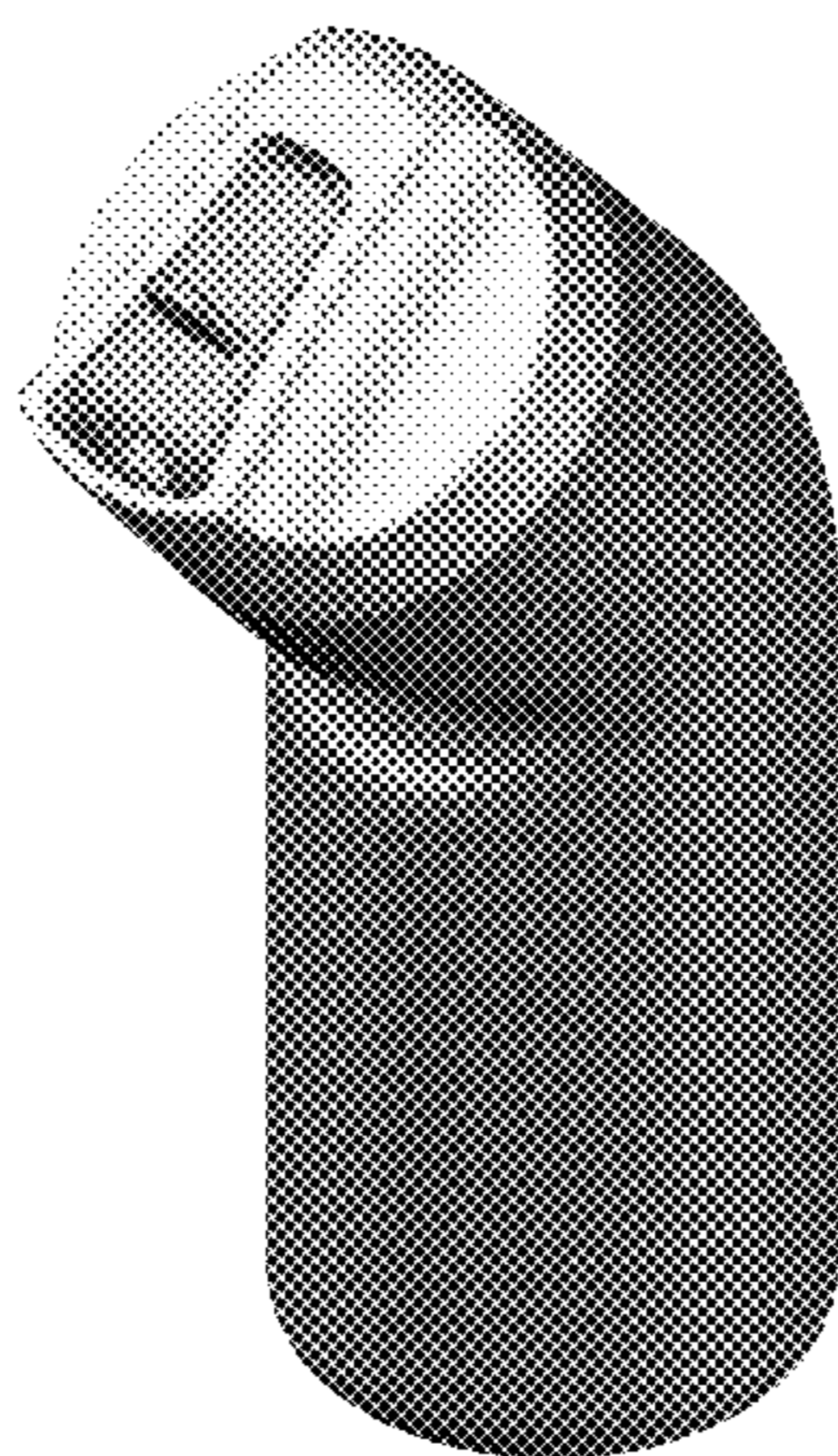

FIG. 1

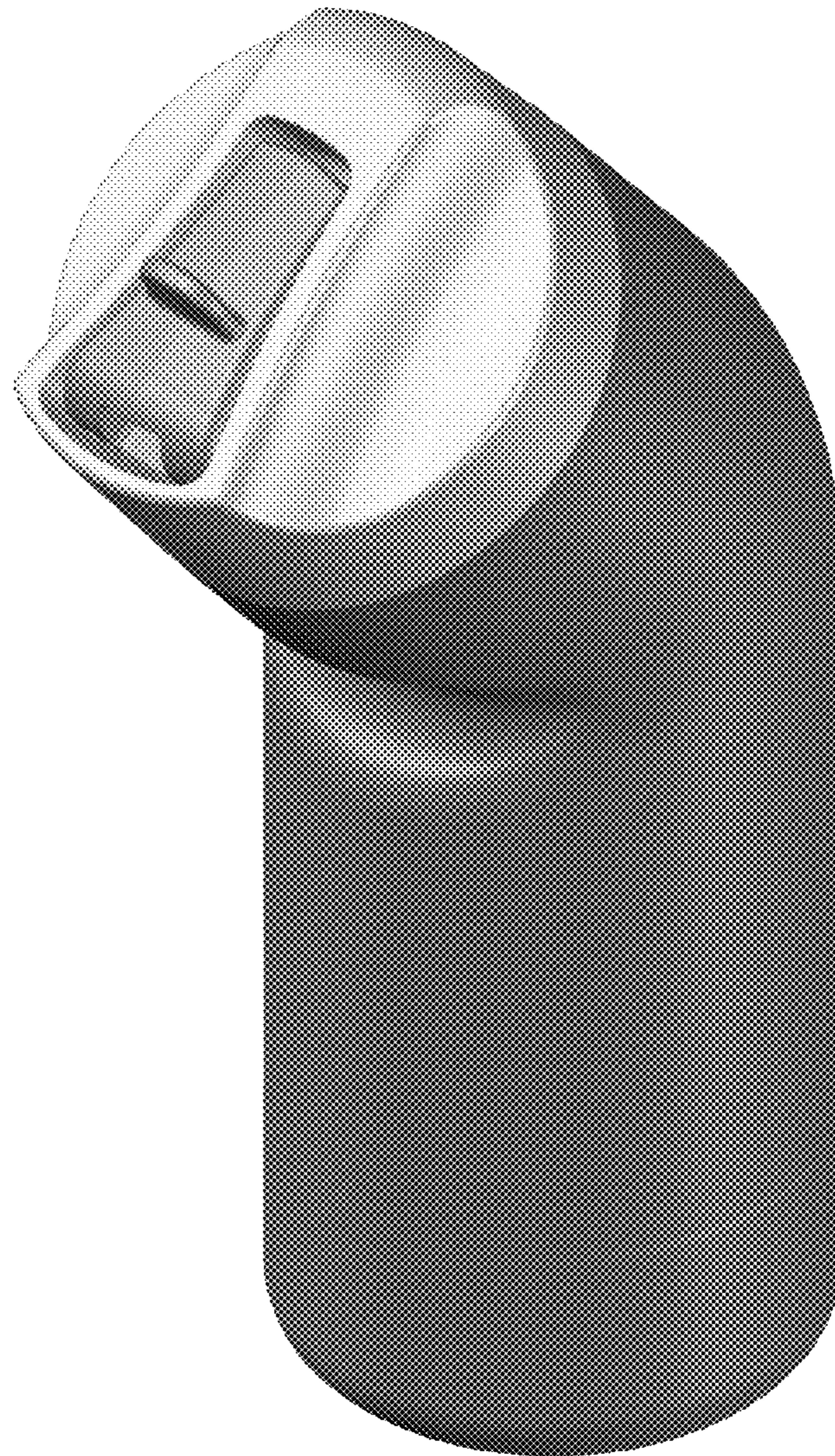

FIG. 2

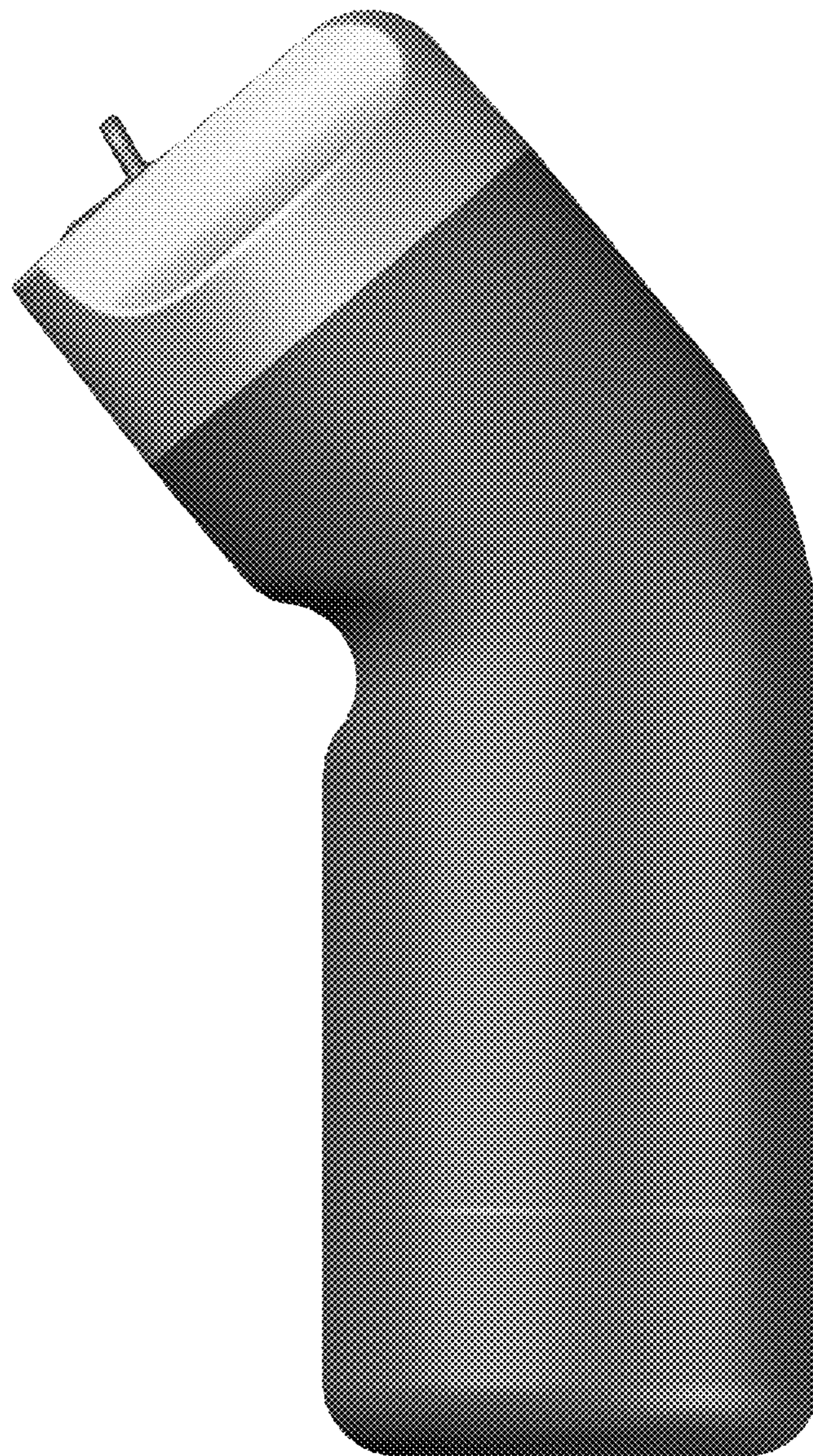

FIG. 3

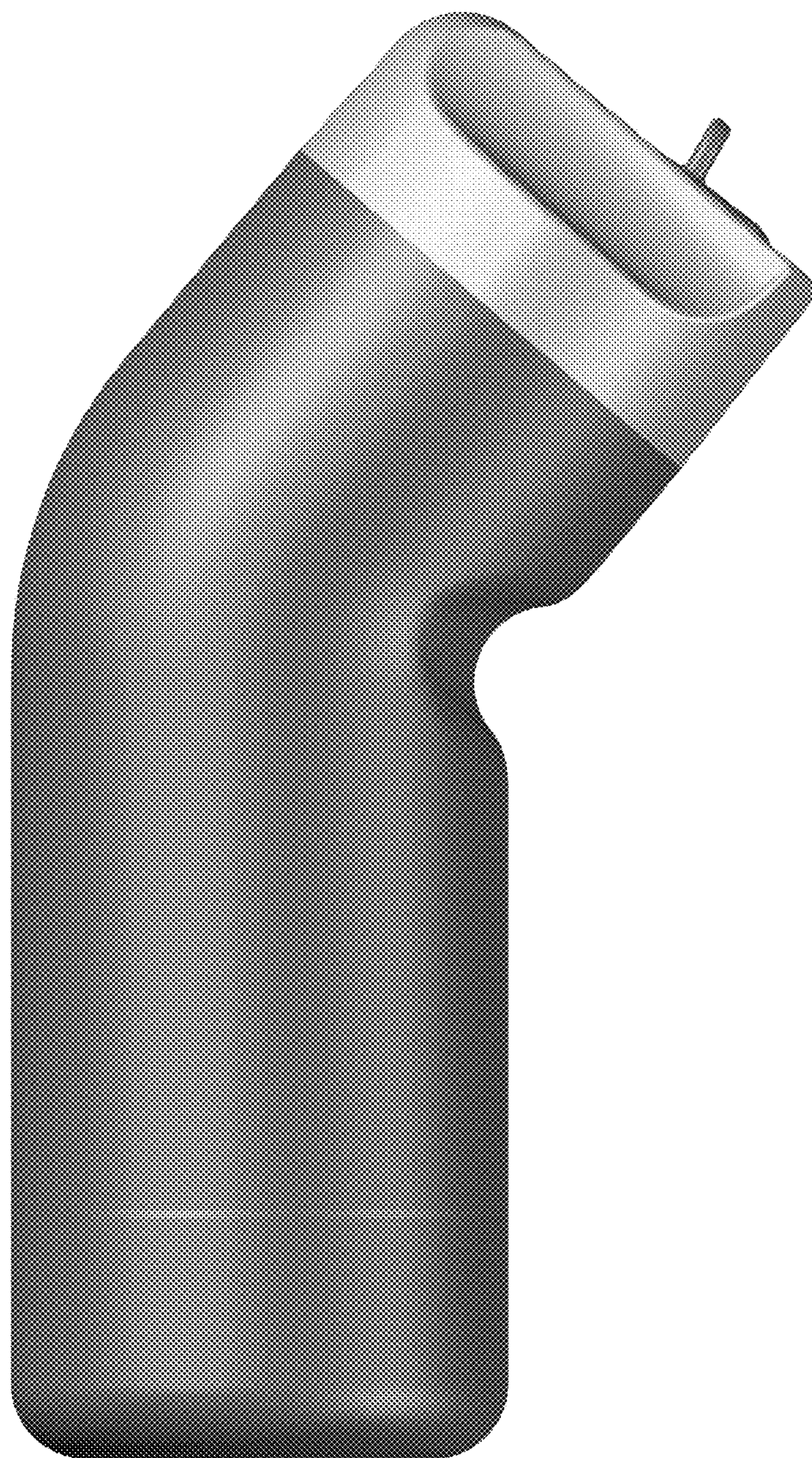

FIG. 4

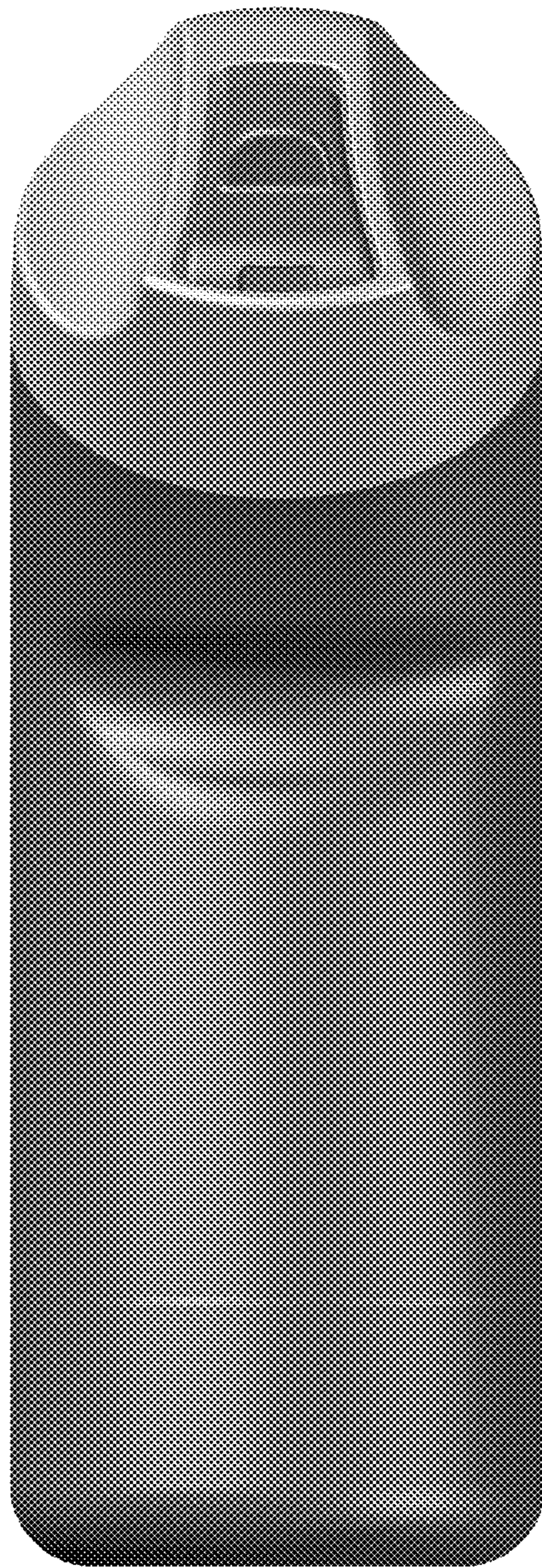

FIG. 5

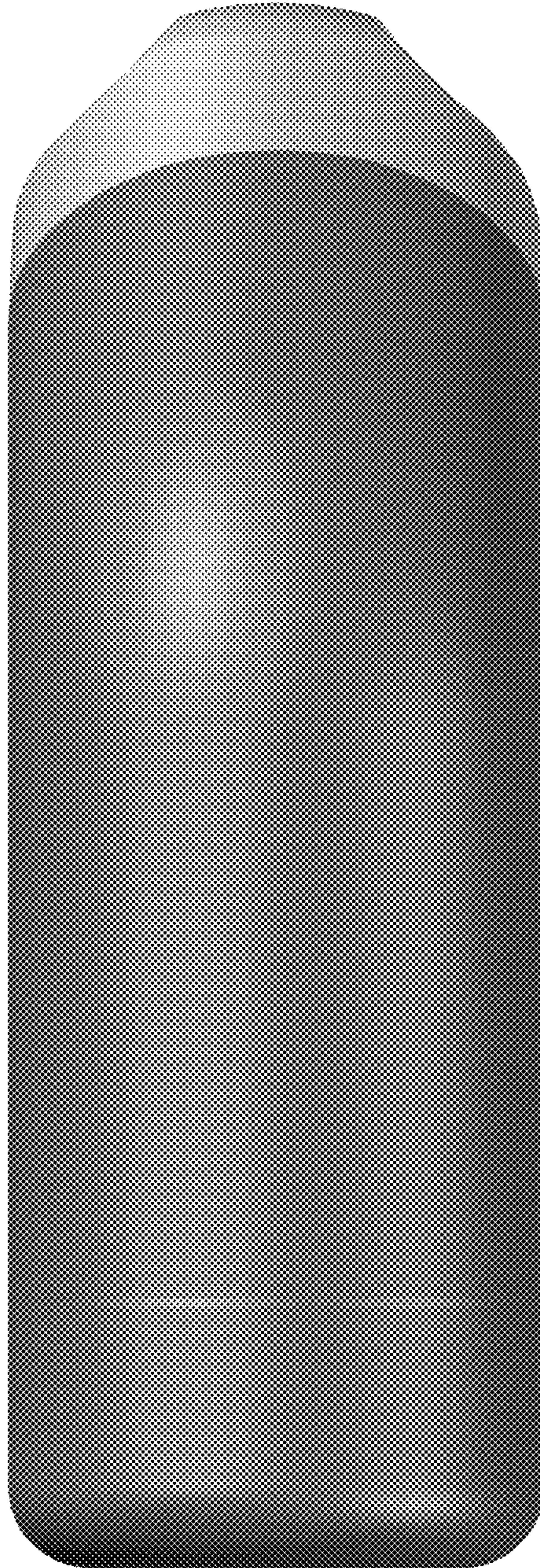

FIG. 6

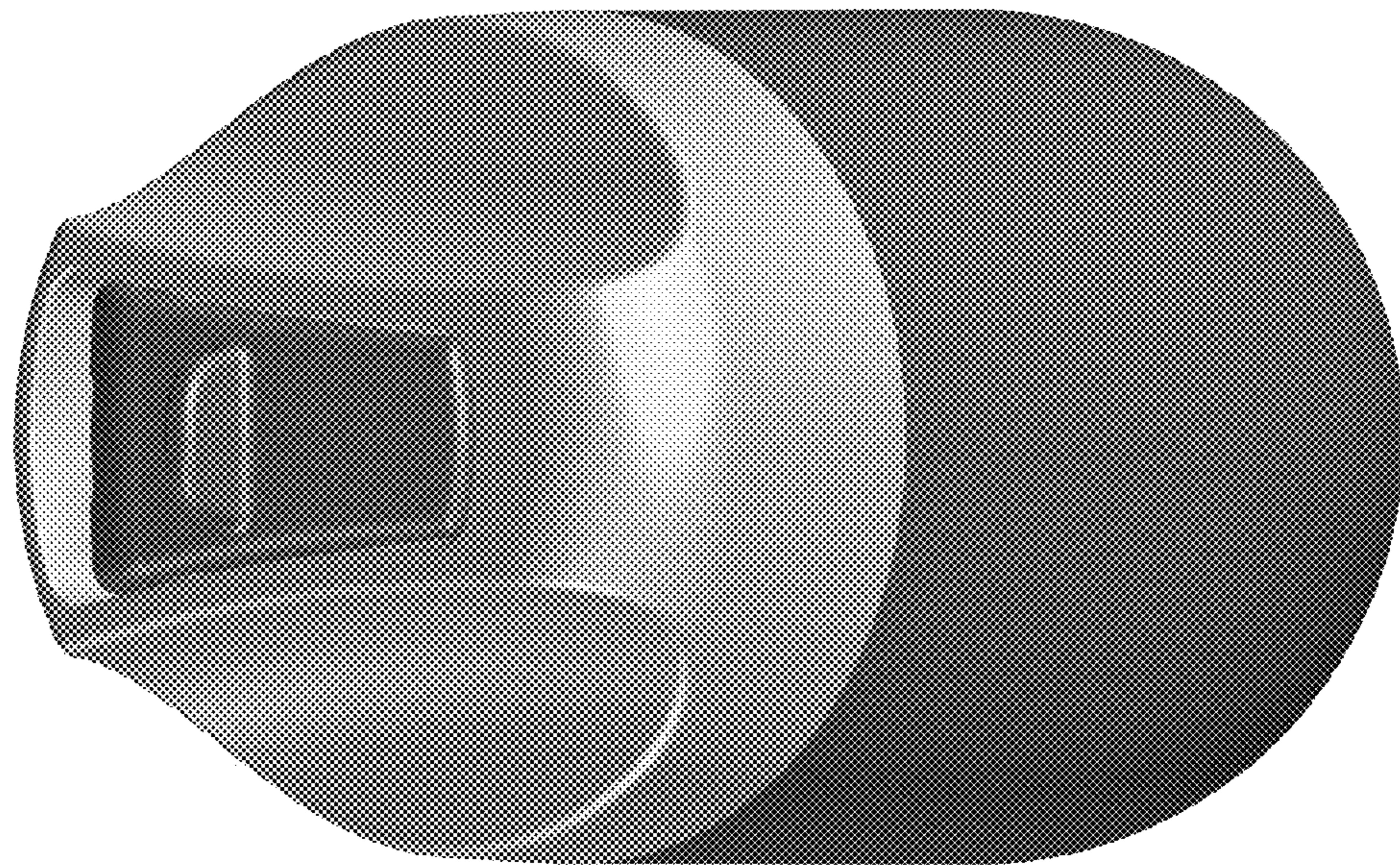

FIG. 7

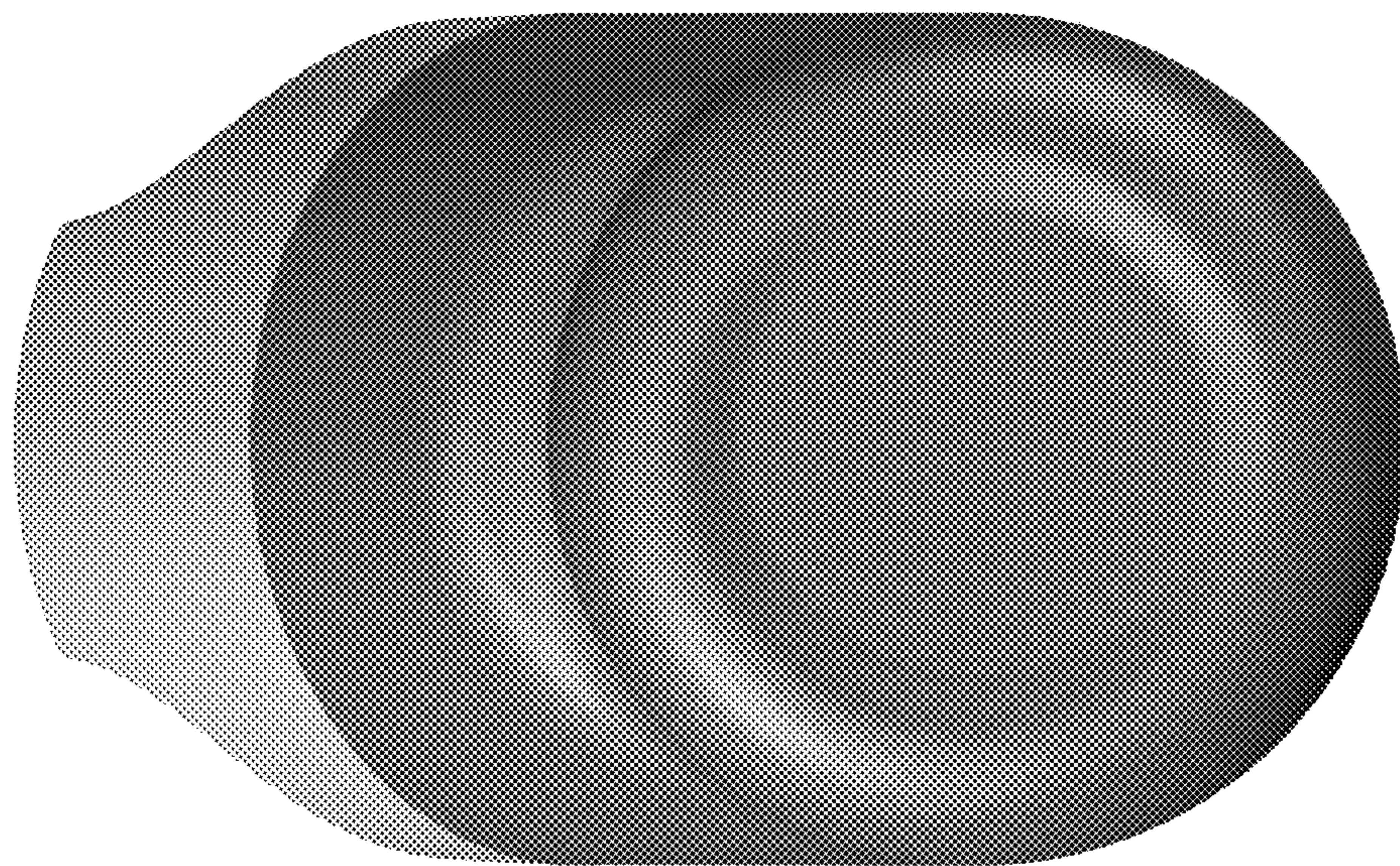

FIG. 8

