

US00D768430S

(12) **United States Design Patent**
Lee

(10) **Patent No.:** **US D768,430 S**
(45) **Date of Patent:** **** Oct. 11, 2016**

(54) **COOKING PAN FOR USE IN HEATING COOKERS**

(71) Applicant: **Jin Hee Lee**, Seoul (KR)

(72) Inventor: **Jin Hee Lee**, Seoul (KR)

(**) Term: **14 Years**

(21) Appl. No.: **29/526,233**

(22) Filed: **May 7, 2015**

(30) **Foreign Application Priority Data**

Jan. 5, 2015 (KR) 30-2015-0000254

(51) **LOC (10) Cl.** **07-02**

(52) **U.S. Cl.**
USPC **D7/362; D7/352; D7/409**

(58) **Field of Classification Search**
USPC D7/323, 352-362, 543, 545, 549, 550.1, D7/553.1-553.8, 554.1-554.4, 555, 584, D7/586, 688; D9/430-433, 455-456, 737, D9/756-762; D19/92
CPC A21B 3/00; A21B 3/003; A21B 3/13; A21B 3/15; A21B 3/134; A21B 5/00; A21B 5/02; A47J 27/004; A47J 36/022; A47J 36/025; A47J 36/027; A47J 36/38; A47J 36/2483; A47J 37/00; A47J 37/04; A47J 37/067; A47J 37/0676; A47J 37/108; A47J 37/10; A47J 43/28; A47J 43/284; A47G 23/06; B65D 1/22; B65D 1/24; B65D 1/34; B65D 1/36; B65D 81/343; B65D 85/36
See application file for complete search history.

(56) **References Cited**

U.S. PATENT DOCUMENTS

- 3,664,256 A * 5/1972 Peirce A47J 37/0676 99/425
- D223,854 S * 6/1972 Swett D7/392.1
- D229,656 S * 12/1973 Garcia D7/359
- D246,411 S * 11/1977 Blanchard 30/303
- D252,008 S * 6/1979 Jeambey 426/243

- D264,036 S * 4/1982 Pomroy D7/359
- D335,795 S * 5/1993 Conti D7/359
- 6,082,249 A * 7/2000 Su A47J 27/004 99/340
- D439,792 S * 4/2001 Hedrington D7/323
- D440,490 S * 4/2001 Lizzio D9/428
- 6,363,842 B1 * 4/2002 Lin A47J 36/38 126/299 D
- D458,078 S * 6/2002 Lin D7/362
- 6,782,801 B1 * 8/2004 Correa A47J 37/067 99/340
- D621,650 S * 8/2010 DeLeo D7/354
- D653,904 S * 2/2012 Lee D7/362
- D678,712 S * 3/2013 Mehler D7/354
- D684,808 S * 6/2013 Mehler D7/354
- D688,086 S * 8/2013 Lee D7/362
- D688,087 S * 8/2013 Lee D7/362
- D688,088 S * 8/2013 Lee D7/362

(Continued)

Primary Examiner — Ricky Pham

(74) *Attorney, Agent, or Firm* — Kile Park Reed & Houtteman PLLC

(57) **CLAIM**

I claim, the ornamental design for a cooking pan for use in heating cookers, as shown and described.

DESCRIPTION

FIG. 1 is a top and front perspective view of a cooking pan for use in heating cookers, showing my new design;
 FIG. 2 is a front view thereof;
 FIG. 3 is a rear view thereof;
 FIG. 4 is a left side view thereof;
 FIG. 5 is a right side view thereof;
 FIG. 6 is a top plan view thereof;
 FIG. 7 is a bottom plan view thereof; and,
 FIG. 8 is a reference perspective view showing how upper and lower cooking pans of the cooking pan for use in heating cookers are assembled with and disassembled from each other in the arrow direction.

The broken lines shown in the figures are for illustrative purposes only and form no part of the claimed design.

1 Claim, 8 Drawing Sheets

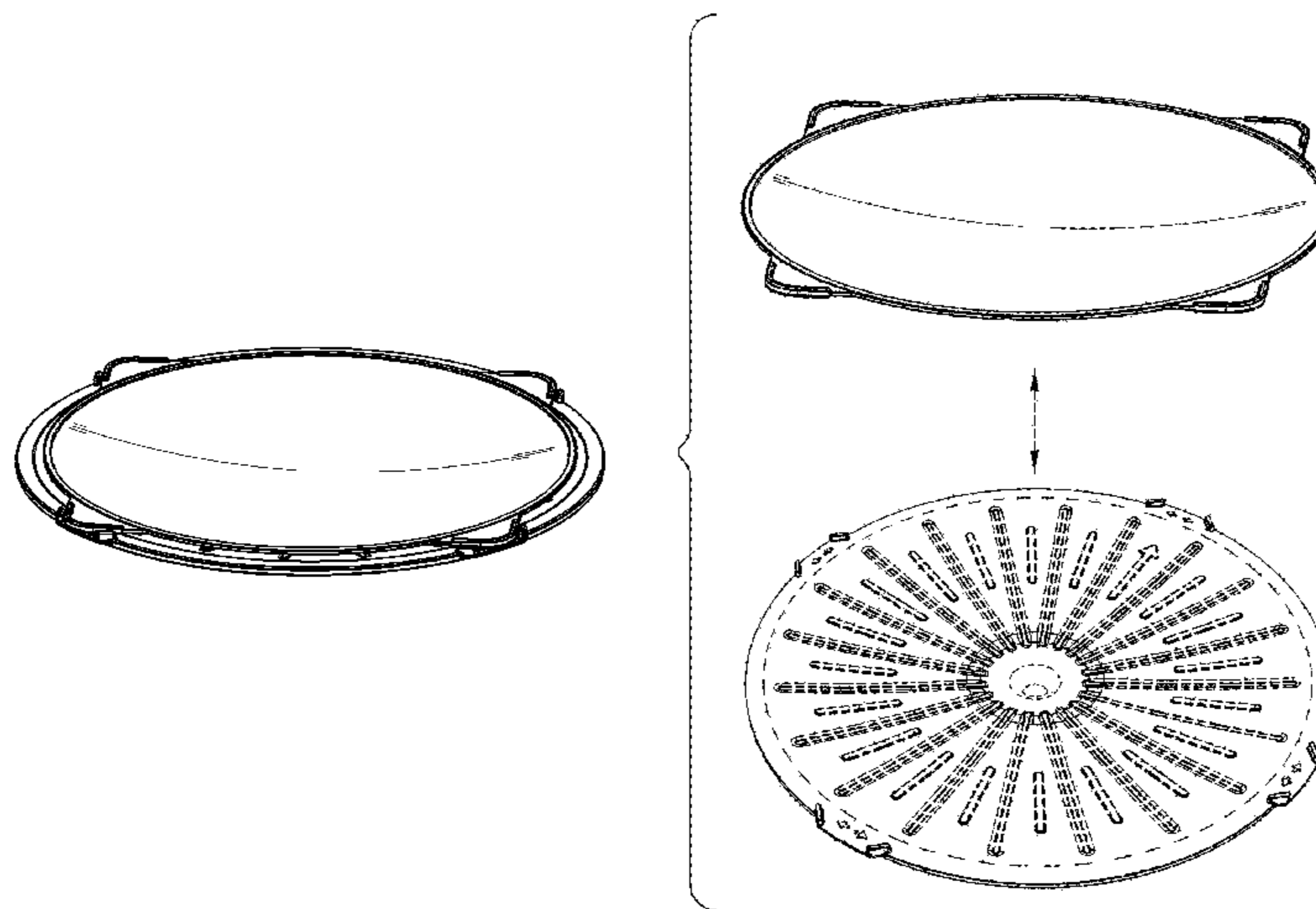

US D768,430 S

Page 2

(56)

References Cited

U.S. PATENT DOCUMENTS

D688,089 S *	8/2013	Lee	D7/362	
D688,090 S *	8/2013	Lee	D7/362	
D695,059 S *	12/2013	Mehler	D7/354	* cited by examiner
D707,078 S *	6/2014	Rivera	D7/354	
D749,906 S *	2/2016	Lee	D7/362	
2009/0095168 A1 *	4/2009	Shu	A47J 37/108 99/425	

FIG. 1

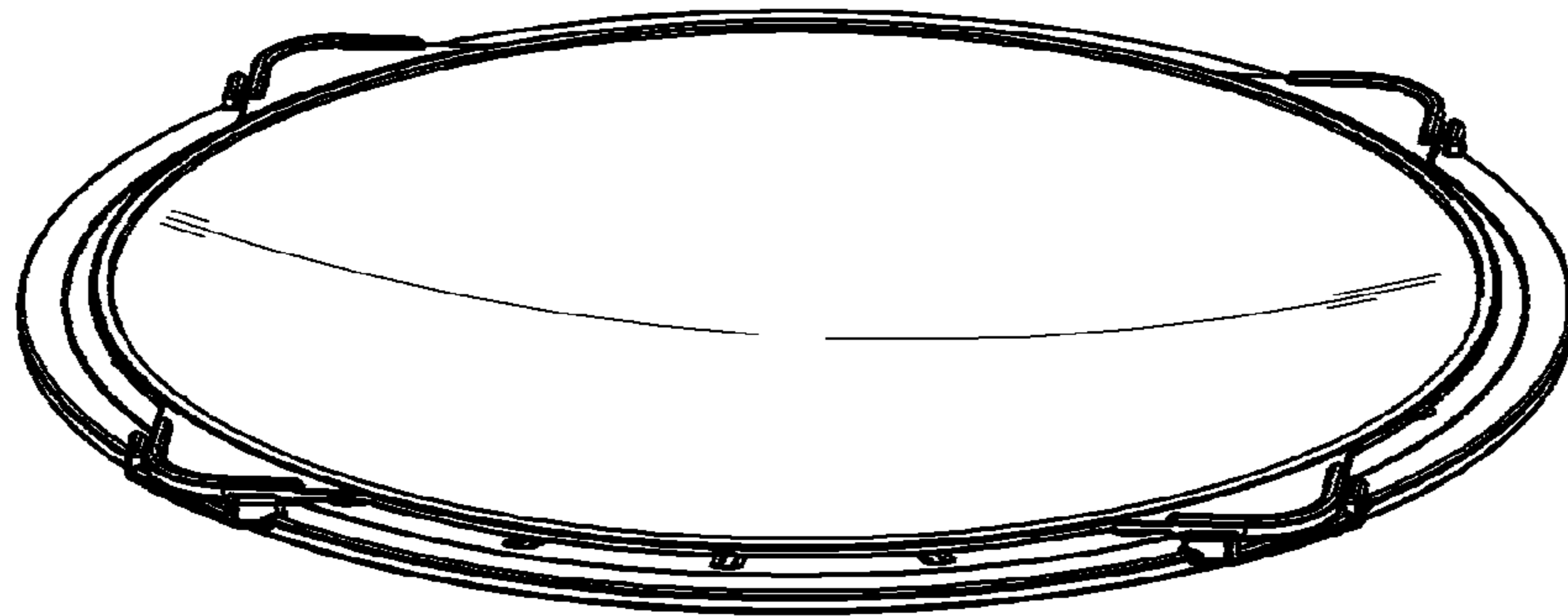

FIG. 2

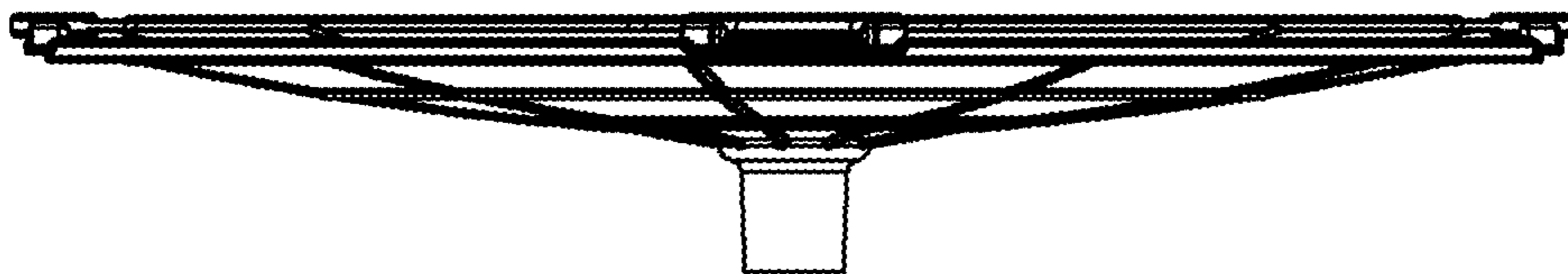

FIG. 3

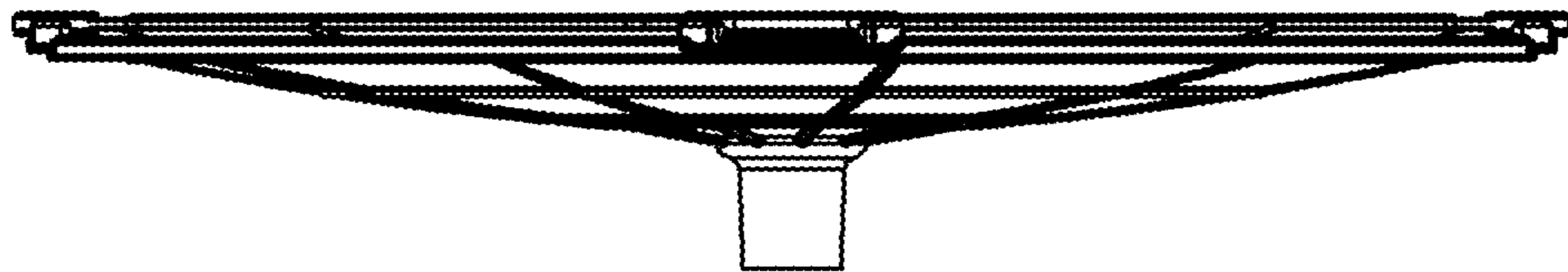

FIG. 4

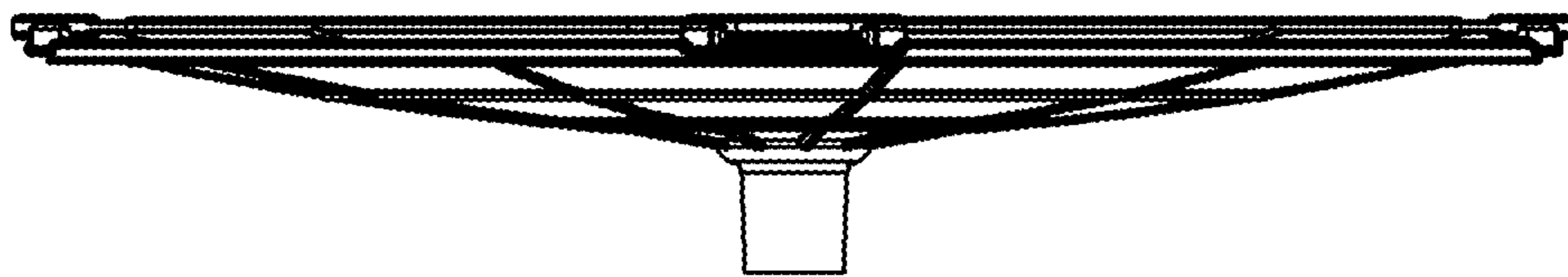

FIG. 5

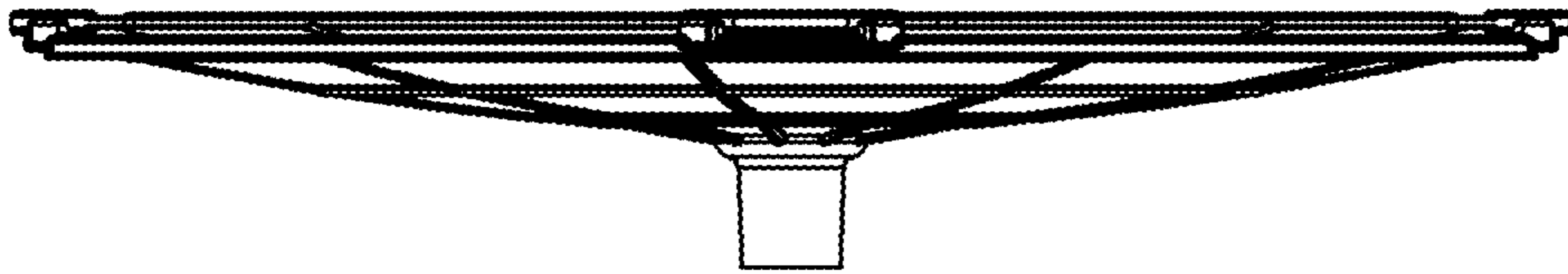

FIG. 6

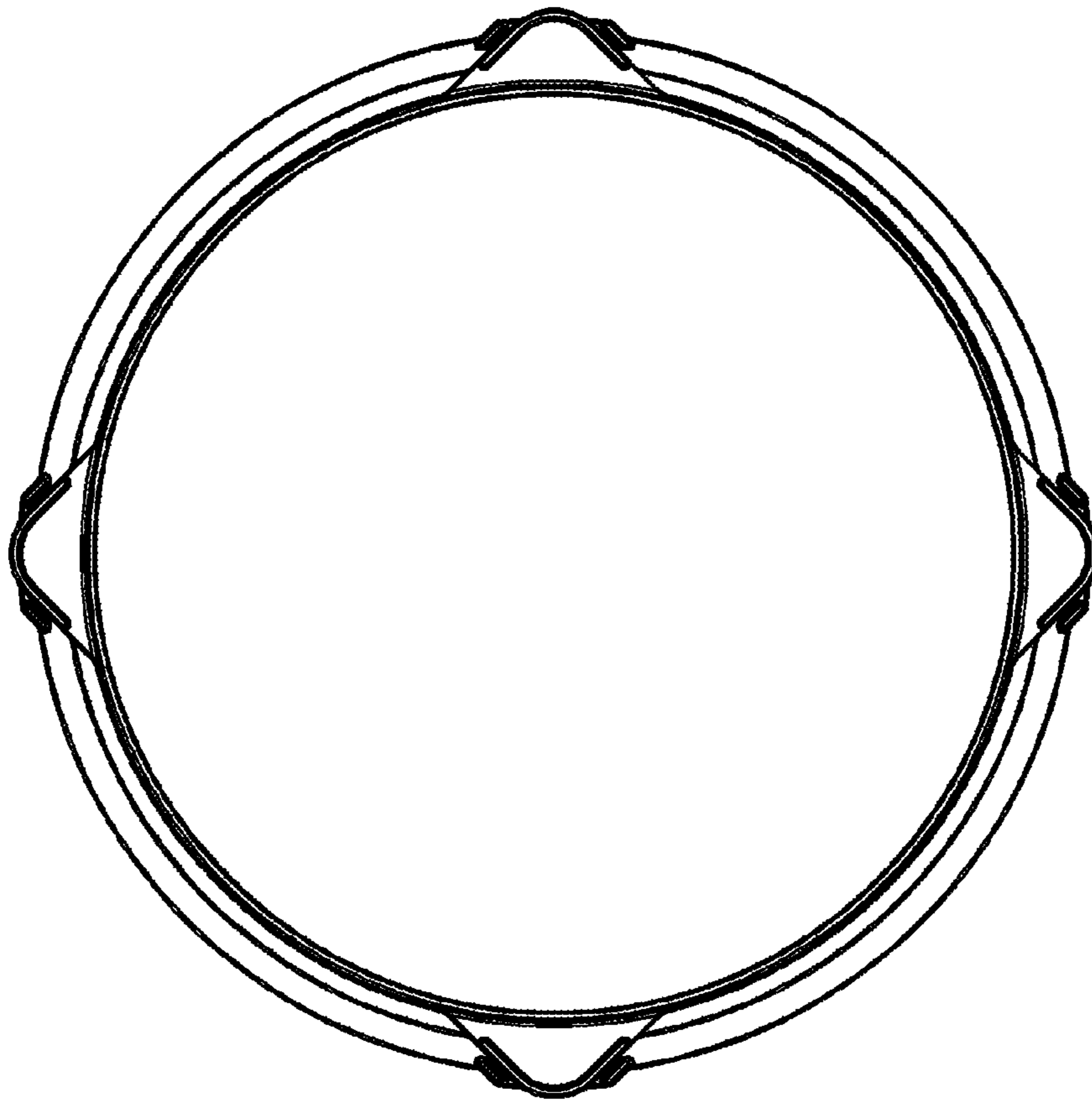

FIG. 7

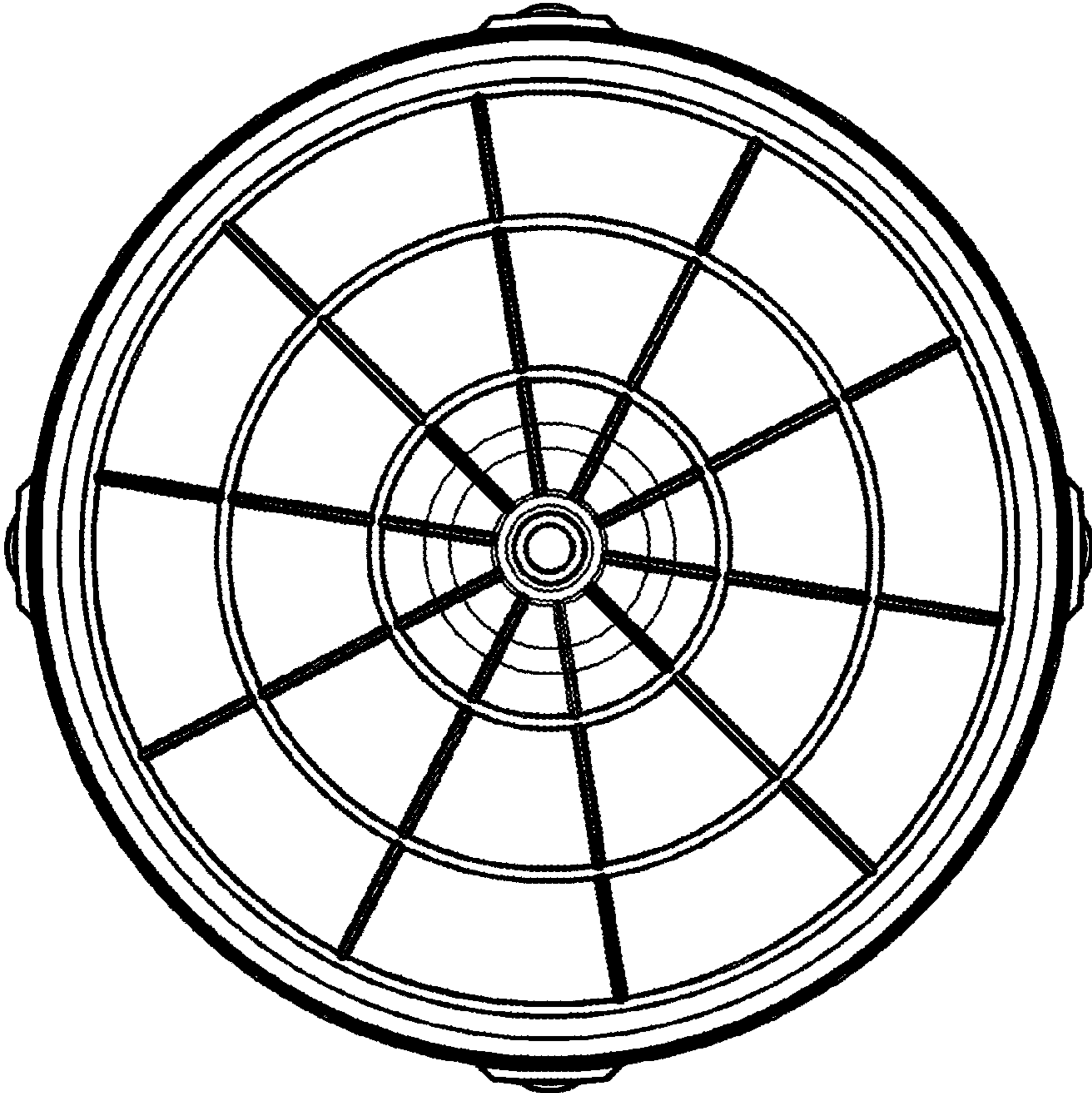

FIG. 8

