

US00D768382S

(12) **United States Design Patent** (10) **Patent No.:** **US D768,382 S**  
**Wu** (45) **Date of Patent:** **\*\* Oct. 11, 2016**

(54) **WALLET**  
(71) Applicant: **Arthur Wu**, North Hollywood, CA (US)  
(72) Inventor: **Arthur Wu**, North Hollywood, CA (US)  
(73) Assignee: **Arthur Wu**, North Hollywood, CA (US)  
(\*\*) Term: **15 Years**  
(21) Appl. No.: **29/545,205**  
(22) Filed: **Nov. 10, 2015**  
(51) **LOC (10) Cl.** ..... **03-01**  
(52) **U.S. Cl.**  
USPC ..... **D3/247**  
(58) **Field of Classification Search**  
USPC ..... D2/861; D3/20, 203.6, 205, 206, 208, D3/226, 232, 245, 247-253, 303, 324; D11/78.1; D14/250; D19/3, 27, 75, 86, D19/91, 102  
CPC ..... A45C 1/06; A45C 3/08; B68F 1/00  
See application file for complete search history.

D694,007 S \* 11/2013 D'Amore ..... D3/247  
D706,536 S \* 6/2014 Nikosey ..... D3/247  
D713,143 S \* 9/2014 Ashley ..... D3/247  
D716,043 S \* 10/2014 Wilk ..... D3/247  
D718,525 S \* 12/2014 Kim ..... D3/247  
D723,798 S \* 3/2015 Sha ..... D3/247  
D724,840 S \* 3/2015 Fridstrom ..... D3/247  
D724,841 S \* 3/2015 Schneider ..... D3/247  
2005/0279435 A1\* 12/2005 Coates ..... A45C 11/182  
150/147

**OTHER PUBLICATIONS**

Elephant Wallet—downloaded on Mar. 6, 2016 from www.elephantwallet.com.  
Humm Wallet—downloaded on Mar. 6, 2016 from www.hummwallet.com.  
Ridge Wallet—downloaded on Mar. 6, 2016 from www.ridgewallet.com/.  
Asset Wallet—downloaded on Mar. 6, 2016 from www.kickstarter.com/projects/princesation/asset-the-modern-wallet-with-nfc-technology.  
Cardstack Wallet—downloaded on Mar. 6, 2016 from http://cardstack.co.

(Continued)

*Primary Examiner* — Susan E Krakower  
*Assistant Examiner* — Lisa A Grabenstetter

(56) **References Cited**

**U.S. PATENT DOCUMENTS**

D527,898 S \* 9/2006 Tavone ..... D3/247  
D553,354 S \* 10/2007 Kohler ..... D3/247  
D574,614 S \* 8/2008 Sanders ..... D3/247  
D584,049 S \* 1/2009 Uzelac ..... D3/247  
D590,151 S \* 4/2009 Karobkina ..... D3/247  
D611,249 S \* 3/2010 Uzelac ..... D3/247  
D616,295 S \* 5/2010 Britt ..... D19/9  
D620,252 S \* 7/2010 Keels ..... D3/247  
D622,958 S \* 9/2010 Moore ..... D3/247  
D628,796 S \* 12/2010 Uzelac ..... D3/247  
D632,076 S \* 2/2011 Westrick ..... D3/247  
D638,624 S \* 5/2011 Lyons ..... D3/247  
D650,581 S \* 12/2011 Wallace ..... D3/247  
D687,630 S \* 8/2013 Warner ..... D3/247  
D690,931 S \* 10/2013 Minn ..... D3/247

(57) **CLAIM**  
The ornamental design for a wallet, as shown and described.

**DESCRIPTION**

FIG. 1 is a perspective view of a wallet, showing my new design;  
FIG. 2 is a bottom plan view thereof;  
FIG. 3 is a top plan view thereof;  
FIG. 4 is a right side view thereof;  
FIG. 5 is a left side view thereof;  
FIG. 6 is a front view thereof; and,  
FIG. 7 is a back view thereof.  
The broken lines are included to show unclaimed portions of the design.

**1 Claim, 6 Drawing Sheets**

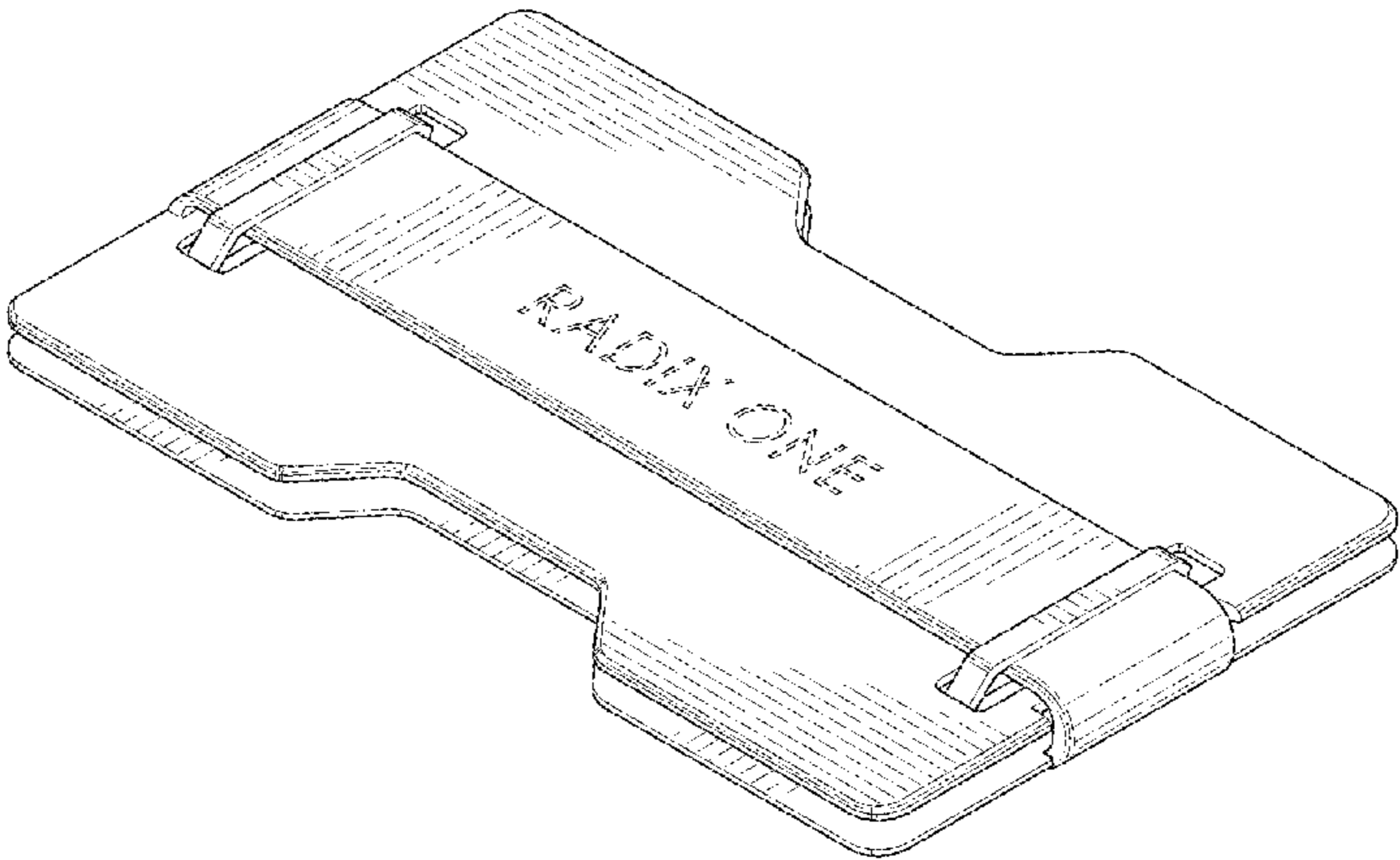

(56)

**References Cited**

Silverback Wallet—downloaded from Mar. 6, 2016 from [www.amazon.com/dp/B00PN2B9TG/?tag=slimwallet-20](http://www.amazon.com/dp/B00PN2B9TG/?tag=slimwallet-20).

Minimo Wallet—downloaded from Mar. 6, 2016 from [www.minimostore.com](http://www.minimostore.com).

OTHER PUBLICATIONS

Obstructures Wallet—downloaded from Mar. 6, 2016 from <http://obstructures.org/work/thing/18/wallet-aluminum-plate>.

\* cited by examiner

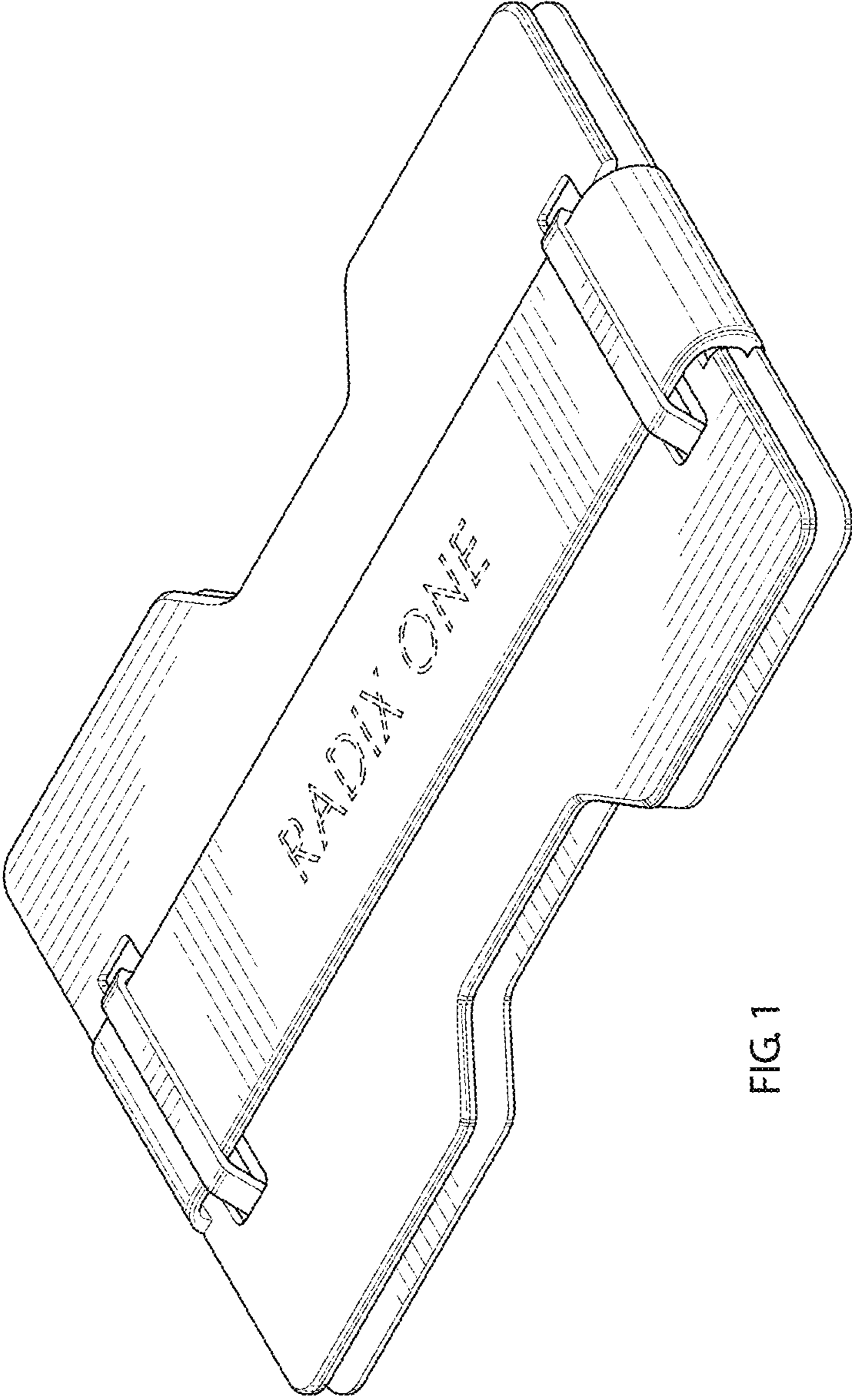

FIG. 1

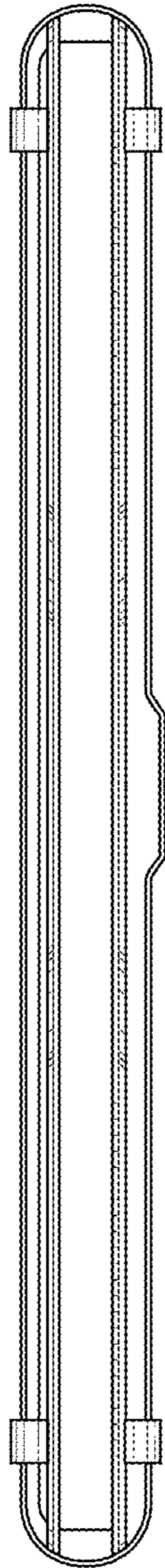

FIG. 2

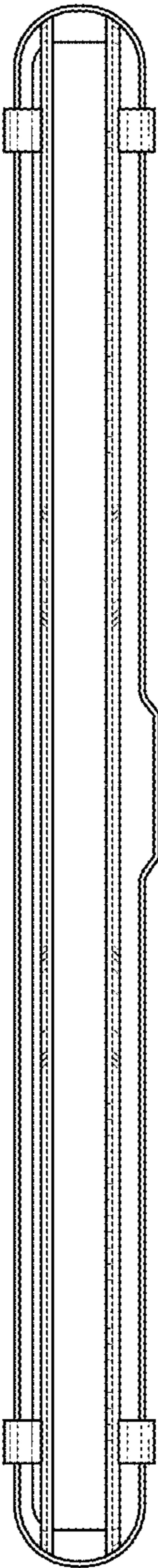

FIG. 3

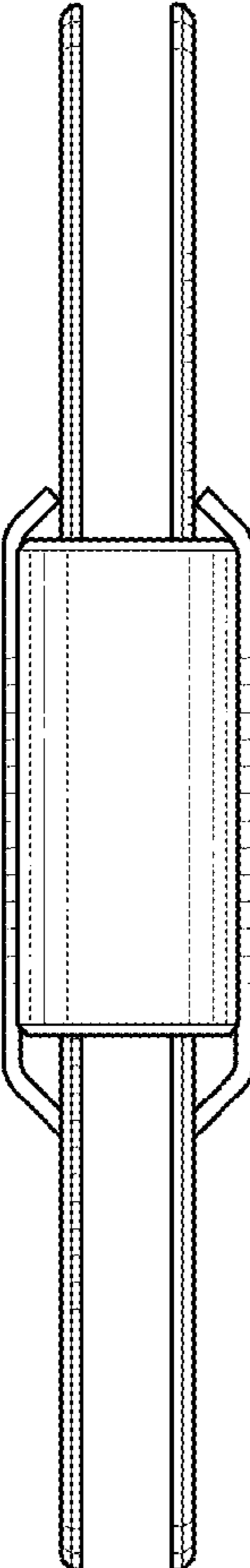

FIG. 4

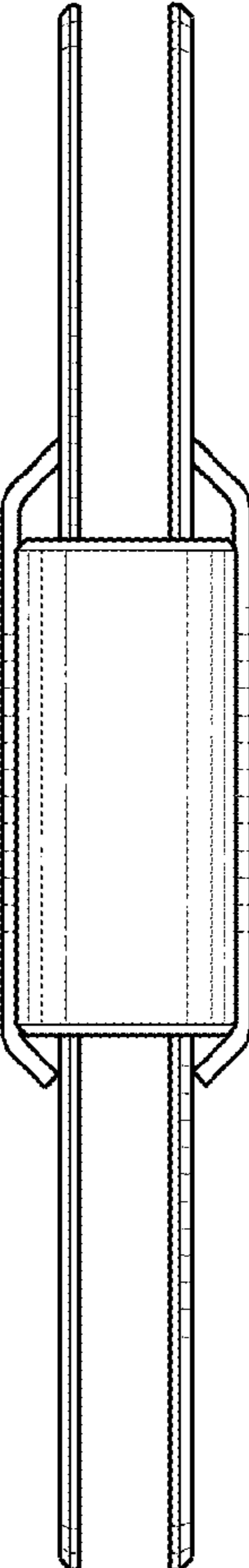

FIG. 5

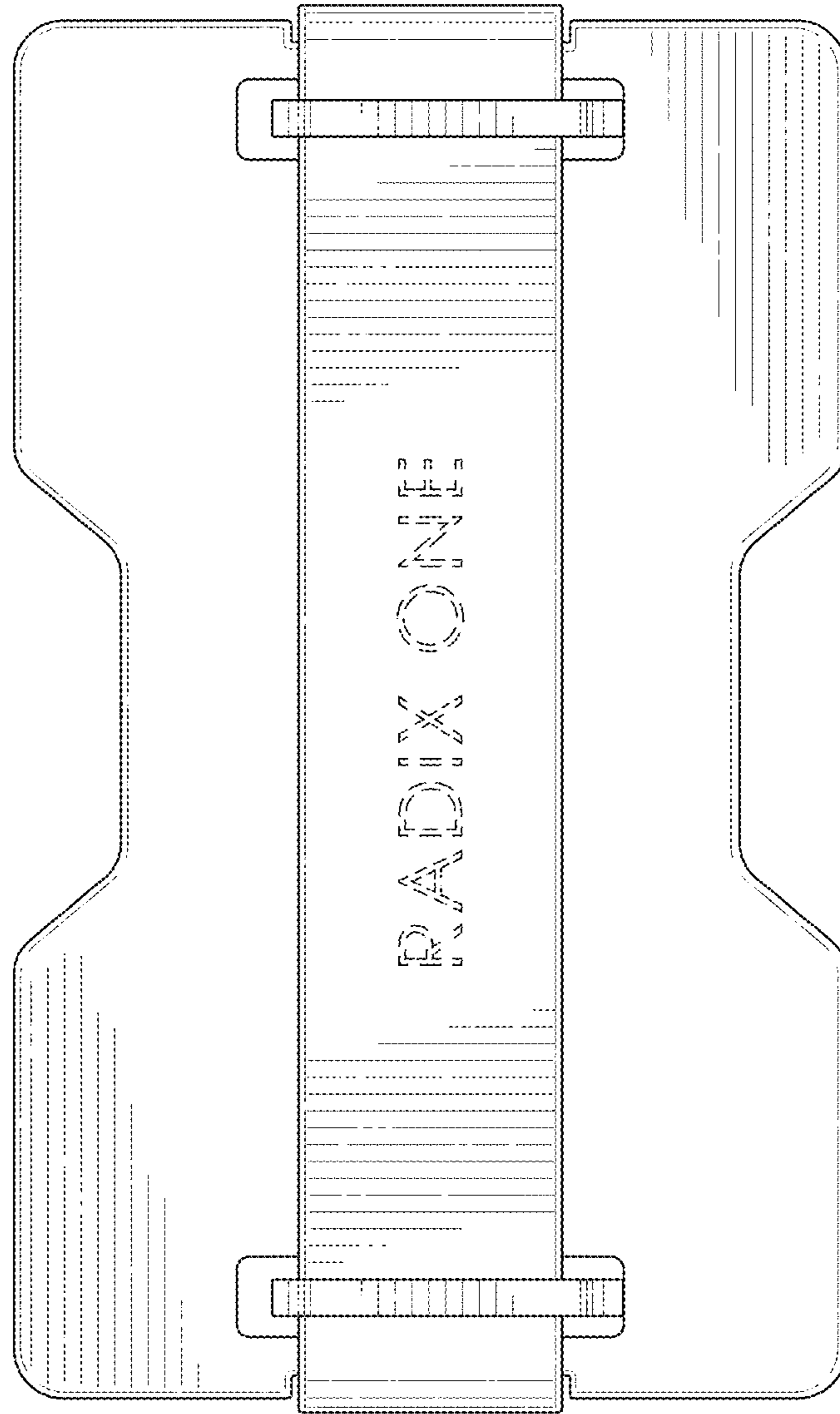

FIG. 6

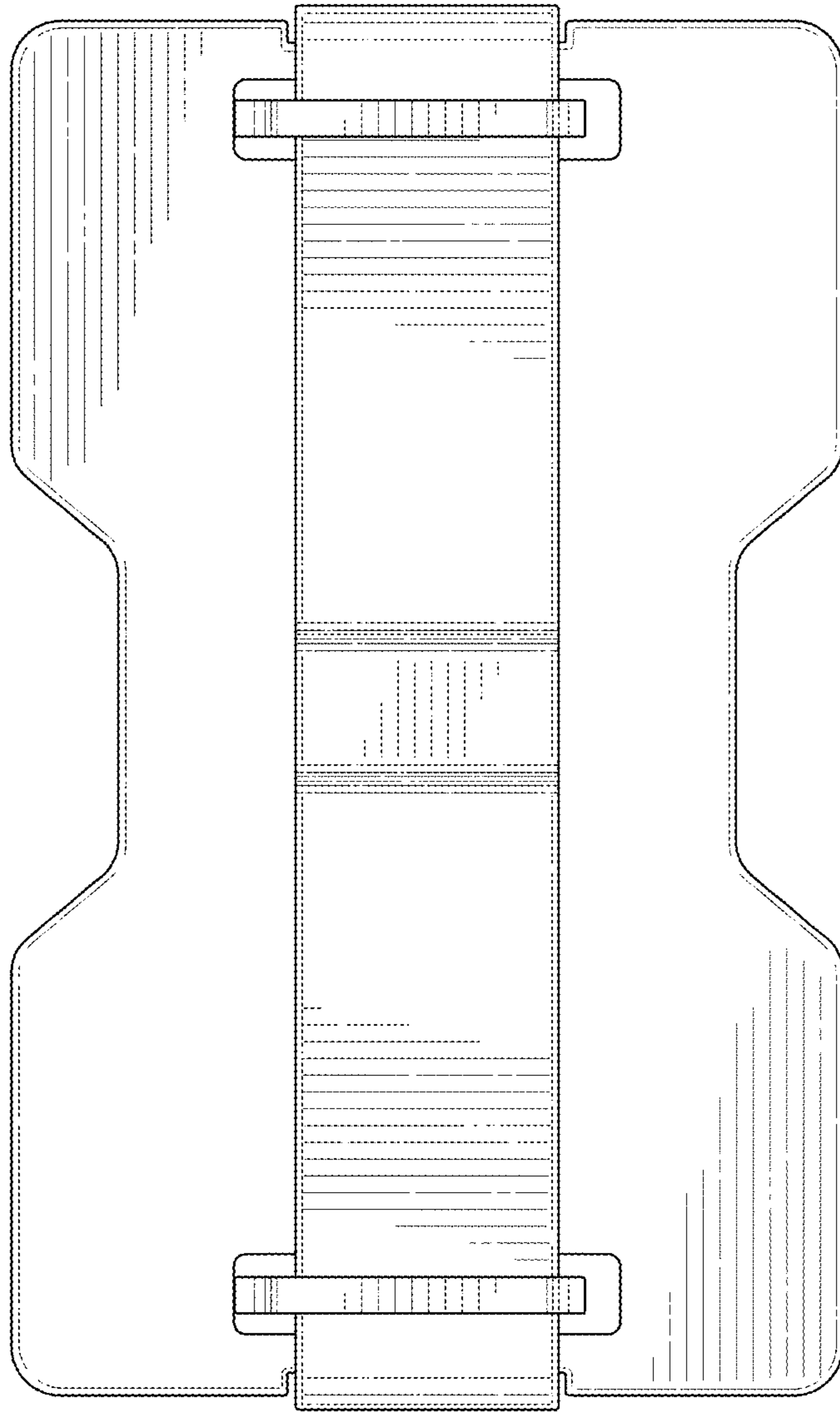

FIG. 7