



US00D768313S

(12) **United States Design Patent**
Kagawa

(10) **Patent No.:** **US D768,313 S**

(45) **Date of Patent:** **** Oct. 4, 2016**

(54) **AUTOCLAVE**

(71) Applicant: **Takeshi Kagawa**, Kanuma (JP)

(72) Inventor: **Takeshi Kagawa**, Kanuma (JP)

(73) Assignee: **Nakanishi Inc.**, Kanuma-shi (JP)

(**) Term: **14 Years**

(21) Appl. No.: **29/519,241**

(22) Filed: **Mar. 3, 2015**

(51) **LOC (10) Cl.** **24-01**

(52) **U.S. Cl.**
USPC **D24/217**

(58) **Field of Classification Search**
USPC D24/216, 217, 218, 227-232; D32/1,
D32/25
CPC A61L 2/26; A61L 24/17; A61L 2/18;
A61L 2/025; A61L 2202/122; A61L 2202/10;
A61L 2202/11; A61L 2202/14; A61L
2202/23; A61L 2202/24; A61L 2202/182
See application file for complete search history.

(56) **References Cited**

U.S. PATENT DOCUMENTS

D404,827 S * 1/1999 Thoburn D24/217
6,797,233 B1 * 9/2004 De Heus A61L 2/07
422/113

D546,473 S * 7/2007 Xu D24/217
D551,773 S * 9/2007 Sheldon D24/217
D632,800 S * 2/2011 Nanni D24/217
D688,839 S * 8/2013 Helm D32/1
2014/0017118 A1 * 1/2014 Stoddard A61L 2/28
422/1

* cited by examiner

Primary Examiner — Anhdao Doan

(74) *Attorney, Agent, or Firm* — Jason D. Voight

(57) **CLAIM**

The ornamental design for an autoclave, as shown and described.

DESCRIPTION

FIG. 1 is a front view of an autoclave;
FIG. 2 is a rear view thereof;
FIG. 3 is a top view thereof;
FIG. 4 is a bottom view thereof;
FIG. 5 is a left side view thereof;
FIG. 6 is a right side view thereof; and,
FIG. 7 is a perspective view from upper right side thereof.
The broken lines are included for the purpose of illustrating portions of the autoclave that form no part of the claimed design.

1 Claim, 4 Drawing Sheets

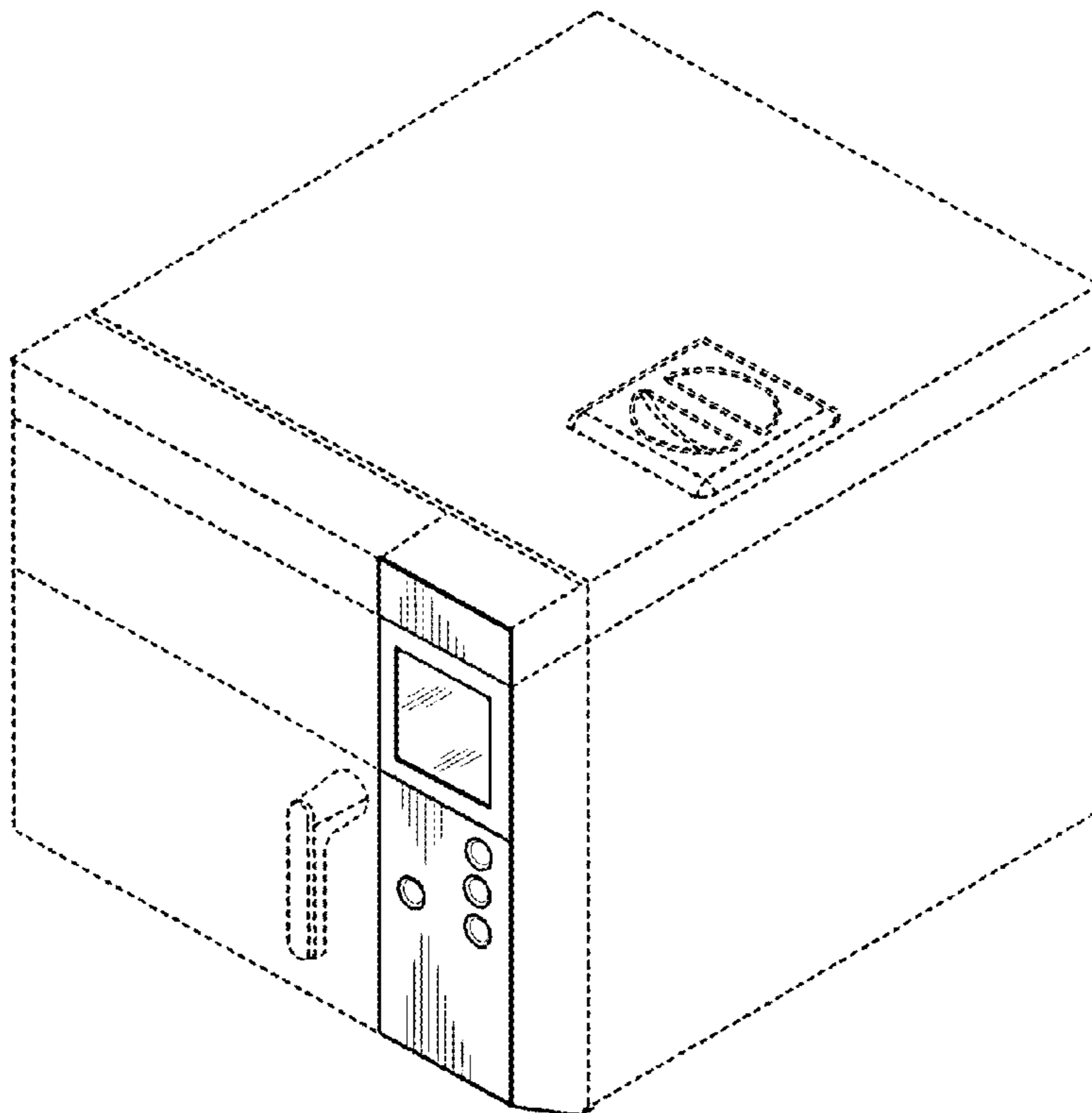

FIG. 1

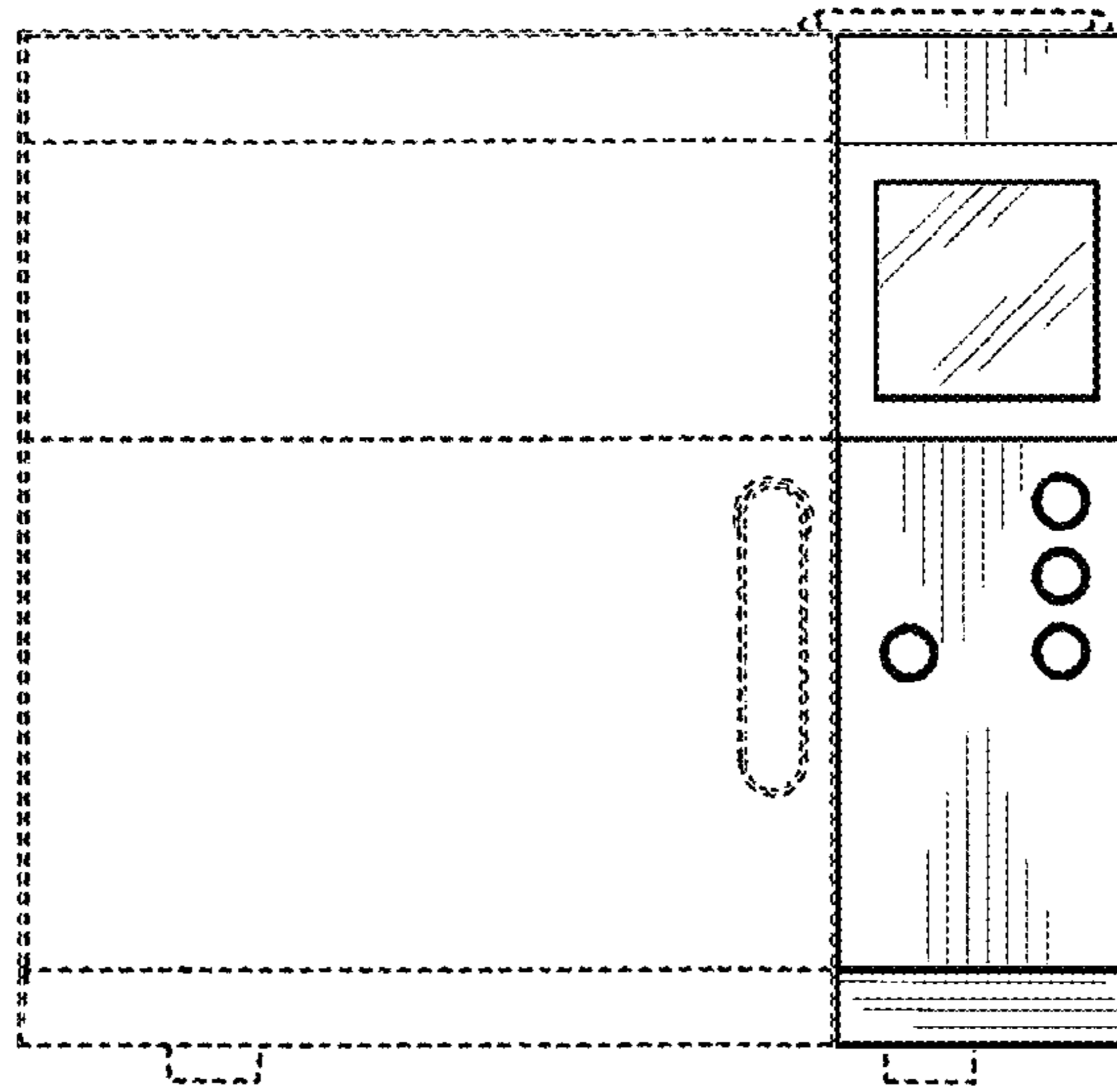

FIG. 2

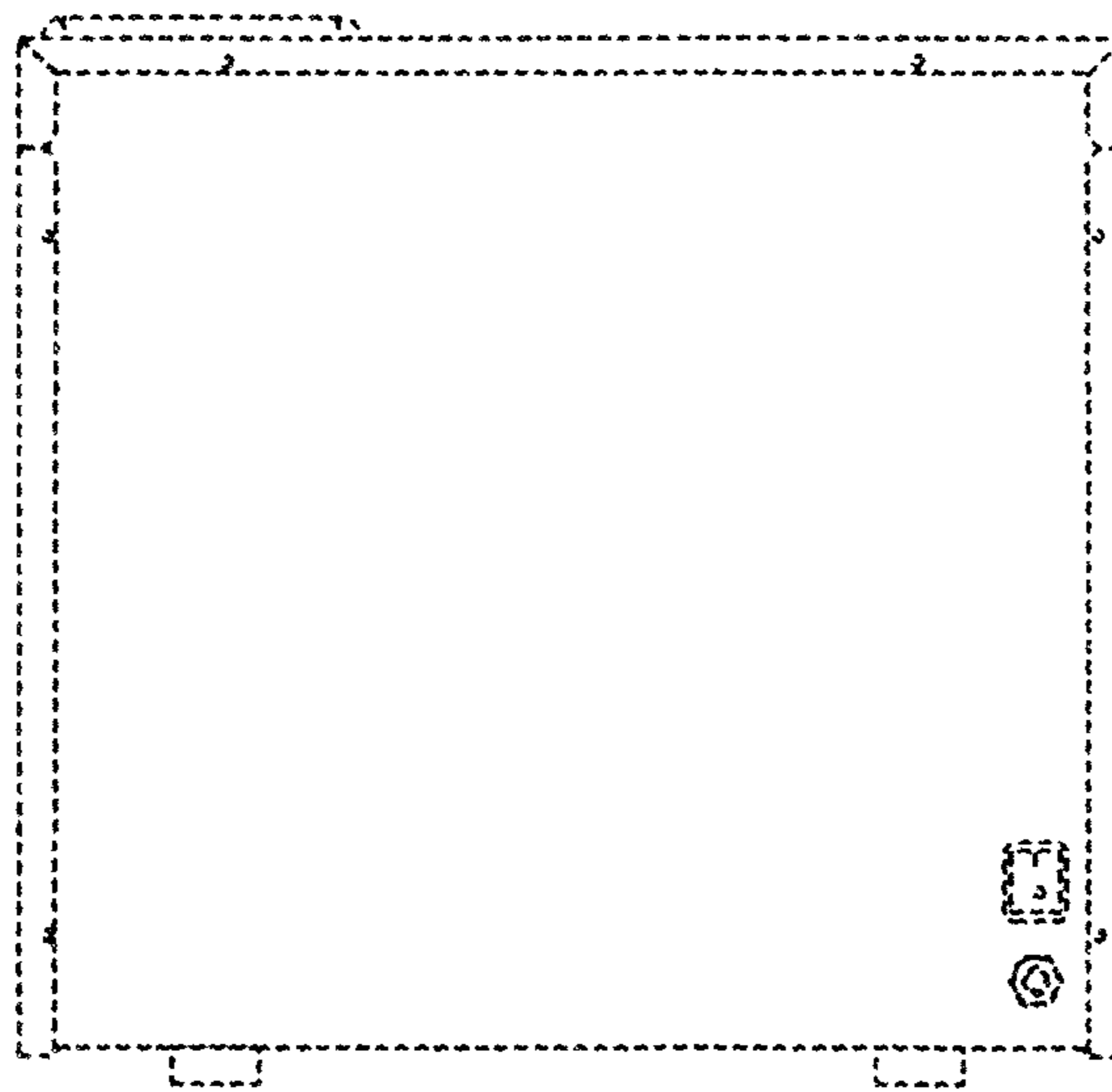

FIG. 3

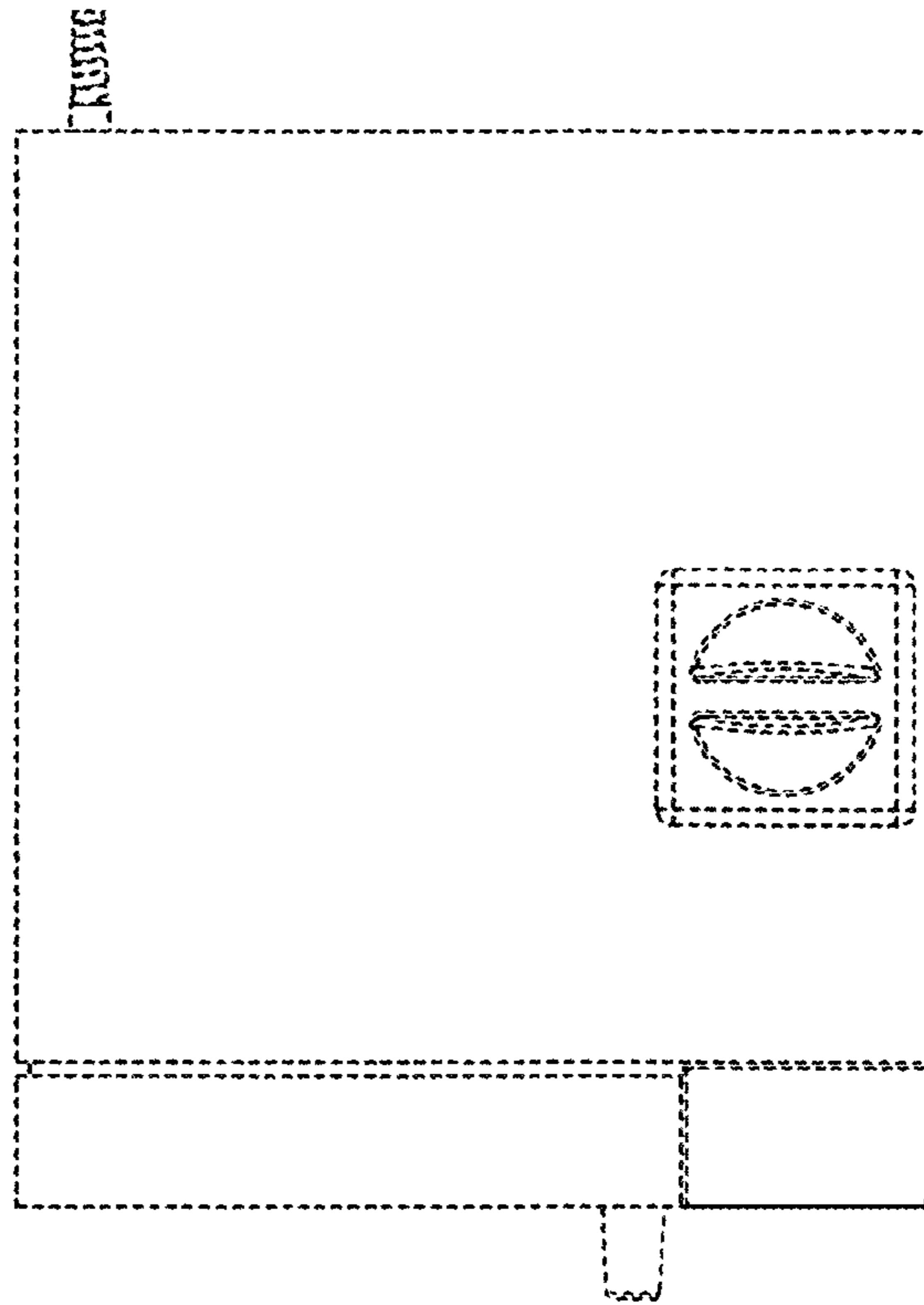

FIG. 4

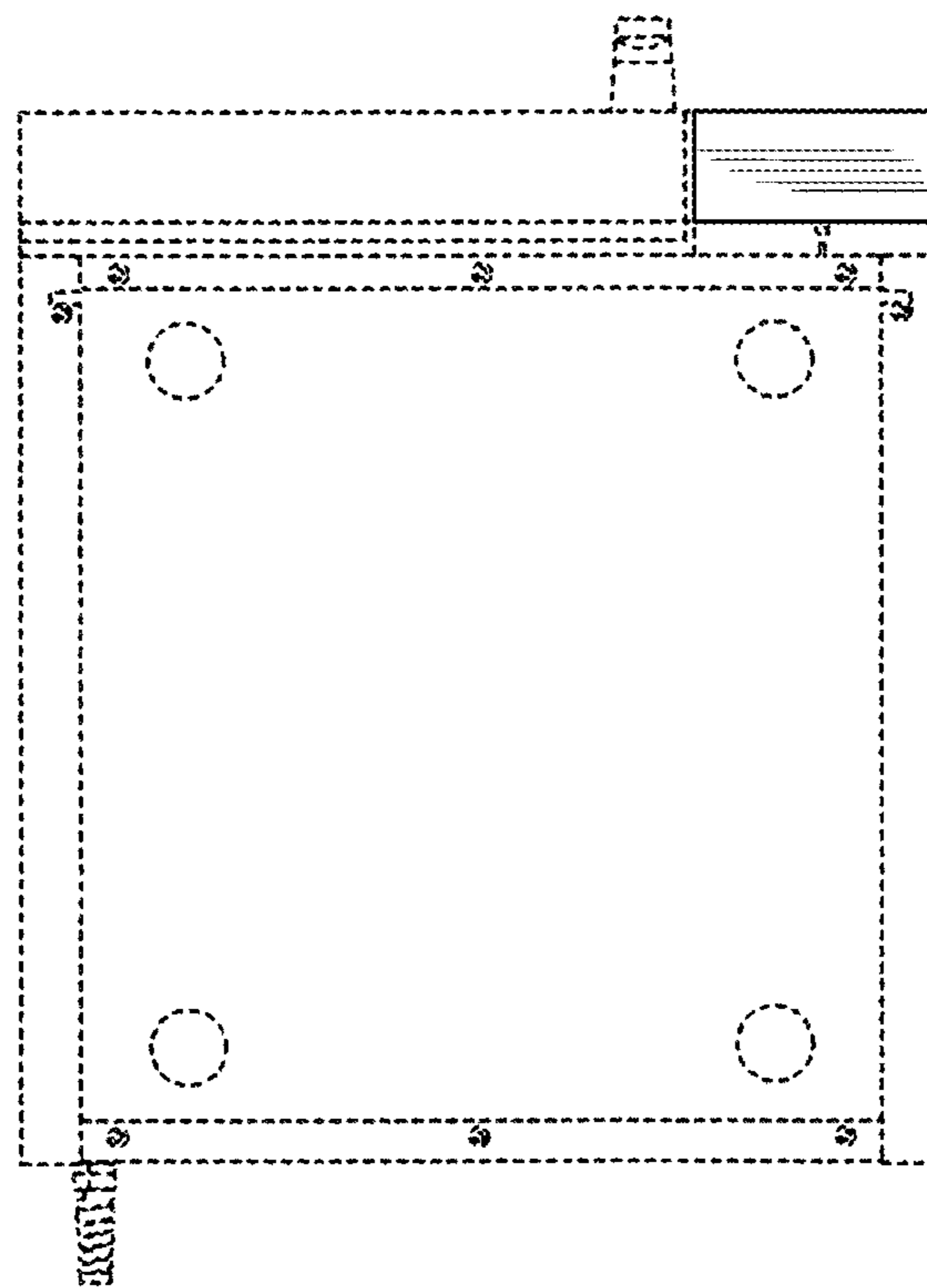

FIG. 5

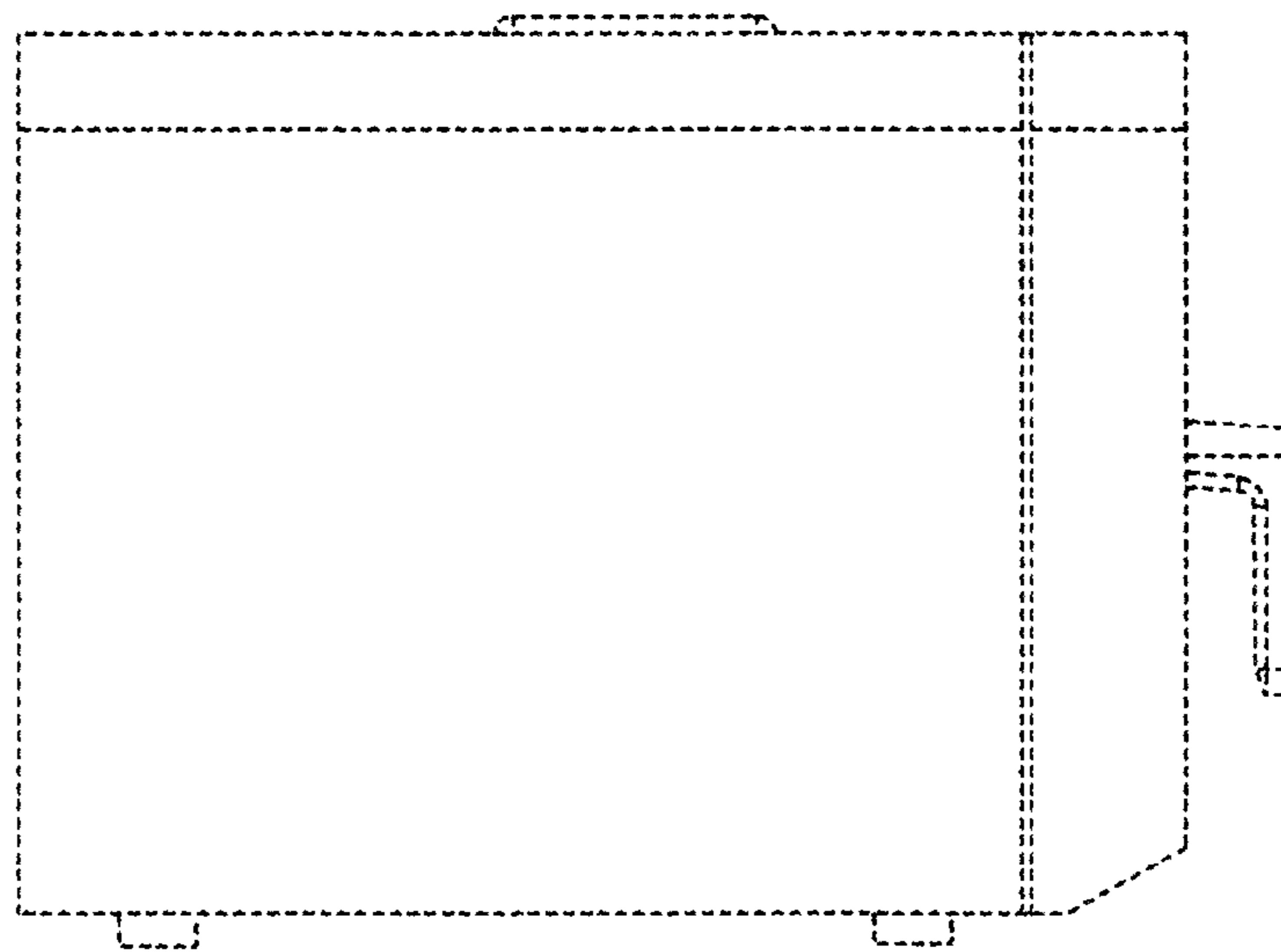

FIG. 6

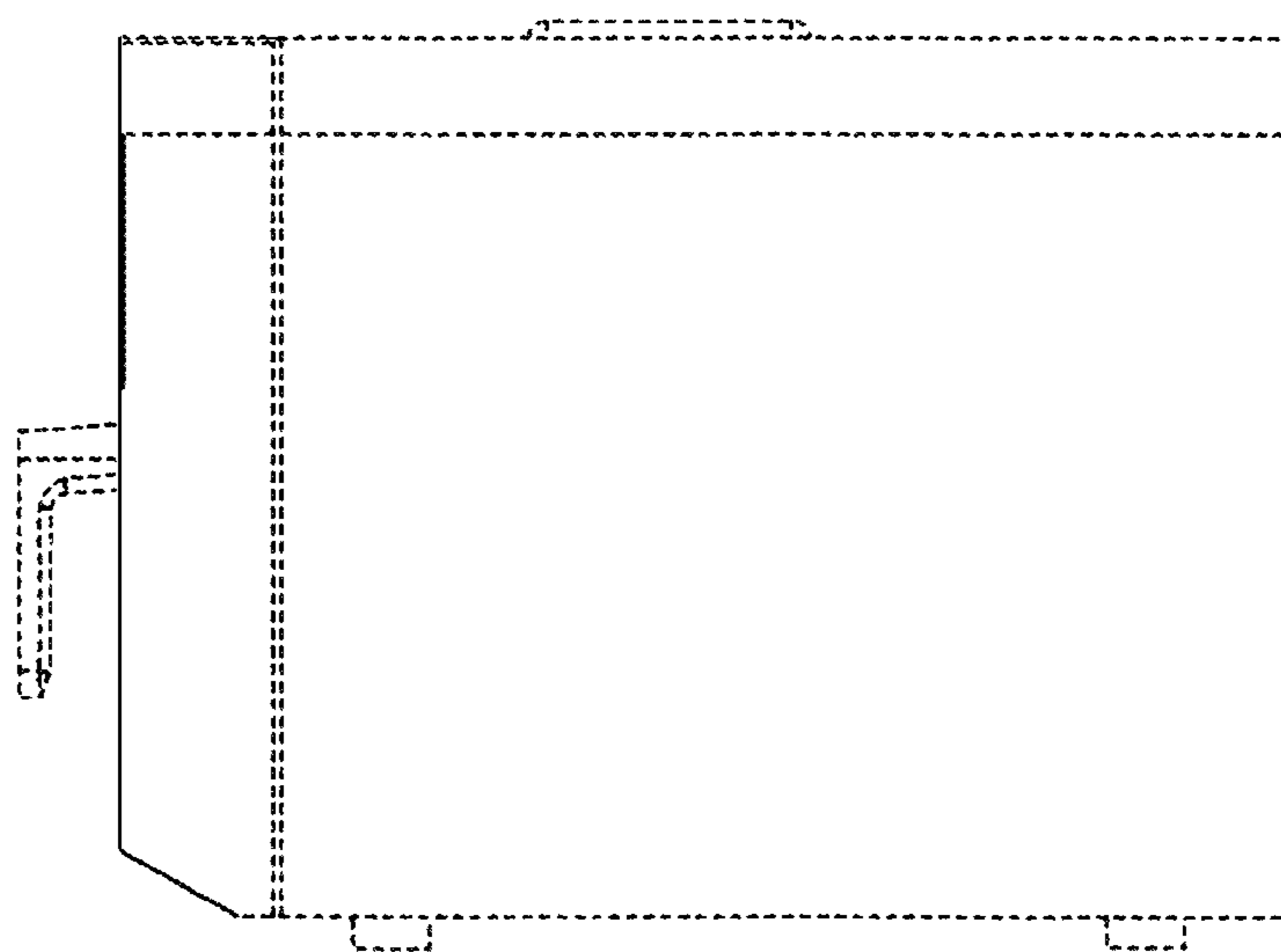

FIG. 7

