



US00D768300S

(12) **United States Design Patent**
Felix

(10) **Patent No.:** **US D768,300 S**
(45) **Date of Patent:** **** Oct. 4, 2016**

- (54) **ELECTRONIC WRISTBAND**
- (71) Applicant: **Wilfredo Felix**, Bronx, NY (US)
- (72) Inventor: **Wilfredo Felix**, Bronx, NY (US)
- (**) Term: **14 Years**
- (21) Appl. No.: **29/516,485**
- (22) Filed: **Feb. 3, 2015**
- (51) **LOC (10) Cl.** **24-02**
- (52) **U.S. Cl.**
USPC **D24/186; D14/344**
- (58) **Field of Classification Search**
USPC D24/165-168, 186, 187, 107, 231;
D10/70, 75, 98, 30-32, 38; D11/3-5;
D14/344, 138 R
CPC .. A61B 5/6802; A61B 5/681; A61B 5/6824;
A61B 2560/0412; A61B 2560/0431; A61B
2560/0443; A61B 2560/0462; A61B
2560/0468; A61B 5/02405; A61B 5/02411;
A61B 5/02427; A61B 5/02438; G08B
21/0211
See application file for complete search history.

- D508,738 S * 8/2005 Lodato D24/186
- D532,001 S * 11/2006 Burke D14/240
- D543,192 S * 5/2007 Jung D10/31
- D688,585 S * 8/2013 Ohnemus D11/3
- D711,002 S * 8/2014 Ohnemus D24/186
- D717,956 S * 11/2014 Alexander D24/167
- D725,068 S * 3/2015 Cho D14/138 R

* cited by examiner

Primary Examiner — Anhdao Doan

(57) **CLAIM**

The ornamental design for an electronic wristband, as shown and described.

DESCRIPTION

FIG. 1 is a perspective view of the electronic wristband; FIG. 2 is a bottom perspective view thereof; FIG. 3 is a rear perspective view thereof; FIG. 4 is a front plane view thereof; FIG. 5 is a rear plane view thereof; FIG. 6 is a left plane view thereof; FIG. 7 is a right plane view thereof; FIG. 8 is a top plane view thereof; FIG. 9 is a bottom plane view thereof; and, FIG. 10 shows how the electronic wristband is worn around the wrist.

The broken line showing an arm in FIG. 10 is included for the purpose of illustrating environmental structure and forms no part of the claimed design.

- (56) **References Cited**
U.S. PATENT DOCUMENTS
D273,009 S * 3/1984 Isaacs D24/187
D439,981 S * 4/2001 Kasabach D24/186

1 Claim, 10 Drawing Sheets

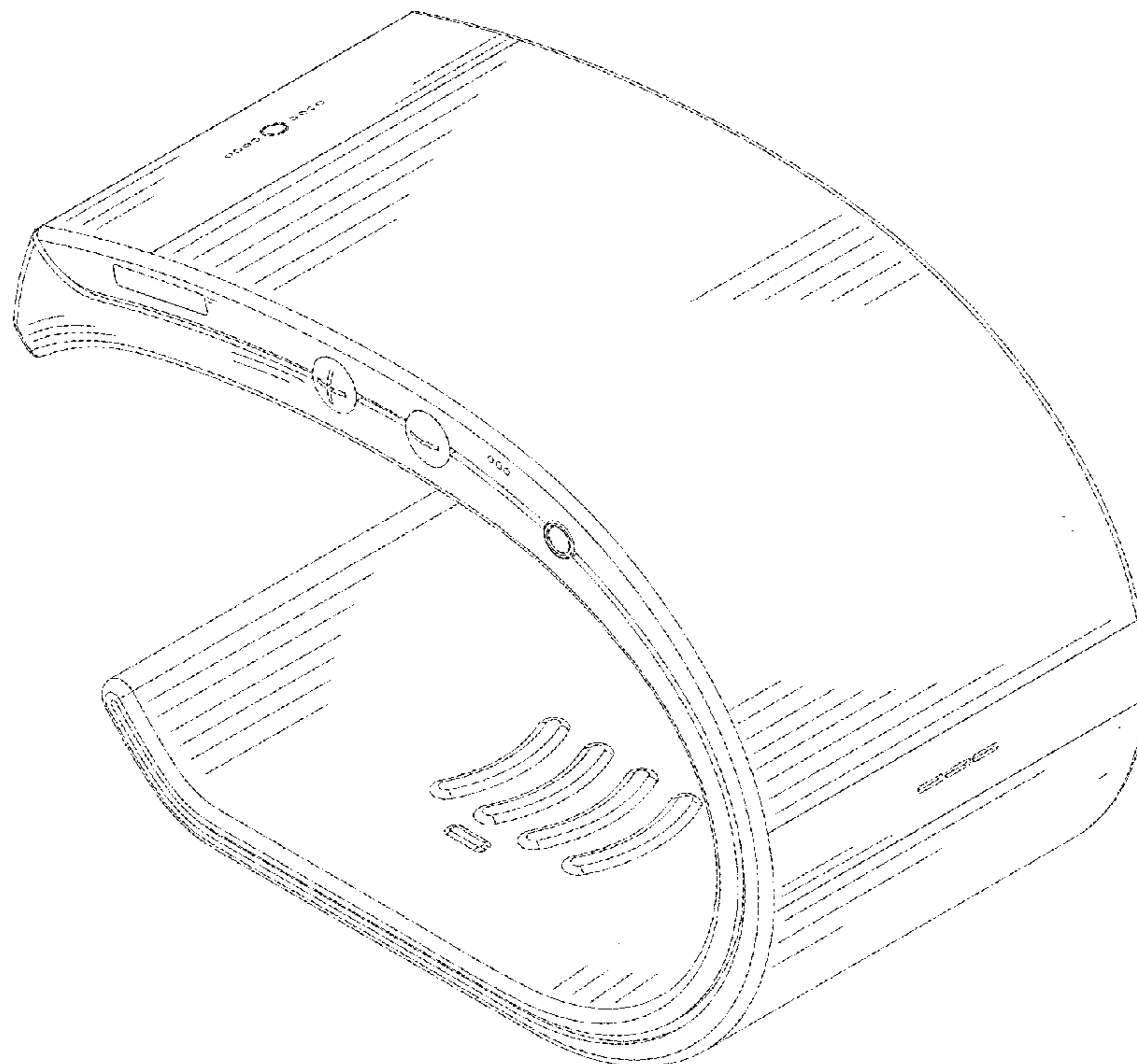

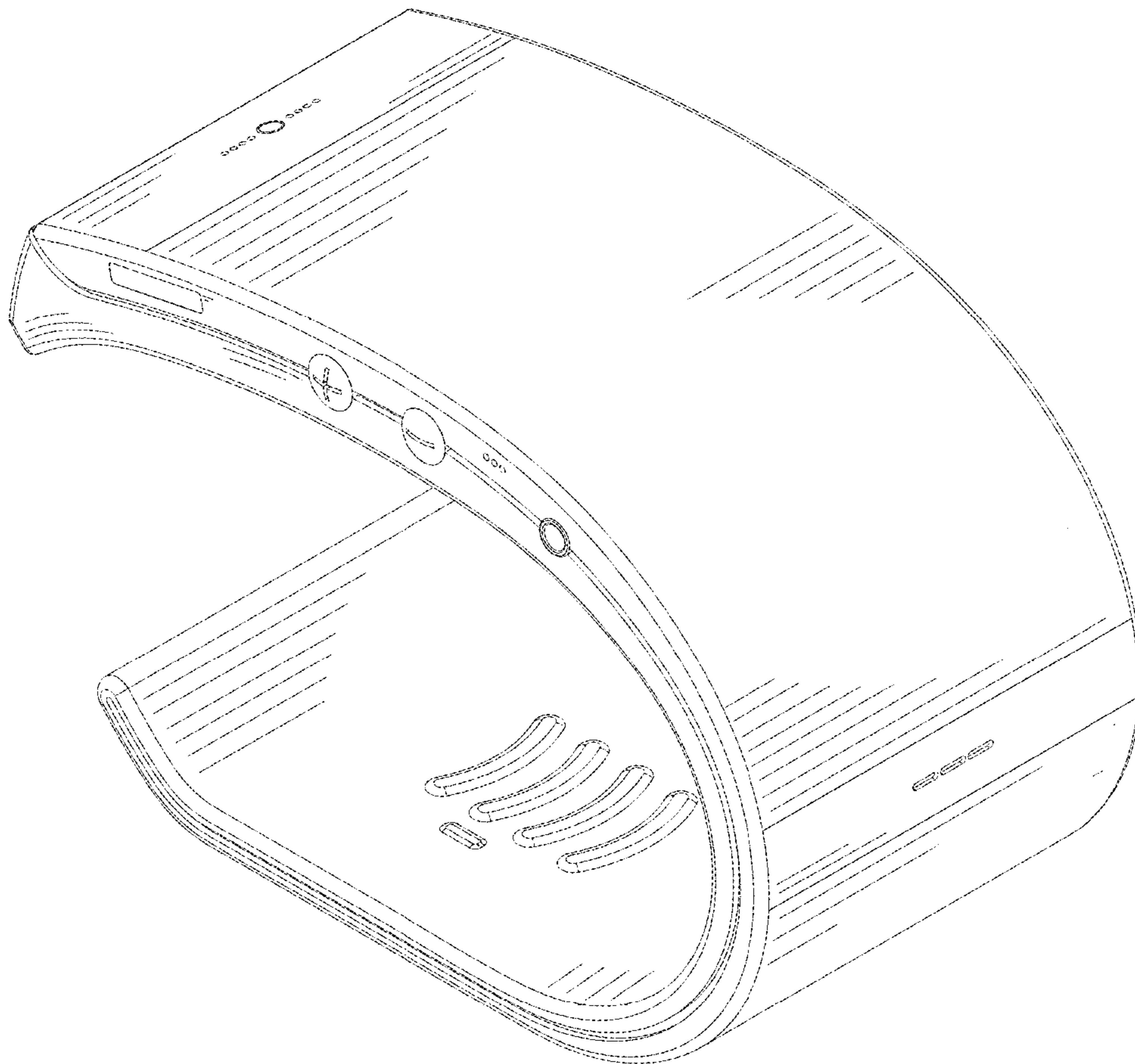

FIG. 1

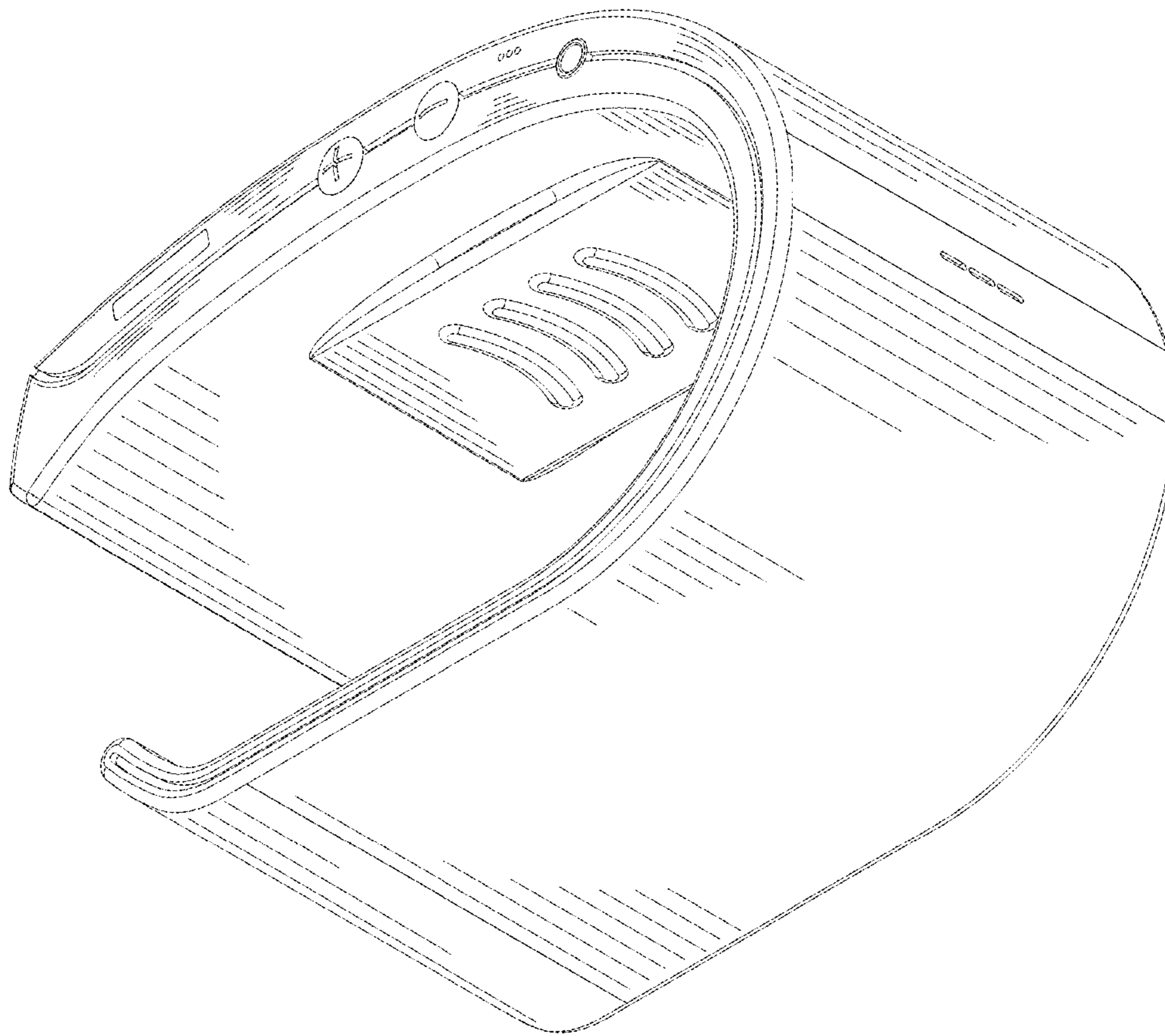

FIG. 2

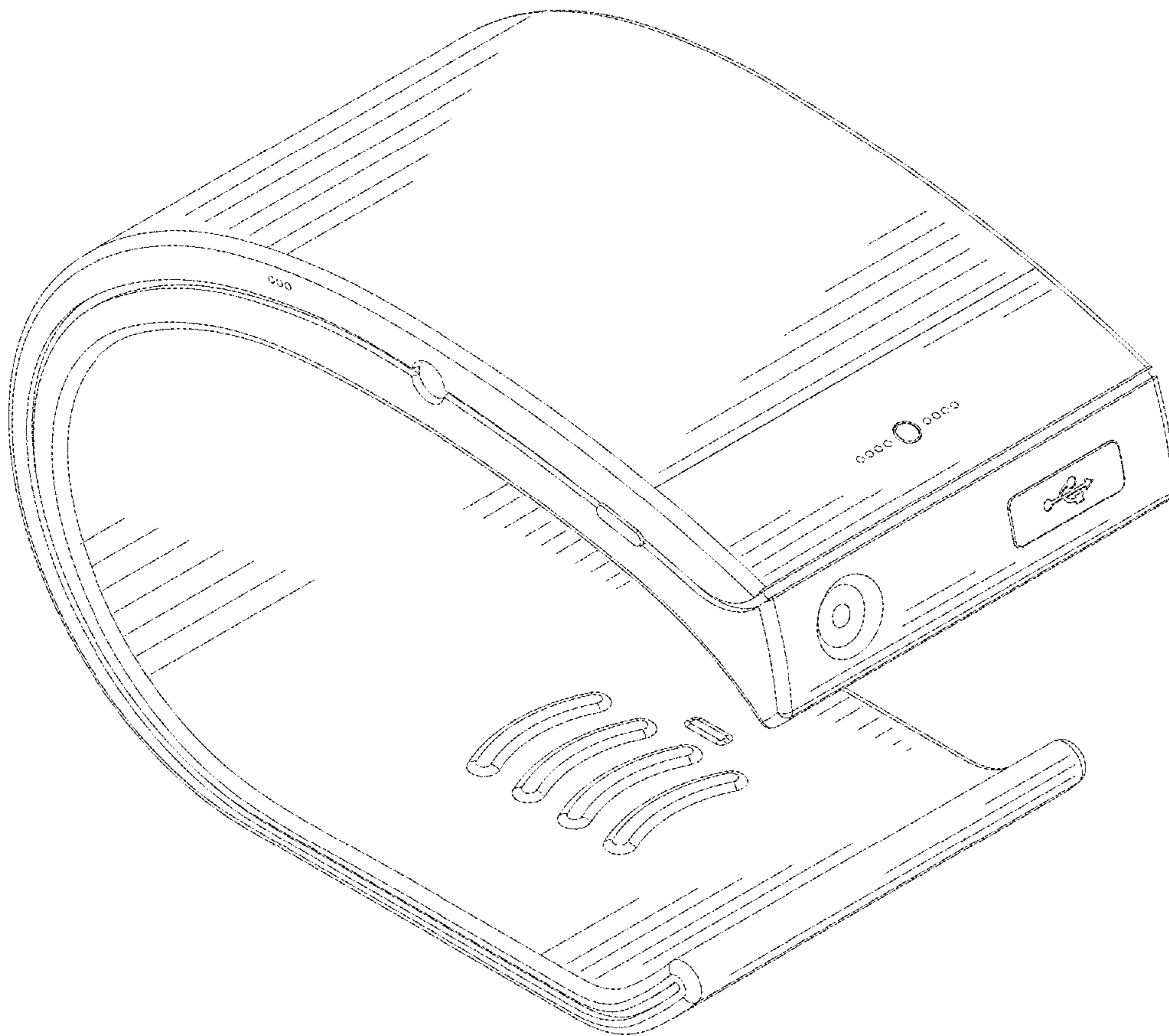

FIG. 3

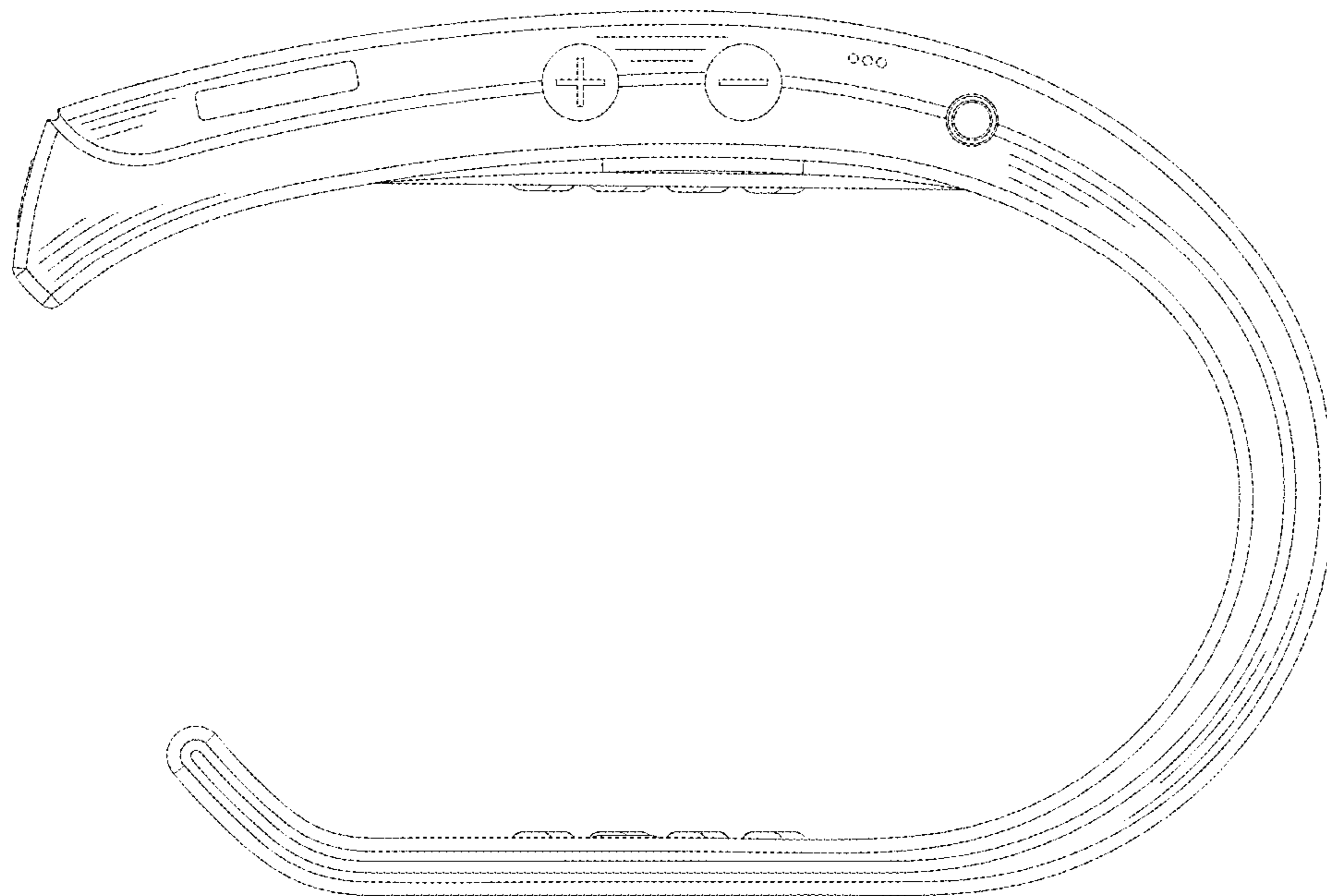

FIG. 4

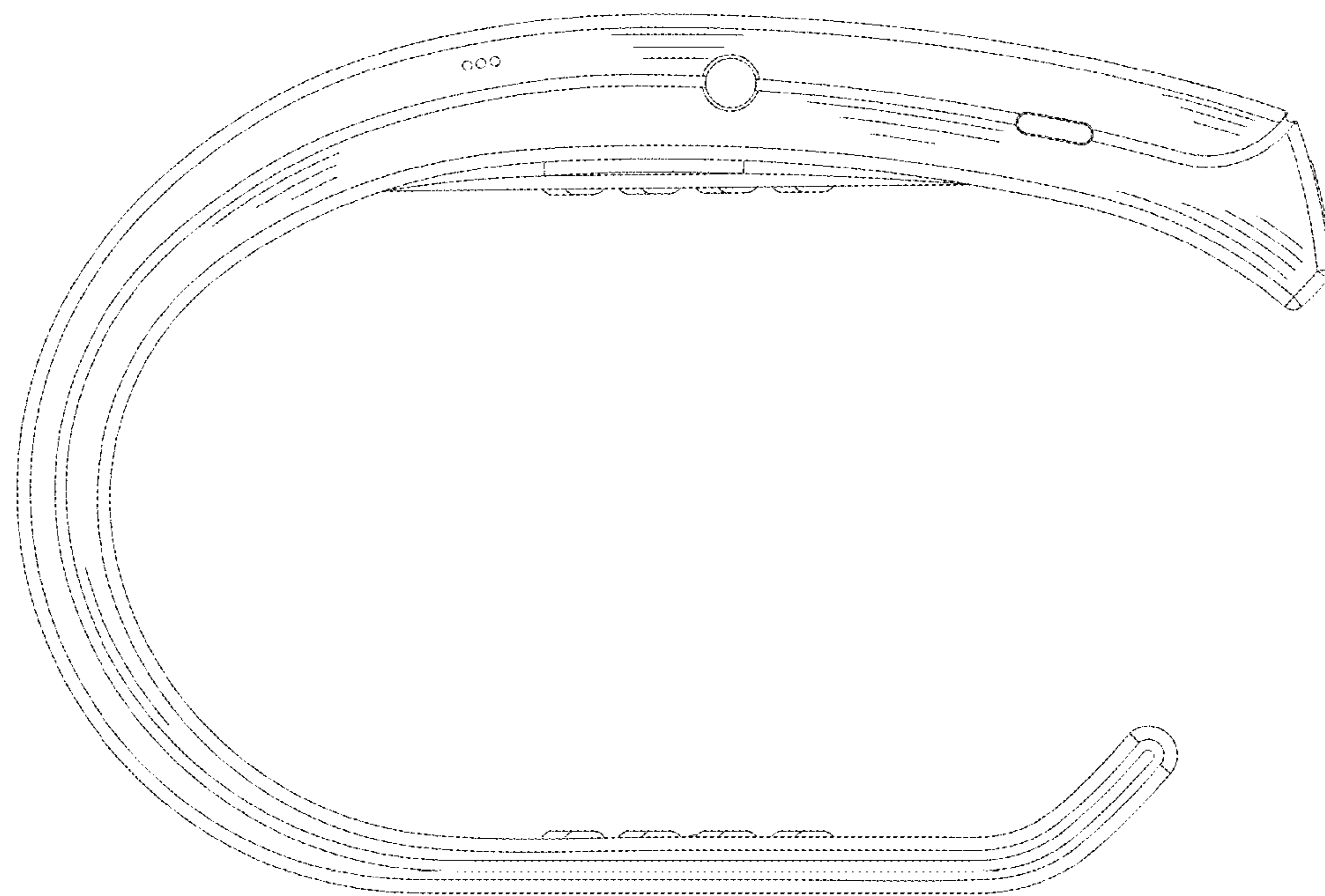

FIG. 5

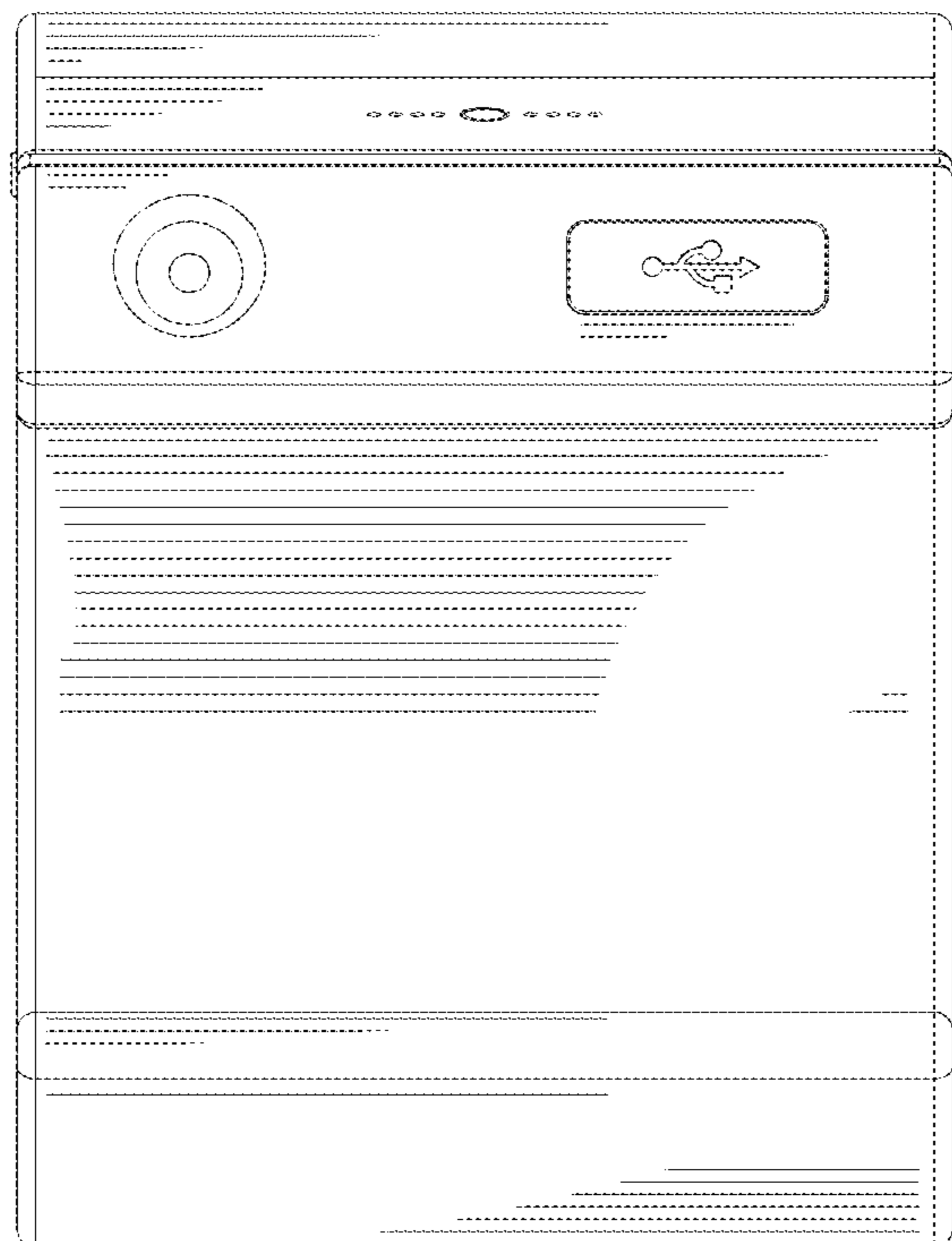

FIG. 6

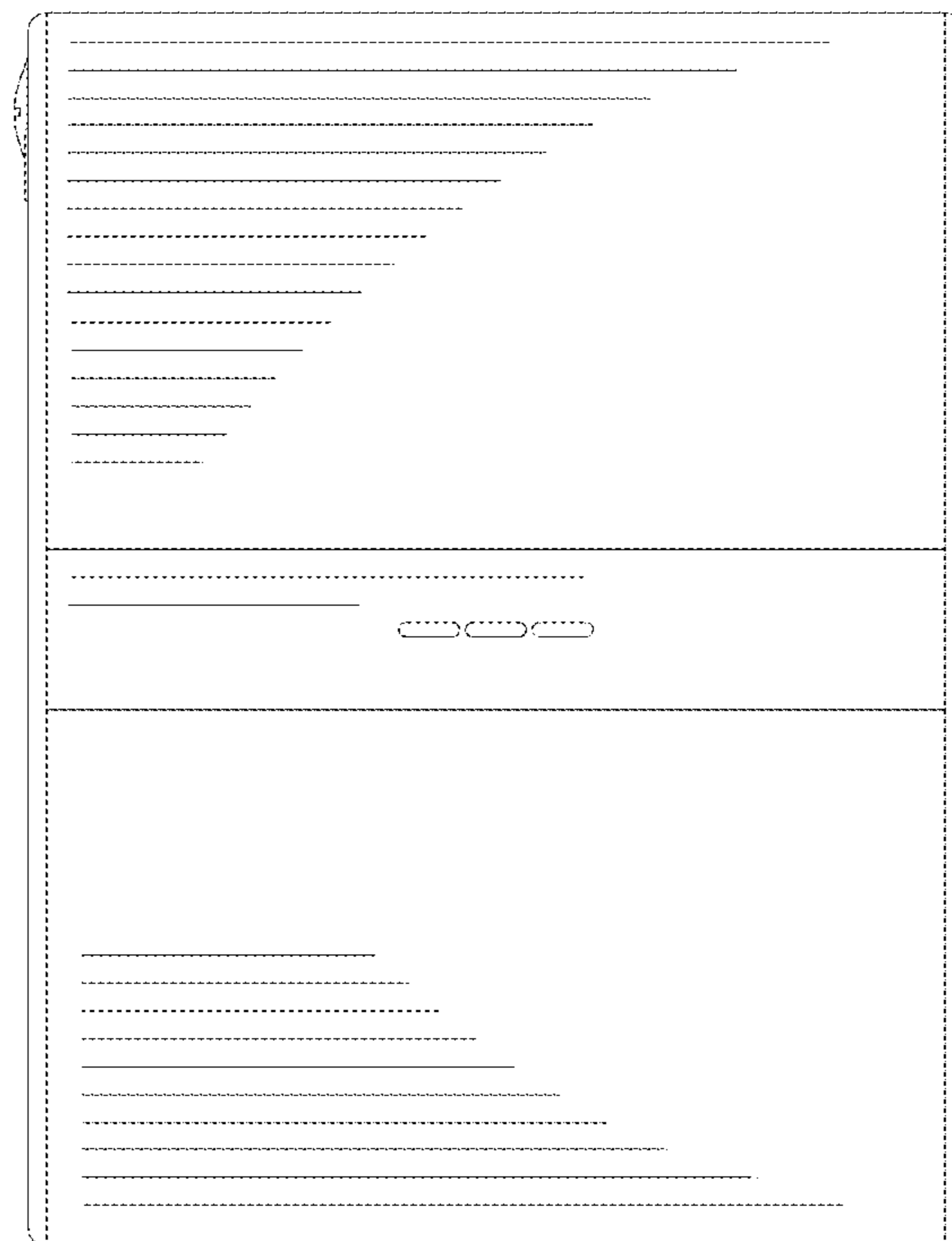

FIG. 7

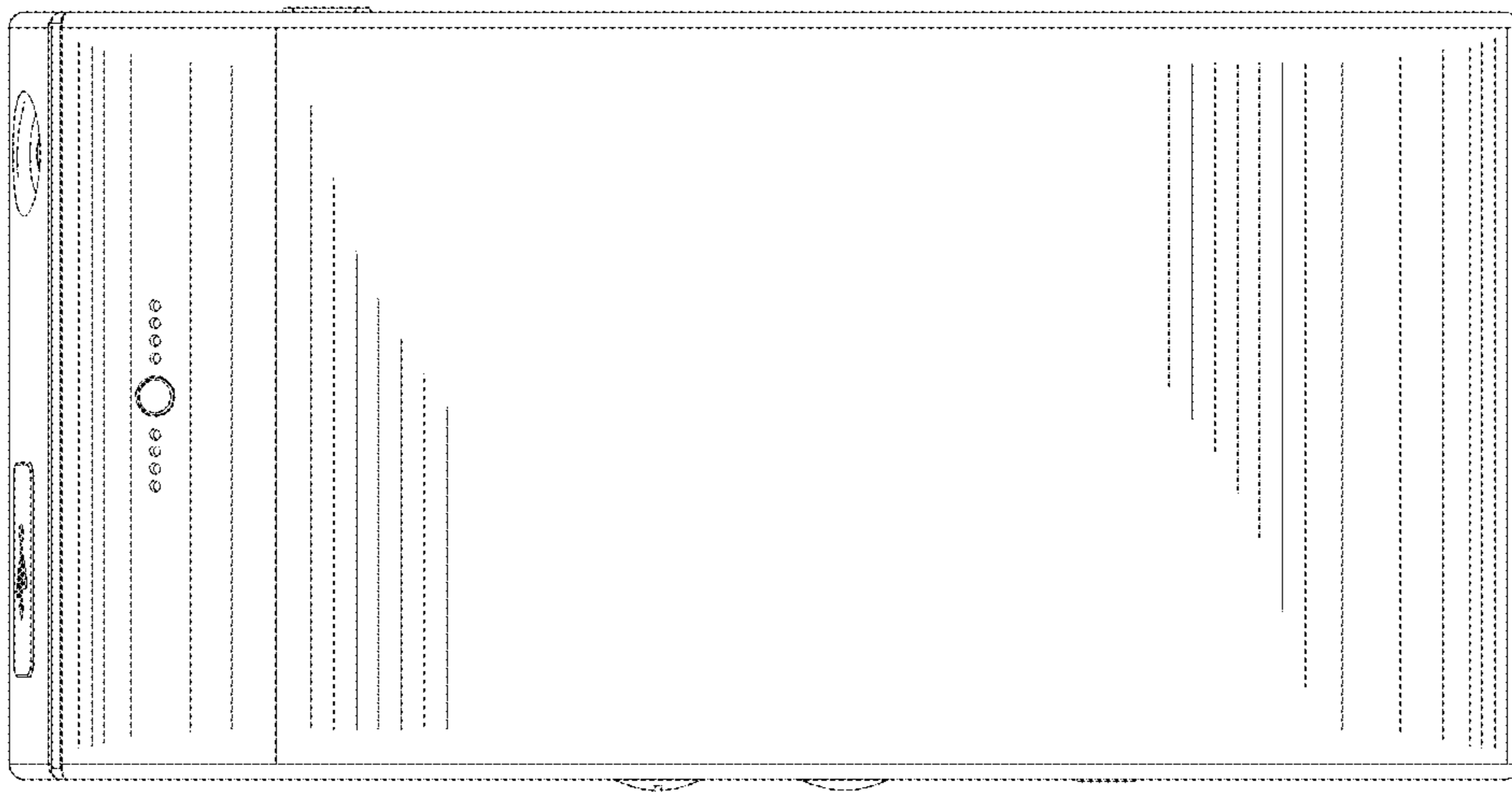

FIG. 8

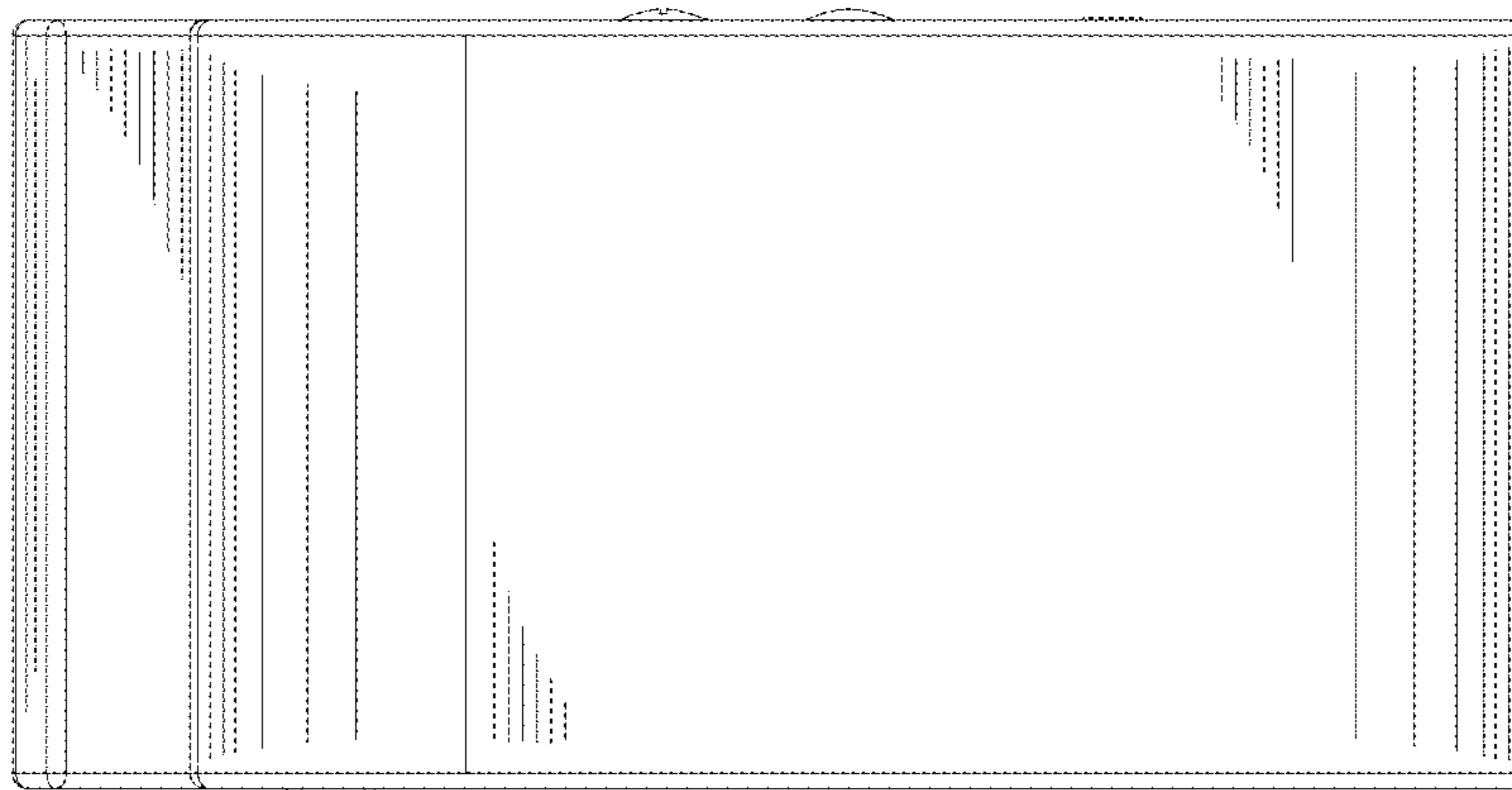

FIG. 9

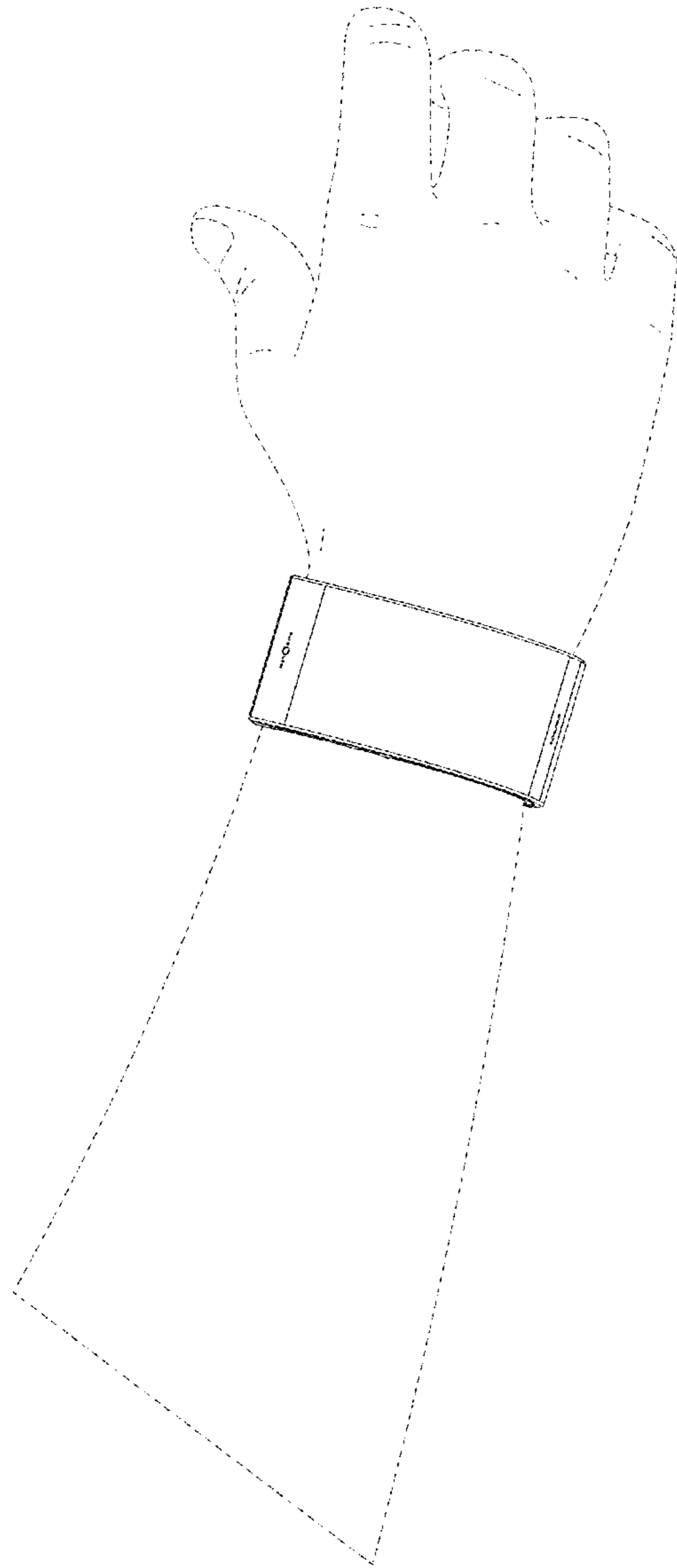

FIG. 10