



US00D768254S

(12) **United States Design Patent**
Geissele

(10) **Patent No.:** **US D768,254 S**

(45) **Date of Patent:** **** Oct. 4, 2016**

(54) **ARMORER TOOL**

(71) Applicant: **WHG Properties, LLC**, North Wales, PA (US)

(72) Inventor: **William H. Geissele**, Lower Gwynedd, PA (US)

(73) Assignee: **WHG Properties, LLC**, North Wales, PA (US)

(**) Term: **14 Years**

(21) Appl. No.: **29/514,275**

(22) Filed: **Jan. 9, 2015**

(51) **LOC (10) Cl.** **22-01**

(52) **U.S. Cl.**
USPC **D22/108**

(58) **Field of Classification Search**
USPC D22/108; D21/85-86
CPC B25B 13/48; B25B 13/04; B25B 13/50;
B25B 31/005; F41A 35/00
See application file for complete search history.

(56) **References Cited**

U.S. PATENT DOCUMENTS

7,143,670	B2 *	12/2006	Geary	B25B 13/481 81/177.2
7,325,469	B1 *	2/2008	Clampitt, Jr.	B25B 15/004 81/436
D614,931	S *	5/2010	Su	D8/86
8,113,297	B2 *	2/2012	Sakakibara	A25F 5/02 173/162.1
D687,284	S *	8/2013	Liu	D8/71

2010/0274298	A1 *	10/2010	Schiff	A61B 17/8875 606/329
2013/0187025	A1 *	7/2013	Lawrence	B25B 15/001 249/187.1
2014/0033590	A1 *	2/2014	Gomez	F41A 21/48 42/75.02

OTHER PUBLICATIONS

<https://www.botach.com/kley-zion-armors-ar15-m4-barrel-spline-socket-rod/> (retrieved Jul. 10, 2015).
<http://geissele.com/reaction-rod.html> (retrieved Jul. 10, 2015).

* cited by examiner

Primary Examiner — Michael A Pratt

(57) **CLAIM**

The ornamental design for an armorer tool, as shown and described.

DESCRIPTION

FIG. 1 is a front, left side perspective view of an embodiment of an armorer tool according to the present disclosure; FIG. 2 is a left side view of the embodiment of FIG. 1; FIG. 3 is a right side view of the embodiment of FIG. 1; FIG. 4 is a top view of the embodiment of FIG. 1; FIG. 5 is a bottom view of the embodiment of FIG. 1; FIG. 6 is a front view of the embodiment of FIG. 1; FIG. 7 is a rear view of the embodiment of FIG. 1; FIG. 8 is a front, left side perspective view of a further embodiment of an armorer tool according to the present disclosure; FIG. 9 is a left side view of the embodiment of FIG. 8; FIG. 10 is a right side view of the embodiment of FIG. 8; FIG. 11 is a top view of the embodiment of FIG. 8; FIG. 12 is a bottom view of the embodiment of FIG. 8; FIG. 13 is a front view of the embodiment of FIG. 8; and, FIG. 14 is a rear view of the embodiment of FIG. 8. The broken lines in the Figures are for illustrative purposes only and form no part of the claimed design.

1 Claim, 6 Drawing Sheets

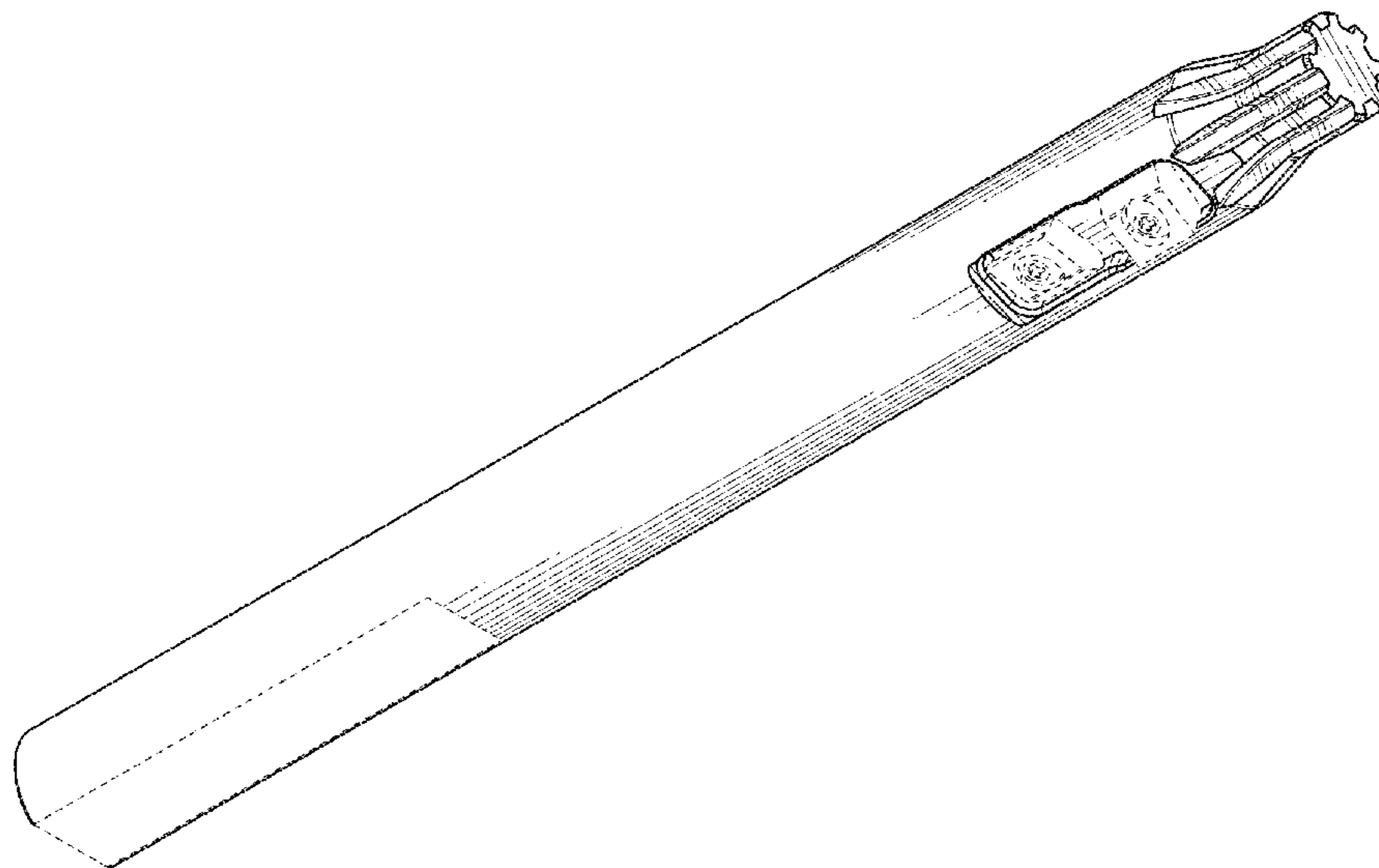

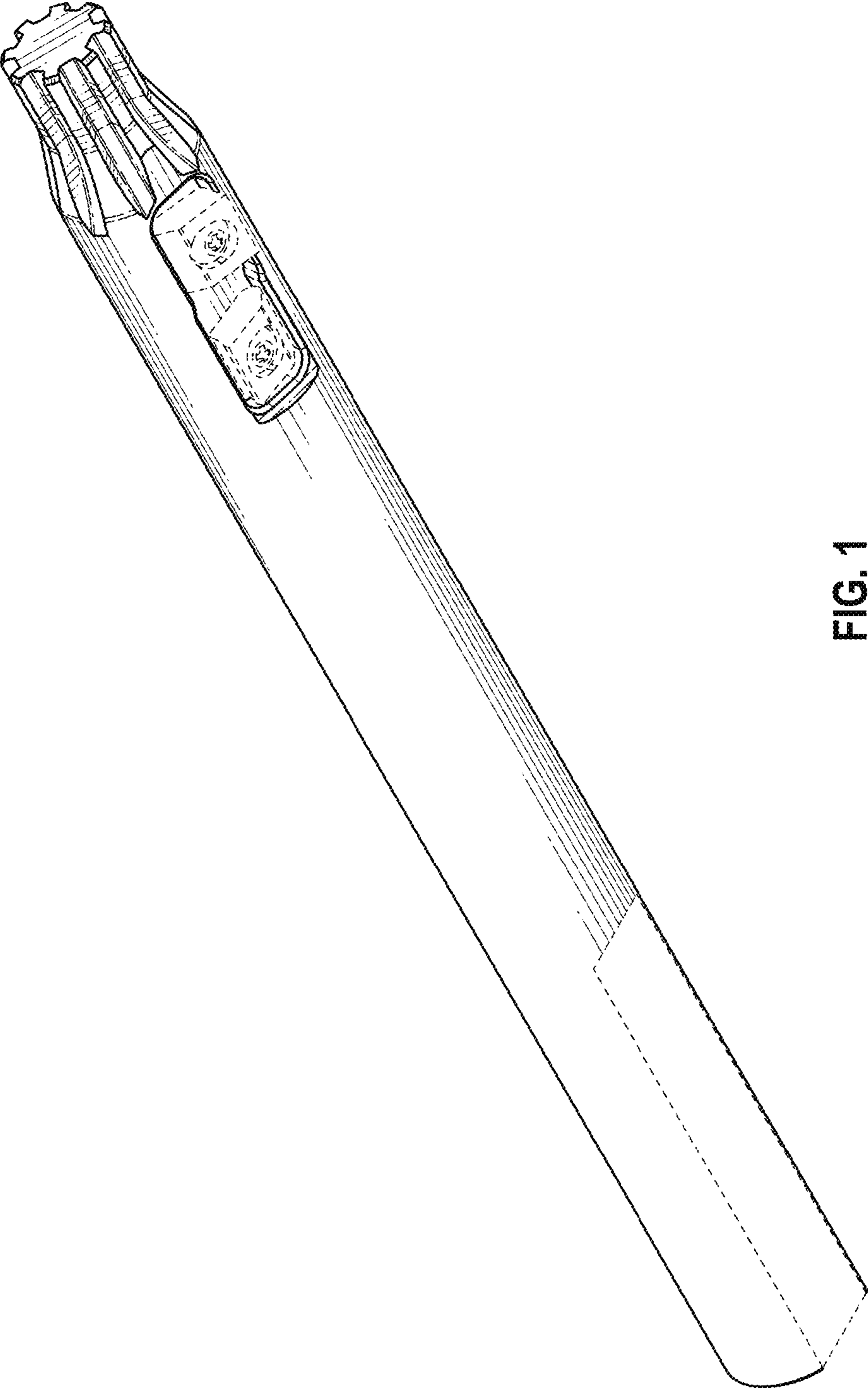

FIG. 1

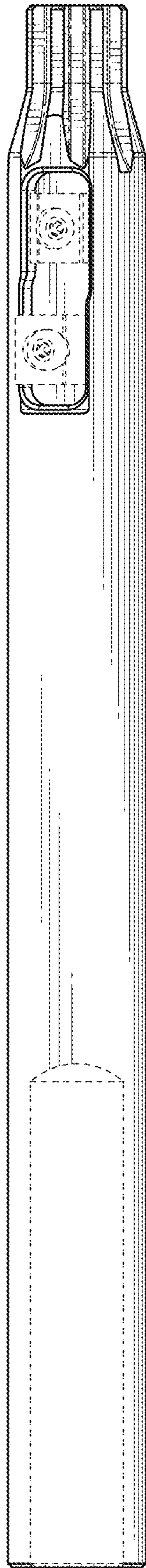

FIG. 2

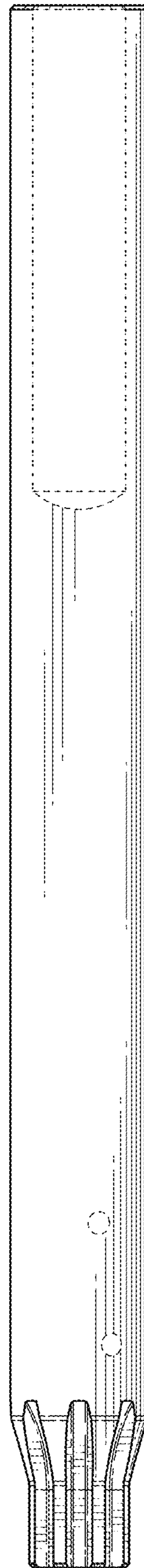

FIG. 3

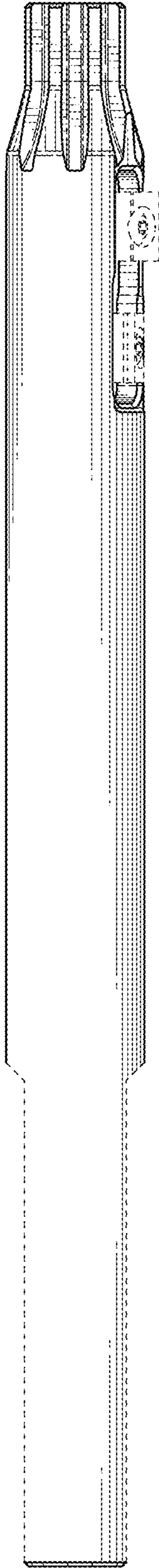

FIG. 4

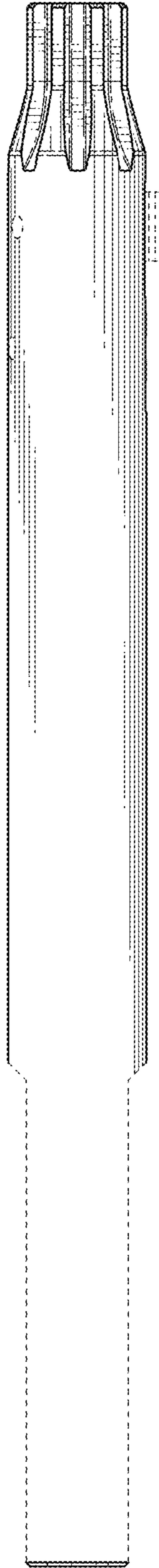

FIG. 5

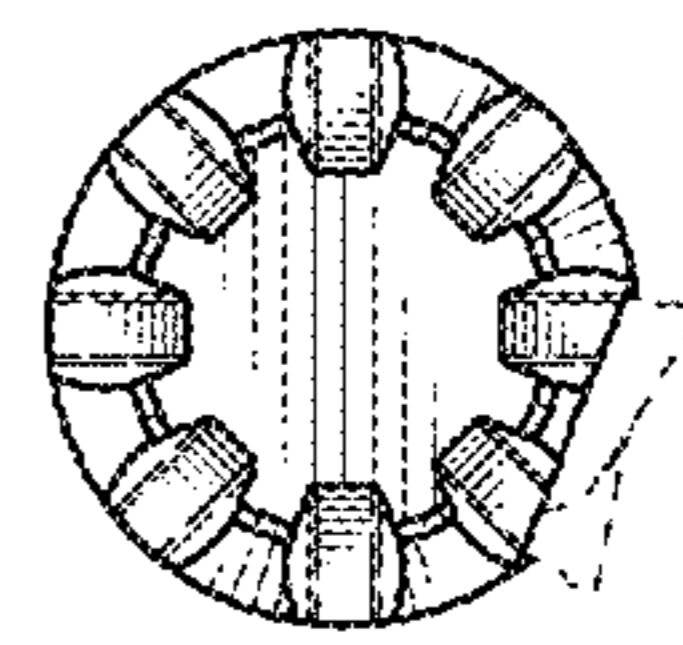

FIG. 6

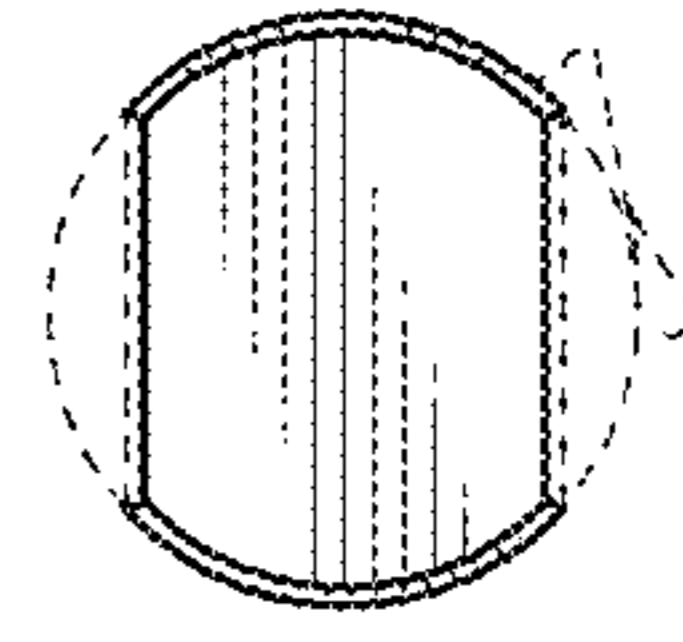

FIG. 7

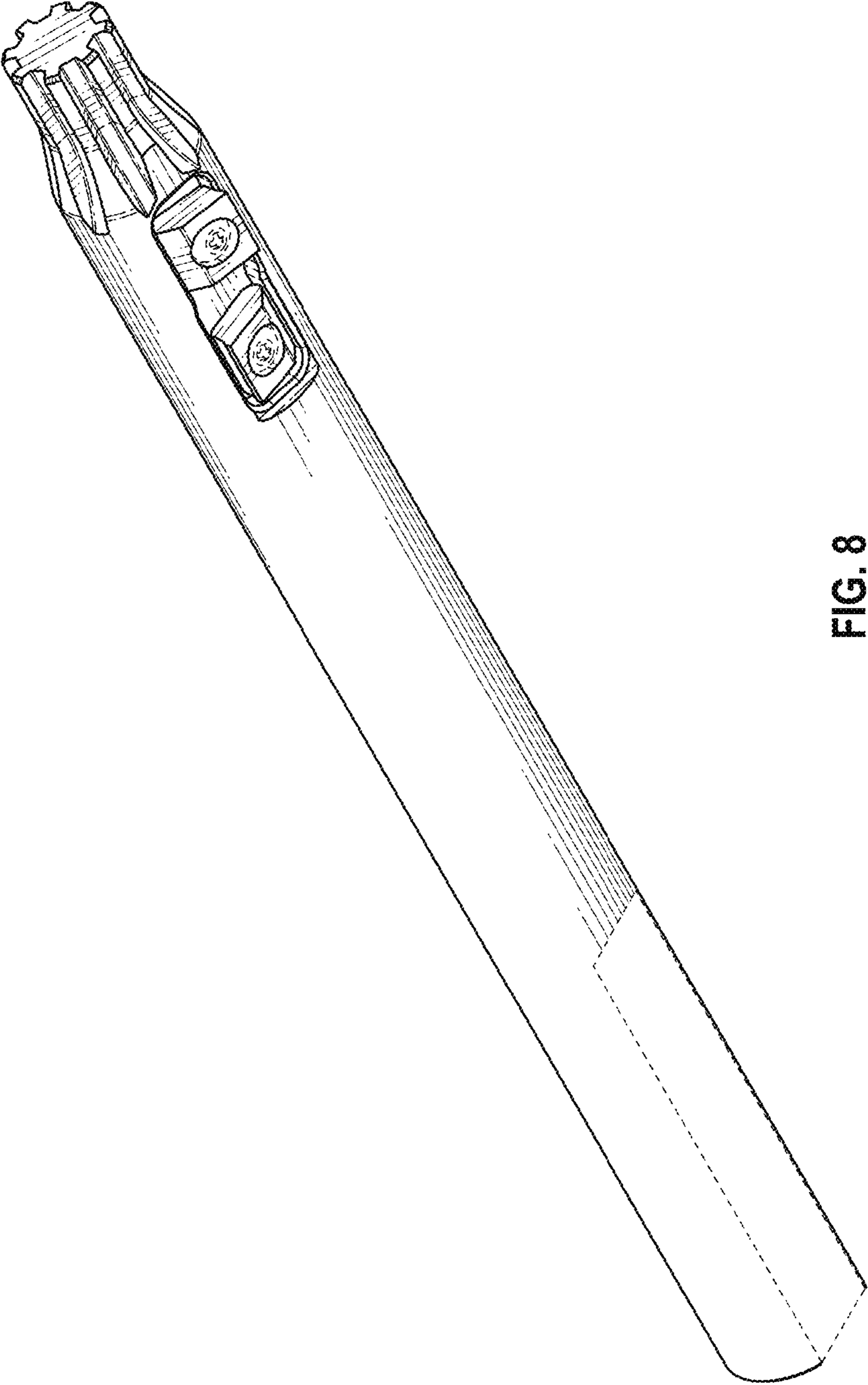

FIG. 8

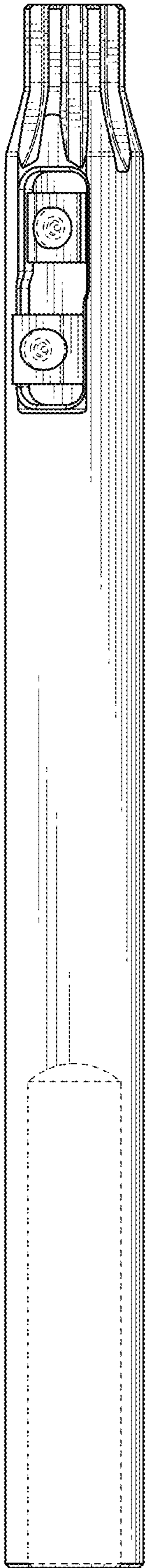

FIG. 9

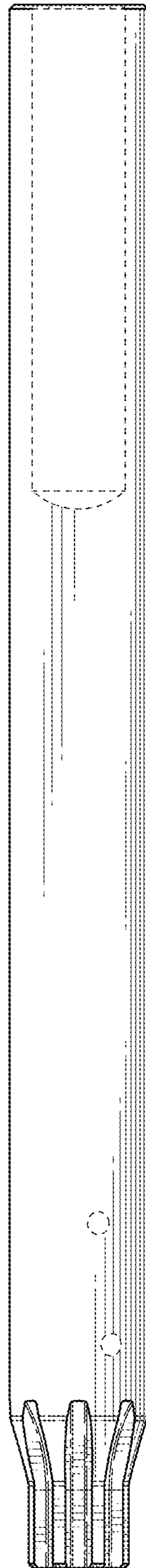

FIG. 10

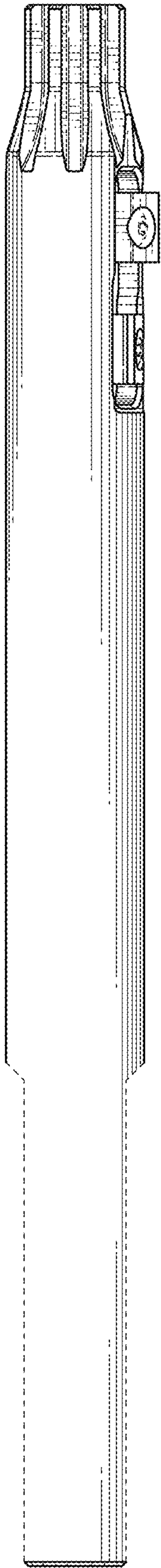

FIG. 11

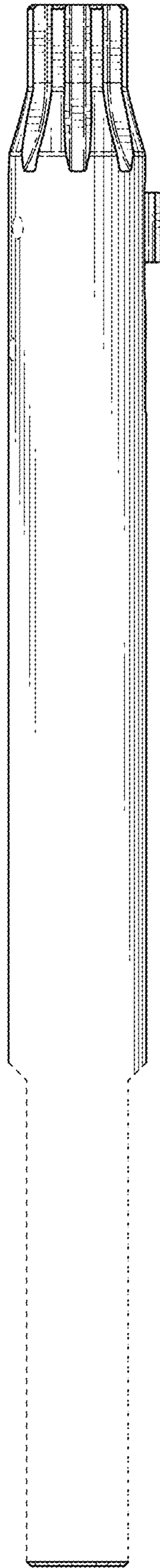

FIG. 12

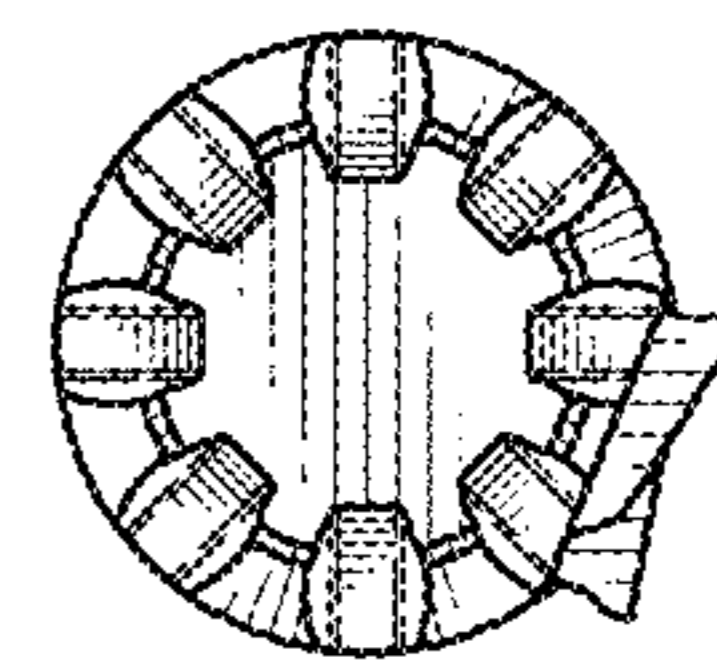

FIG. 13

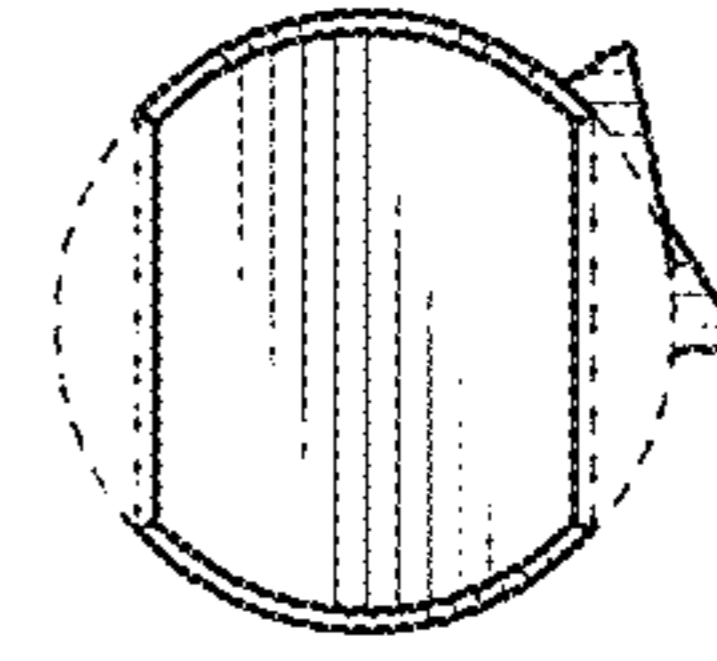

FIG. 14