



US00D768239S

(12) **United States Design Patent**
Shen

(10) **Patent No.:** **US D768,239 S**

(45) **Date of Patent:** **** Oct. 4, 2016**

(54) **ERASER**
(71) Applicant: **Ching Tai Shen**, Shanghai (CN)
(72) Inventor: **Ching Tai Shen**, Shanghai (CN)
(73) Assignee: **Shanghai FLOMO Fancy Stationery Co., Ltd.**, Shanghai (CN)
(**) Term: **14 Years**

D497,037 S *	10/2004	Rodriguez	D28/82
D505,865 S *	6/2005	Seizer	D9/688
D517,738 S *	3/2006	Lai	D28/82
D548,585 S *	8/2007	Okabe	D9/420
D568,692 S *	5/2008	Lam	D7/629
D586,397 S *	2/2009	Farnworth	D19/187
D587,753 S *	3/2009	Farnworth	D19/187
D590,444 S *	4/2009	Farnworth	D19/189
D599,958 S *	9/2009	Washington	D28/82
D623,936 S *	9/2010	Britt	D9/420
D645,749 S *	9/2011	Lee	D9/454
D705,354 S *	5/2014	Shen	D19/73

(21) Appl. No.: **29/524,467**
(22) Filed: **Apr. 21, 2015**
(51) **LOC (10) Cl.** **19-06**
(52) **U.S. Cl.**
USPC **D19/187**
(58) **Field of Classification Search**
USPC D14/411; D19/115-204
CPC B43K 5/005; B43K 5/16; B43K 7/00;
B43K 7/10; B43K 7/12; B43K 8/02; B43K
8/022; B43K 8/024; B43K 8/04; B43L
19/00; B43L 19/0056; B43L 19/0068
See application file for complete search history.

* cited by examiner

Primary Examiner — Elizabeth Albert

(57) **CLAIM**
The ornamental design for an eraser, as shown and described.

DESCRIPTION

FIG. 1 is a perspective view of the eraser showing my new design;
FIG. 2 is a perspective view thereof, folded out in open position;
FIG. 3 is the left side view of FIG. 1;
FIG. 4 is the right side view thereof;
FIG. 5 is the top plan view thereof;
FIG. 6 is the bottom plan view thereof;
FIG. 7 is the front elevational view thereof; and,
FIG. 8 is the rear elevational view thereof.

(56) **References Cited**
U.S. PATENT DOCUMENTS
D469,125 S * 1/2003 Jacquet D19/187
D479,689 S * 9/2003 Altonen D9/516
D480,634 S * 10/2003 Caroen D9/414

1 Claim, 8 Drawing Sheets

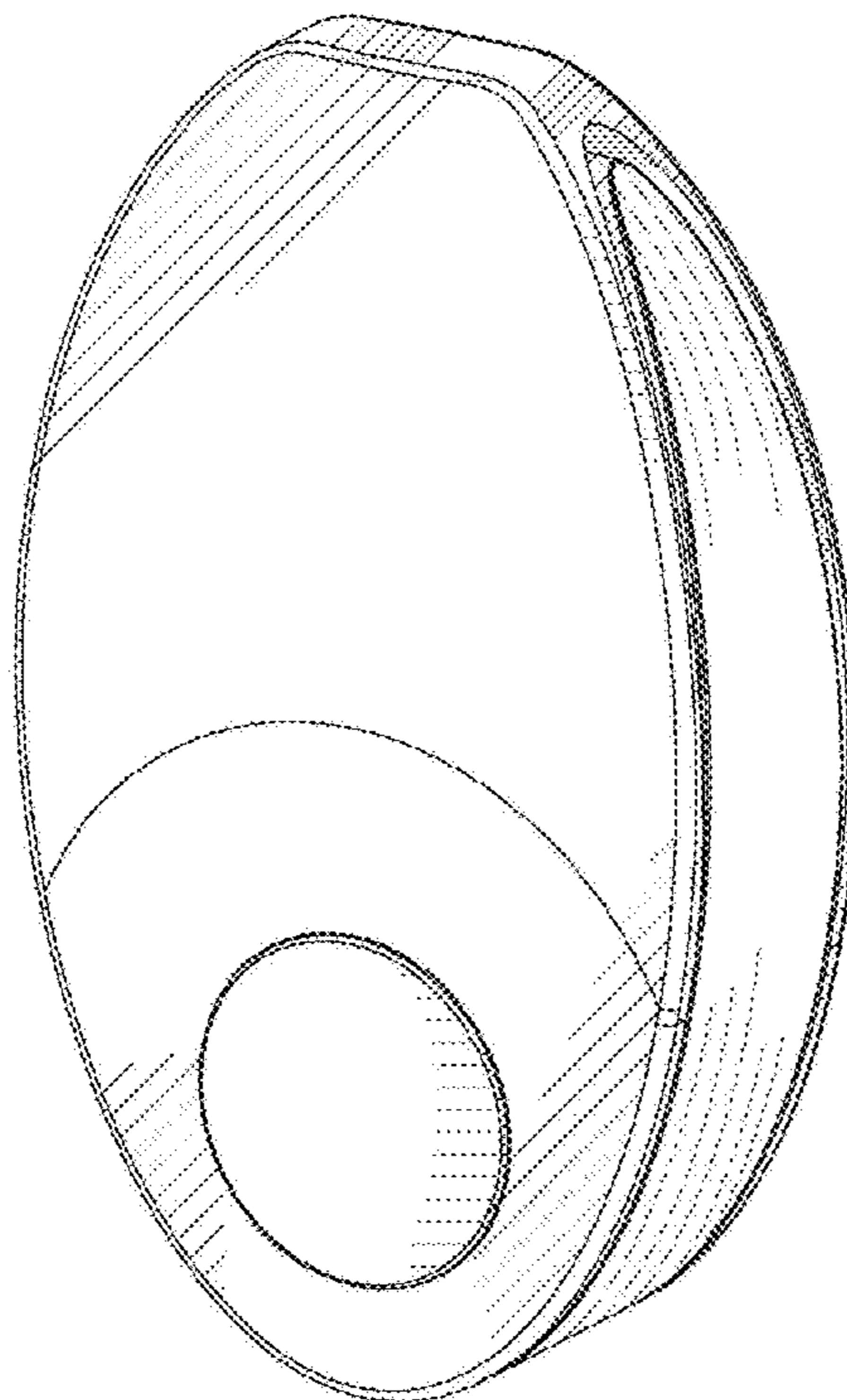

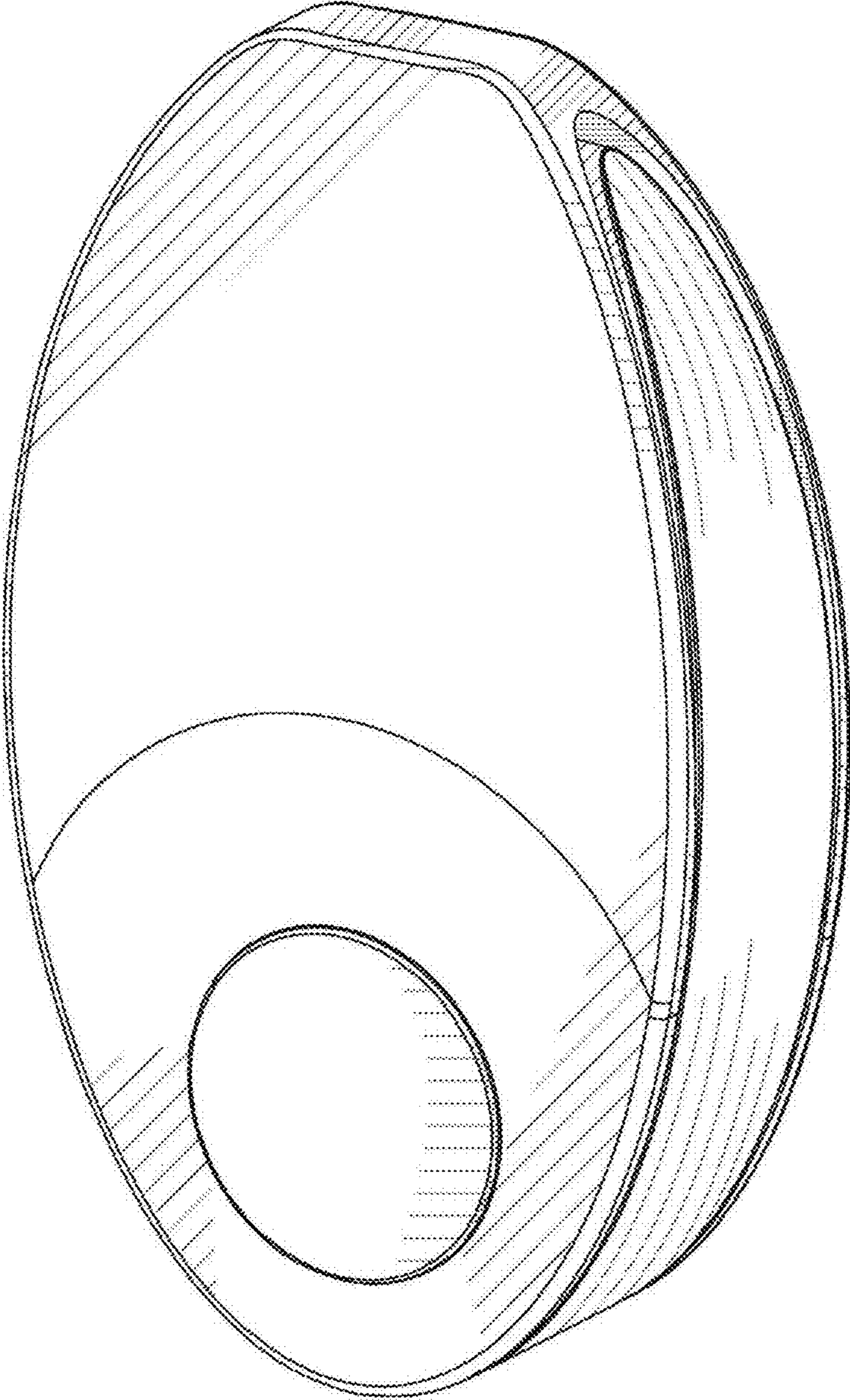

Fig. 1

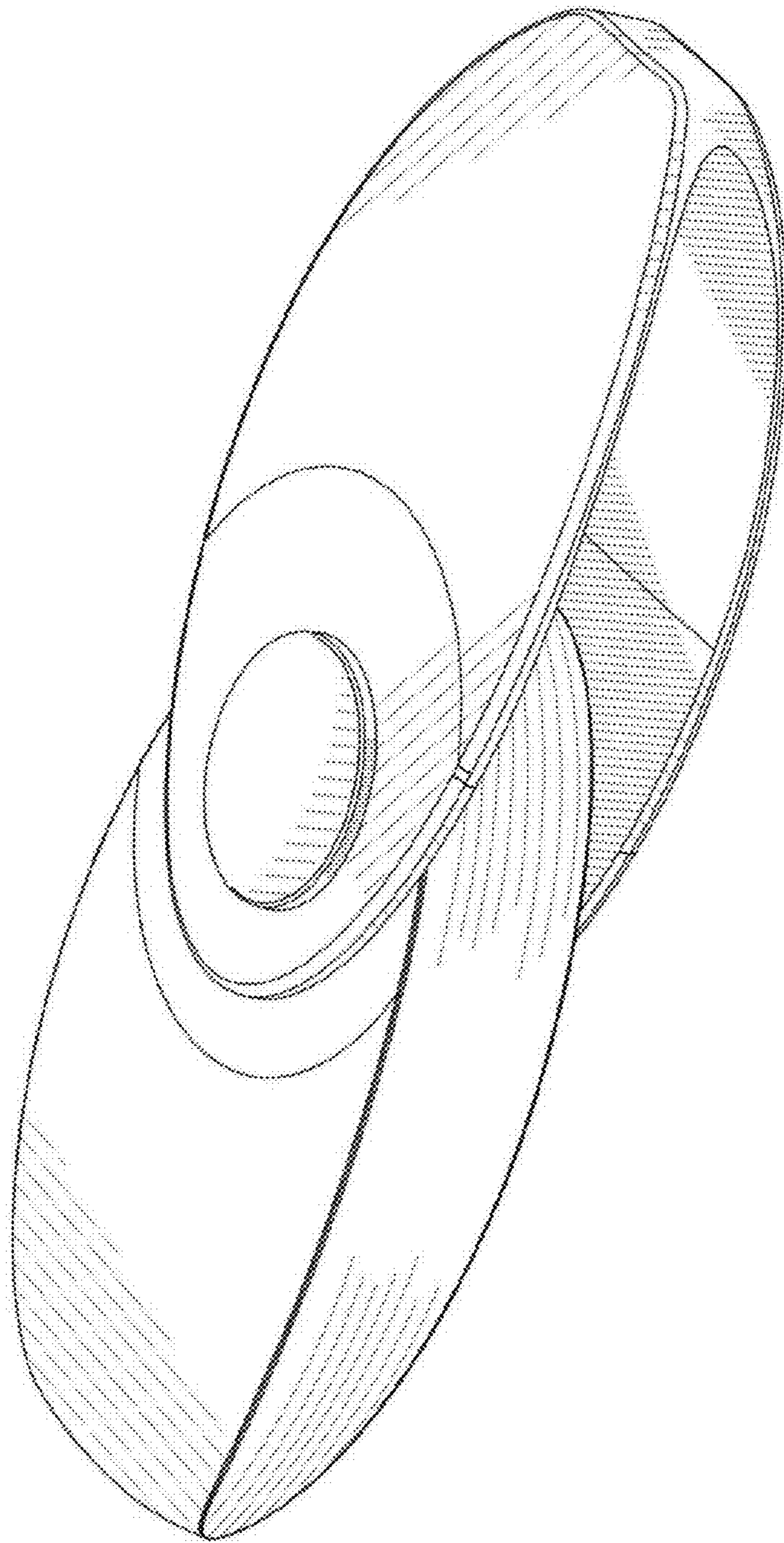

Fig. 2

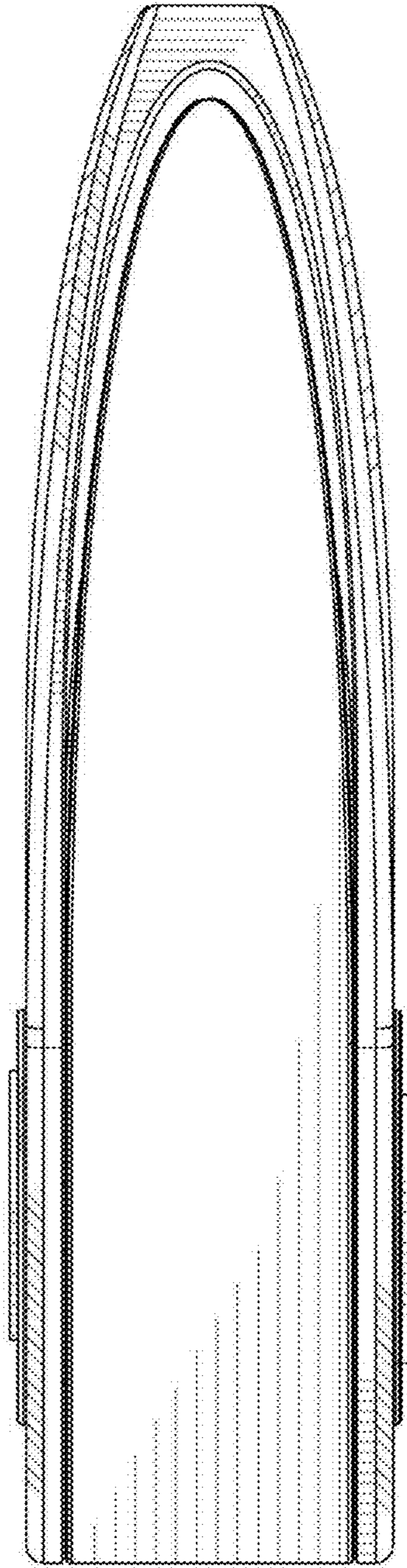

Fig. 3

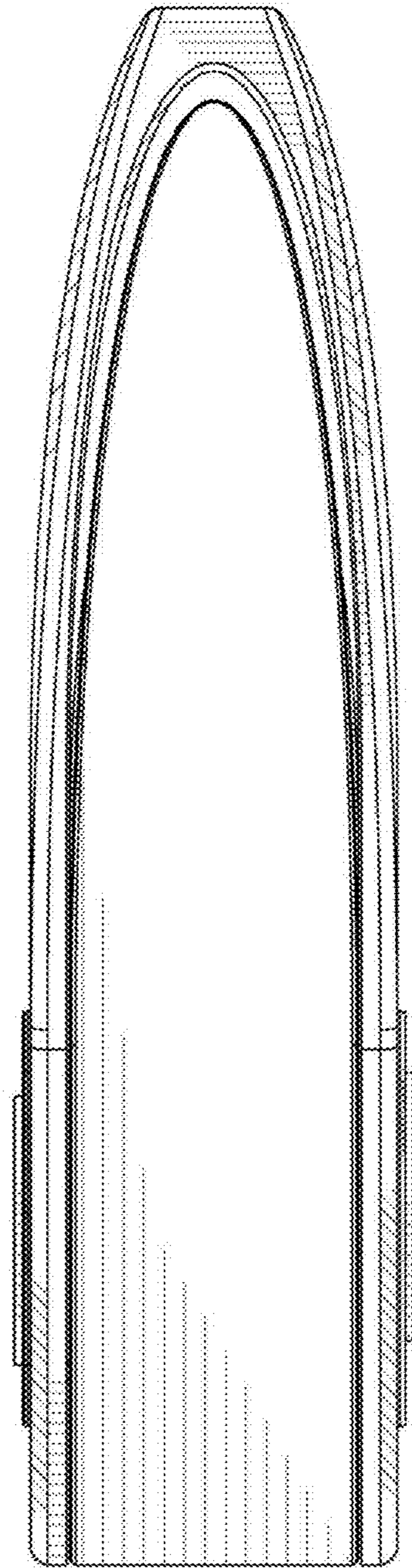

Fig. 4

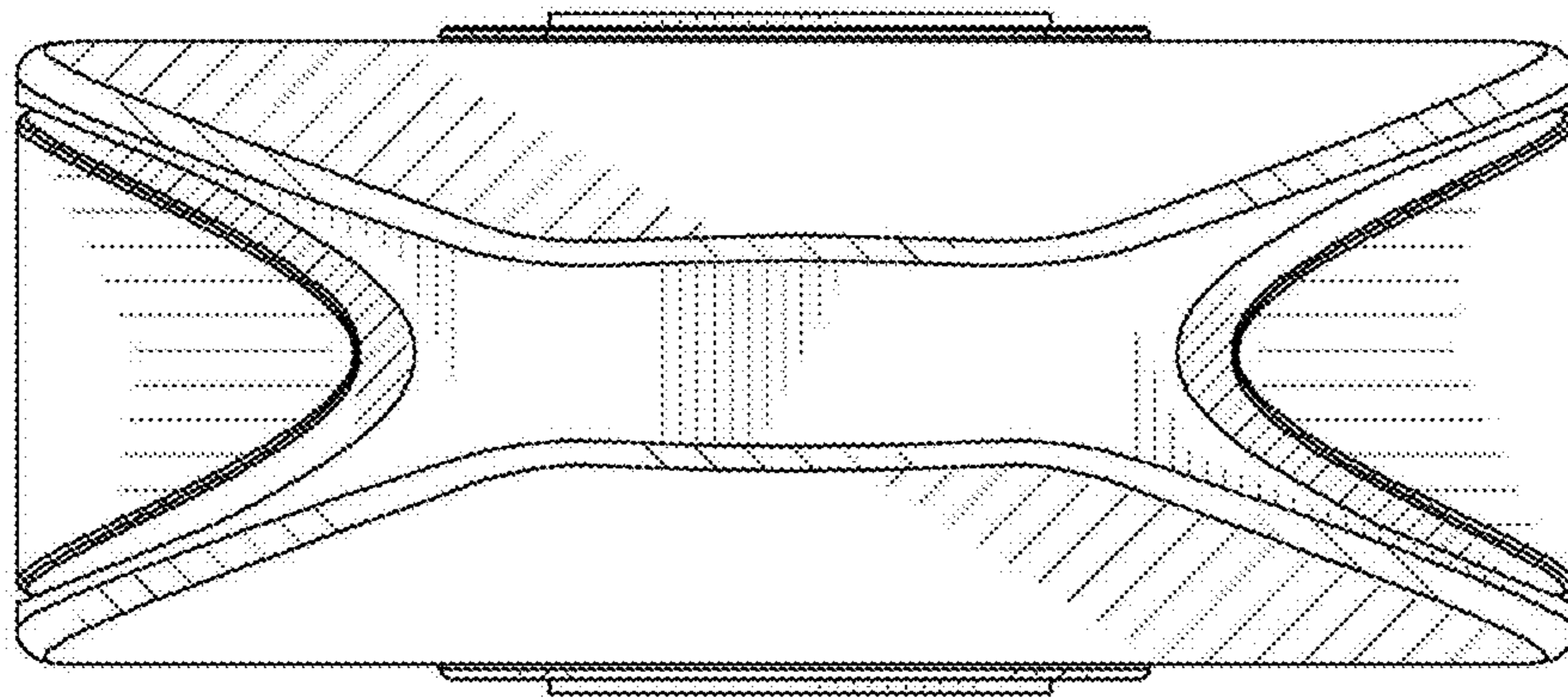

Fig. 5

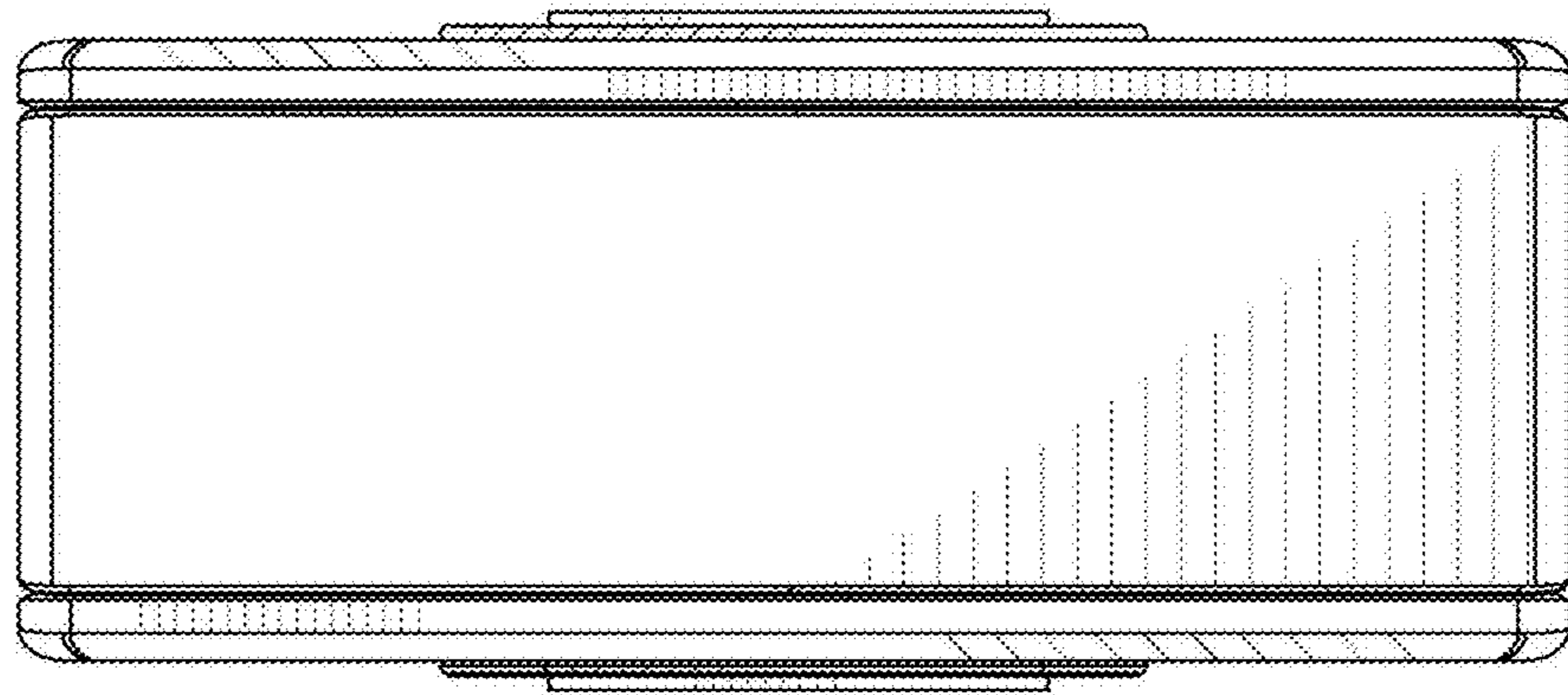

Fig. 6

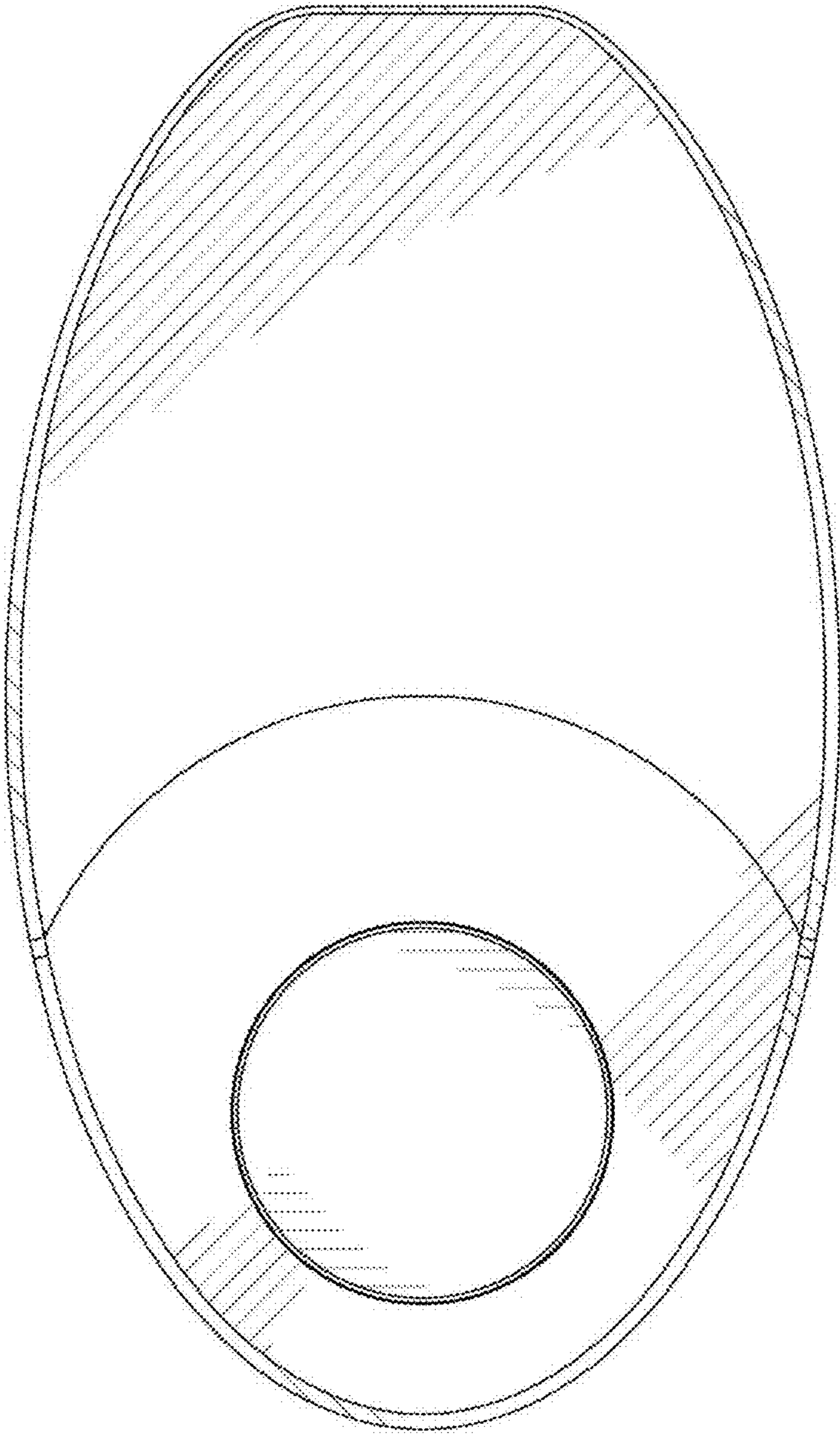

Fig. 7

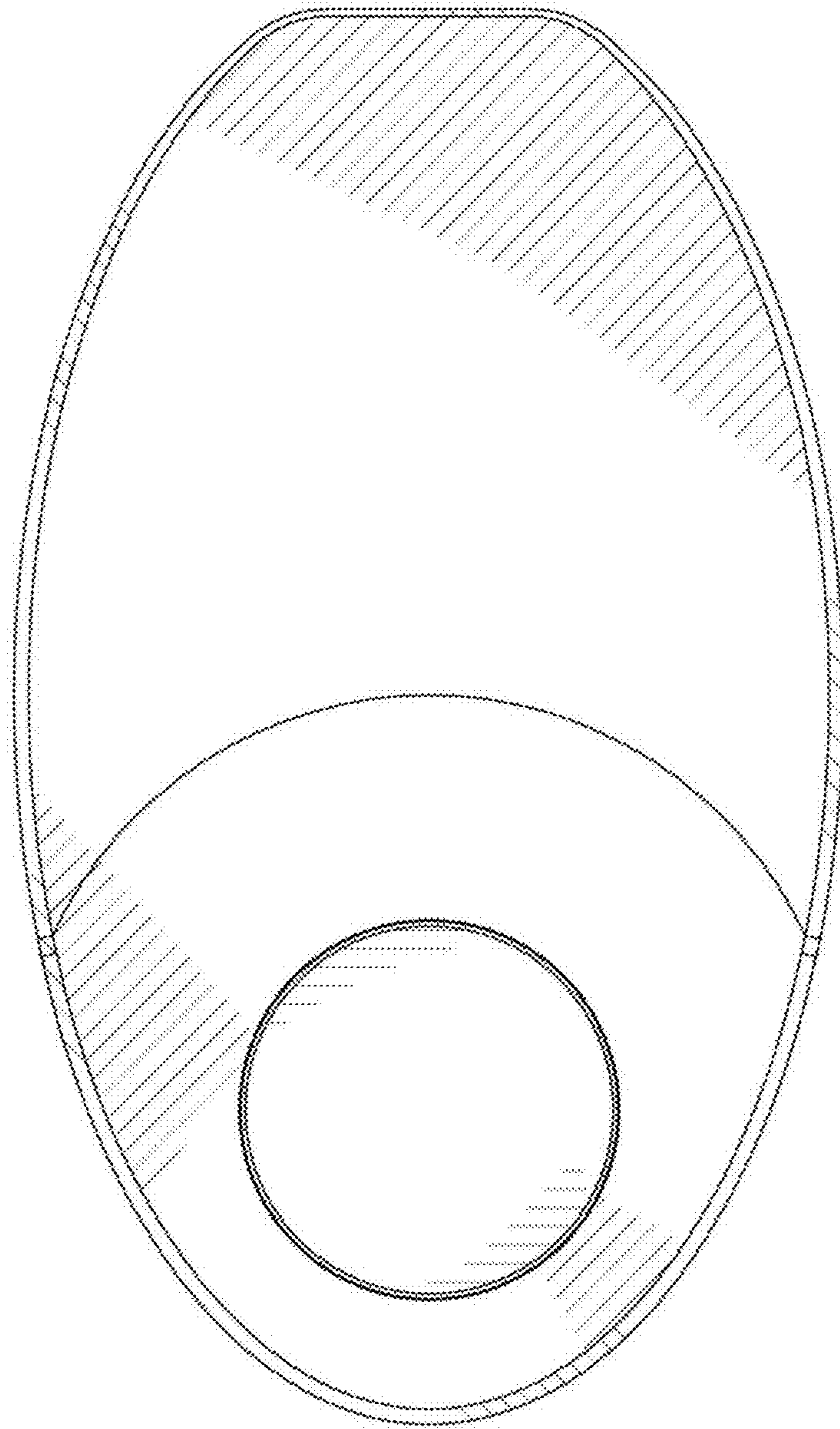

Fig. 8