



US00D768129S

(12) **United States Design Patent** (10) **Patent No.:** **US D768,129 S**
Chen (45) **Date of Patent:** **** Oct. 4, 2016**

(54) **STORAGE DEVICE**

- (71) Applicant: **Inxtron, Inc.**, New Taipei (TW)
- (72) Inventor: **Szu-Tien Chen**, New Taipei (TW)
- (73) Assignee: **Inxtron, Inc.**, New Taipei (TW)
- (**) Term: **14 Years**

- (21) Appl. No.: **29/517,521**
- (22) Filed: **Feb. 13, 2015**
- (51) **LOC (10) Cl.** **14-02**
- (52) **U.S. Cl.**
USPC **D14/356**; D14/349
- (58) **Field of Classification Search**
USPC D14/300, 348, 349, 353, 355, 356, 357,
D14/358, 363-370, 439; D13/162, 184,
D13/199; 312/223.1, 223.3; 360/99.12;
361/690-696
CPC G06F 1/1632; G06F 13/409; G06F
13/4081; G06F 21/32; G06F 21/602; G06F
21/6209; G06F 1/187; H04L 9/3231; H04L
9/085; H04L 9/0825; G11B 33/128; G11B
33/08; G11B 33/022
See application file for complete search history.

(56) **References Cited**

U.S. PATENT DOCUMENTS

D290,844 S *	7/1987	Shibuya	D14/365
D410,445 S *	6/1999	Lee	D14/365
D425,495 S *	5/2000	Chiodo	D14/356
D435,559 S *	12/2000	Tanaka	D14/444
D461,805 S *	8/2002	Tanaka	D14/356
D462,350 S *	9/2002	Tanaka	D14/356
D462,351 S *	9/2002	Tanaka	D14/356
D463,427 S *	9/2002	Sherry	D14/356
D463,428 S *	9/2002	Tanaka	D14/356
D463,429 S *	9/2002	Tanaka	D14/356
D563,994 S *	3/2008	Liu	D14/356
D577,719 S *	9/2008	Kobeli	D14/300
D584,728 S *	1/2009	Park	D14/355
D608,359 S *	1/2010	Yu	D14/364

(Continued)

OTHER PUBLICATIONS

Galaxy 3500MGB-Raid Pro Network Storage. newegg.com [online] 4 pages. Available to the public as early as 2009 (see reviews) [retrieved on Mar. 16, 2016]. Retrieved from Internet: <http://www.newegg.com/Product/Product.aspx?Item=N82E16822344001>.*

(Continued)

Primary Examiner — Susan Bennett Hattan
Assistant Examiner — Marie Fast Horse
(74) *Attorney, Agent, or Firm* — SmithAmundsen LLC; Stephen L. Farris; Kelly J. Smith

(57) **CLAIM**

The ornamental design for a storage device, as shown and described.

DESCRIPTION

FIG. 1 is a perspective view of the storage device showing my new design;
FIG. 2 is a front elevational view thereof;
FIG. 3 is a rear elevational view thereof;
FIG. 4 is a left side elevational view thereof;
FIG. 5 is a right side elevational view thereof;
FIG. 6 is a top plan view thereof;
FIG. 7 is a bottom plan view thereof;
FIG. 8 is another perspective view thereof;
FIG. 9 is a perspective view of the second embodiment of the storage device;
FIG. 10 is a front elevational view thereof;
FIG. 11 is a rear elevational view thereof;
FIG. 12 is a left side elevational view thereof;
FIG. 13 is a right side elevational view thereof;
FIG. 14 is a top plan view thereof;
FIG. 15 is a bottom plan view thereof; and,
FIG. 16 is another perspective view thereof.
The portions of the storage device shown in broken linestyle form no part of the claimed design.

1 Claim, 16 Drawing Sheets

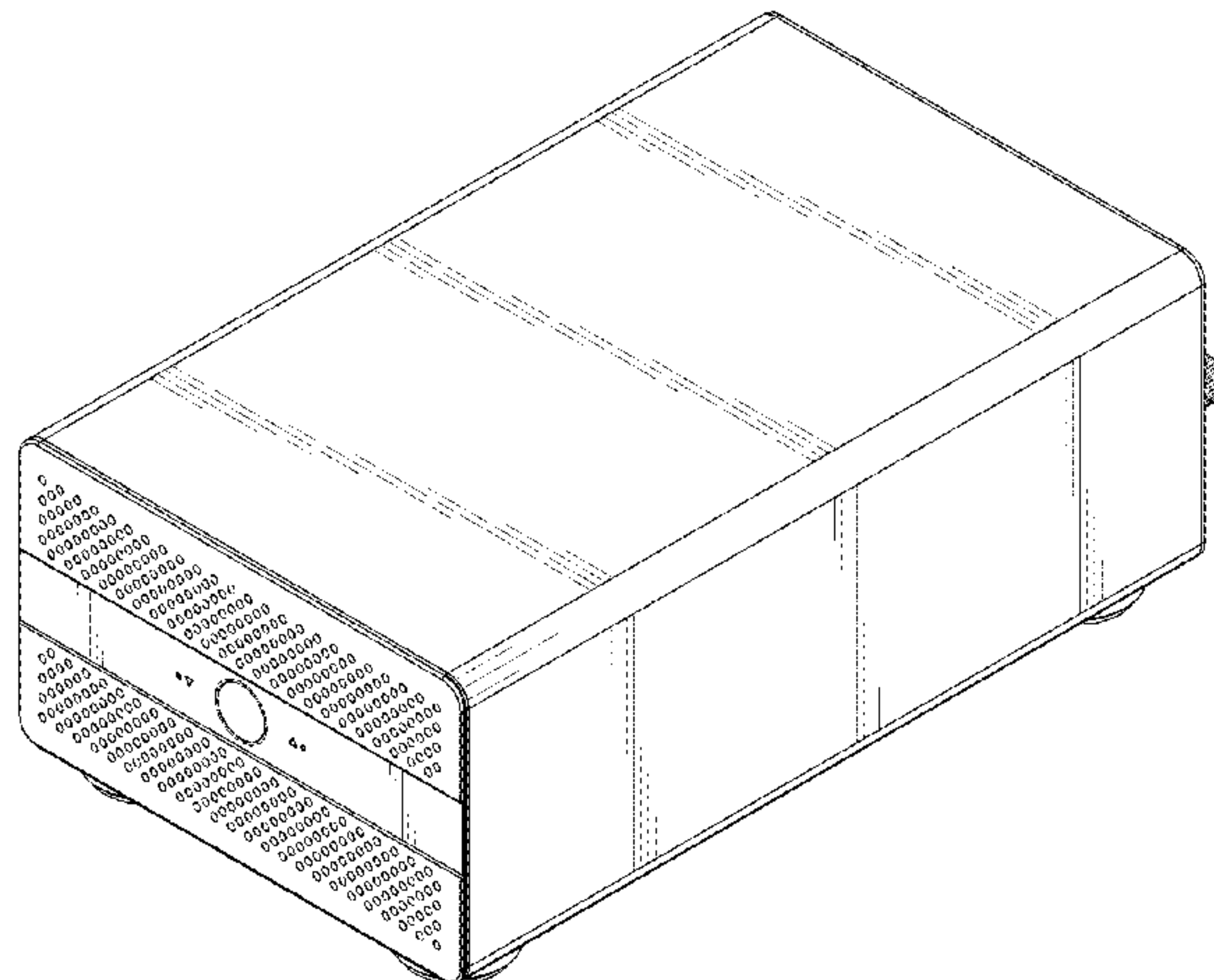

(56)

References Cited

U.S. PATENT DOCUMENTS

D649,541 S * 11/2011 Morenstein D14/314
D677,253 S * 3/2013 Crisp D14/300
D689,484 S * 9/2013 Kuo D14/358
D689,857 S * 9/2013 Amit D14/349
D693,336 S * 11/2013 Youens D14/300
D718,752 S * 12/2014 Wang D14/240
8,902,579 B1 * 12/2014 Lalouette G06F 1/187
361/679.33
D730,894 S * 6/2015 Hokari D14/364
D740,282 S * 10/2015 Peng D14/312

2002/0144044 A1* 10/2002 Moon G06F 3/0607
710/302
2012/0036322 A1* 2/2012 Klein G06F 1/187
711/114
2015/0114051 A1* 4/2015 Mao E05B 35/008
70/57

OTHER PUBLICATIONS

Dual-Drive Storage System. newegg.com [online] 3 pages. Available to the public as early as 2011 (see reviews) [retrieved on Mar. 16, 2016]. Retrieved from Internet: <<http://www.newegg.com/Product/Product.aspx?Item=N82E16822205071>>.*

* cited by examiner

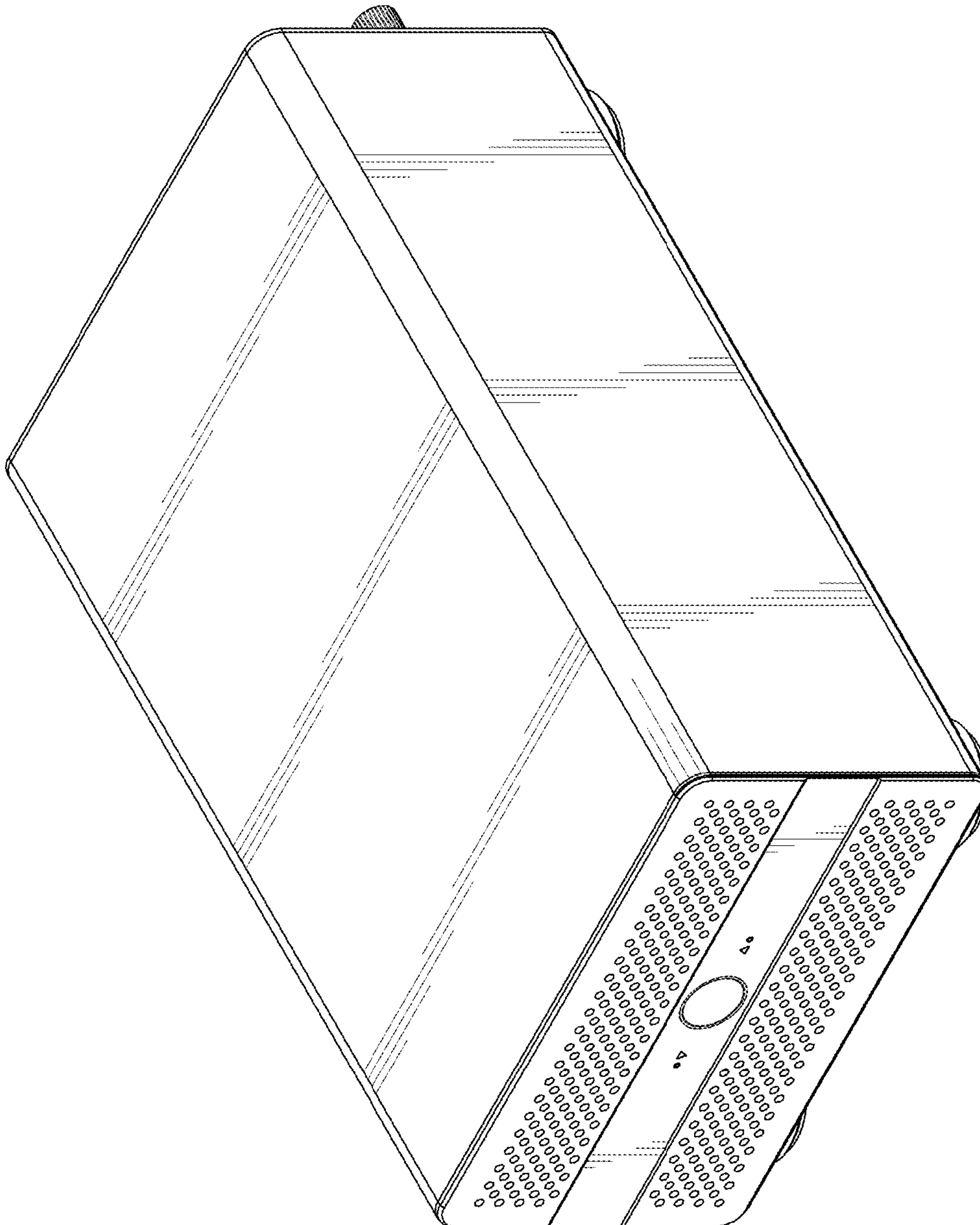

FIG.1

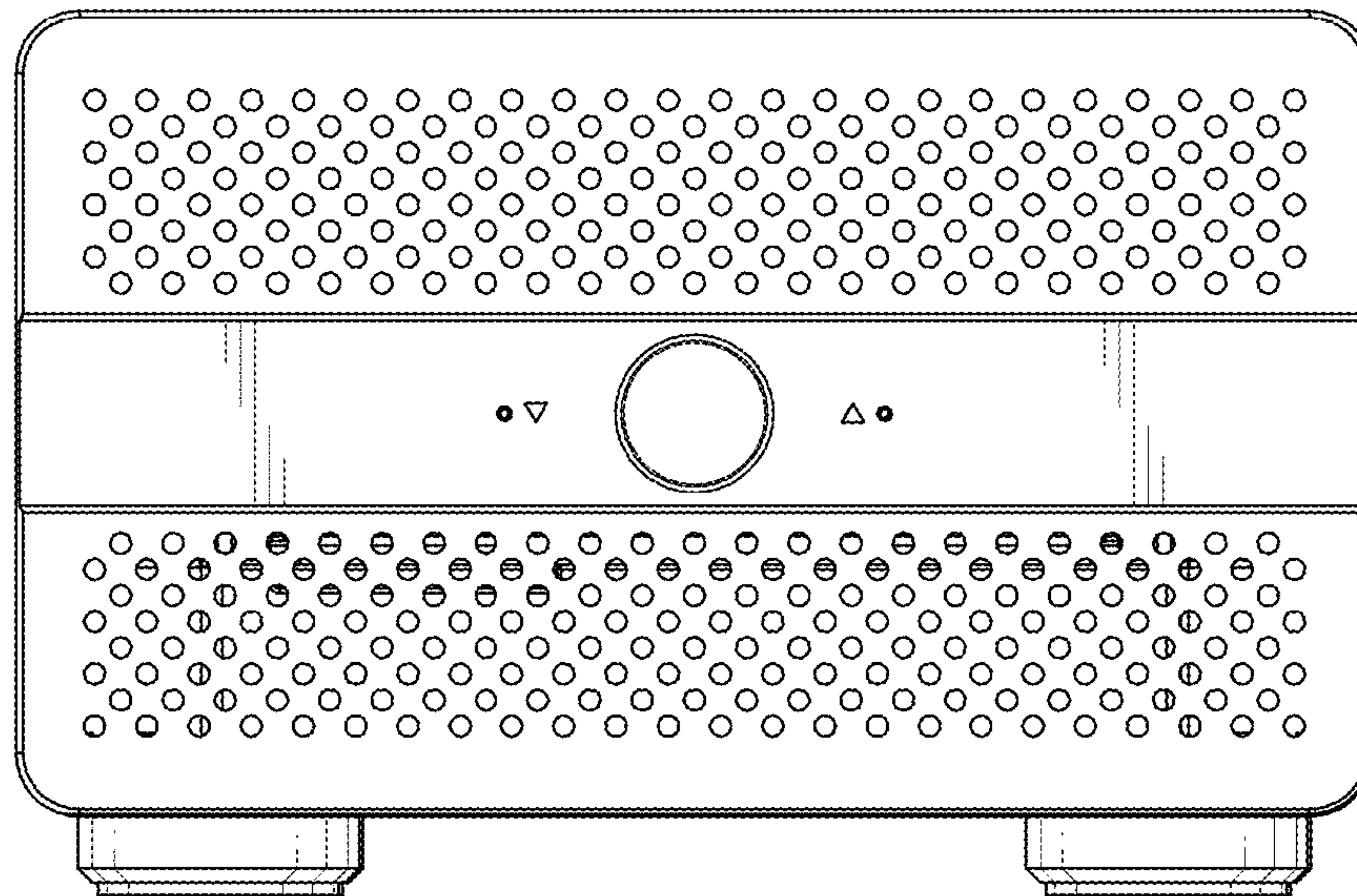

FIG.2

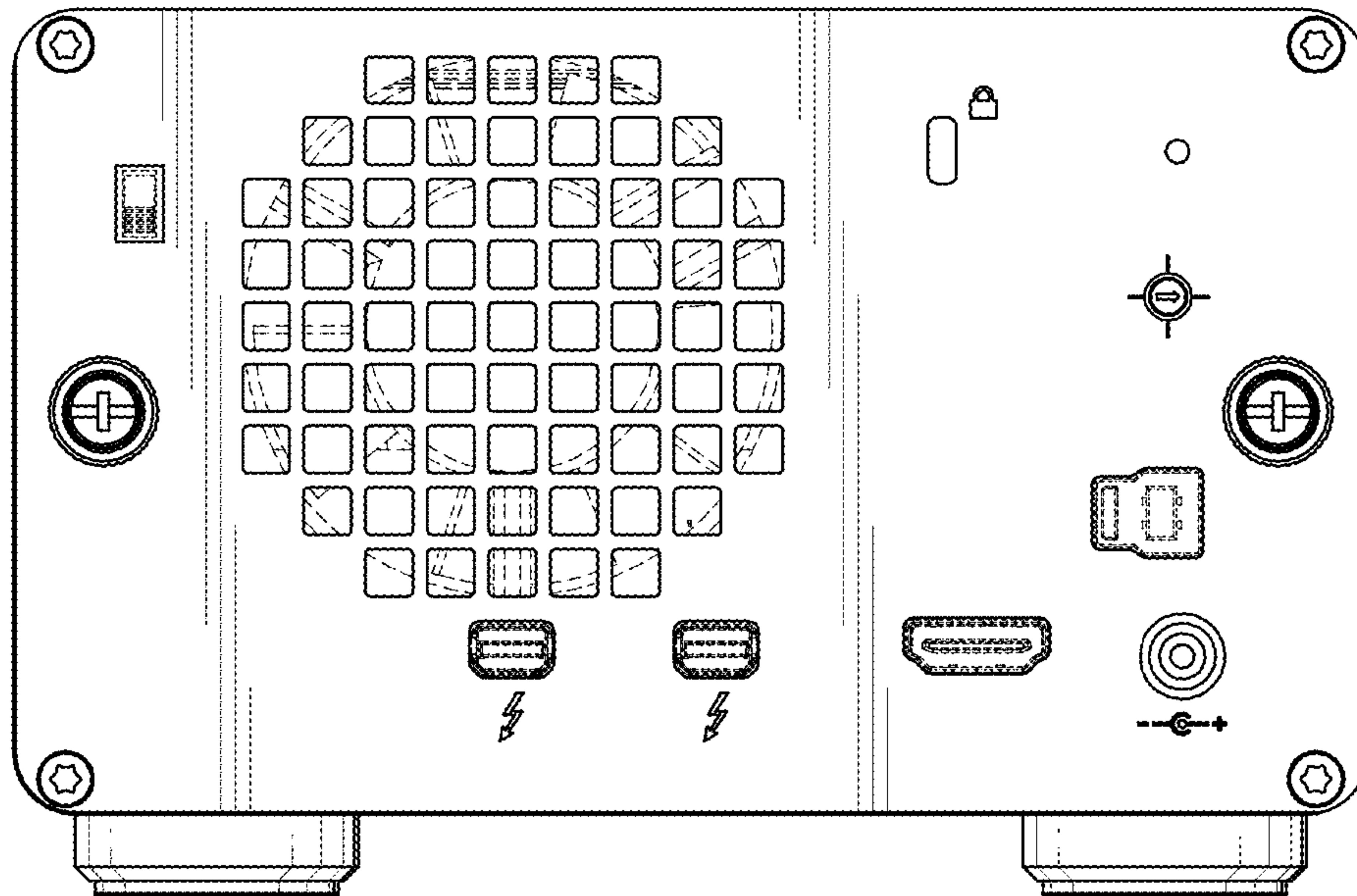

FIG.3

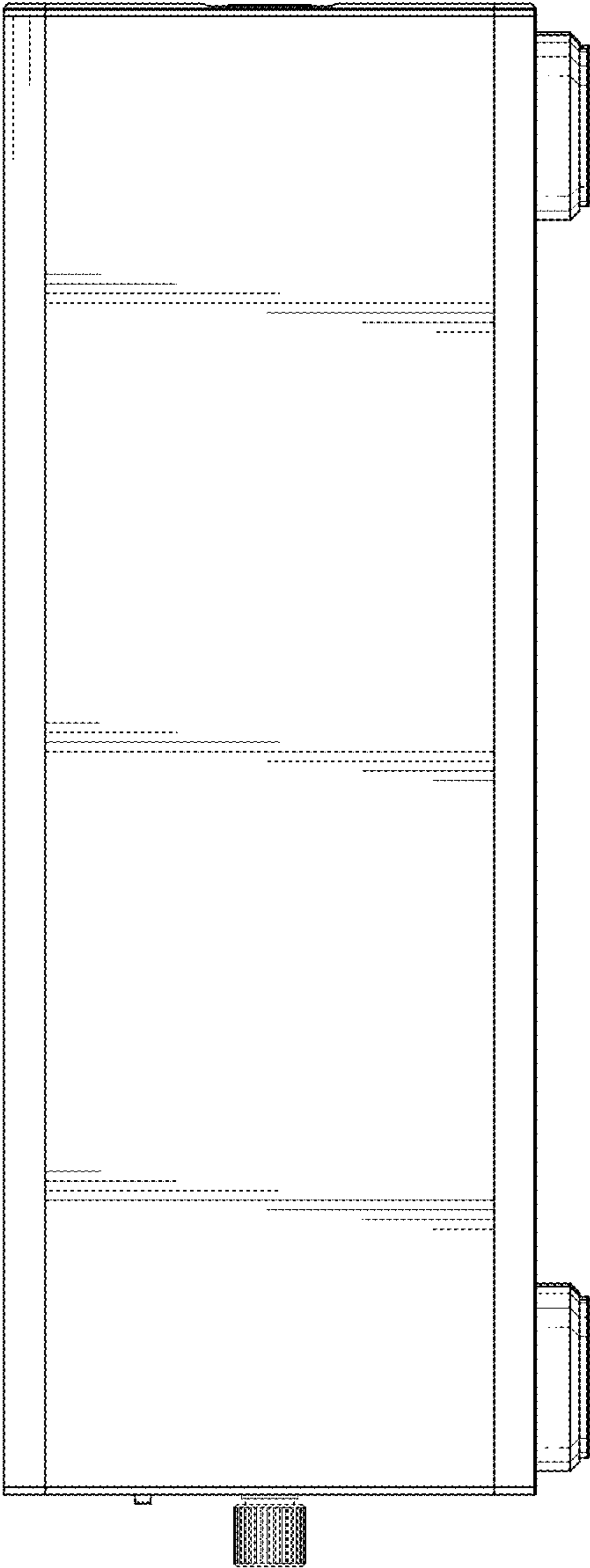

FIG.4

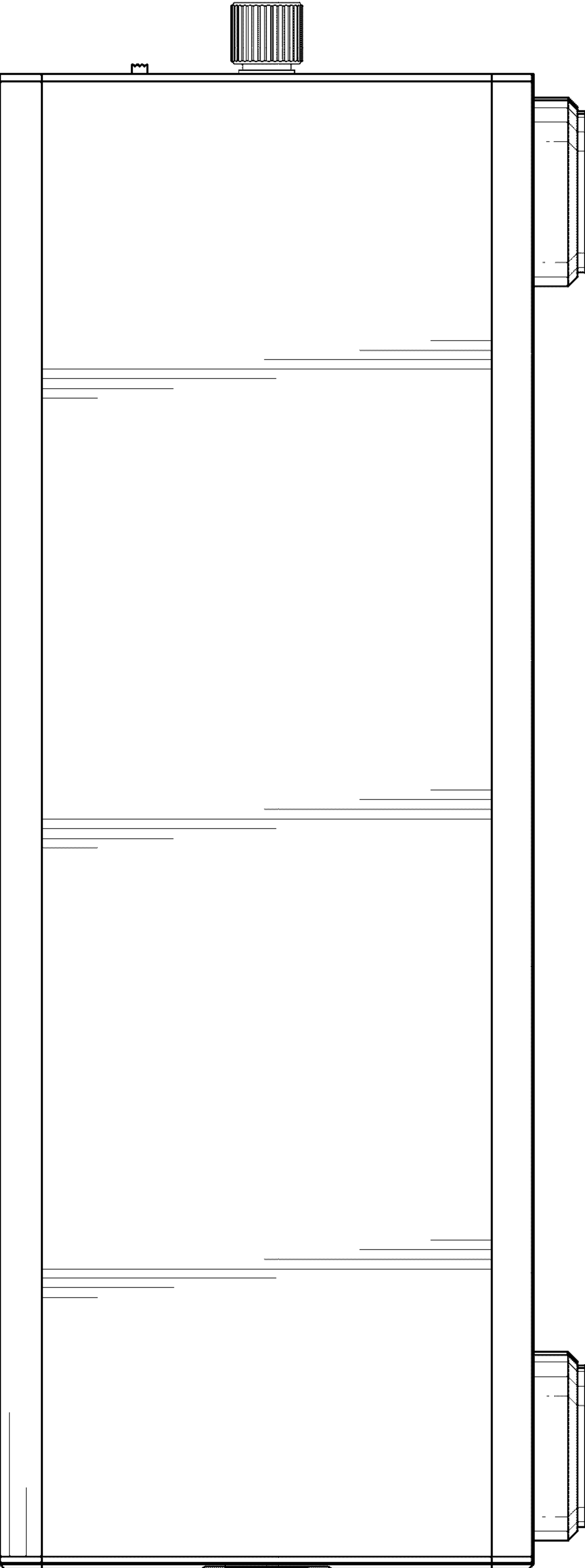

FIG. 5

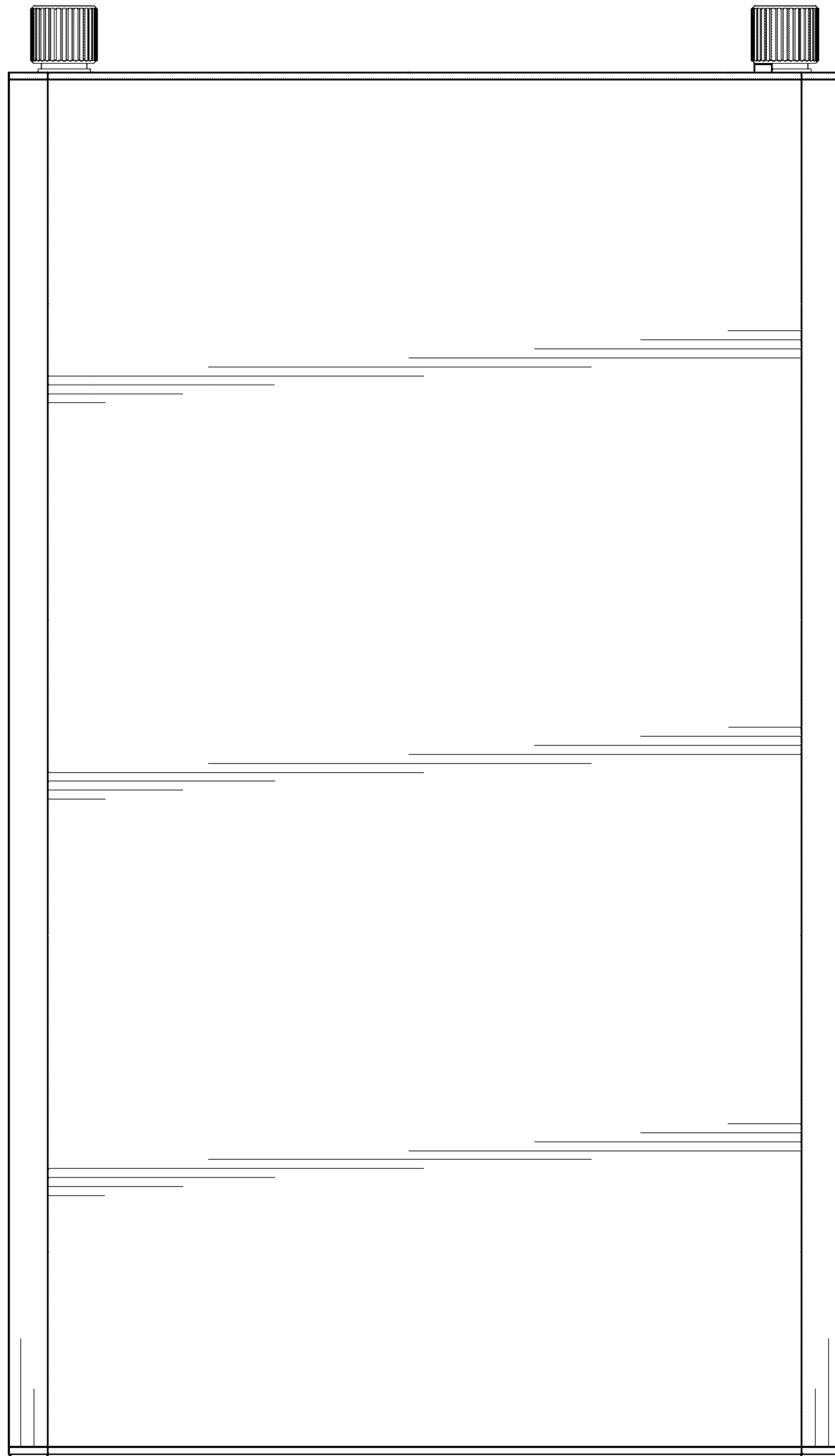

FIG.6

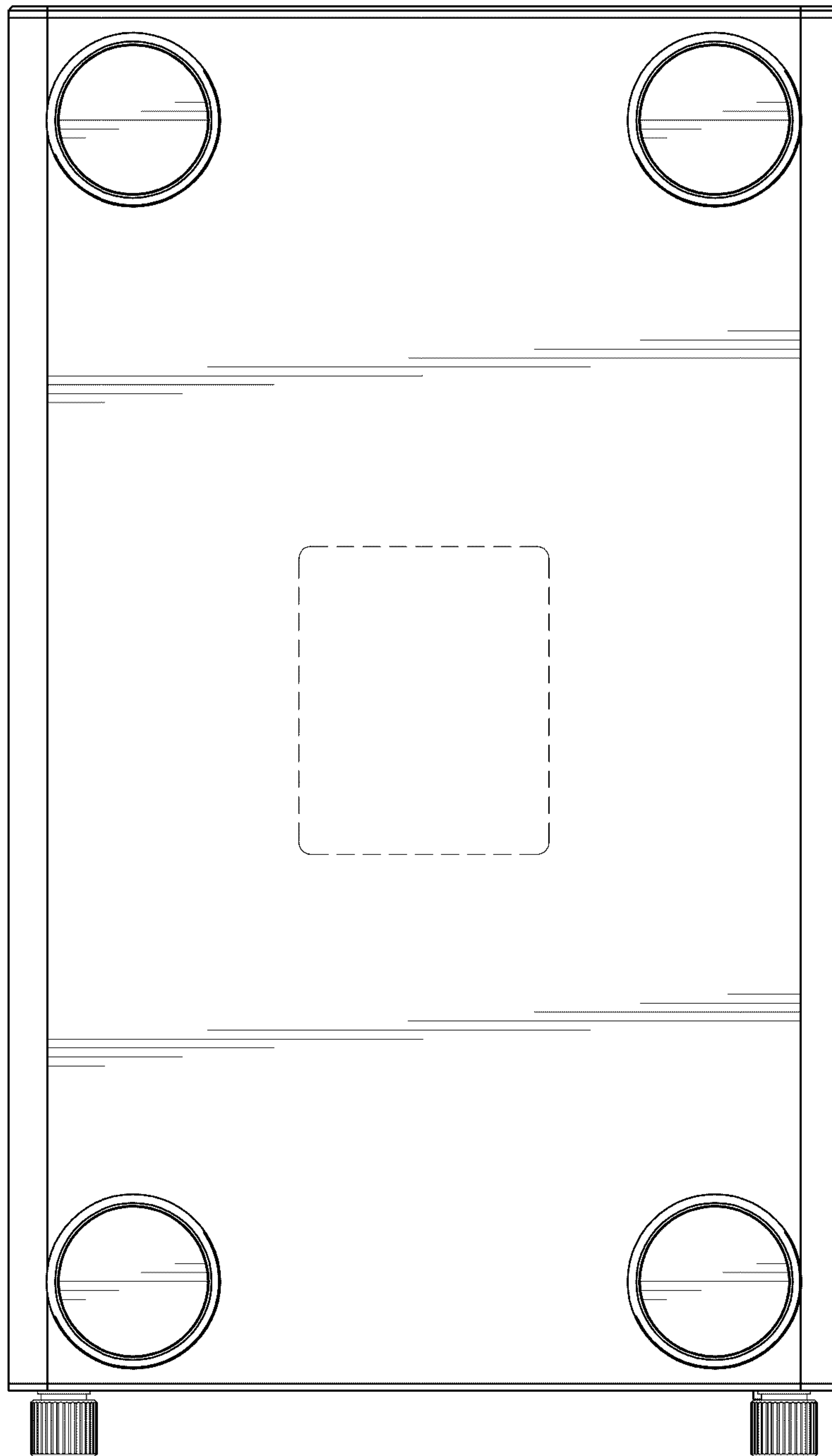

FIG.7

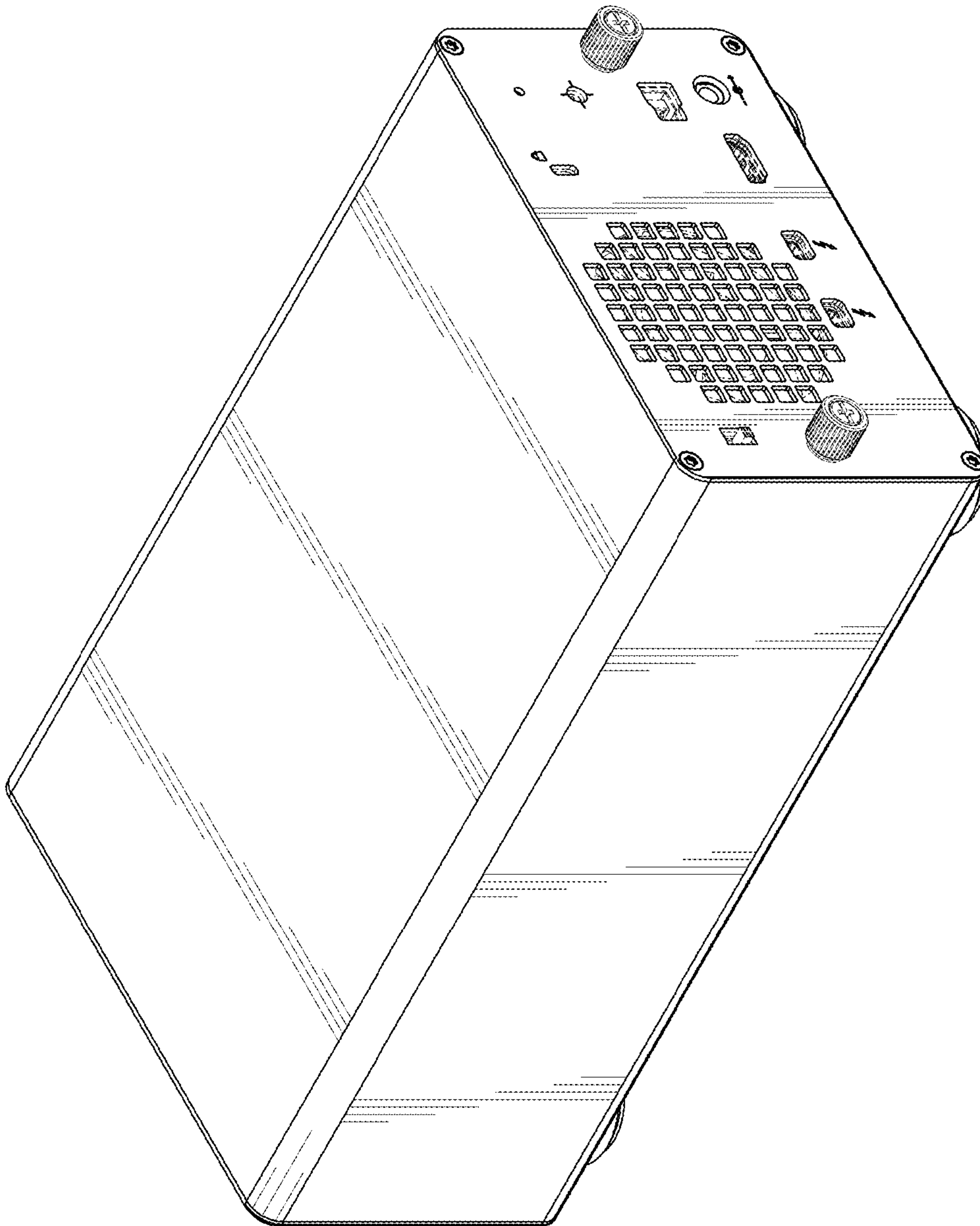

FIG. 8

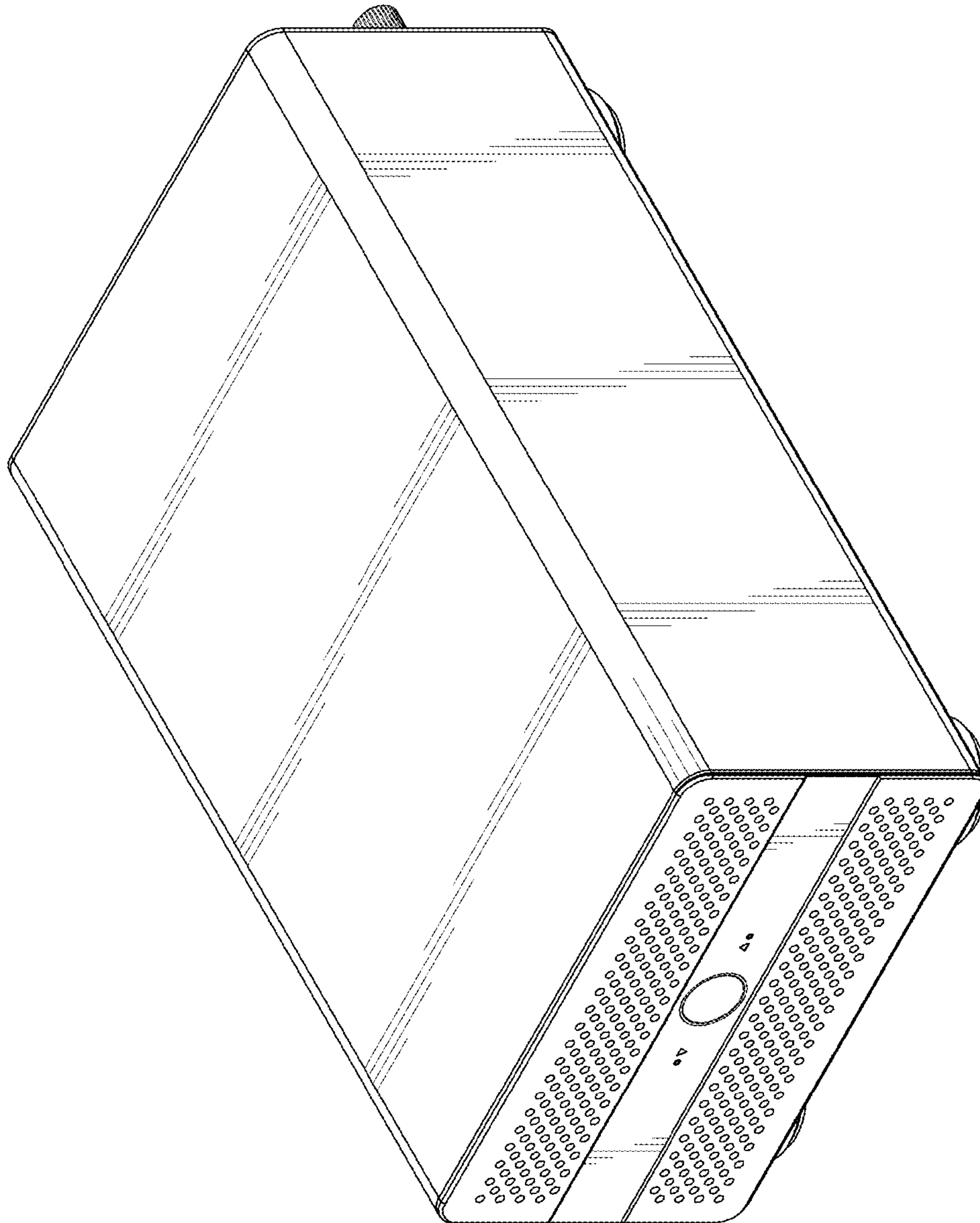

FIG. 9

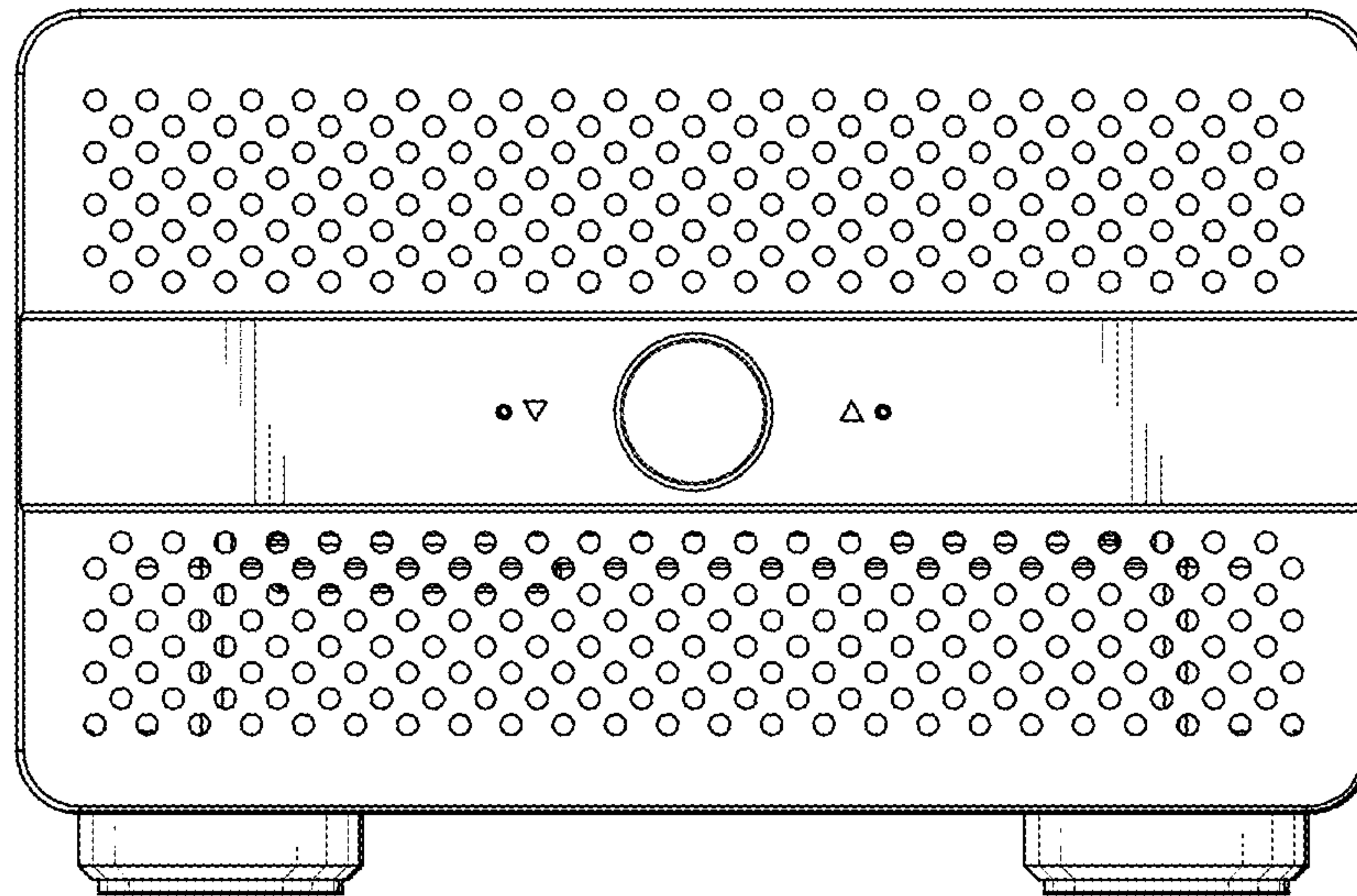

FIG.10

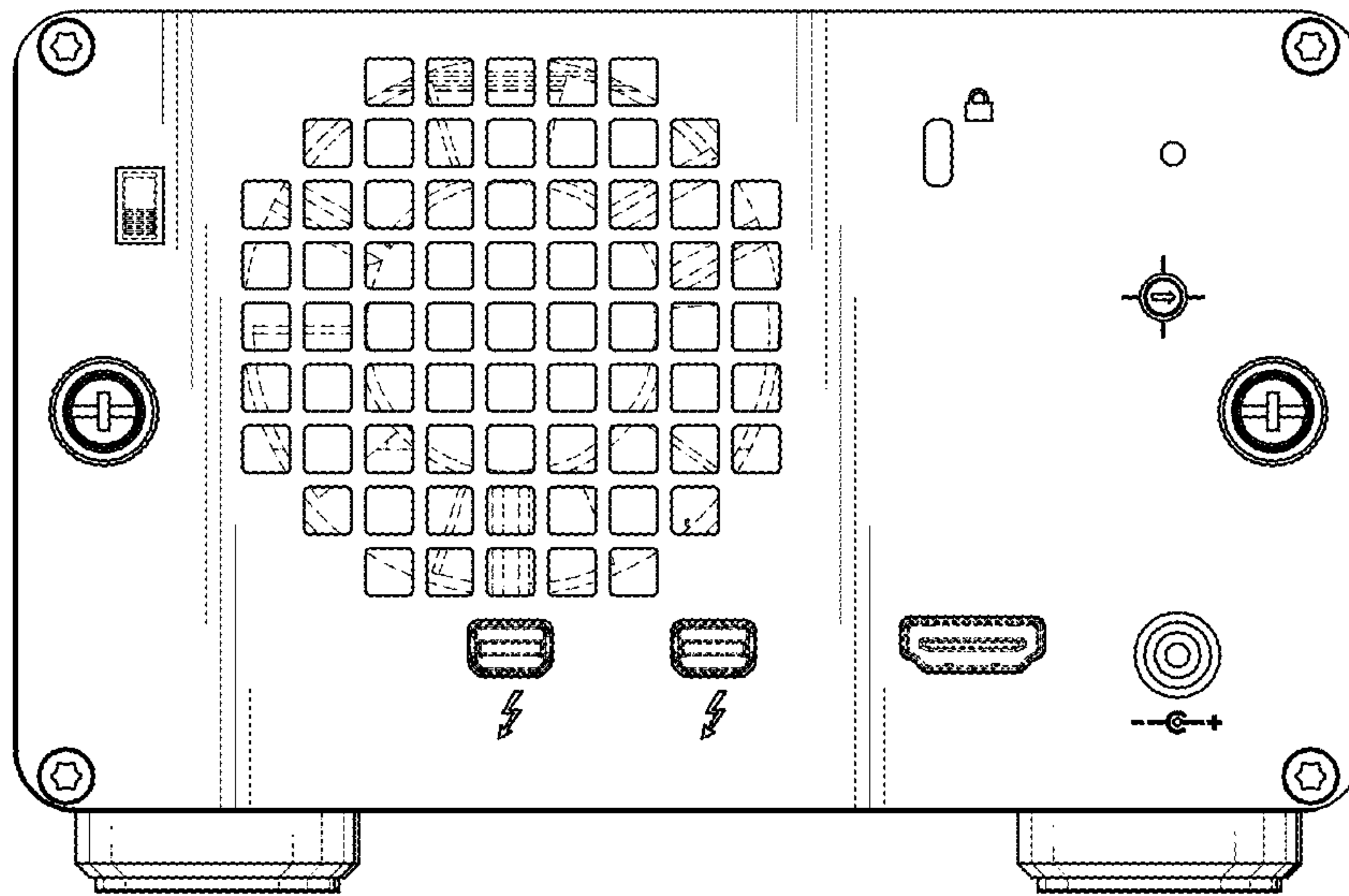

FIG.11

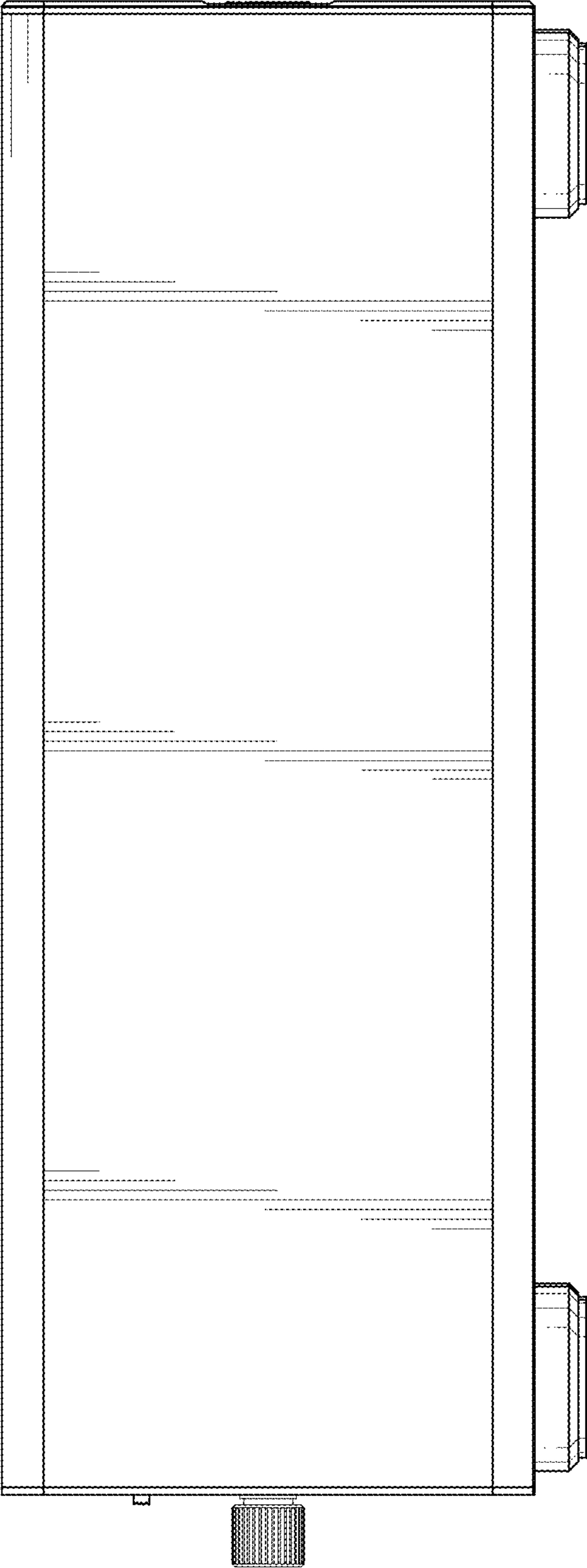

FIG.12

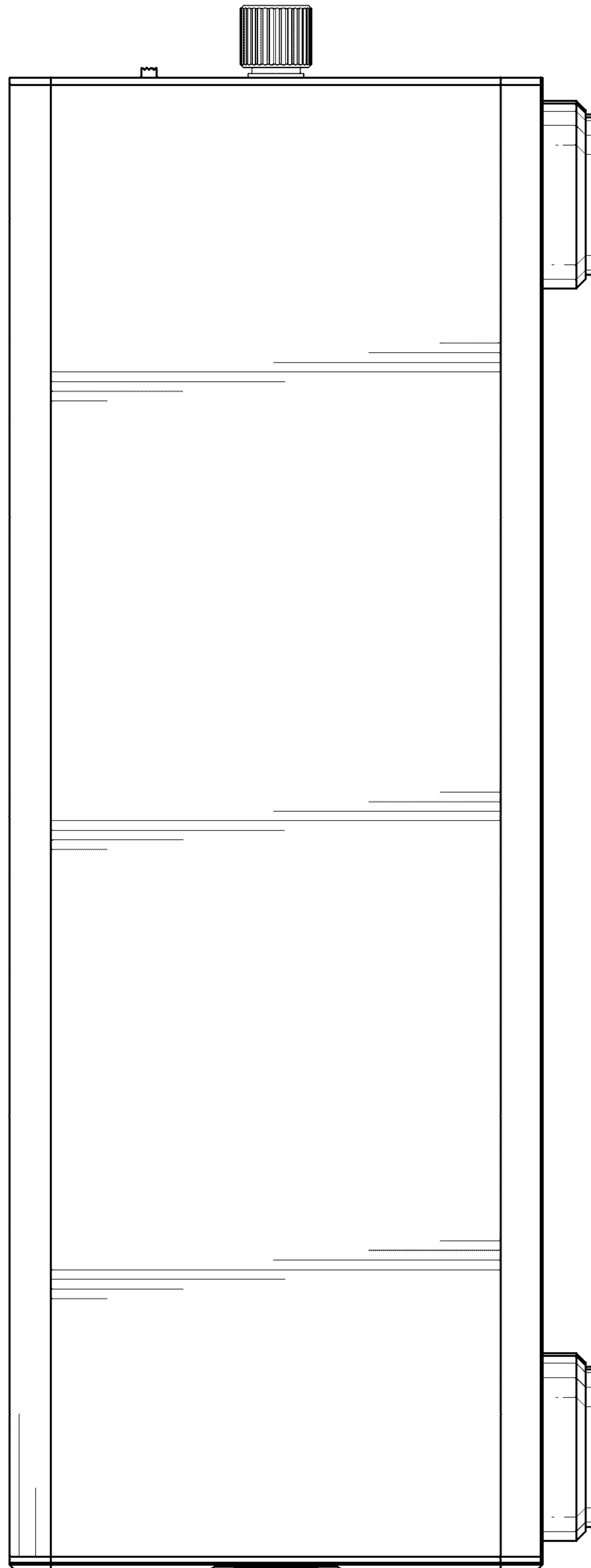

FIG.13

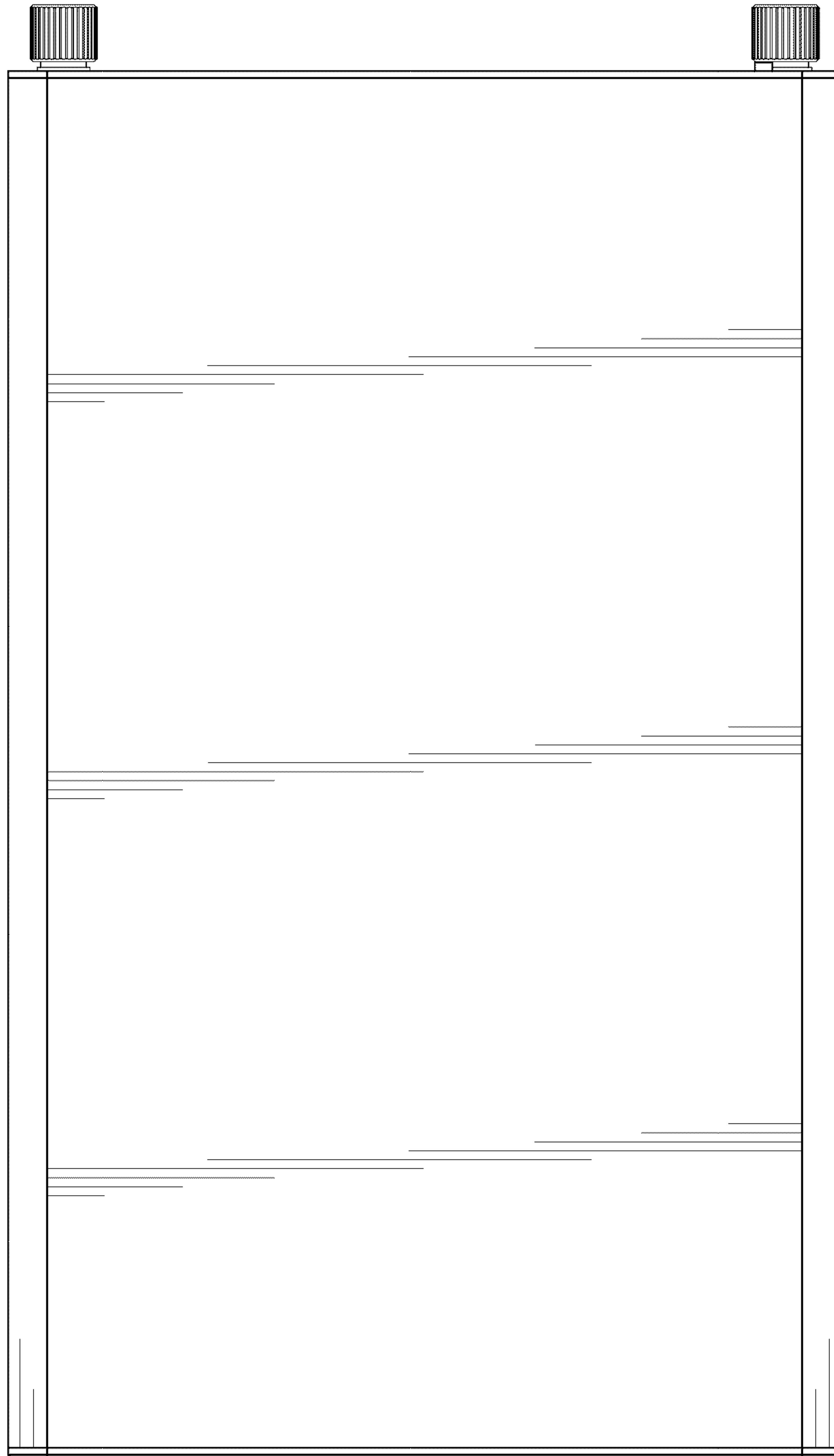

FIG.14

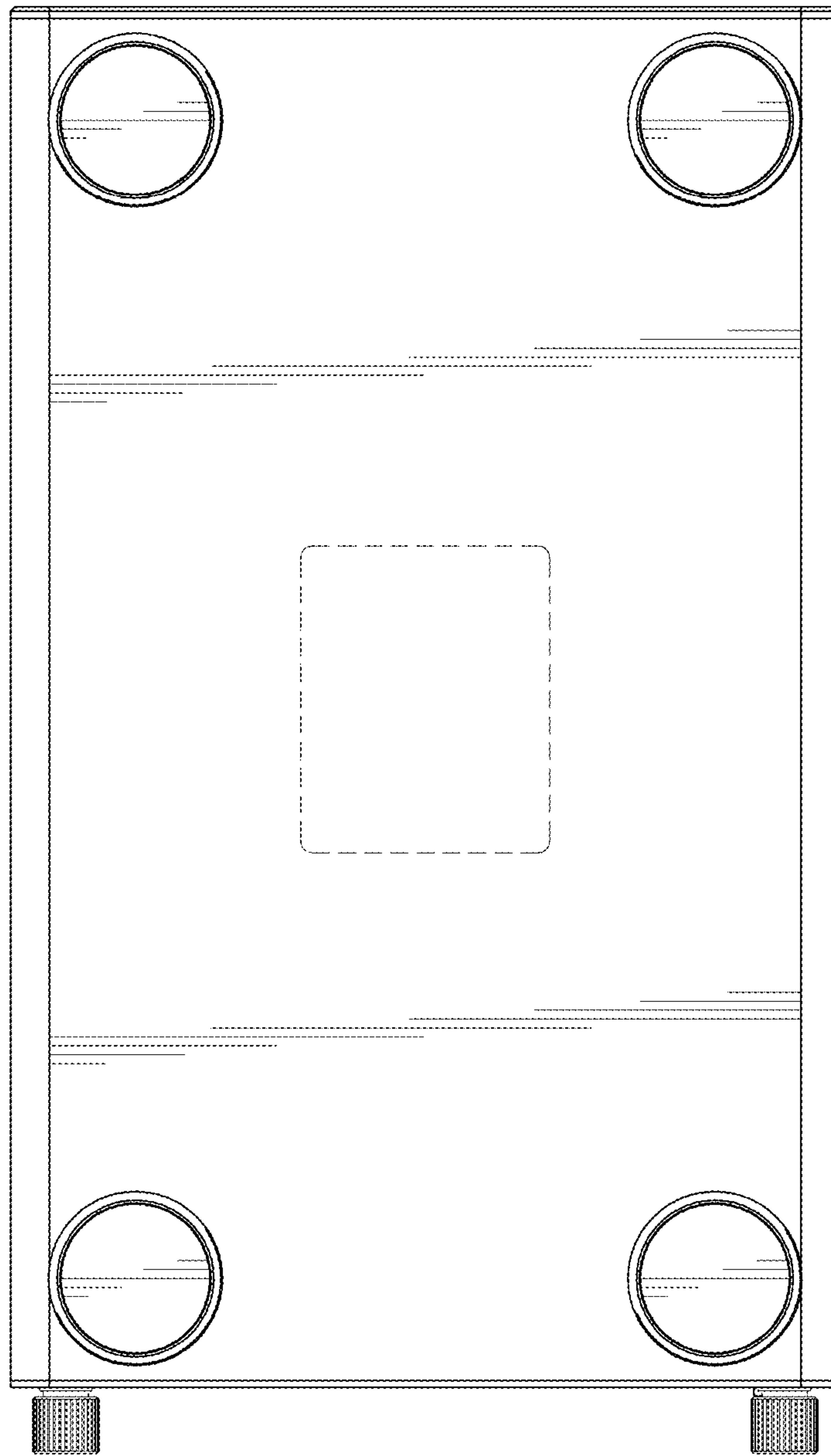

FIG.15

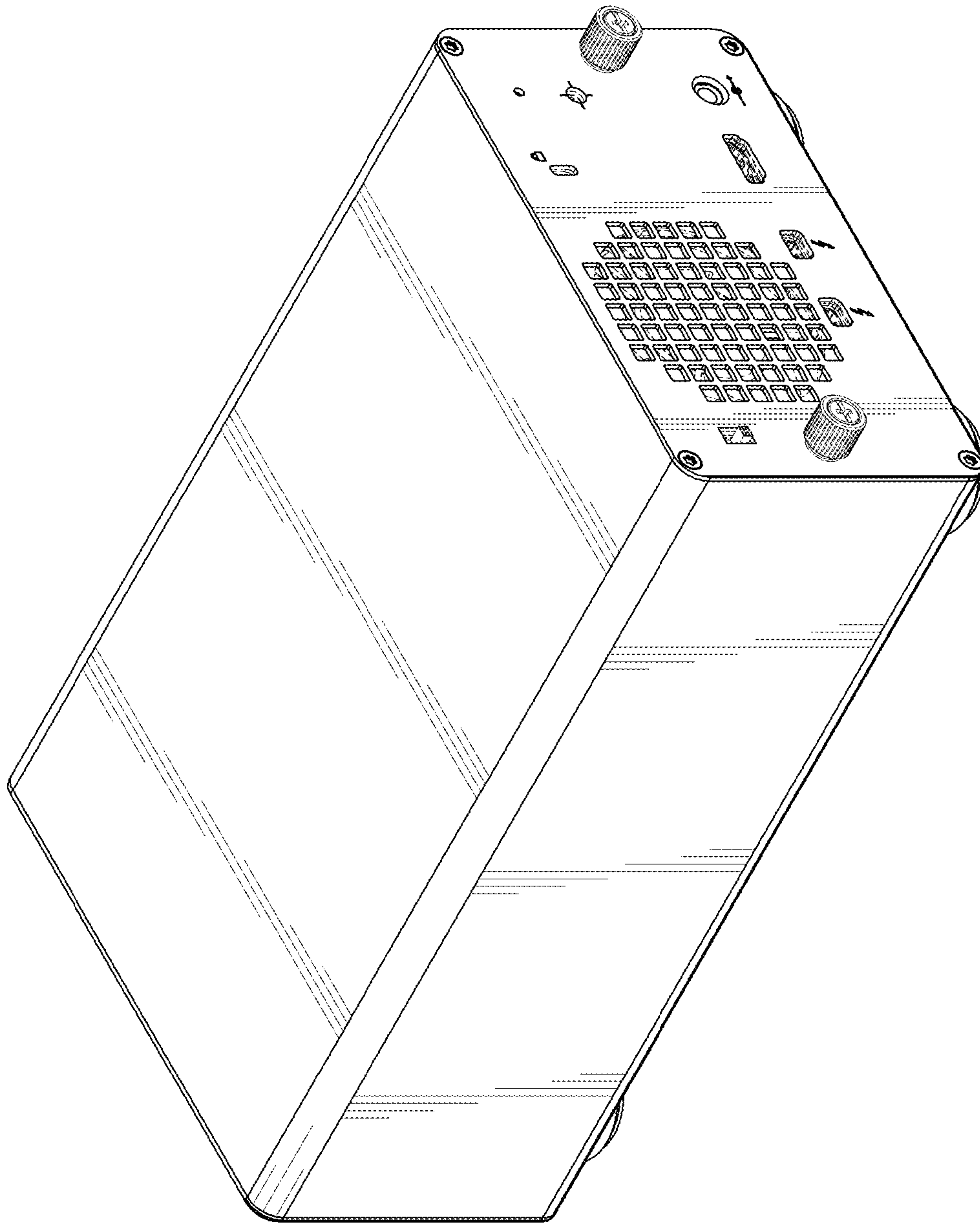

FIG.16