



US00D767959S

(12) **United States Design Patent**
Sokat et al.

(10) **Patent No.:** **US D767,959 S**
(45) **Date of Patent:** **** Oct. 4, 2016**

(54) **HAND-HELD POWER TOOL**

(71) Applicant: **Gustav Klauke GmbH**, Remscheid (DE)

(72) Inventors: **Jörg Sokat**, Wetter (DE); **Roman Bobowicz**, Remscheid (DE); **Egbert Frenken**, Heinsberg (DE); **Christoph Könnecke**, Frankfurt (DE)

(73) Assignee: **Gustav Klauke GmbH**, Remscheid (DE)

(**) Term: **14 Years**

(21) Appl. No.: **29/499,797**

(22) Filed: **Aug. 19, 2014**

(30) **Foreign Application Priority Data**

Feb. 21, 2014 (EM) 001403992

(51) **LOC (10) Cl.** **08-03**

(52) **U.S. Cl.**
USPC **D8/61**

(58) **Field of Classification Search**
USPC D8/61, 62, 67, 69; 81/57, 57.11, 57.14, 81/57.26, 429, 464, 469; 173/2, 170, 176, 173/181

CPC B25B 27/10; B25B 27/146; B25B 7/12; B25B 7/126; B25B 27/00; B25B 28/00; H01R 43/0428

See application file for complete search history.

(56) **References Cited**

U.S. PATENT DOCUMENTS

D388,300 S * 12/1997 Jeltsch D8/61
D405,233 S * 2/1999 Hirabayashi D8/61

D559,647 S * 1/2008 Watson D8/69
D593,828 S * 6/2009 Pond D8/61
D639,628 S * 6/2011 Zhou D8/61

(Continued)

Primary Examiner — Austin Murphy

(74) *Attorney, Agent, or Firm* — Klintworth and Rozenblat IP LLC

(57) **CLAIM**

The ornamental design for a hand-held power tool, as shown and described.

DESCRIPTION

FIG. 1 is a left side elevation view of the tool in accordance with a first embodiment;

FIG. 2 is a rear elevation view of the tool of FIG. 1;

FIG. 3 is a right side elevation view of the tool of FIG. 1;

FIG. 4 is a front elevation view of the tool of FIG. 1;

FIG. 5 is a top plan view of the tool of FIG. 1;

FIG. 6 is a bottom plan view of the tool of FIG. 1;

FIG. 7 is a perspective view of the tool of FIG. 1;

FIG. 8 is a left side elevation view of the tool in accordance with a second embodiment;

FIG. 9 is a rear elevation view of the tool of FIG. 8;

FIG. 10 is a right side elevation view of the tool of FIG. 8;

FIG. 11 is a front elevation view of the tool of FIG. 8;

FIG. 12 is a top plan view of the tool of FIG. 8;

FIG. 13 is a bottom plan view of the tool of FIG. 8; and,

FIG. 14 is a perspective view of the tool of FIG. 8.

The elements shown in broken line in the drawings is for the purpose of showing environmental structure and forms no part of the claimed design.

1 Claim, 12 Drawing Sheets

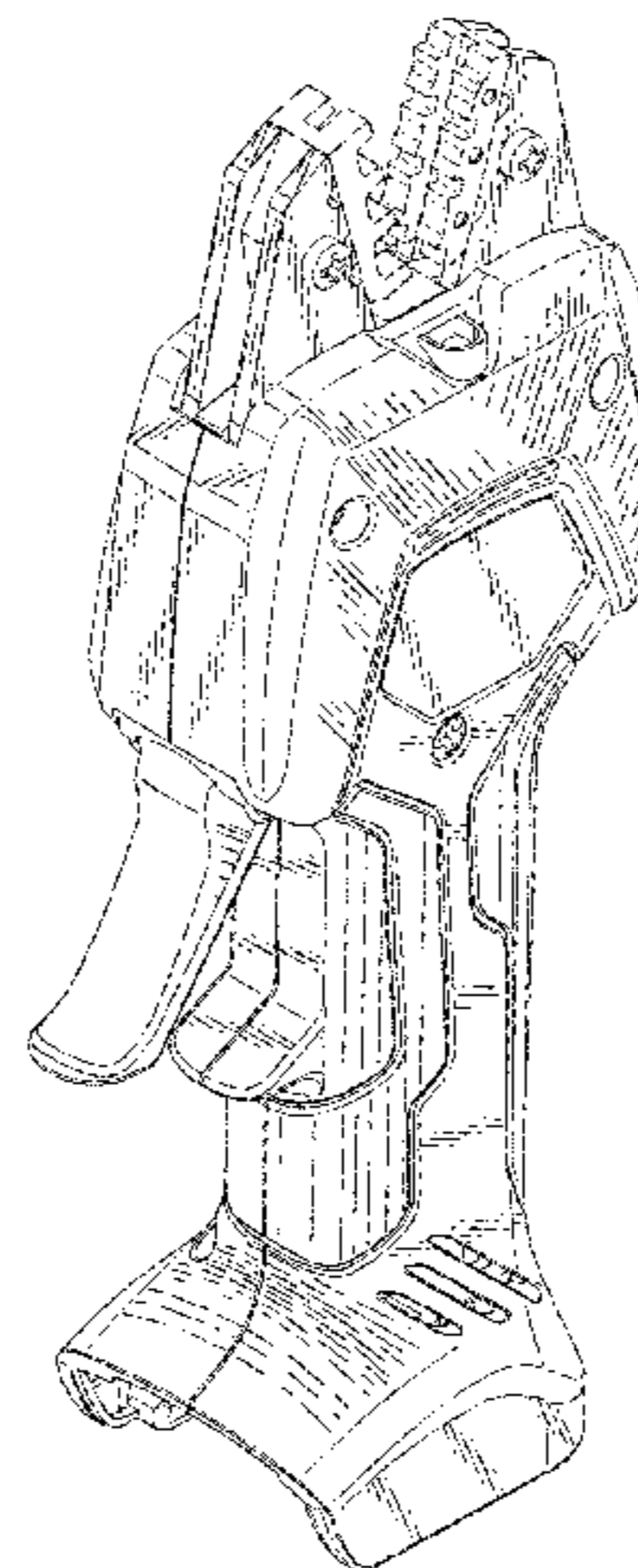
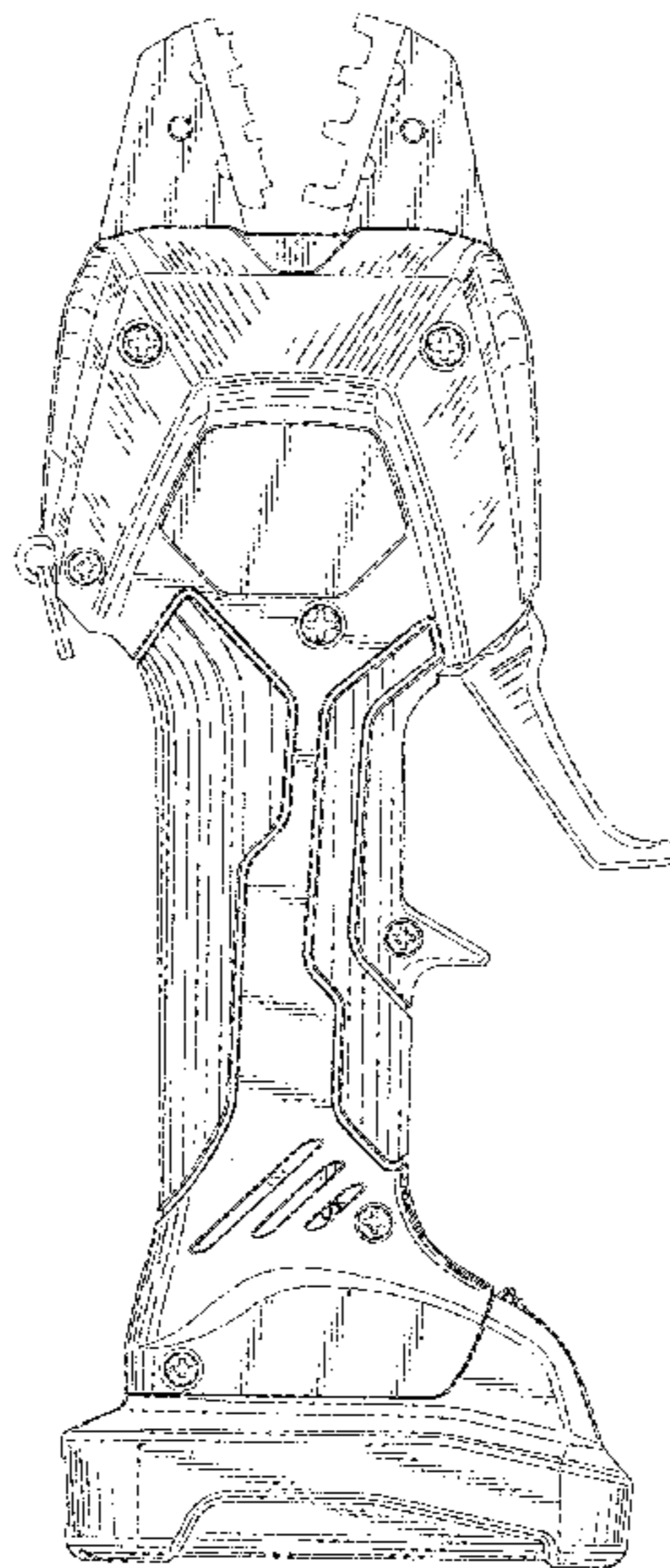

(56)

References Cited

U.S. PATENT DOCUMENTS

D657,220 S *	4/2012	Isobe	D8/61	D710,173 S *	8/2014	Frenken	D8/61
D668,922 S *	10/2012	Hyma	D8/61	D716,124 S *	10/2014	Kamijyo	D8/61
D673,829 S *	1/2013	Takehima	D8/61	D734,112 S *	7/2015	Herault	D8/61
D696,090 S *	12/2013	Takehima	D8/61	2010/0139100 A1 *	6/2010	Mortensen	B26B 17/02 30/92
D709,748 S *	7/2014	Frenken	D8/61	2010/0325894 A1 *	12/2010	Scott	B23D 21/00 30/92

* cited by examiner

Fig. 1

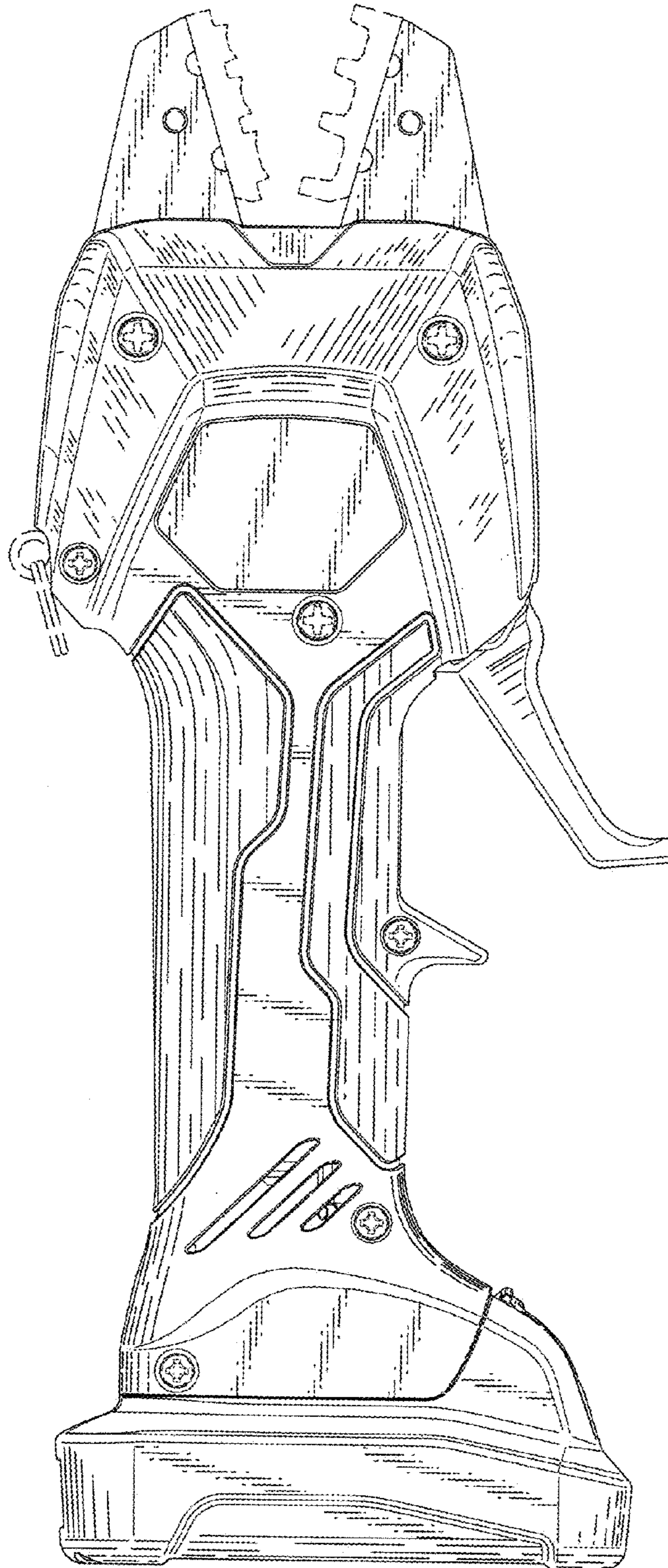

Fig. 2

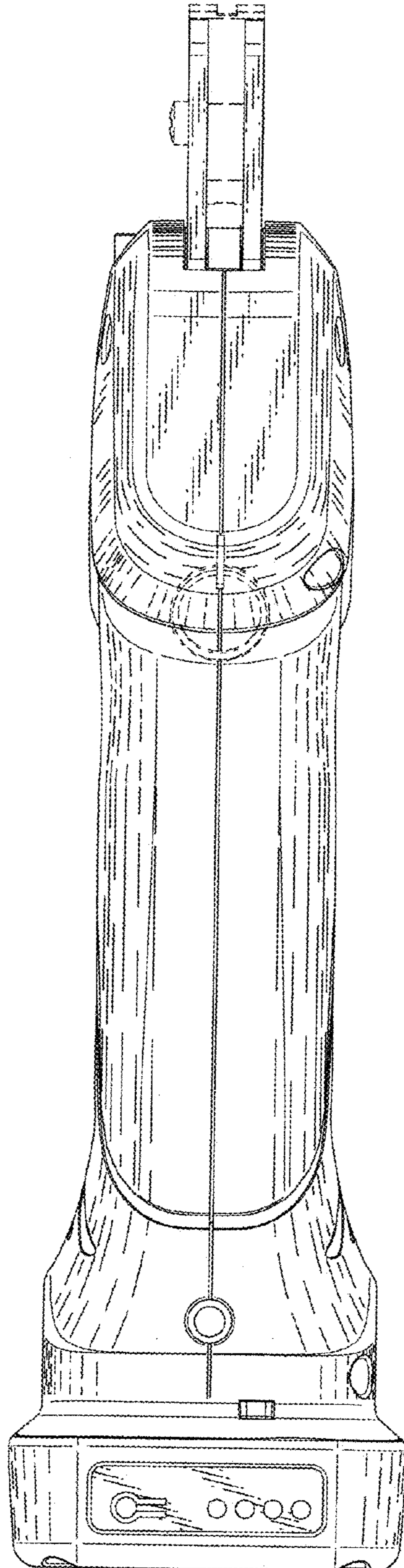

Fig. 3

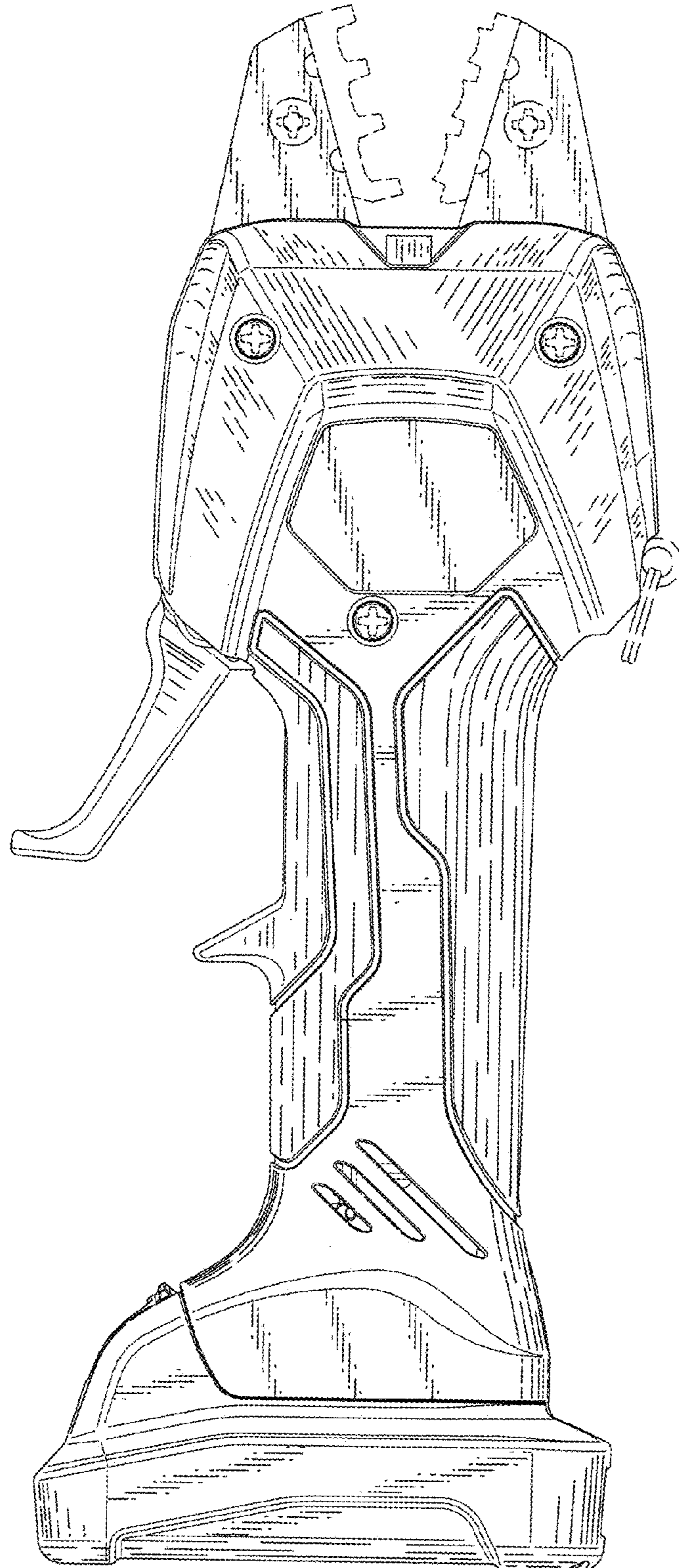

Fig. 4

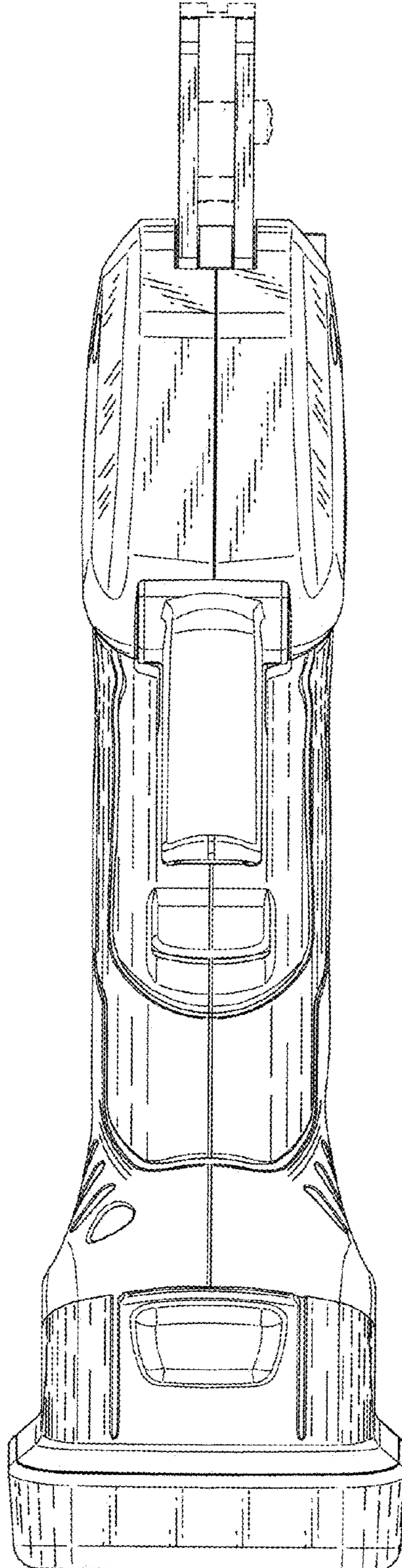

Fig. 5

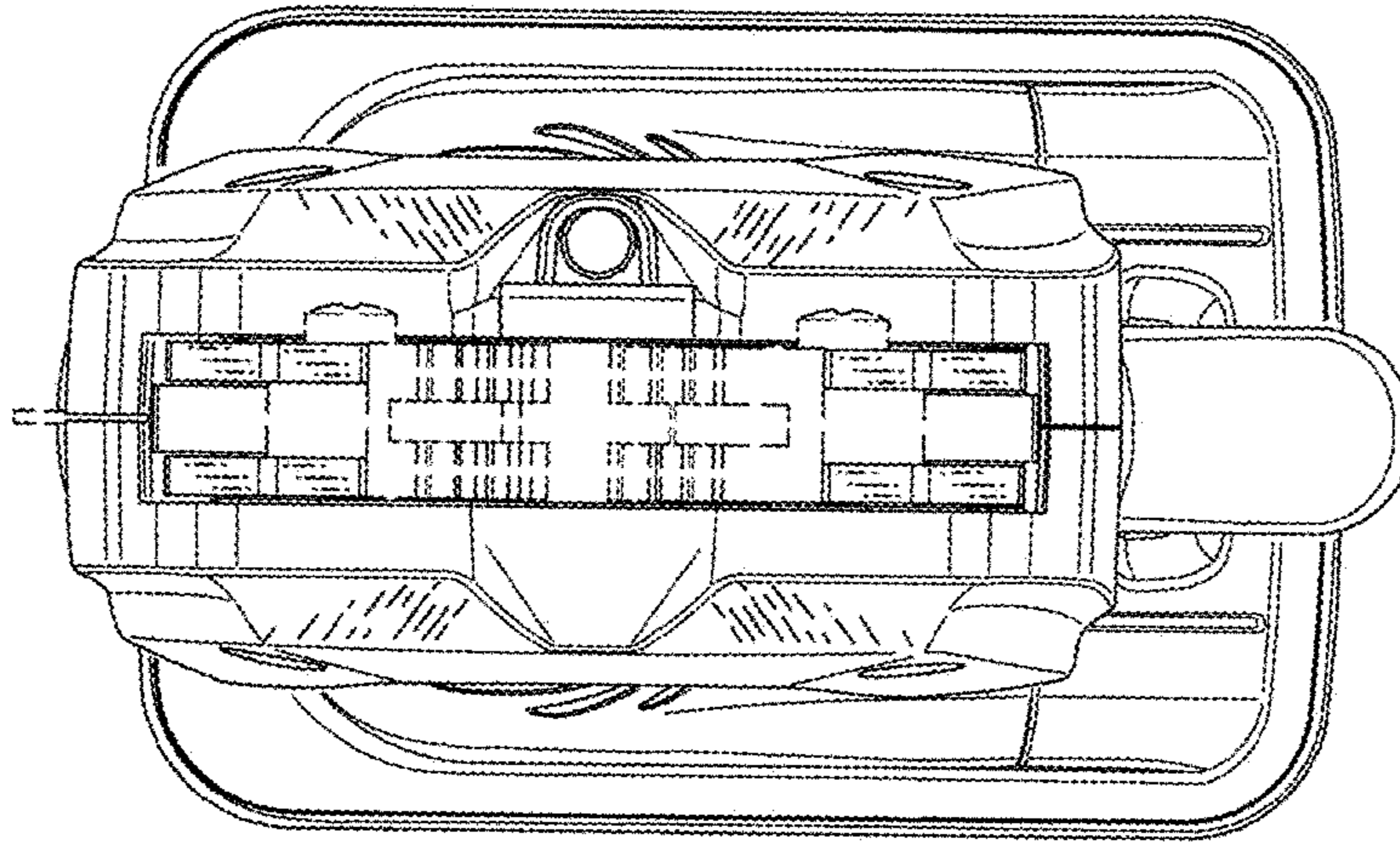

Fig. 6

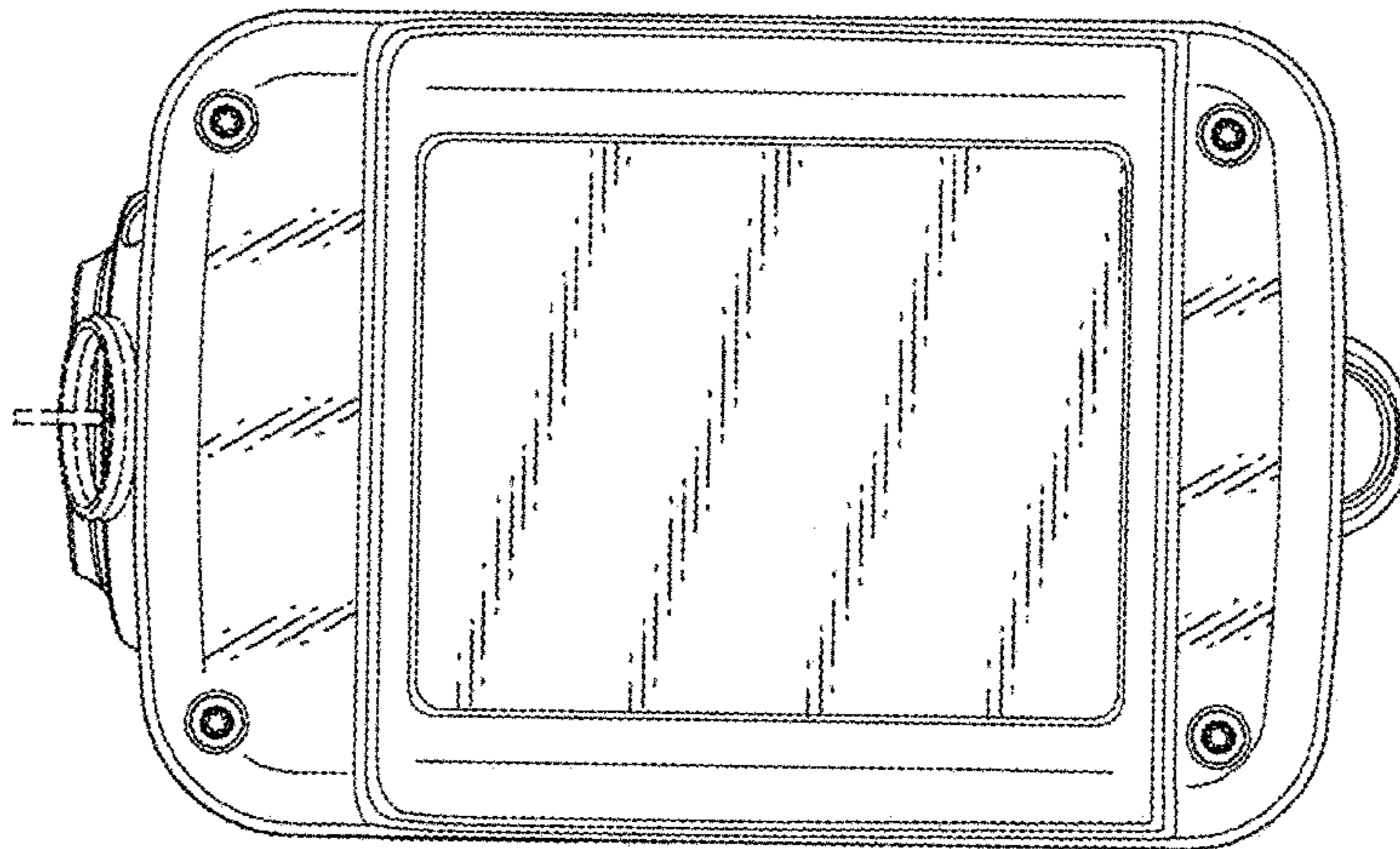

Fig. 7

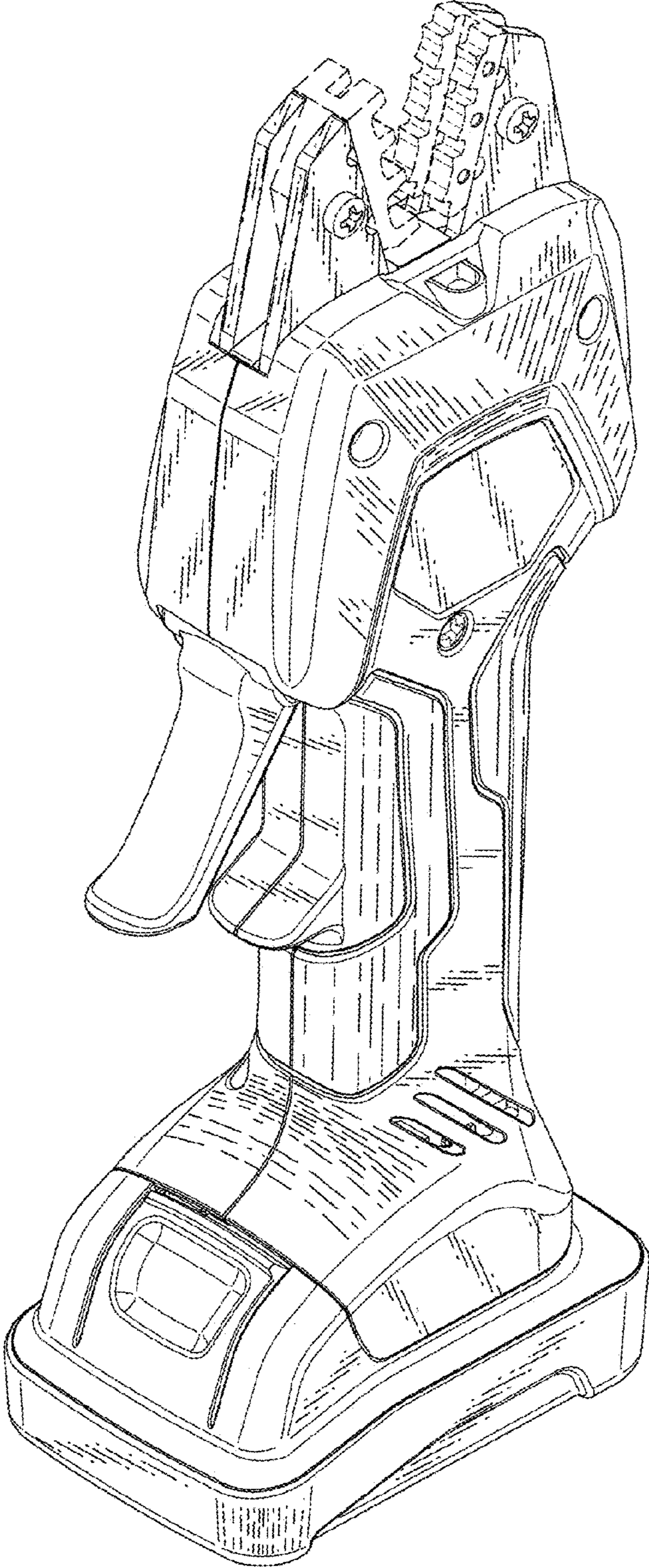

Fig. 8

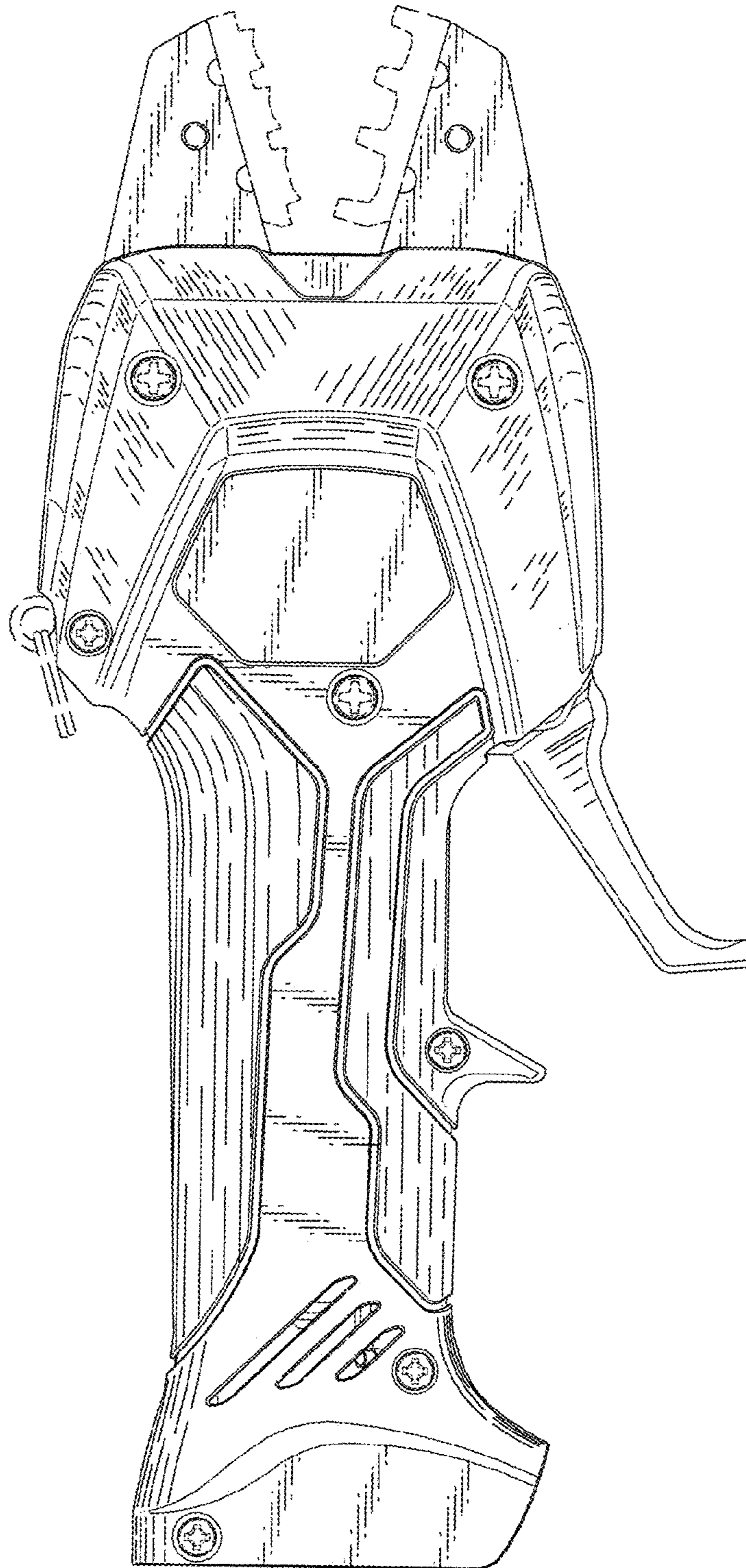

Fig. 9

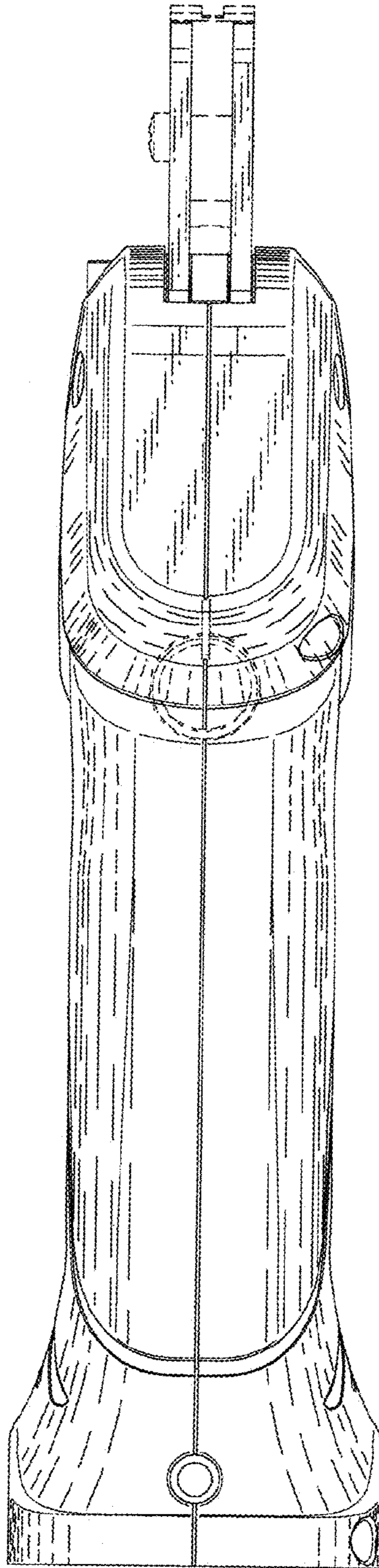

Fig. 10

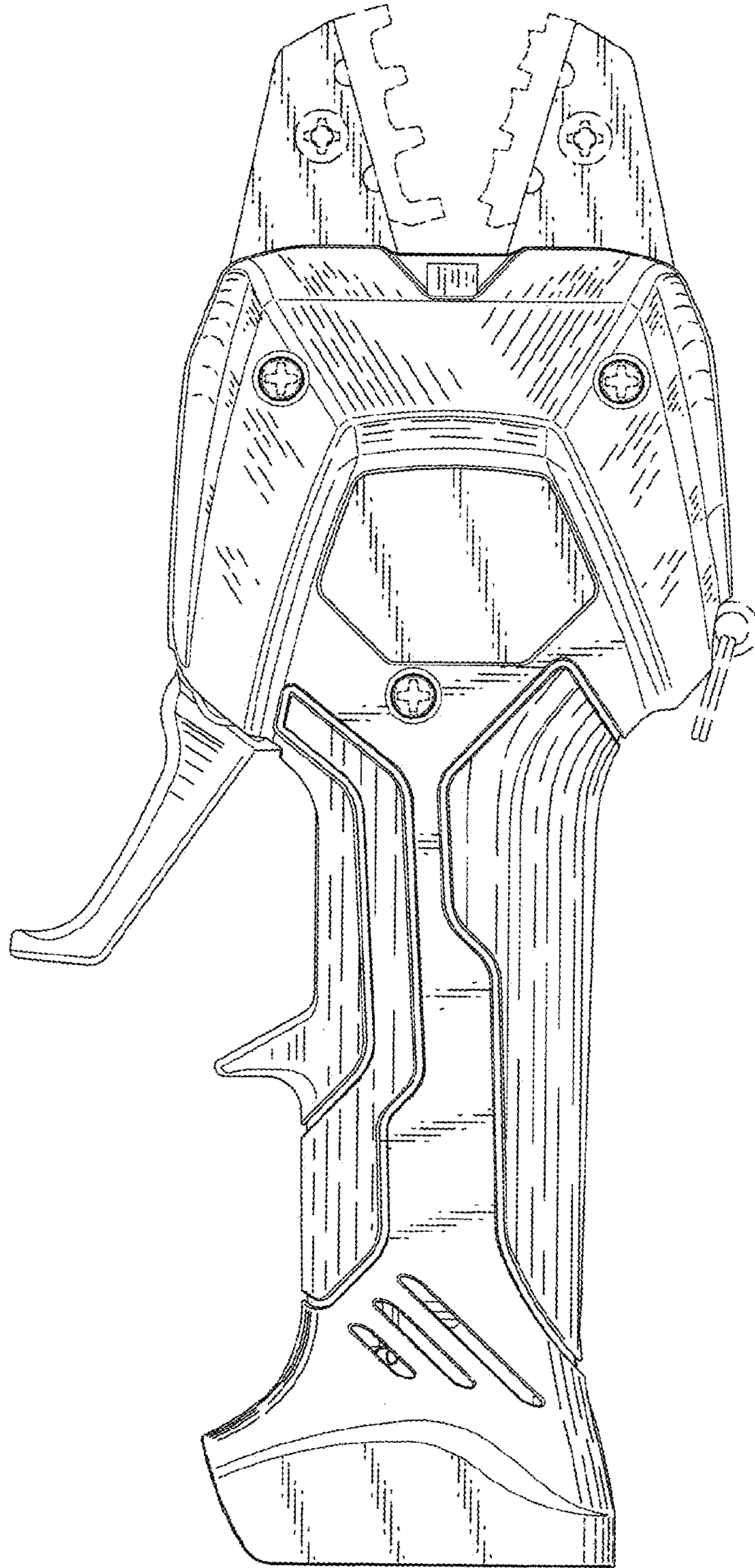

Fig. 11

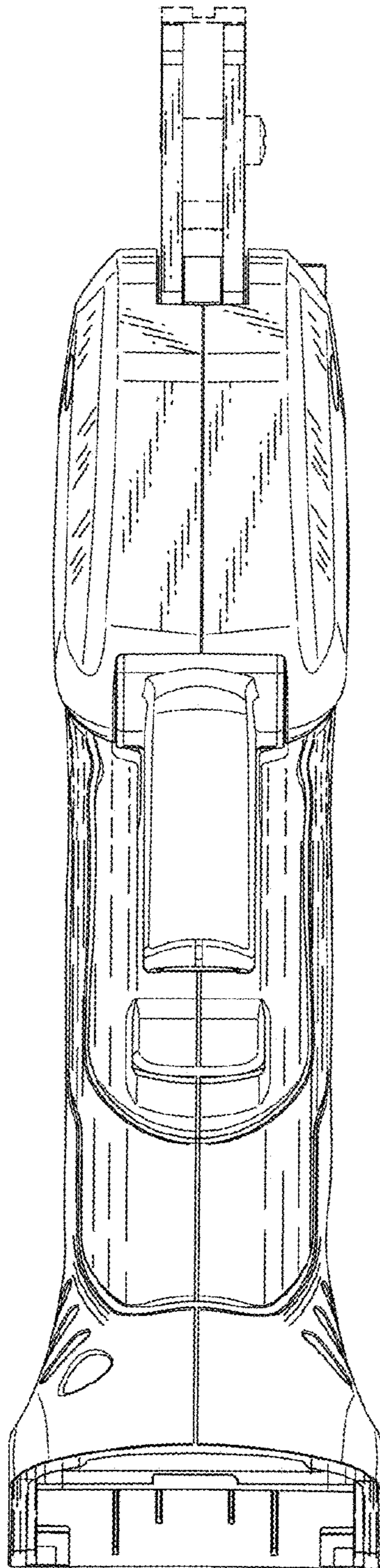

Fig. 12

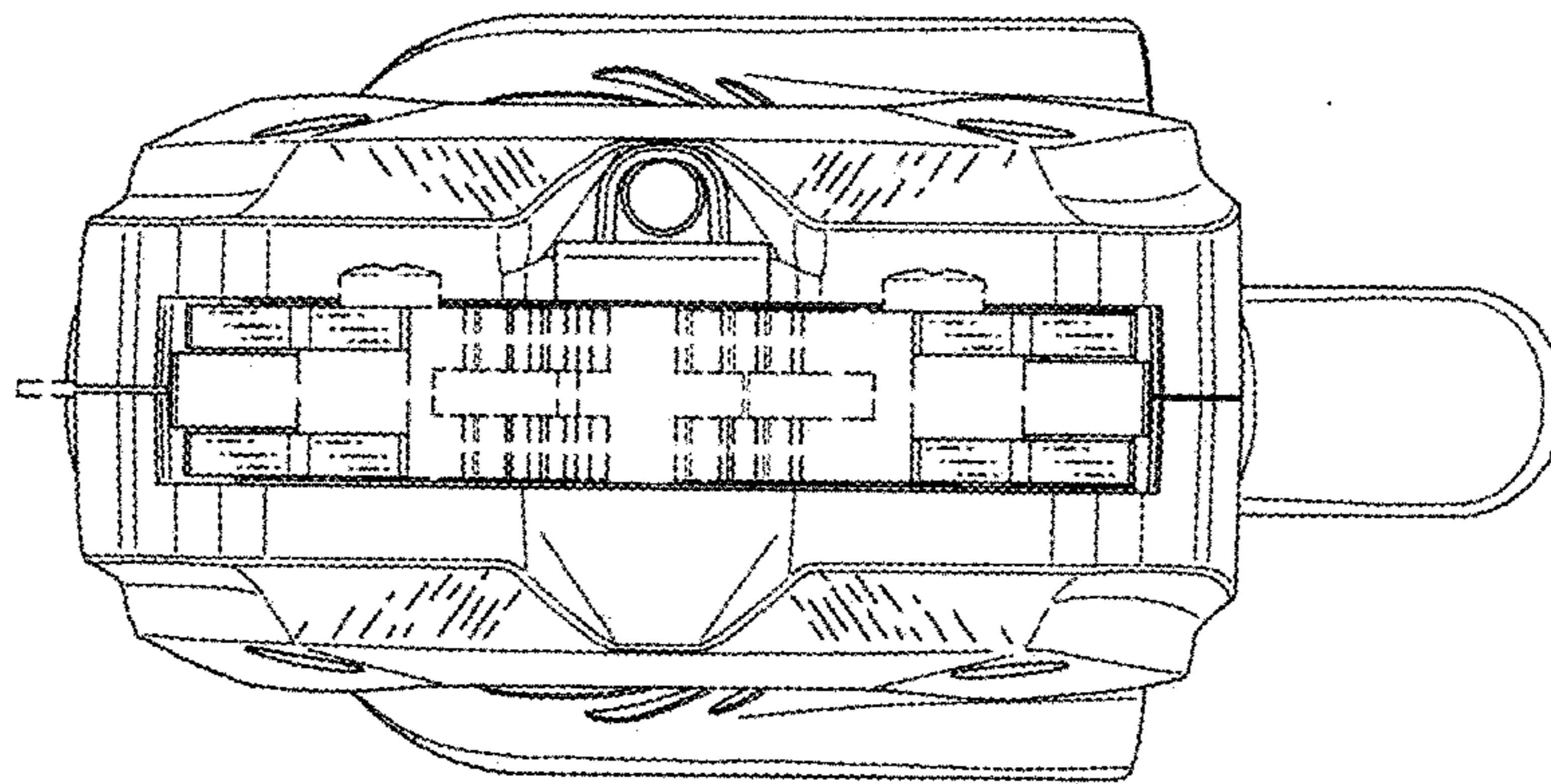

Fig. 13

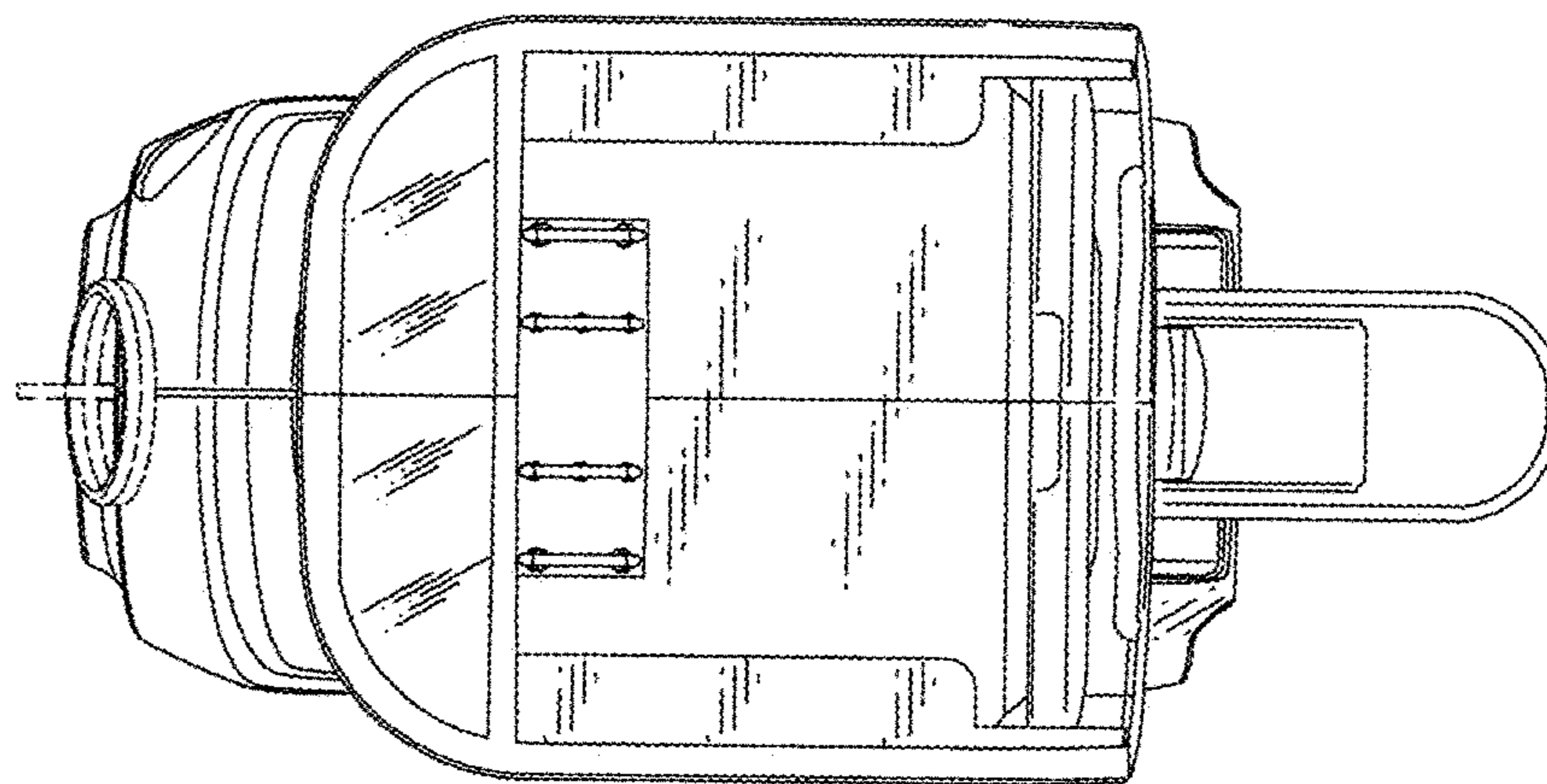

Fig. 14

