

US00D767916S

(12) **United States Design Patent** (10) **Patent No.:** **US D767,916 S**  
**Morrison** (45) **Date of Patent:** **\*\* Oct. 4, 2016**

(54) **ADVERTISING DEVICE FOR DISPENSING  
SANITIZING ARTICLES**

(71) Applicant: **Brian Morrison**, Miami Beach, FL  
(US)

(72) Inventor: **Brian Morrison**, Miami Beach, FL  
(US)

(\*\*) Term: **14 Years**

(21) Appl. No.: **29/525,485**

(22) Filed: **Apr. 30, 2015**

(51) **LOC (10) Cl.** ..... **20-02**

(52) **U.S. Cl.**  
USPC ..... **D6/515**

(58) **Field of Classification Search**  
USPC ..... D6/515-523; 206/389, 391; 211/13.1,  
211/16, 44, 49.1, 50, 59.2, 86.01; 222/173,  
222/181.1; 221/282, 283; 312/34, 34.8, 22,  
312/309.1  
CPC ..... A47L 13/38; B05B 11/3001; B05B 1/14;  
B05C 17/002; A23B 4/16  
See application file for complete search history.

(56) **References Cited**

**U.S. PATENT DOCUMENTS**

4,605,130	A *	8/1986	Taub	.....	A47F 5/114 211/133.1
D316,787	S *	5/1991	Kelly	.....	D6/515
D330,983	S *	11/1992	De Moss	.....	D20/1
D372,613	S	8/1996	Nixon, II		
5,632,418	A *	5/1997	Brown	.....	A47K 5/1202 222/153.09
D388,991	S	1/1998	Thomas et al.		
5,717,374	A	2/1998	Smith		
5,810,201	A	9/1998	Besse et al.		
5,865,340	A	2/1999	Alvern		
D419,804	S	2/2000	Reitman		
D431,931	S	10/2000	Sicignano, III		
D463,928	S	10/2002	Kauzlarich et al.		

6,691,897	B2	2/2004	Ashe		
6,783,028	B1	8/2004	Ambrose et al.		
6,866,166	B2	3/2005	Mehes et al.		
7,131,468	B2	11/2006	Schuman et al.		
D572,955	S	7/2008	Barcena Zafra		
D578,328	S	10/2008	Plum et al.		
D586,598	S	2/2009	Tefel et al.		
D594,260	S	6/2009	Pattberg		
D604,973	S	12/2009	Morrison et al.		
D604,974	S	12/2009	Morrison et al.		
D625,536	S *	10/2010	Moed	.....	D6/518
8,181,865	B2 *	5/2012	Daily	.....	G06Q 30/06 235/380
D670,113	S	11/2012	Morrison		
D670,114	S	11/2012	Morrison et al.		
2006/0155600	A1	7/2006	Mays		
2007/0023455	A1	2/2007	Krengel et al.		
2007/0137726	A1	6/2007	Yan		
2008/0021779	A1	1/2008	Lynn et al.		
2015/0347875	A1 *	12/2015	Akiyama	.....	G06K 15/005 358/1.15

\* cited by examiner

*Primary Examiner* — David Muller  
*Assistant Examiner* — Nathan Johnston  
(74) *Attorney, Agent, or Firm* — GrayRobinson, PA;  
Donald S. Showalter

(57) **CLAIM**  
The ornamental design of an advertising device for dispensing sanitizing articles, as shown and described.

**DESCRIPTION**

FIG. 1 is a perspective view of an advertising device for dispensing sanitizing articles showing my new design; FIG. 2 is a front elevation view thereof; FIG. 3 is a rear elevation view thereof; FIG. 4 is a left side elevation view thereof; FIG. 5 is a right side elevation view thereof; FIG. 6 is a top plan view thereof; and, FIG. 7 is a bottom plan view thereof. The broken lines form no part of the claimed design.

**1 Claim, 6 Drawing Sheets**

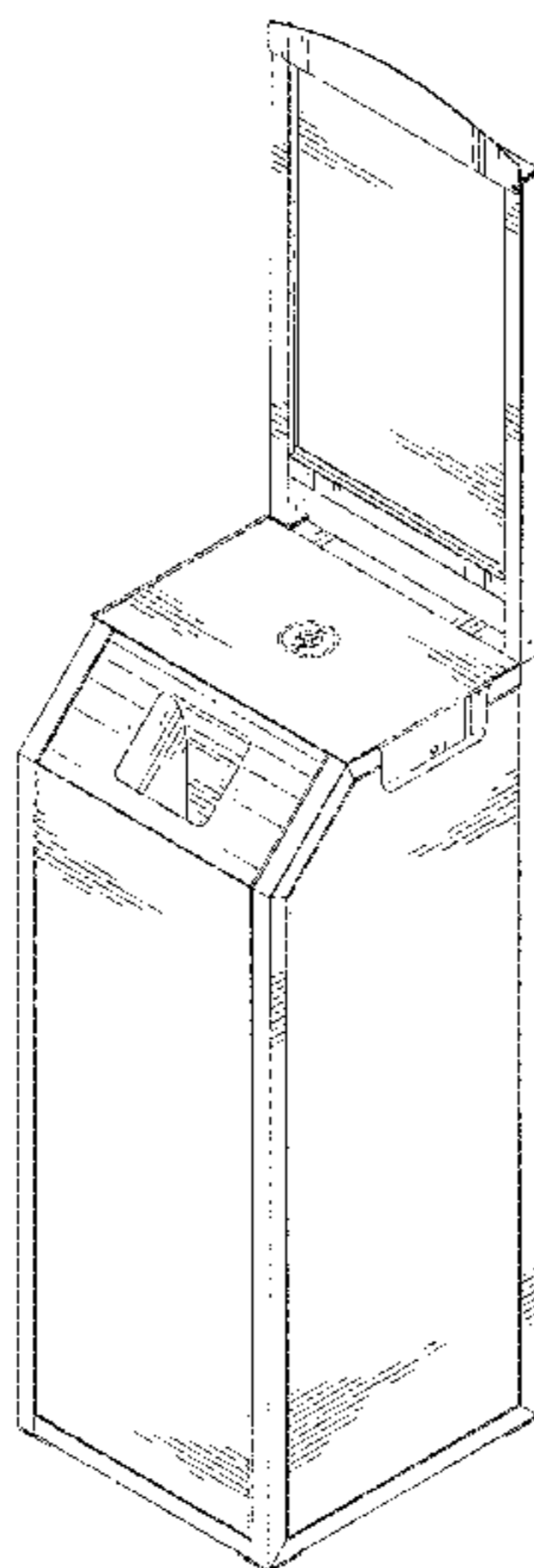

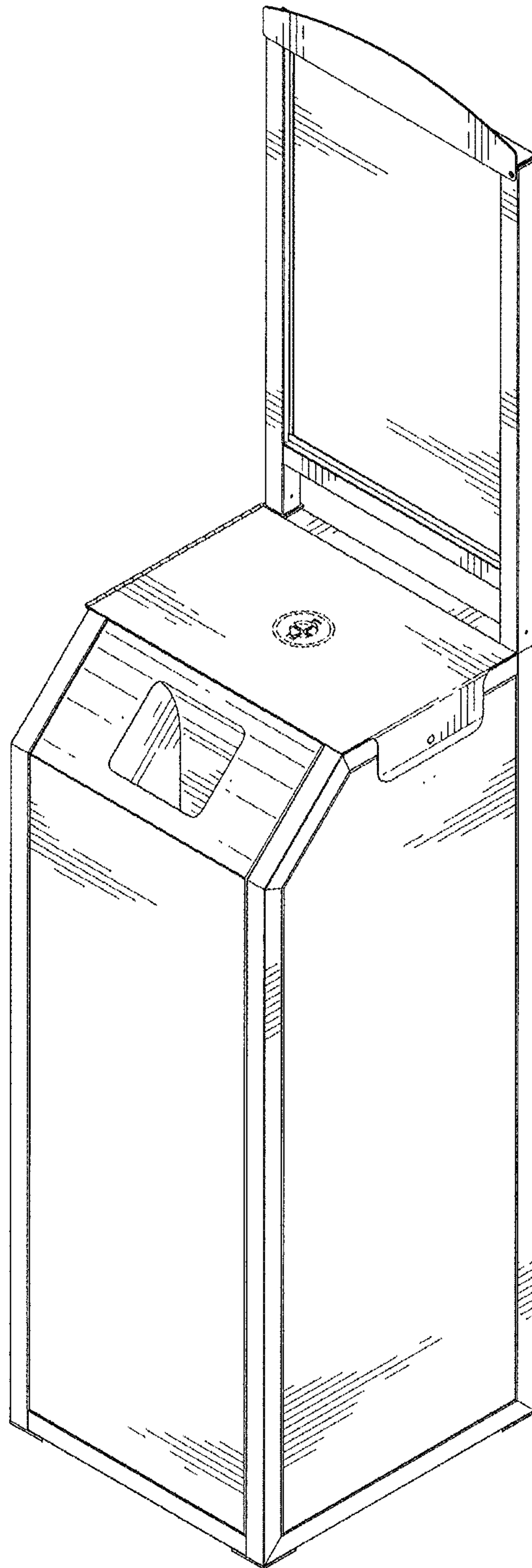

FIG. 1

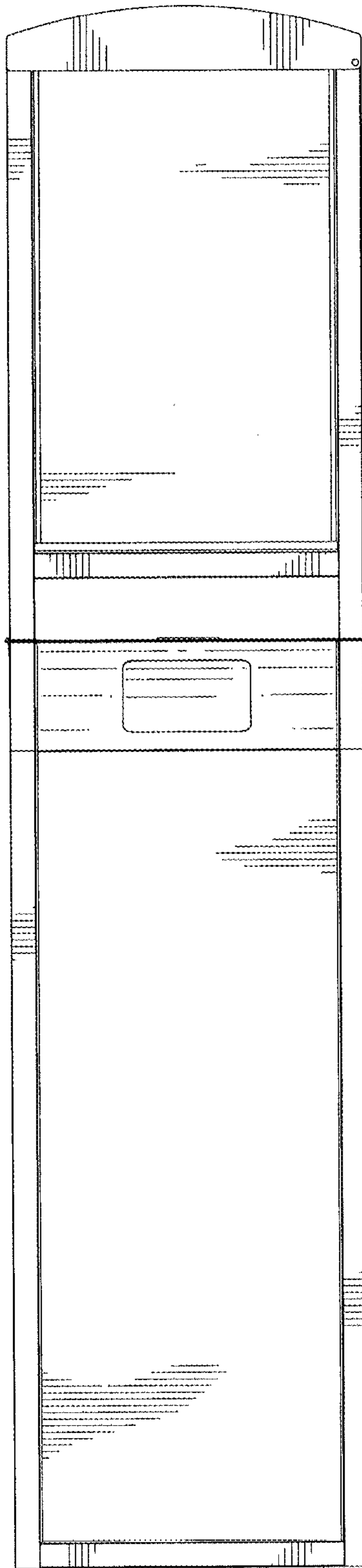

FIG. 2

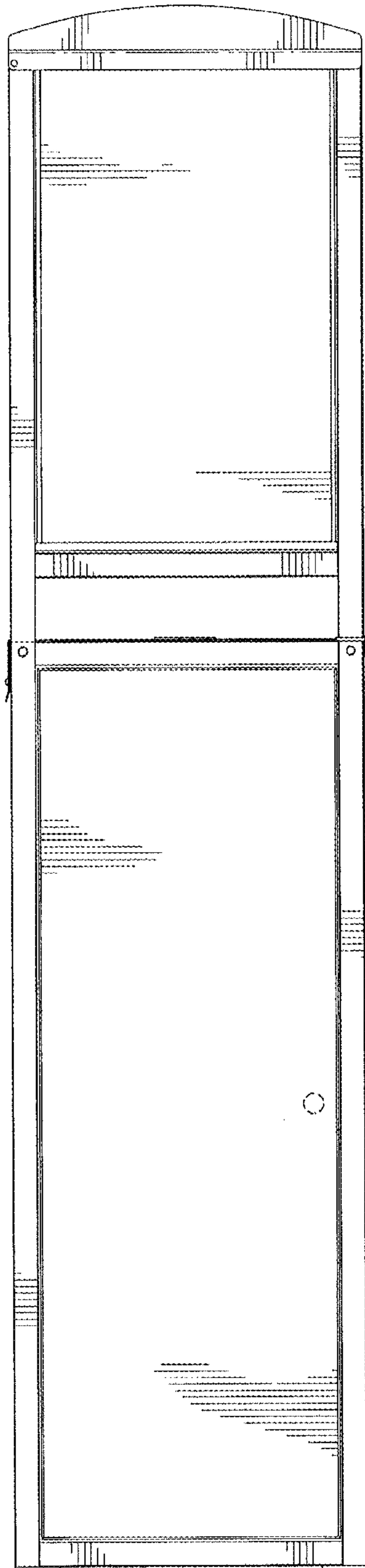

FIG. 3

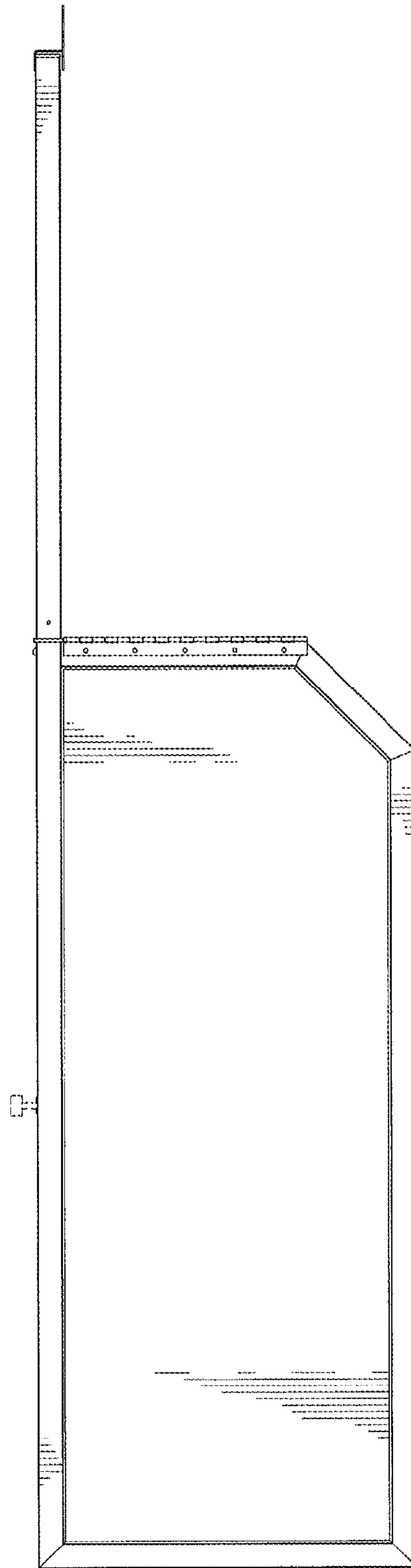

FIG. 4

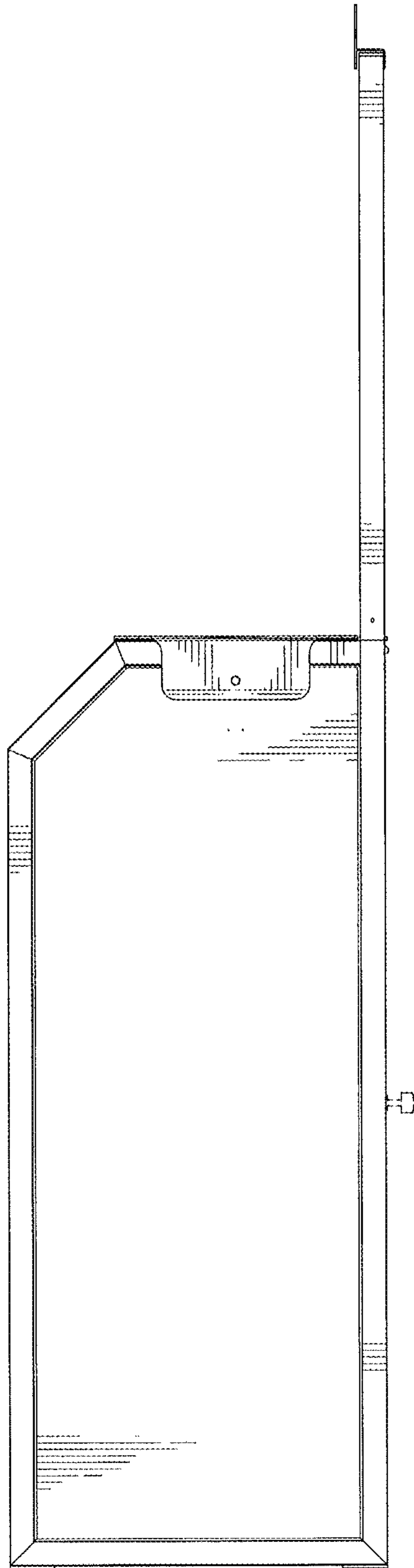

FIG. 5

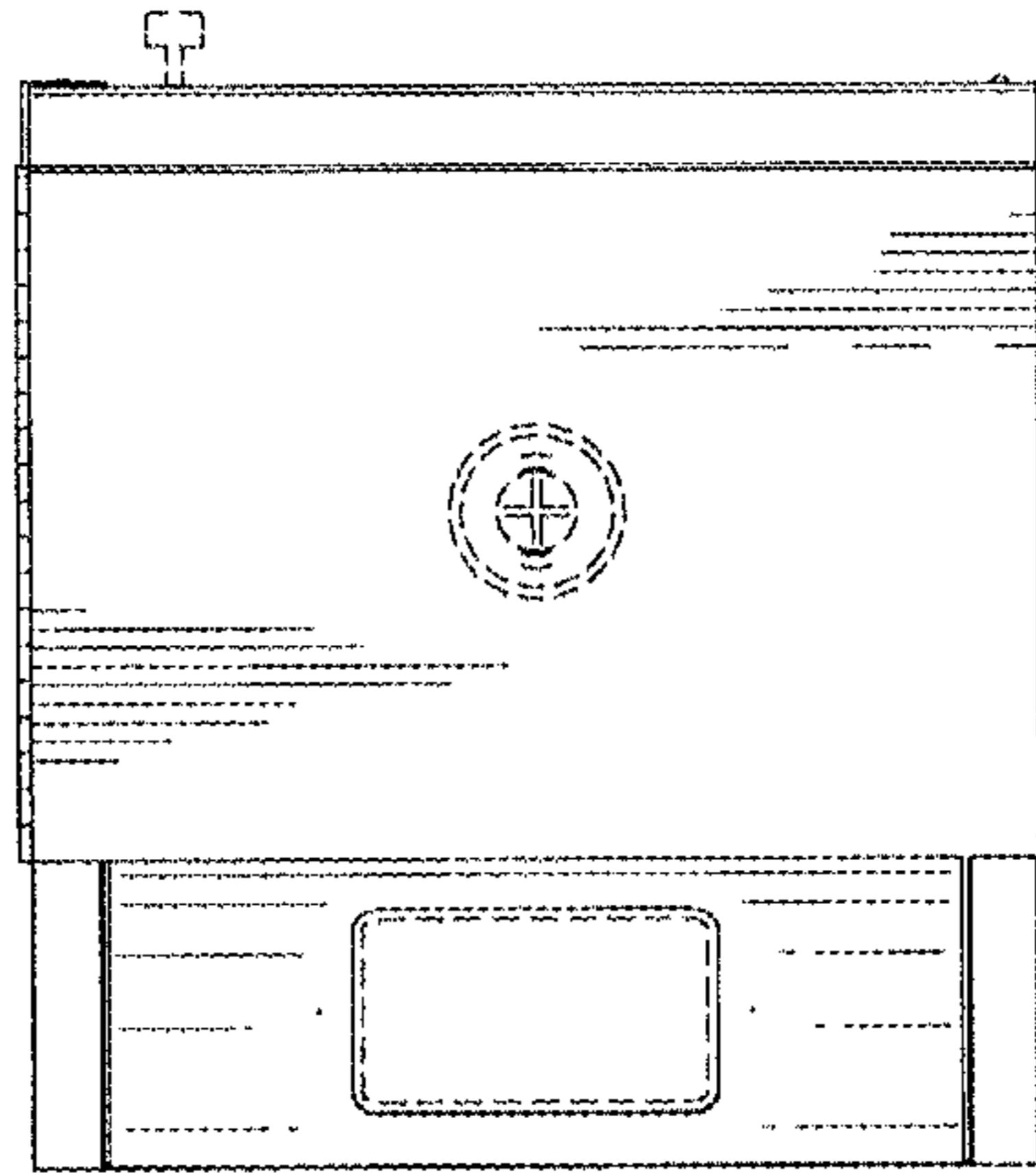

FIG. 6

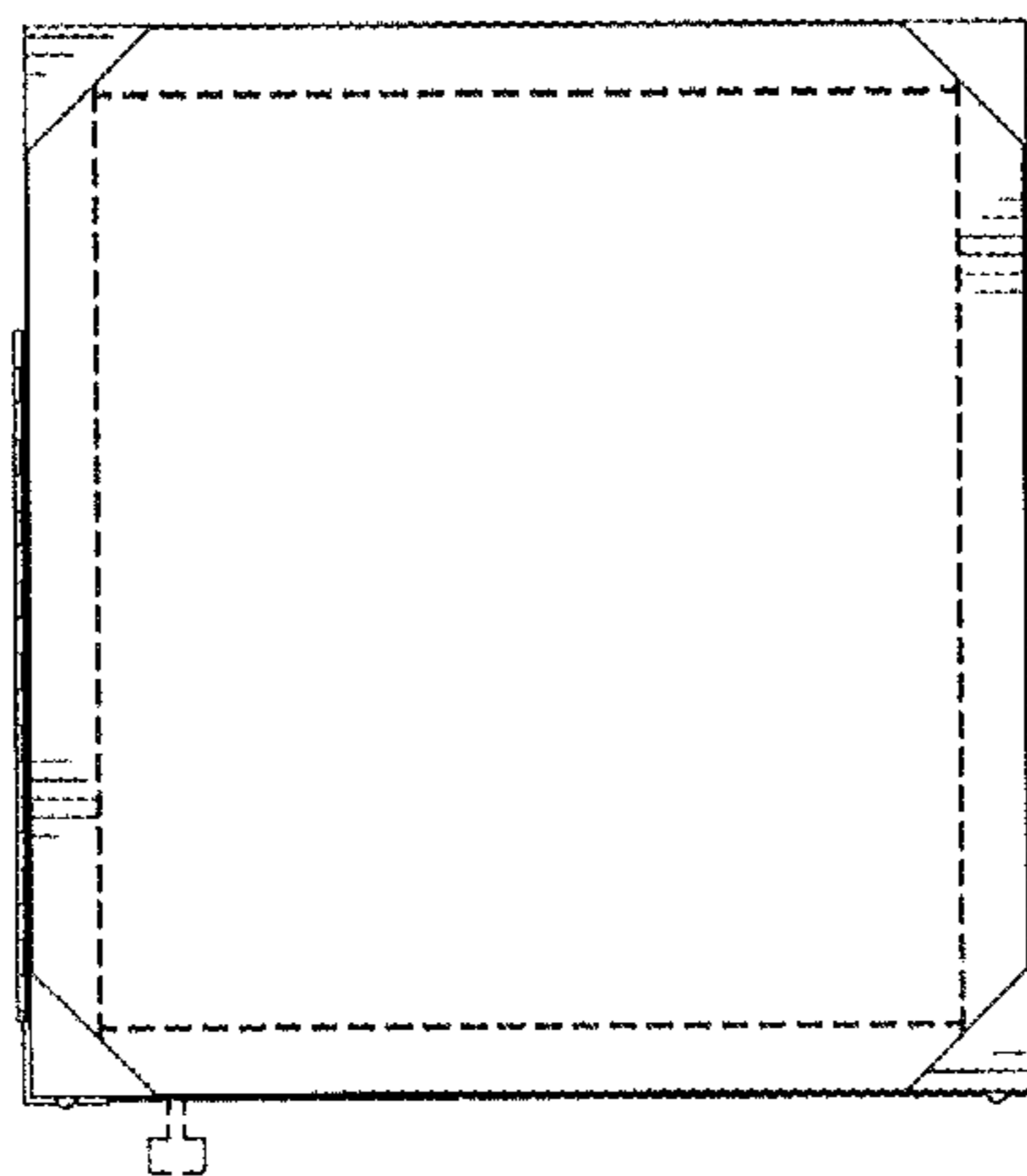

FIG. 7