



US00D767821S

(12) **United States Design Patent**
Clark et al.

(10) **Patent No.:** **US D767,821 S**
(45) **Date of Patent:** **** Sep. 27, 2016**

- (54) **PLASTIC CIGAR PACK**
- (71) Applicant: **ALTRIA CLIENT SERVICES INC.**,
Richmond, VA (US)
- (72) Inventors: **James Lindsay Clark**, Chesterfield, VA
(US); **Robert T. Mitten**, Glen Allen,
VA (US); **Benjamin Ragland**,
Providence Forge, VA (US); **Gary**
Wessling, Burlington, NJ (US)
- (73) Assignee: **ALTRIA CLIENT SERVICES LLC**,
Richmond, VA (US)
- (**) Term: **14 Years**
- (21) Appl. No.: **29/526,707**
- (22) Filed: **May 12, 2015**
- (51) **LOC (10) Cl.** **27-06**
- (52) **U.S. Cl.**
USPC **D27/189**
- (58) **Field of Classification Search**
USPC D3/20, 206, 252; D13/107, 118, 119,
D13/184; D19/23, 115; D27/100, 101, 162,
D27/170, 175, 183, 186, 187, 189, 193,
D27/194; D14/203.4; D9/759
CPC A24F 47/008; A24F 47/002; A24F 15/18;
A24F 13/02; A24F 13/06; A24F 15/00;
A24F 7/04
See application file for complete search history.

- D386,812 S * 11/1997 Schmidt D27/187
- 5,829,581 A 11/1998 Wicker
- 5,832,934 A 11/1998 Schmidt
- D414,892 S 10/1999 Chen
- D422,460 S 4/2000 Haner et al.
- D422,785 S 4/2000 Cavell
- D427,433 S * 7/2000 Leibeck D27/189
- 6,298,857 B1 10/2001 Schmidt

(Continued)

FOREIGN PATENT DOCUMENTS

- DE 20104364 U1 7/2001
- EP 1240836 A1 9/2002
- WO 01/56411 A1 8/2001

Primary Examiner — Robert M Spear
Assistant Examiner — Marissa J Cash

(74) *Attorney, Agent, or Firm* — Roberts Mlotkowski;
Safran Cole & Calderon, P.C.

(57) **CLAIM**

We claim the ornamental design for a plastic cigar pack, as shown and described.

DESCRIPTION

FIG. 1 is a front perspective view of a transparent plastic cigar pack, showing my new design;
 FIG. 2 is a front elevational view of a transparent plastic cigar pack;
 FIG. 3 is a rear elevational view of a transparent plastic cigar pack;
 FIG. 4 is a left-side elevational view of a transparent plastic cigar pack;
 FIG. 5 is a right-side elevational view of a transparent plastic cigar pack;
 FIG. 6 is a top plan view of a transparent plastic cigar pack;
 FIG. 7 is a bottom plan view of a transparent plastic cigar pack; and,
 FIG. 8 is an exploded front perspective view of a transparent plastic cigar pack.

1 Claim, 5 Drawing Sheets

(56) **References Cited**

U.S. PATENT DOCUMENTS

- 1,430,637 A 10/1922 Gaede
- 2,010,440 A * 8/1935 Ryan A24F 25/02
206/205
- D201,401 S 6/1965 Picot
- D229,673 S * 12/1973 Danjczek D9/759
- D239,776 S * 5/1976 Goto D27/157
- D317,127 S 5/1991 Zubek
- D341,315 S 11/1993 Seymour

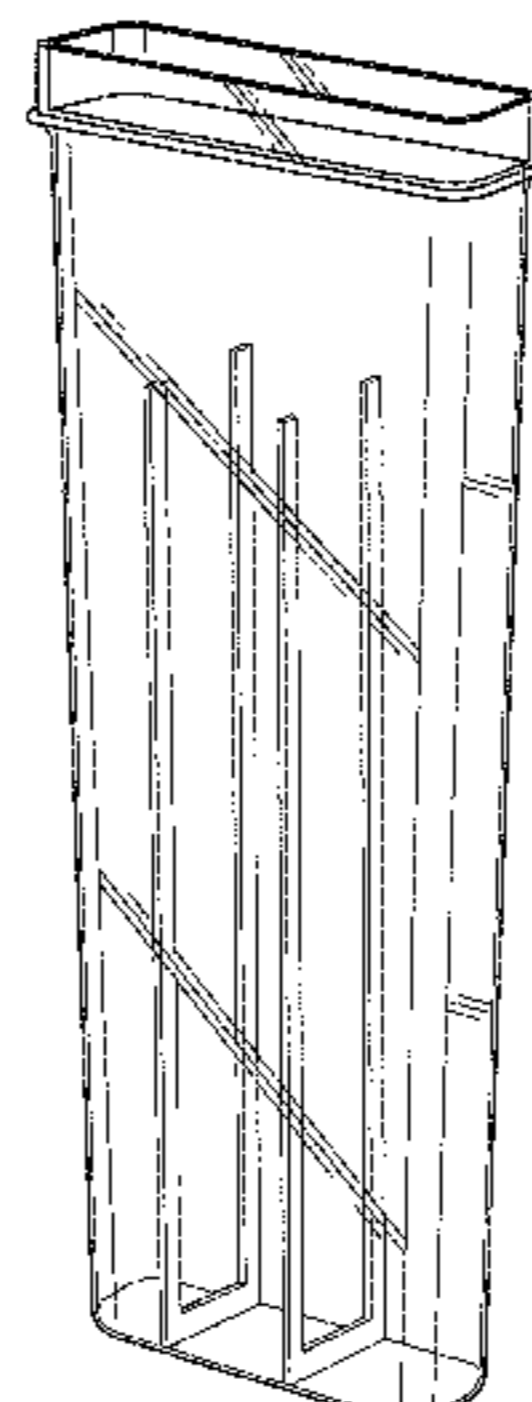
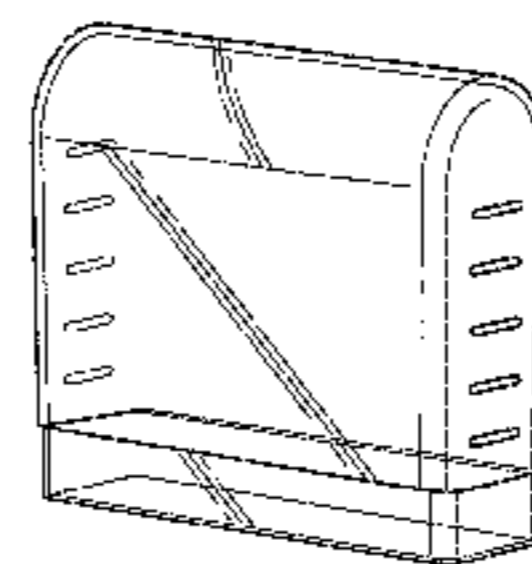
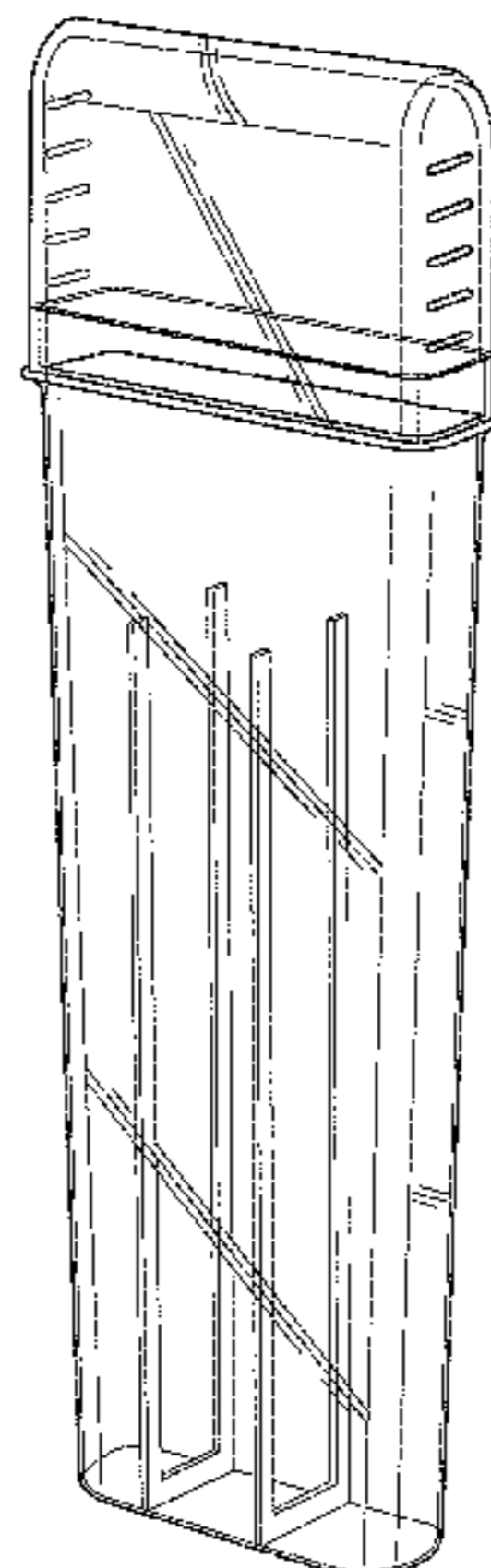

(56)

References Cited

U.S. PATENT DOCUMENTS

D451,546 S 12/2001 Guercio
 D480,174 S * 9/2003 Draghetti D27/189
 D485,939 S * 1/2004 Draghetti D27/189
 D491,806 S 6/2004 May
 D555,284 S 11/2007 Fath
 D616,146 S * 5/2010 Holford D27/189
 D665,734 S * 8/2012 Fitch D13/107
 D683,898 S * 6/2013 Liu D13/108
 D688,418 S * 8/2013 Liu D13/108
 D694,615 S 12/2013 Mombelli
 8,602,210 B2 12/2013 Milner et al.
 D719,701 S * 12/2014 Scatterday D27/189
 D723,734 S * 3/2015 Liu D27/189
 D723,735 S * 3/2015 Liu D27/189

D723,736 S * 3/2015 Liu D27/189
 D723,737 S * 3/2015 Liu D27/189
 D723,738 S * 3/2015 Liu D27/189
 D725,823 S * 3/2015 Scatterday D27/189
 D735,936 S * 8/2015 Liu D27/189
 D736,997 S * 8/2015 Liu D27/189
 D737,506 S * 8/2015 Liu D27/189
 D737,507 S * 8/2015 Liu D27/189
 D737,508 S * 8/2015 Liu D27/189
 2003/0106928 A1* 6/2003 Li Vigni B65D 85/1045
 229/146
 2007/0163608 A1 7/2007 Tarlow
 2014/0216961 A1* 8/2014 Liu A24F 15/12
 206/266
 2015/0114410 A1* 4/2015 Doster A24F 47/008
 131/329

* cited by examiner

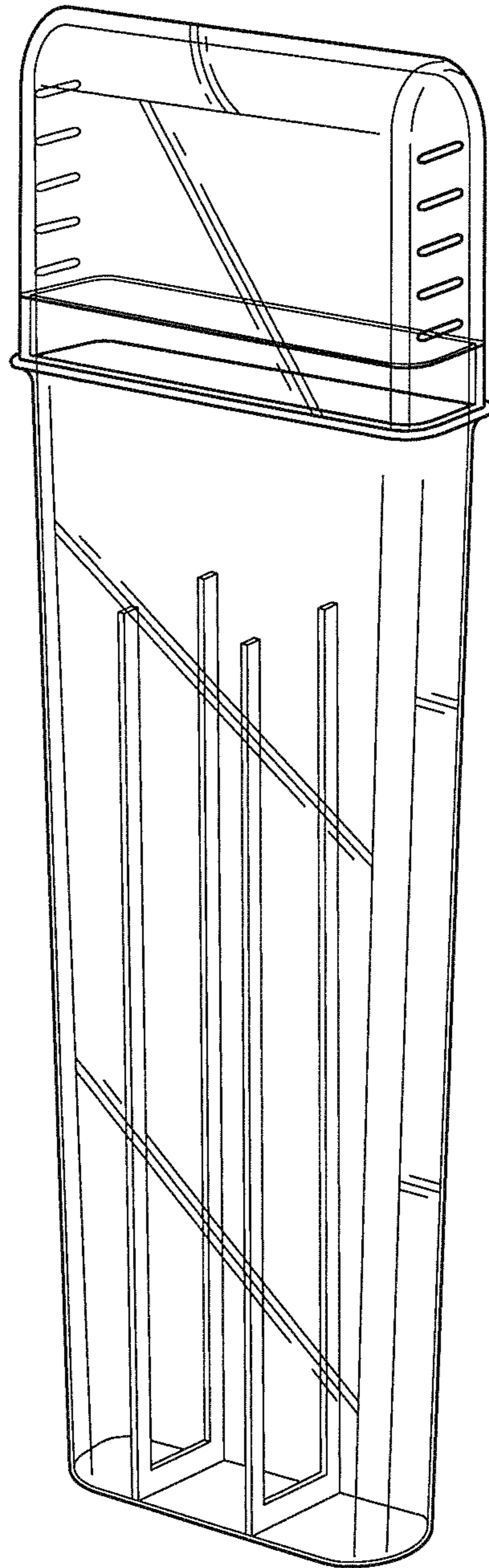

FIG. 1

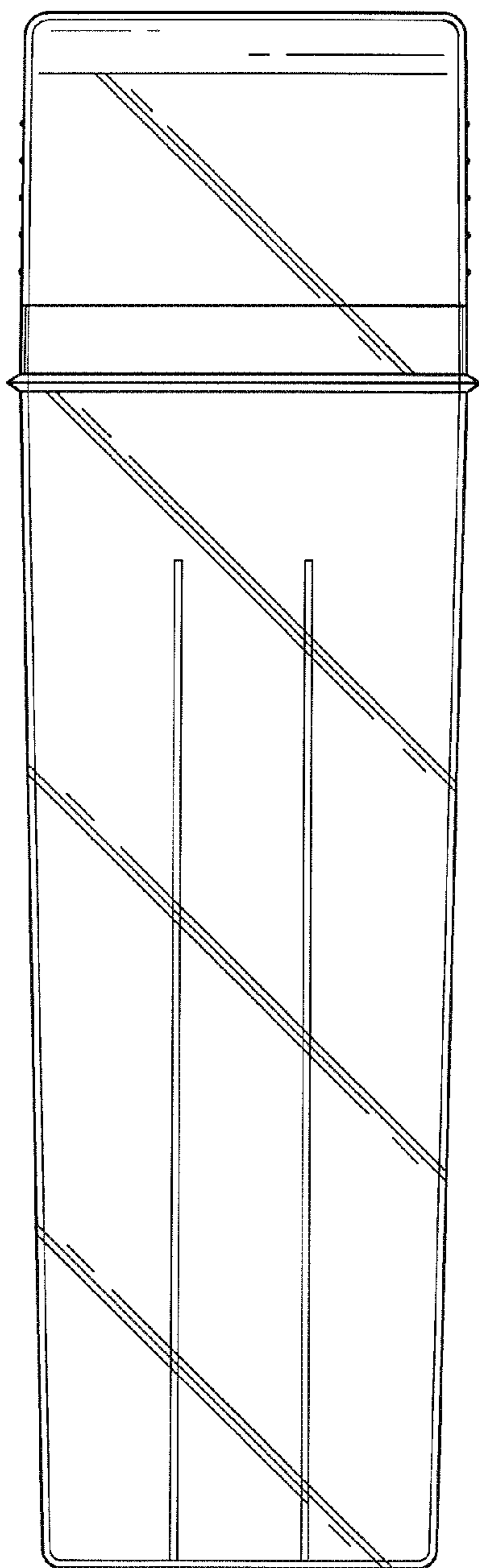

FIG. 2

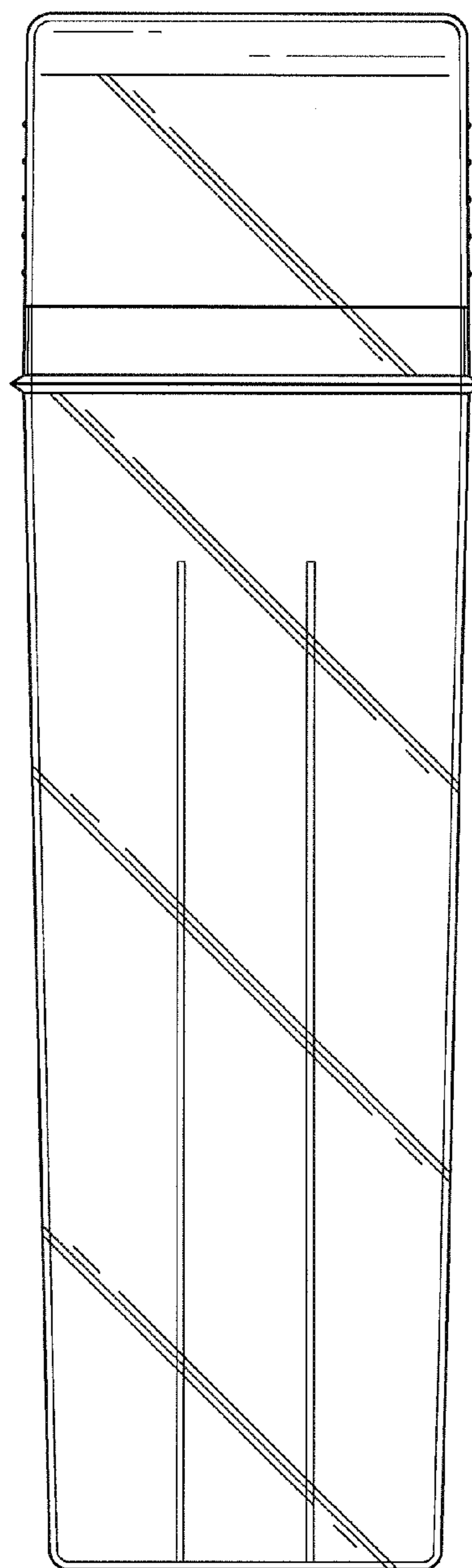

FIG. 3

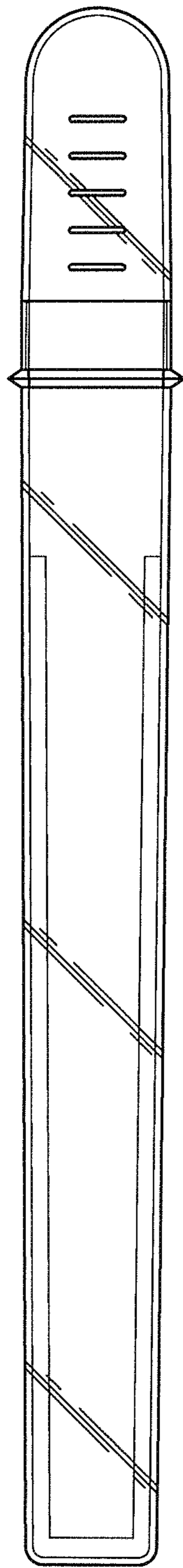

FIG. 4

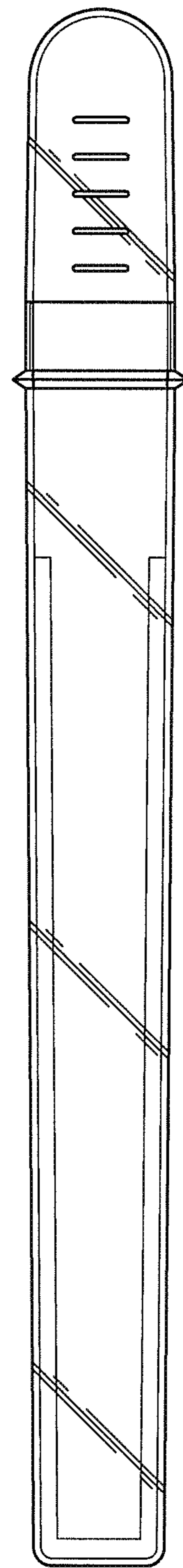

FIG. 5

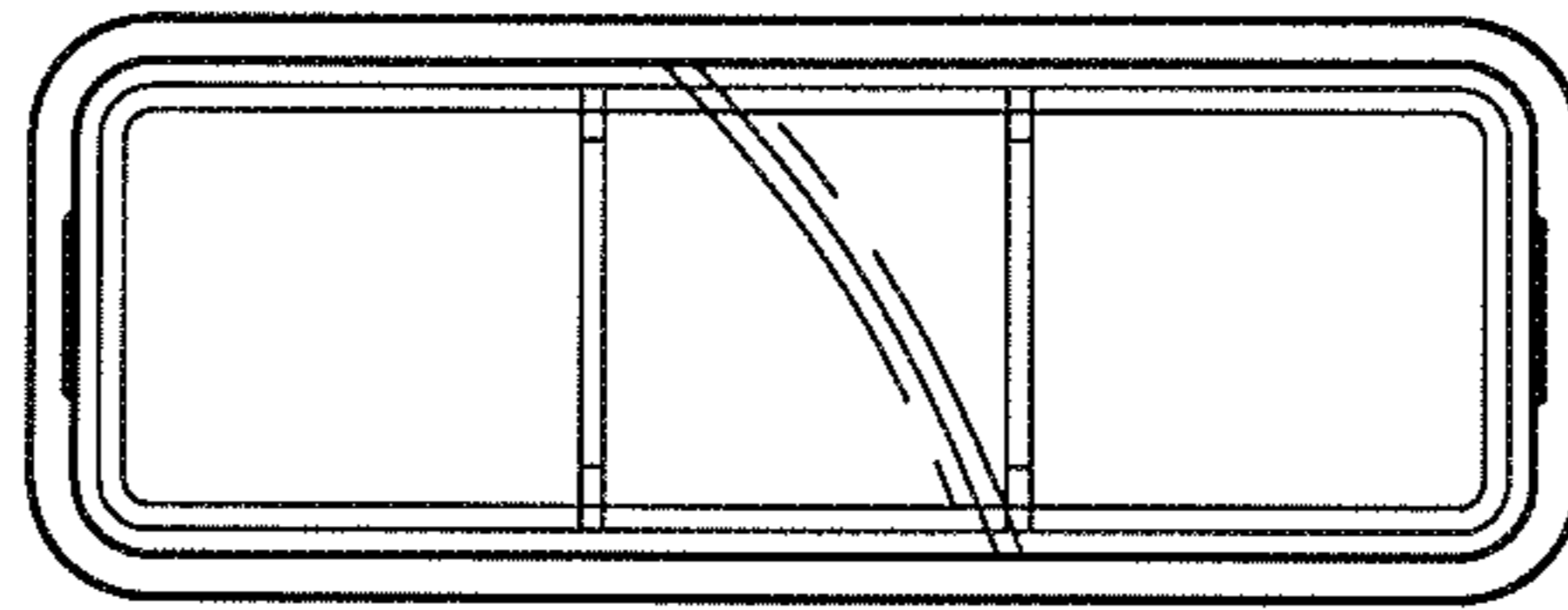

FIG. 6

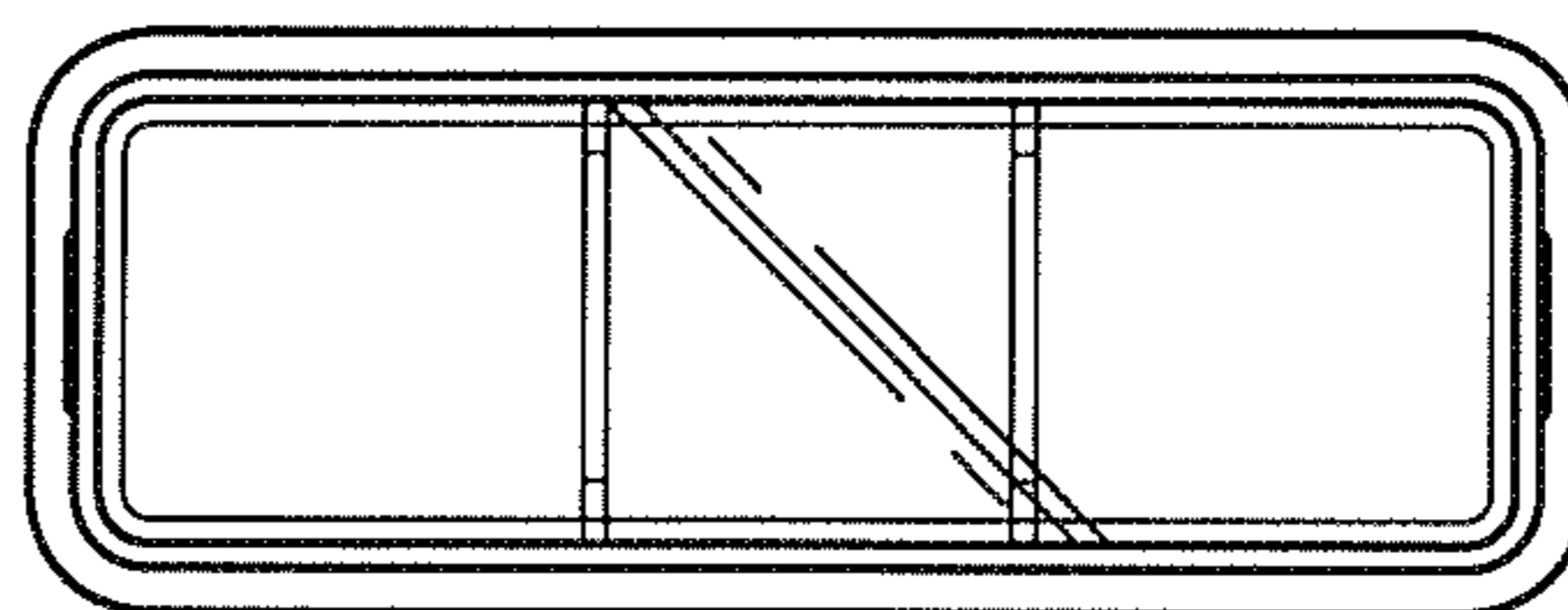

FIG. 7

FIG. 8

