



US00D767812S

(12) **United States Design Patent** (10) **Patent No.:** **US D767,812 S**
Skira (45) **Date of Patent:** **** Sep. 27, 2016**

(54) **LIGHTING APPARATUS** D242,820 S * 12/1976 Parrella D26/104
D452,032 S * 12/2001 Hoffbauer D26/106

(71) Applicant: **IGUZZINI ILLUMINAZIONE S.P.A.**,
Recanati (IT)

* cited by examiner

Primary Examiner — Brian N Vinson

(72) Inventor: **Dean Skira**, Pula (HR)

(74) *Attorney, Agent, or Firm* — Abelman, Frayne & Schwab

(73) Assignee: **IGUZZINI ILLUMINAZIONE S.P.A.**,
Recanati (IT)

(57) **CLAIM**

(**) Term: **14 Years**

The ornamental design for a lighting apparatus, as shown and described.

(21) Appl. No.: **29/503,006**

(22) Filed: **Sep. 22, 2014**

DESCRIPTION

(30) **Foreign Application Priority Data**

Mar. 21, 2014 (EM) 0024300900005

(51) **LOC (10) Cl.** **26-05**

(52) **U.S. Cl.**
USPC **D26/106**

(58) **Field of Classification Search**
USPC D26/24, 93, 94, 102, 104, 106, 10, 8
CPC G09F 13/26; F21S 6/00; F21S 6/002;
F21V 21/02; F21W 2121/00
See application file for complete search history.

FIG. 1 is a top, front and left side perspective view of the lighting apparatus showing my new design;
FIG. 2 is a front elevational view thereof;
FIG. 3 is a right side elevational view thereof;
FIG. 4 is a left side elevational view thereof;
FIG. 5 is a rear elevational view thereof;
FIG. 6 is a top plan view thereof; and,
FIG. 7 is a bottom view thereof.

(56) **References Cited**

U.S. PATENT DOCUMENTS

1,977,575 A * 10/1934 Drake G09F 13/26
362/216

The broken lines shown on the drawings depict portions of the lighting apparatus that form no part of the claimed design.

1 Claim, 7 Drawing Sheets

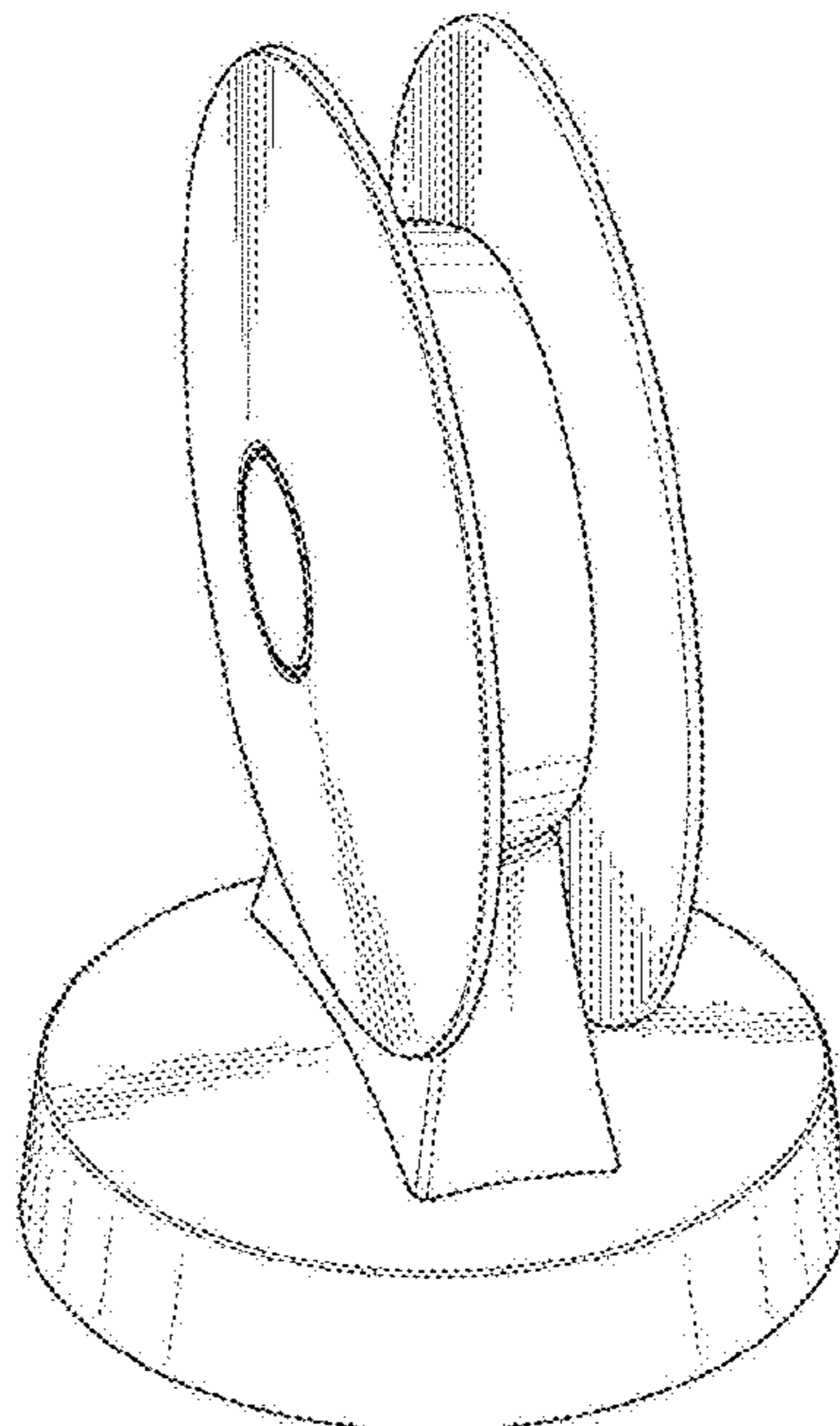

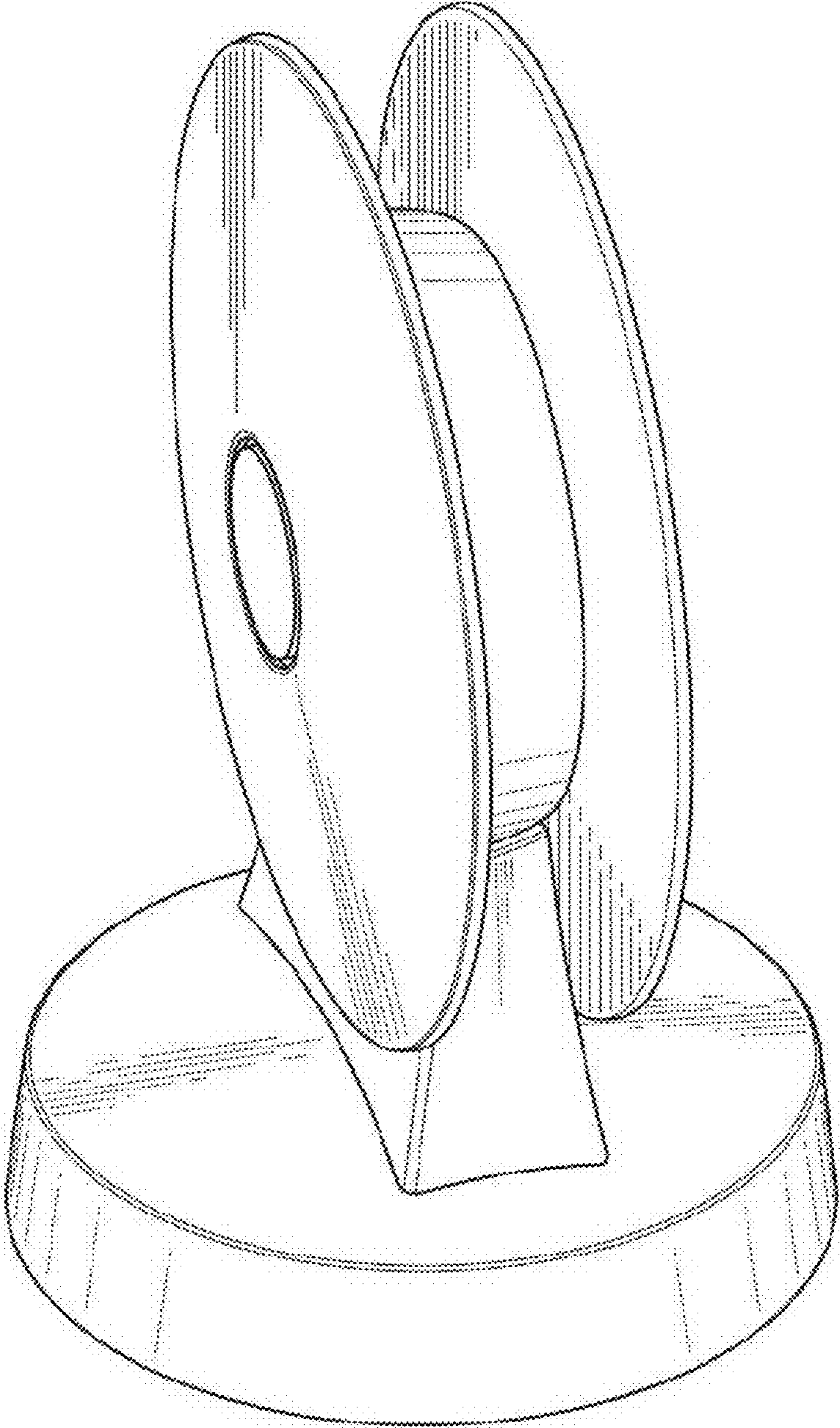

Fig. 1

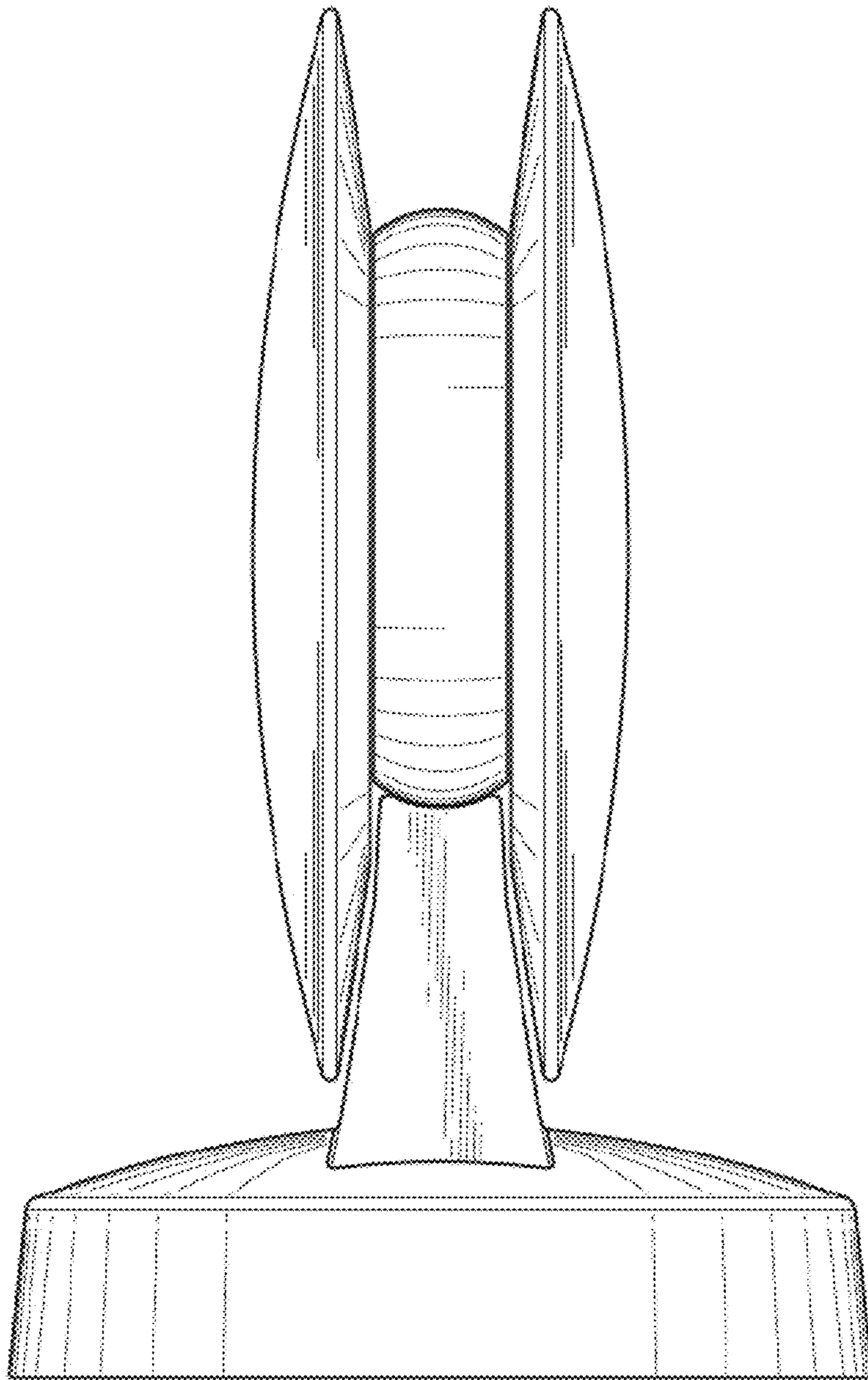

Fig. 2

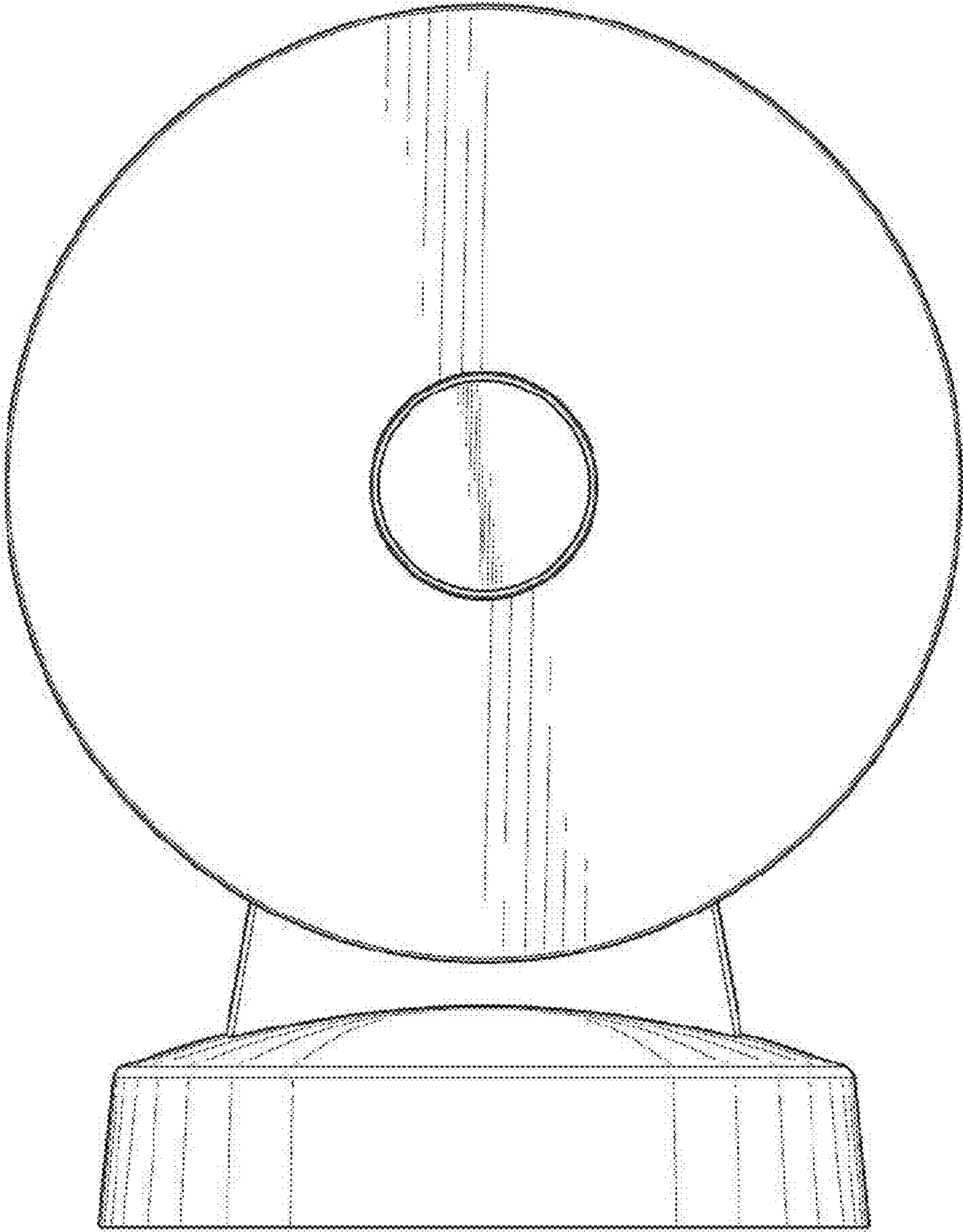

Fig. 3

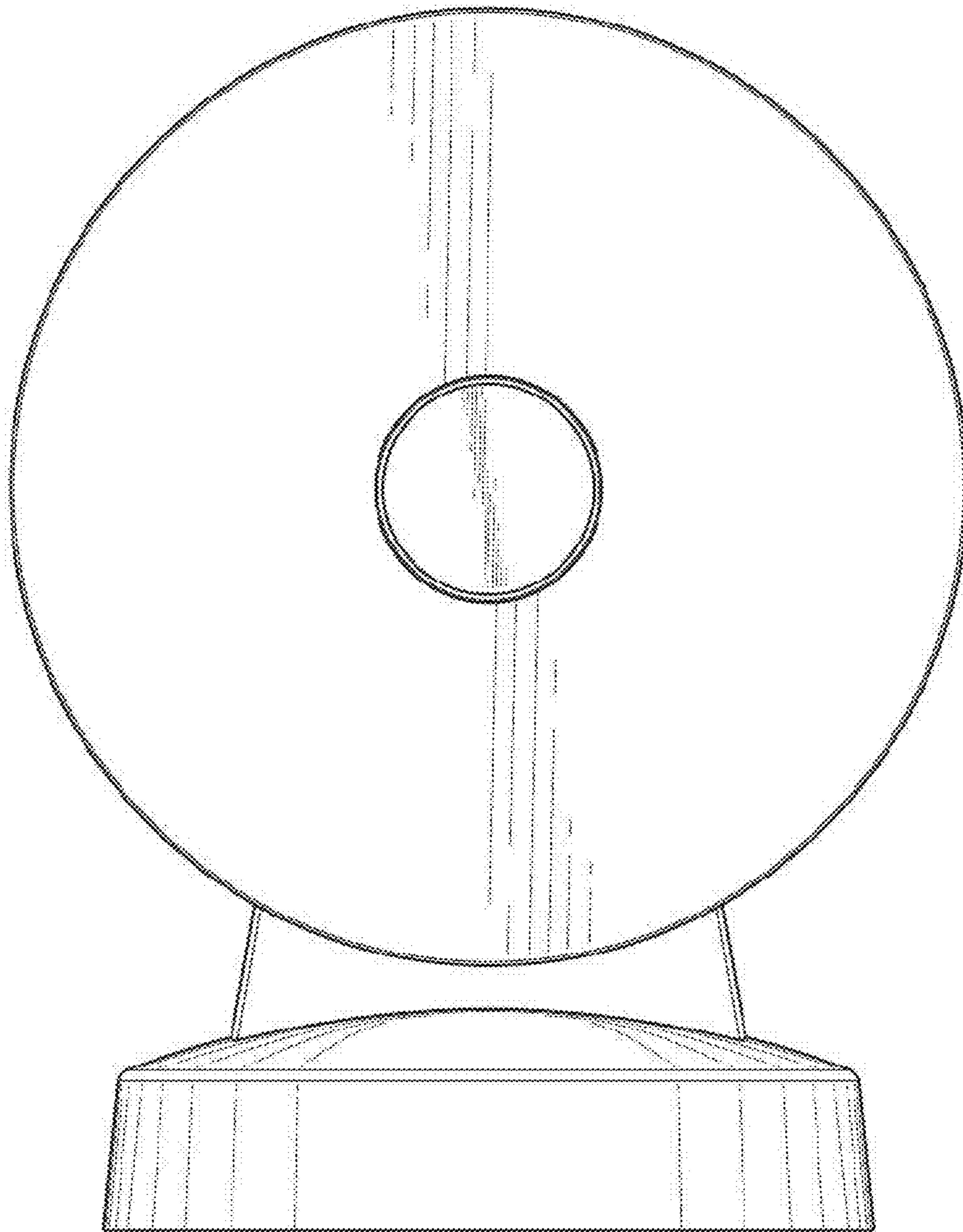

Fig. 4

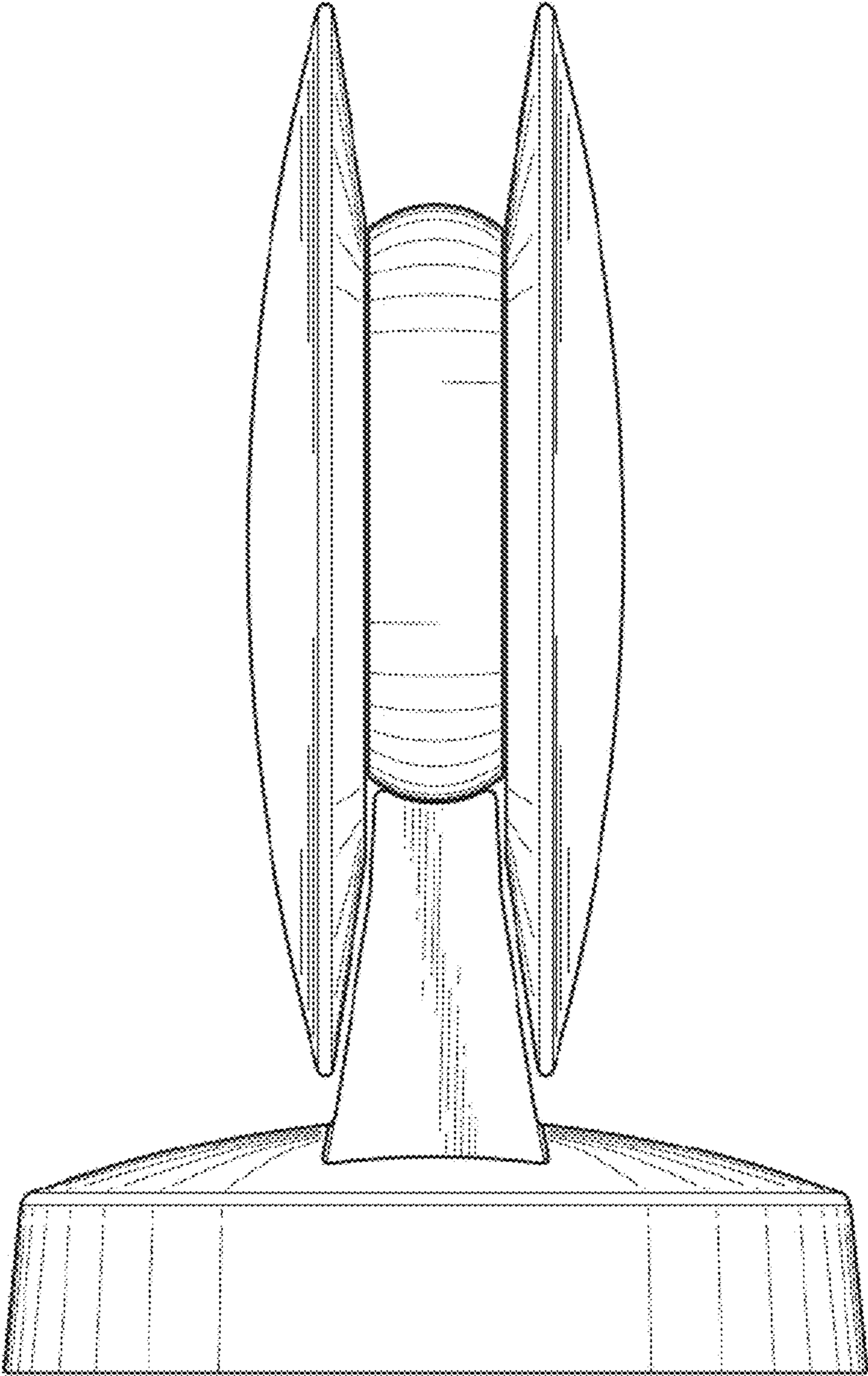

Fig. 5

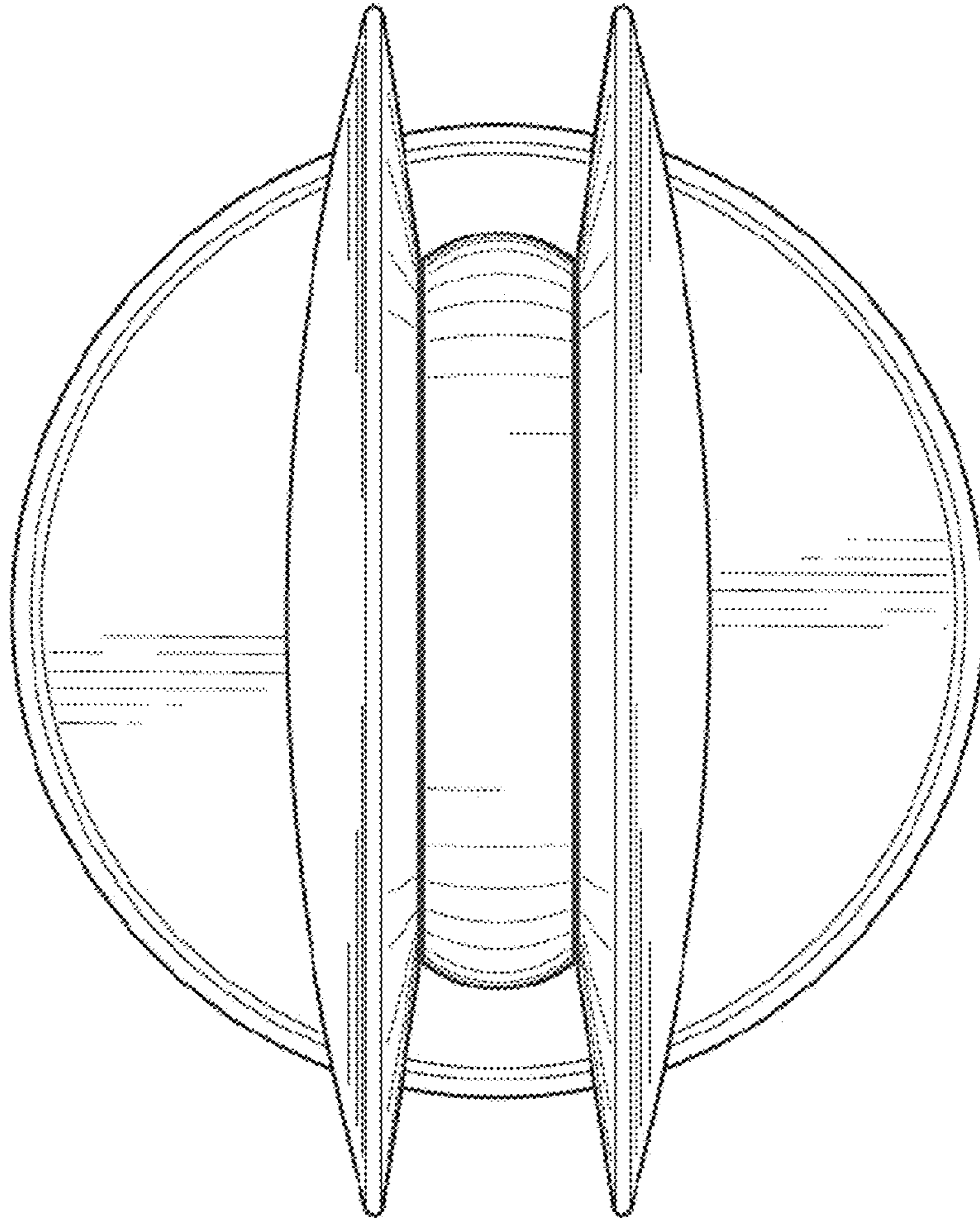

Fig. 6

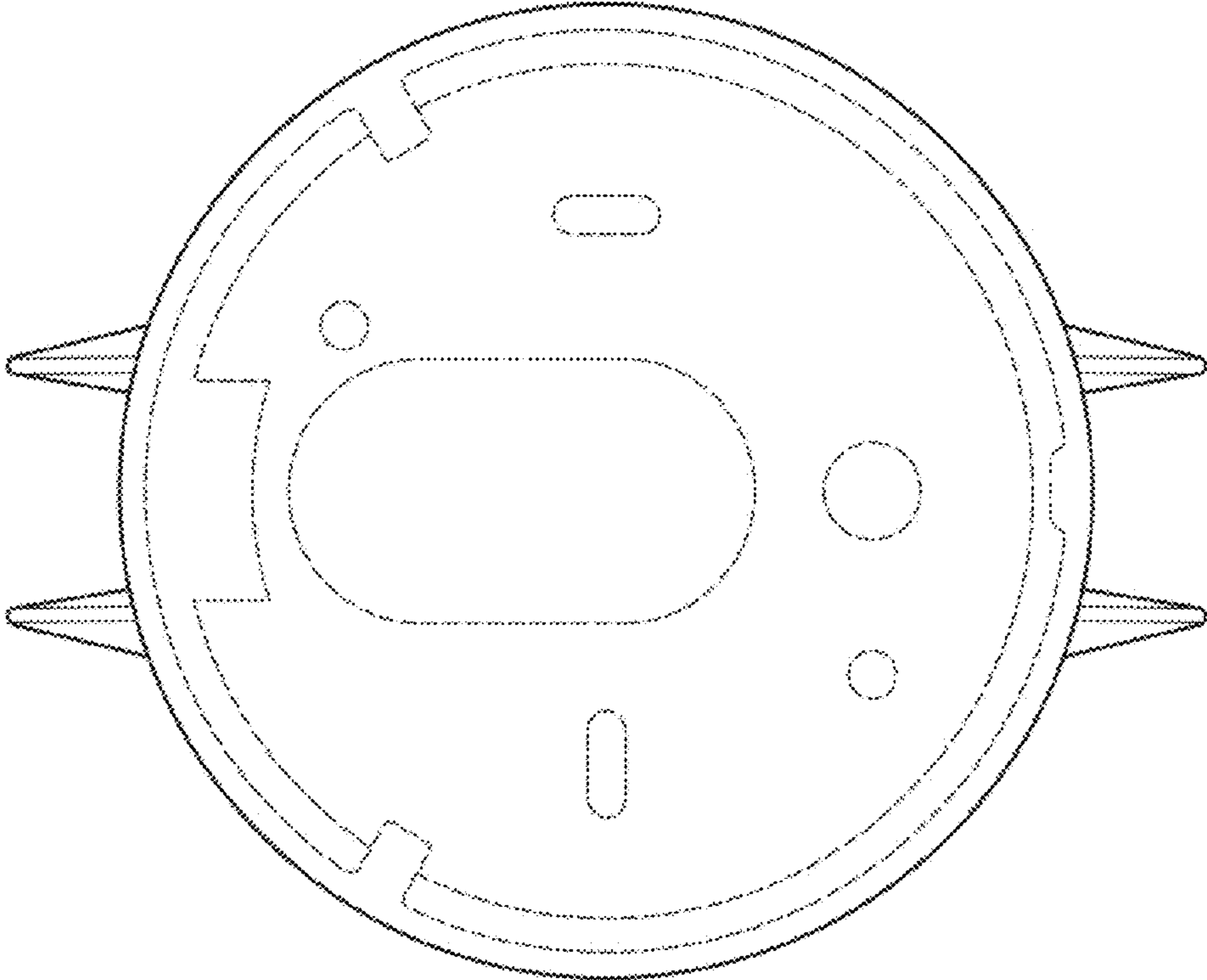

Fig. 7