



US00D767718S

(12) **United States Design Patent** (10) **Patent No.:** **US D767,718 S**  
**Lampman** (45) **Date of Patent:** **\*\* Sep. 27, 2016**

(54) **AIRBRUSH GRIP**

FOREIGN PATENT DOCUMENTS

(71) Applicant: **George Robert Lampman**, North Hollywood, CA (US)

JP 2002073010 A 3/2002

*Primary Examiner* — Robin V Webster

(72) Inventor: **George Robert Lampman**, North Hollywood, CA (US)

(74) *Attorney, Agent, or Firm* — Browdy and Neimark, PLLC

(\*\*) Term: **15 Years**

(57) **CLAIM**

The ornamental design for an airbrush grip, as shown and described.

(21) Appl. No.: **29/530,496**

(22) Filed: **Jun. 17, 2015**

**DESCRIPTION**

(51) **LOC (10) Cl.** ..... **23-01**

(52) **U.S. Cl.**

USPC ..... **D23/223**

(58) **Field of Classification Search**

USPC ..... D23/213, 223, 22; D19/108; 239/526, 239/290, 291

CPC ..... B05B 1/005; B05B 9/01

See application file for complete search history.

(56) **References Cited**

U.S. PATENT DOCUMENTS

445,192 A	1/1891	Nye et al.	
D123,203 S *	10/1940	Potter	D23/226
D140,837 S *	4/1945	Baur	D23/226
3,825,004 A	7/1974	Durden	
D247,506 S *	3/1978	Bass	D23/226
4,079,893 A	3/1978	Bass	
D248,041 S *	5/1978	Persson	D23/226
4,161,289 A	7/1979	Rebold	
4,197,611 A	4/1980	Bell et al.	
4,526,547 A	7/1985	Rusk	
4,890,355 A	1/1990	Schulten	
5,088,903 A *	2/1992	Tomatsu	B05B 7/12 239/526
5,421,518 A	6/1995	Robisch et al.	
5,492,425 A	2/1996	Carter et al.	
5,779,157 A	7/1998	Robisch et al.	
5,840,122 A	11/1998	Williams	
5,927,602 A	7/1999	Robisch et al.	
6,155,354 A	12/2000	Pusateri et al.	

(Continued)

FIG. 1 is a perspective view of an airbrush grip according to the present design, assembled to an air brush and viewed from the front and above;

FIG. 2 is a front view of the airbrush grip of FIG. 1;

FIG. 3 is a rear view of the airbrush grip of FIG. 1;

FIG. 4 is a right side view of the airbrush grip of FIG. 1;

FIG. 5 is a left side view of the airbrush grip of FIG. 1;

FIG. 6 is a top view of the airbrush grip of FIG. 1; and

FIG. 7 is a bottom view of the airbrush grip of FIG. 1;

FIG. 8 is a top view of the airbrush grip disassembled from the airbrush;

FIG. 9 is a left side view of the airbrush grip disassembled from the airbrush;

FIG. 10 is a rear view of the airbrush grip disassembled from the airbrush;

FIG. 11 is a perspective view of the airbrush grip disassembled from the airbrush and viewed from the front and above;

FIG. 12 is a perspective view of the airbrush grip disassembled from the airbrush and viewed from the rear and above; and,

FIG. 13 is a perspective view of the airbrush grip disassembled from the airbrush and viewed from the front and below.

In FIGS. 1-7 the airbrush is shown in broken lines and forms no part of the claimed design.

**1 Claim, 11 Drawing Sheets**

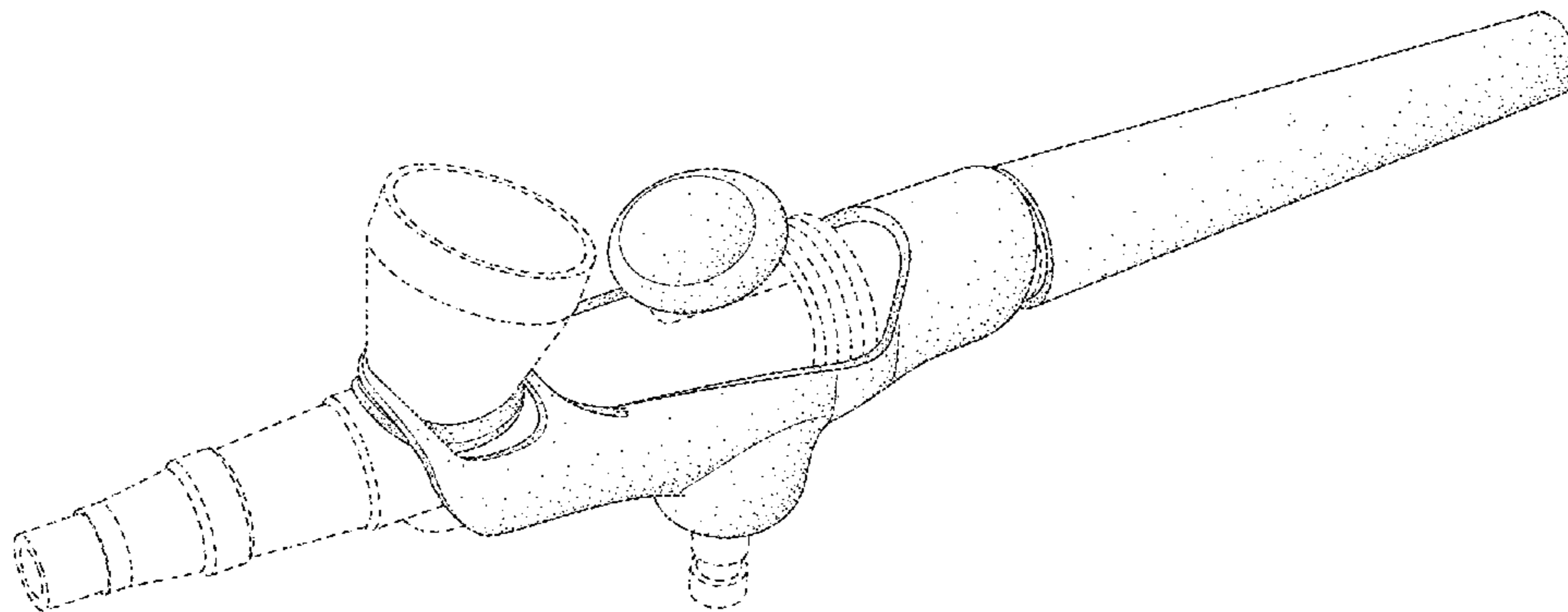

(56)

References Cited

U.S. PATENT DOCUMENTS

6,192,774 B1	2/2001	Bauer et al.	7,070,124 B1	7/2006	Juo	
6,273,626 B1	8/2001	Yazawa	7,128,656 B1	10/2006	Orchel	
6,315,476 B2	11/2001	Nakagawa	7,306,390 B2	12/2007	Quintero	
6,345,517 B1	2/2002	Jahnke	7,409,791 B2	8/2008	Moody et al.	
6,399,913 B1	6/2002	Sammons et al.	7,572,198 B2	8/2009	Bleecker	
6,439,791 B1	8/2002	Takeuchi et al.	7,770,262 B2	8/2010	Schultz et al.	
6,779,742 B2 *	8/2004	Kitajima ..... B05B 7/1209 137/626	7,896,191 B1	3/2011	Fall et al.	
6,892,960 B2	5/2005	Ptak et al.	8,366,023 B1 *	2/2013	Lin ..... B05B 9/0872 222/333	
6,976,640 B2 *	12/2005	Chen ..... B05B 1/005 239/290	8,602,925 B1	12/2013	Rickon, Jr.	
			2003/0071144 A1	4/2003	Naemura	
			2011/0185617 A1	8/2011	Brixius	
			2011/0222952 A1	9/2011	Gueret	
			2013/0219666 A1	8/2013	Wong	

\* cited by examiner

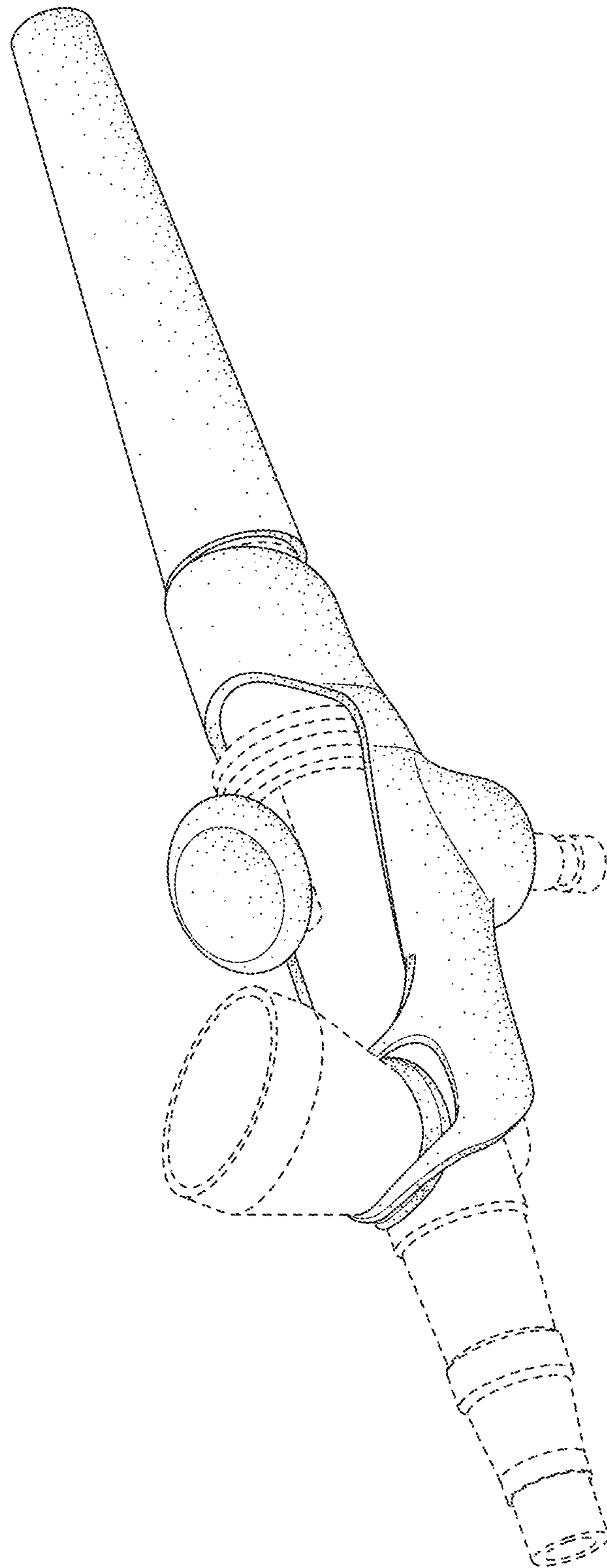

FIG. 1

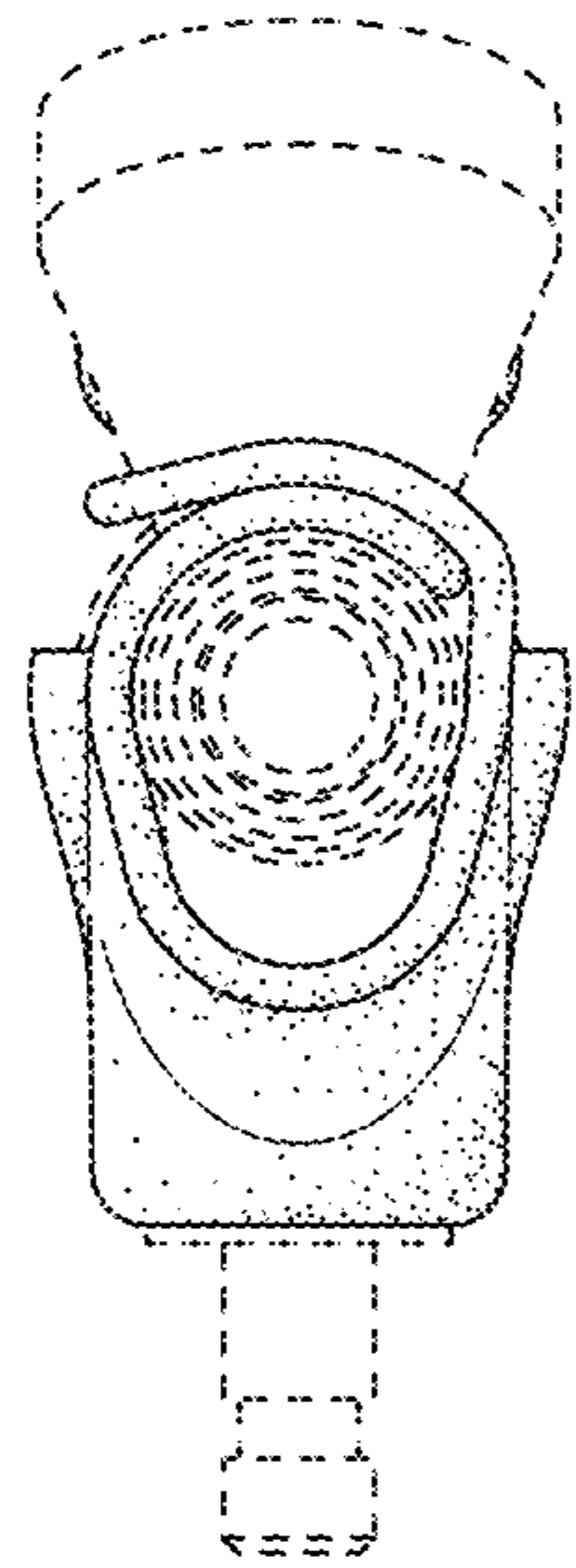

FIG. 2

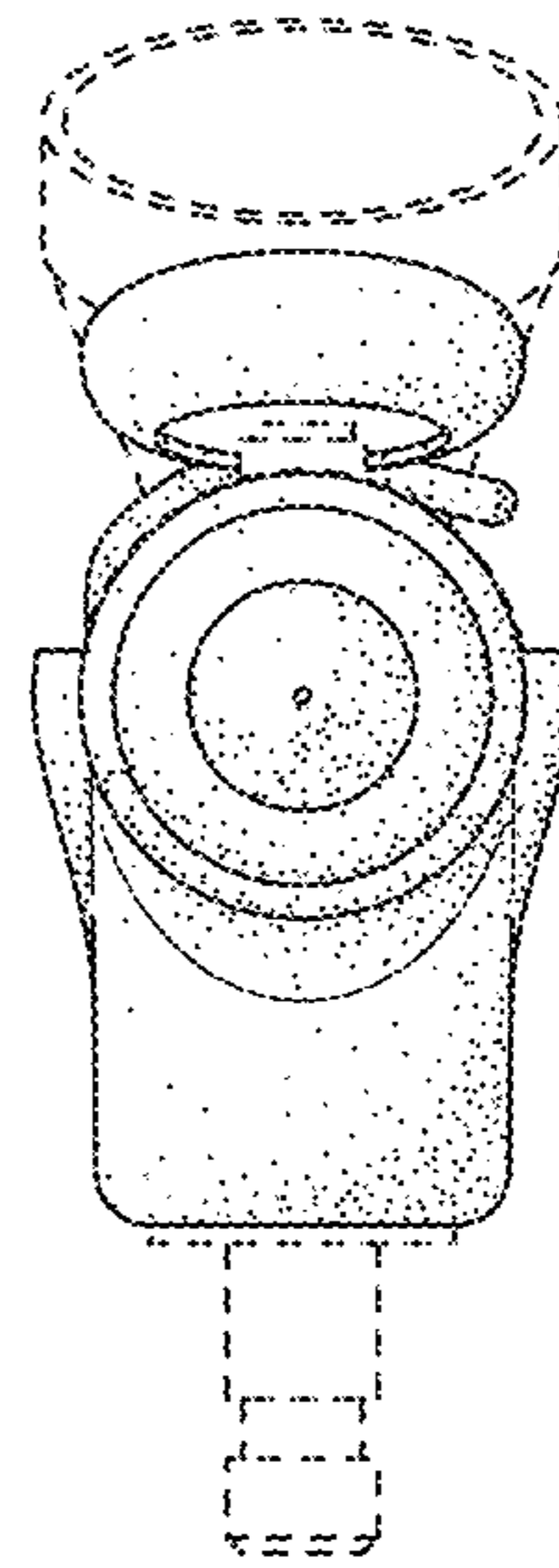

FIG. 3

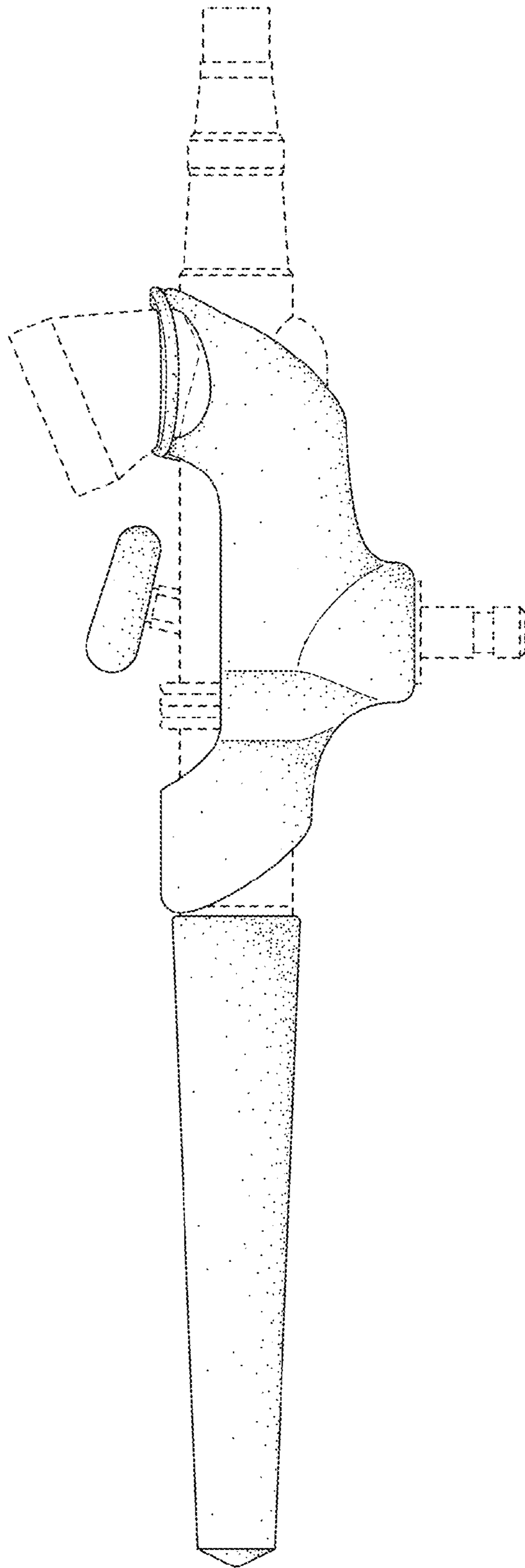

FIG. 4

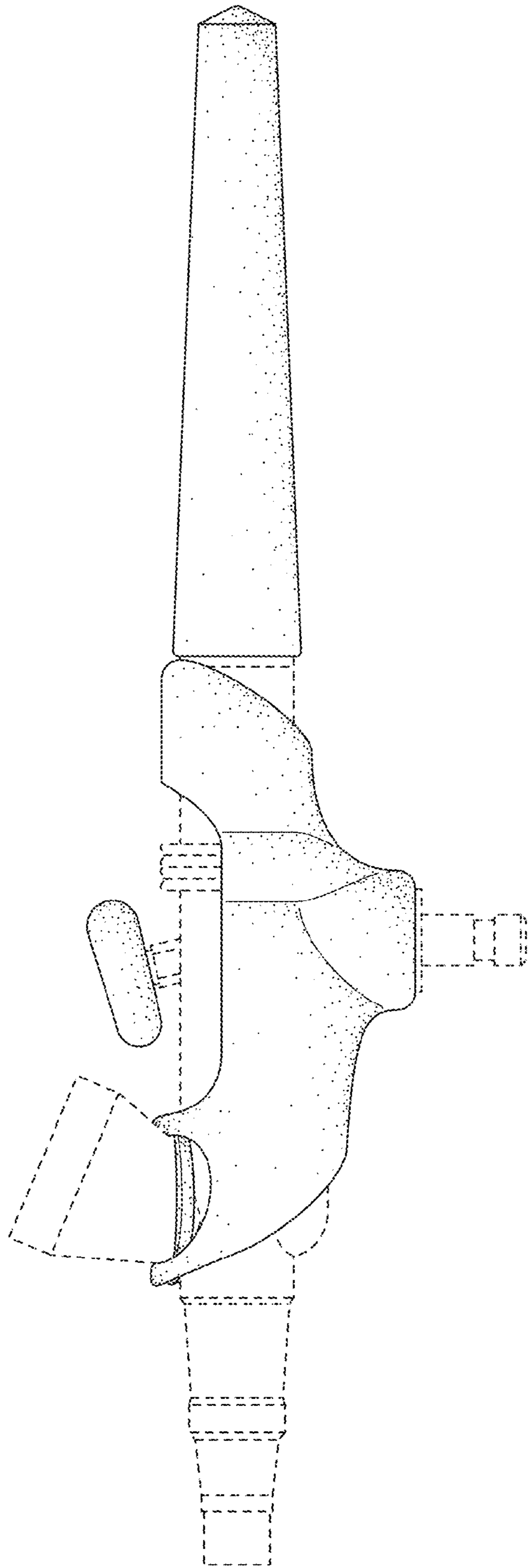

FIG. 5

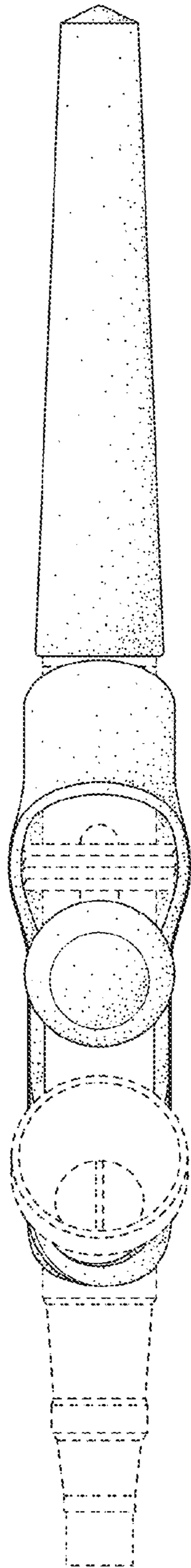

FIG. 6

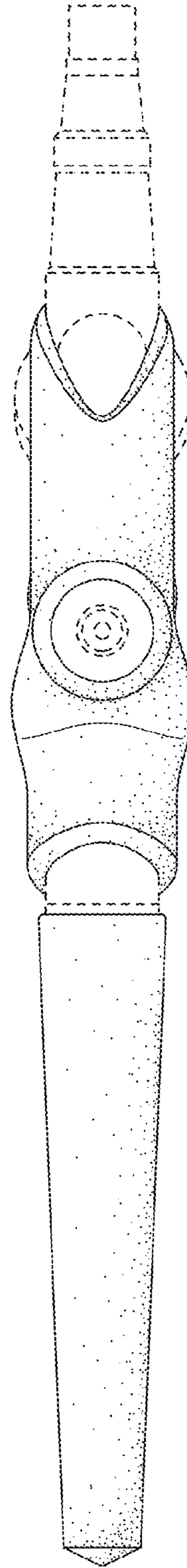

FIG. 7

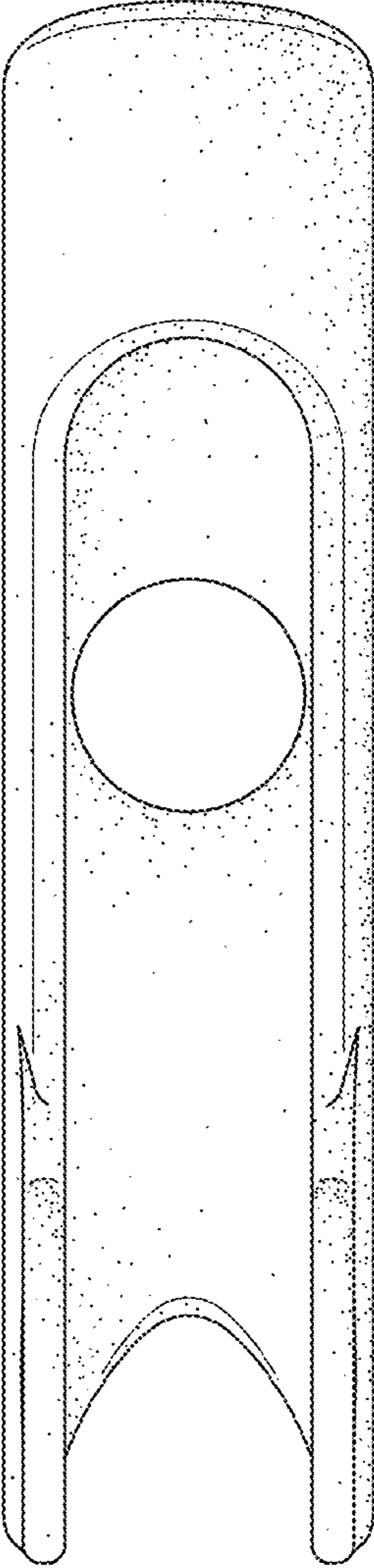

FIG. 8



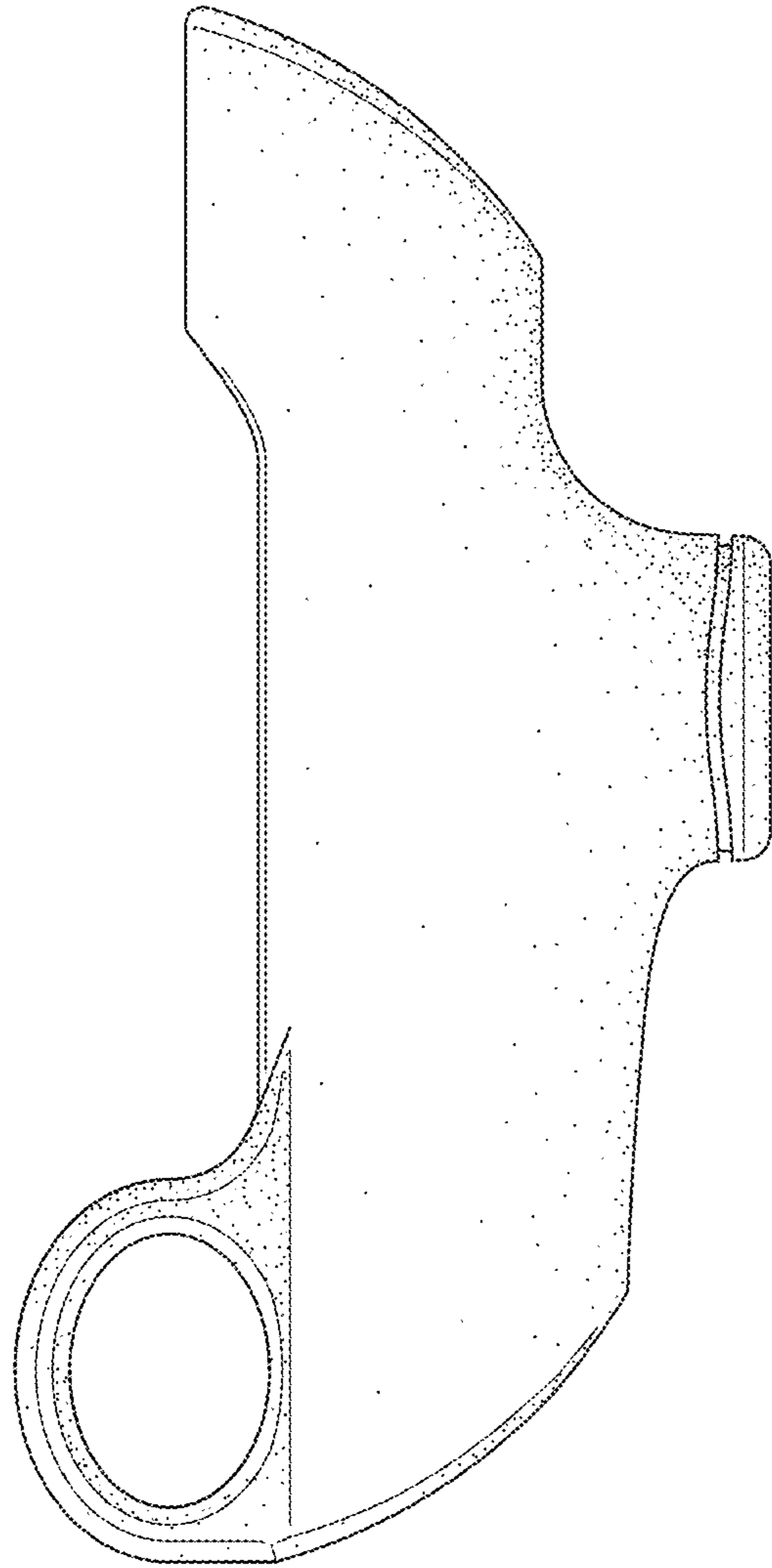

FIG. 9

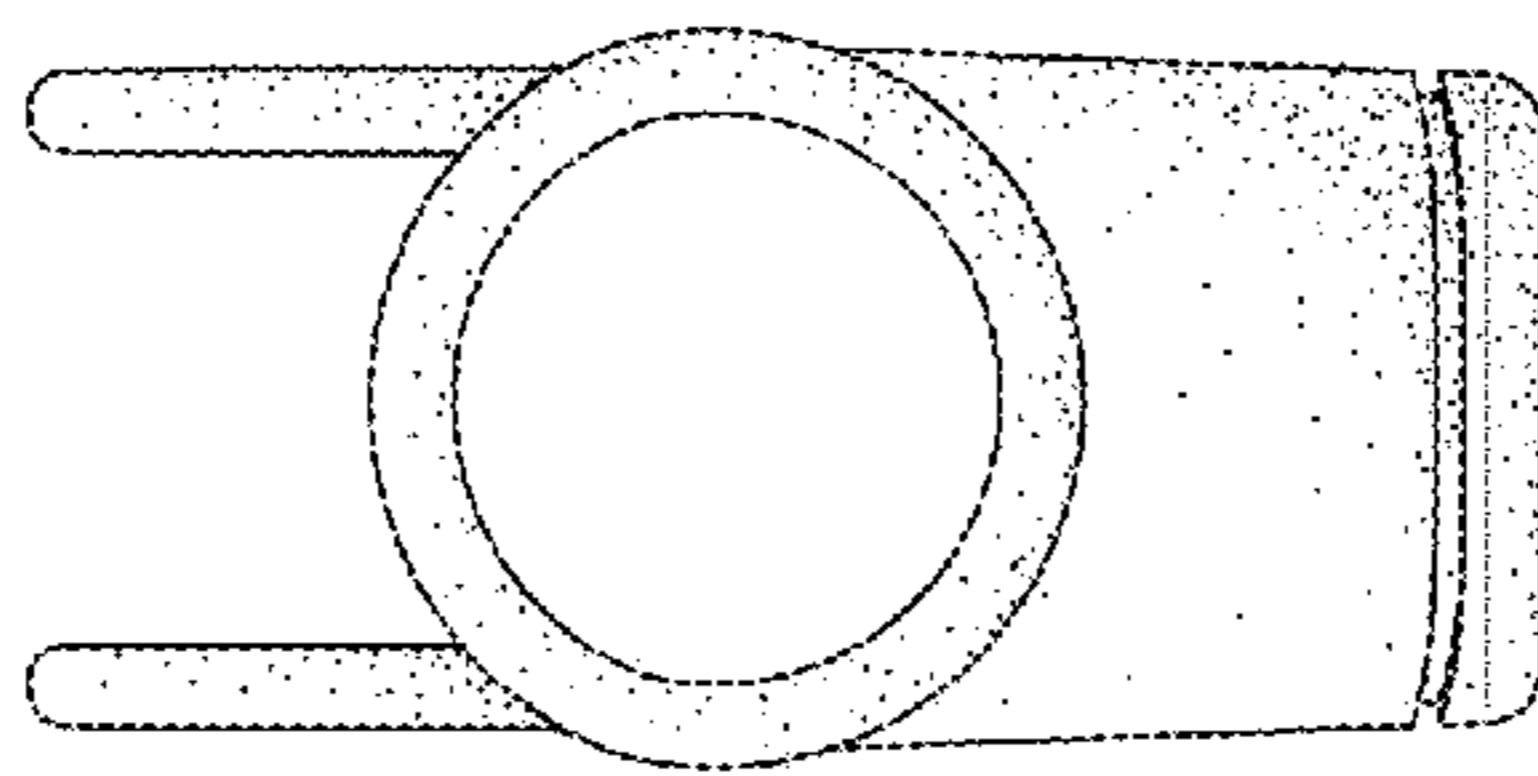

FIG. 10

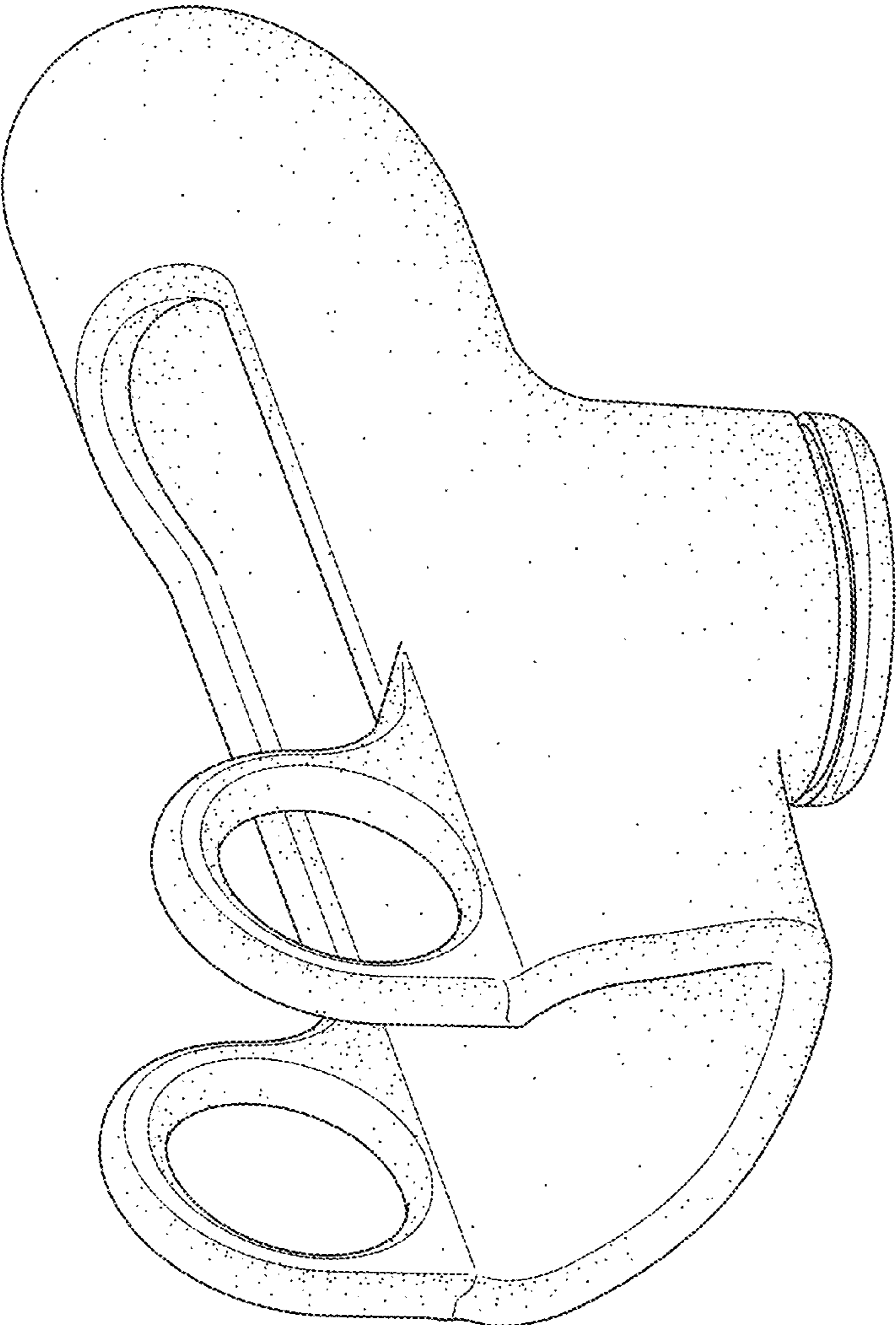

FIG. 11

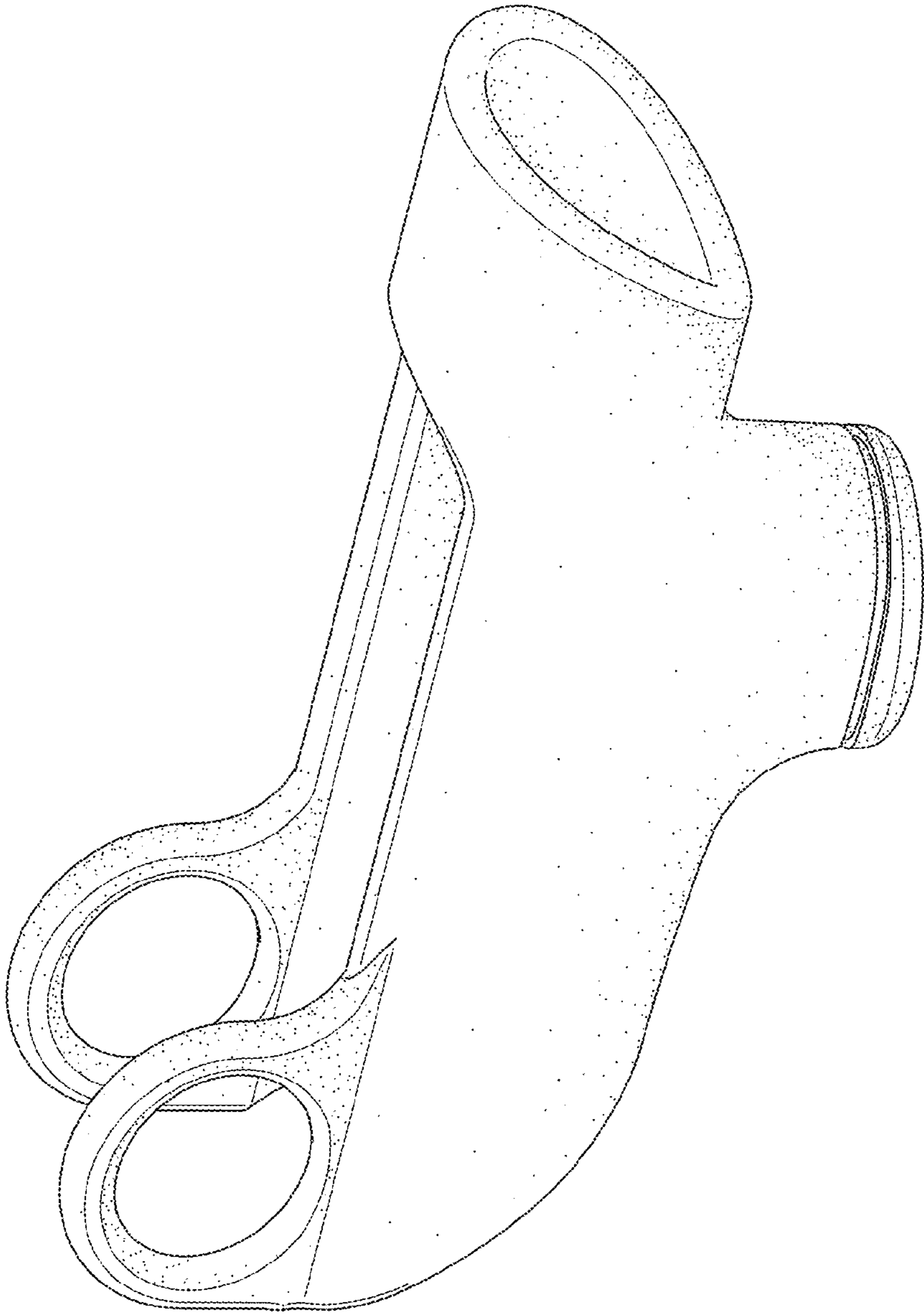

FIG. 12

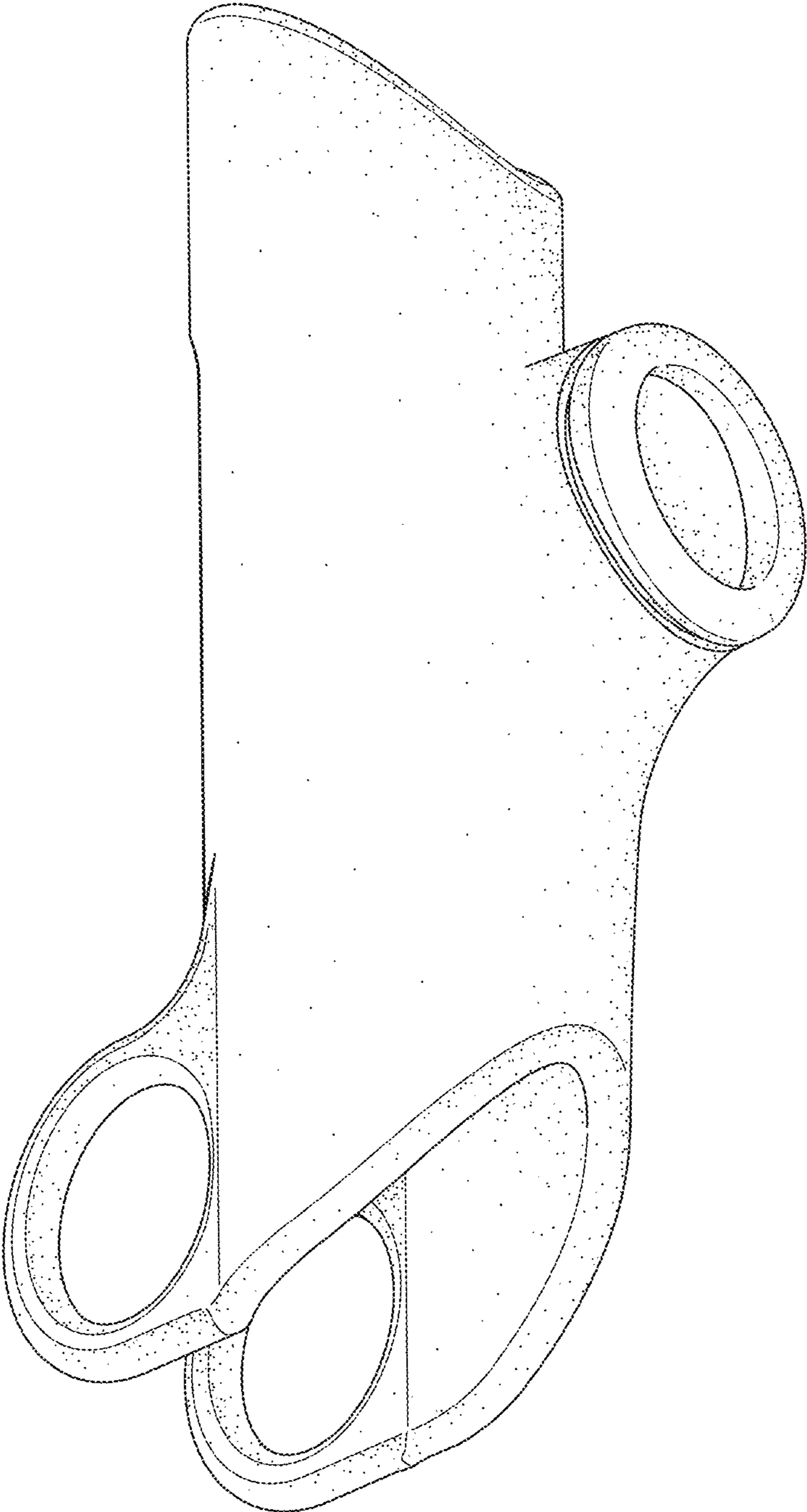

FIG. 13