

US00D767640S

(12) **United States Design Patent**  
**Major et al.**

(10) **Patent No.:** **US D767,640 S**  
(45) **Date of Patent:** **\*\* Sep. 27, 2016**

(54) **GRASS CATCHER BAG INSERT WITH SNAPS**

6,151,875 A	11/2000	Collins	
6,176,455 B1	1/2001	Ma	
D489,768 S *	5/2004	Babineaux	..... D15/17
7,806,593 B2 *	10/2010	Toporski	..... A01D 43/063
			383/1
2007/0071365 A1 *	3/2007	Stevens	..... A01D 43/063
			383/33
2008/0083204 A1 *	4/2008	Vineis	..... A01D 43/063
			56/202

(71) Applicants: **Stanley K. Major**, Kingfisher, OK (US); **Deborah L. Major**, Kingfisher, OK (US)

(72) Inventors: **Stanley K. Major**, Kingfisher, OK (US); **Deborah L. Major**, Kingfisher, OK (US)

(\*\*) Term: **15 Years**

(21) Appl. No.: **29/533,479**

(22) Filed: **Jul. 17, 2015**

(51) **LOC (10) Cl.** ..... **15-03**

(52) **U.S. Cl.**  
USPC ..... **D15/17**

(58) **Field of Classification Search**  
USPC ..... D15/10, 14, 17, 28, 199; D34/1-11  
CPC ..... A01D 34/733; A01D 34/81; A01D 34/4166; A01D 34/74; A01D 34/84; A01D 43/063; A01D 34/71; A01D 34/73; A01D 34/828; A01D 34/4163; A01D 34/82; A01D 69/02; A01D 34/005; A01D 34/68; A01D 34/685; A01D 34/824; A01D 43/0636  
See application file for complete search history.

(56) **References Cited**

**U.S. PATENT DOCUMENTS**

3,492,800 A *	2/1970	Peterson	..... A01D 43/063	15/83
3,777,461 A *	12/1973	Giraud	..... A01D 43/063	56/202
D267,646 S *	1/1983	McCarron	..... D15/28	
4,377,063 A	3/1983	Leaphart		
4,989,400 A	2/1991	Wark		
5,042,241 A	8/1991	Boylston et al.		
5,213,141 A *	5/1993	Dorman	..... B65F 1/0006	141/10
5,564,265 A	10/1996	Pitt		

\* cited by examiner

*Primary Examiner* — Ian Simmons

*Assistant Examiner* — Khawaja Anwar

(74) *Attorney, Agent, or Firm* — Robert C. Montgomery; Montgomery Patent & Design

(57) **CLAIM**

The ornamental design for a grass catcher bag insert with snaps, as shown and described.

**DESCRIPTION**

FIG. 1 is a top perspective exploded view of the grass catcher bag insert with snaps, showing our new design; FIG. 2 is a top plan view of the grass catcher bag insert, shown without the snaps; FIG. 3 is a bottom plan view thereof; FIG. 4 is a right side elevation view thereof, the left side elevation view being a mirror image thereto; FIG. 5 is a front side elevation view thereof, the backside elevation view being a mirror image thereto; FIG. 6 is a top plan view of an individual snap shown without the seven additional snaps and the grass catcher bag insert; FIG. 7 is a right side elevation view thereof, the left side elevation view being a mirror image thereto; FIG. 8 is a bottom plan view thereof; FIG. 9 is a front side elevation view thereof; and, FIG. 10 is a back side elevation view thereof. The broken lines indicate boundary areas and form no part of the claimed design.

**1 Claim, 6 Drawing Sheets**

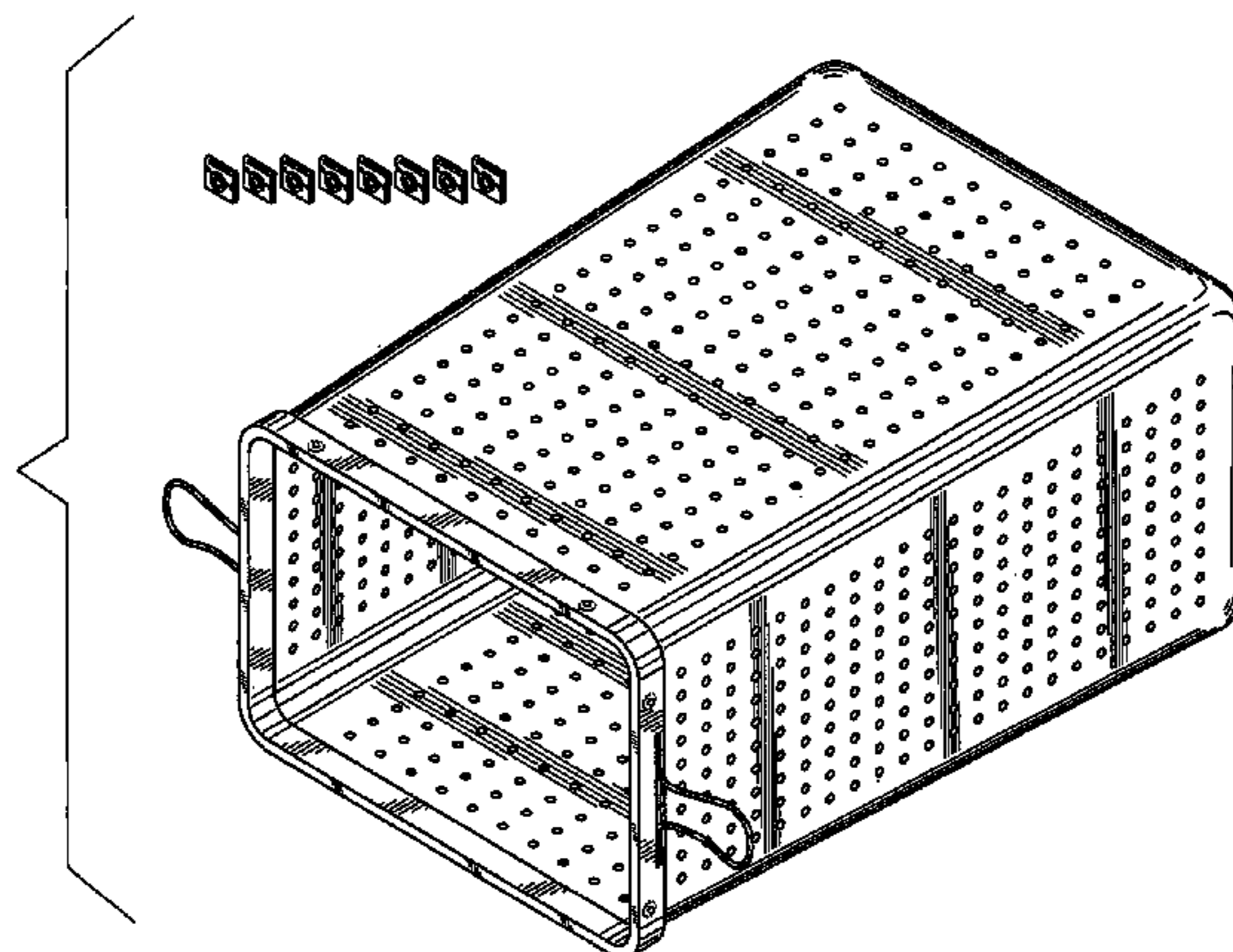

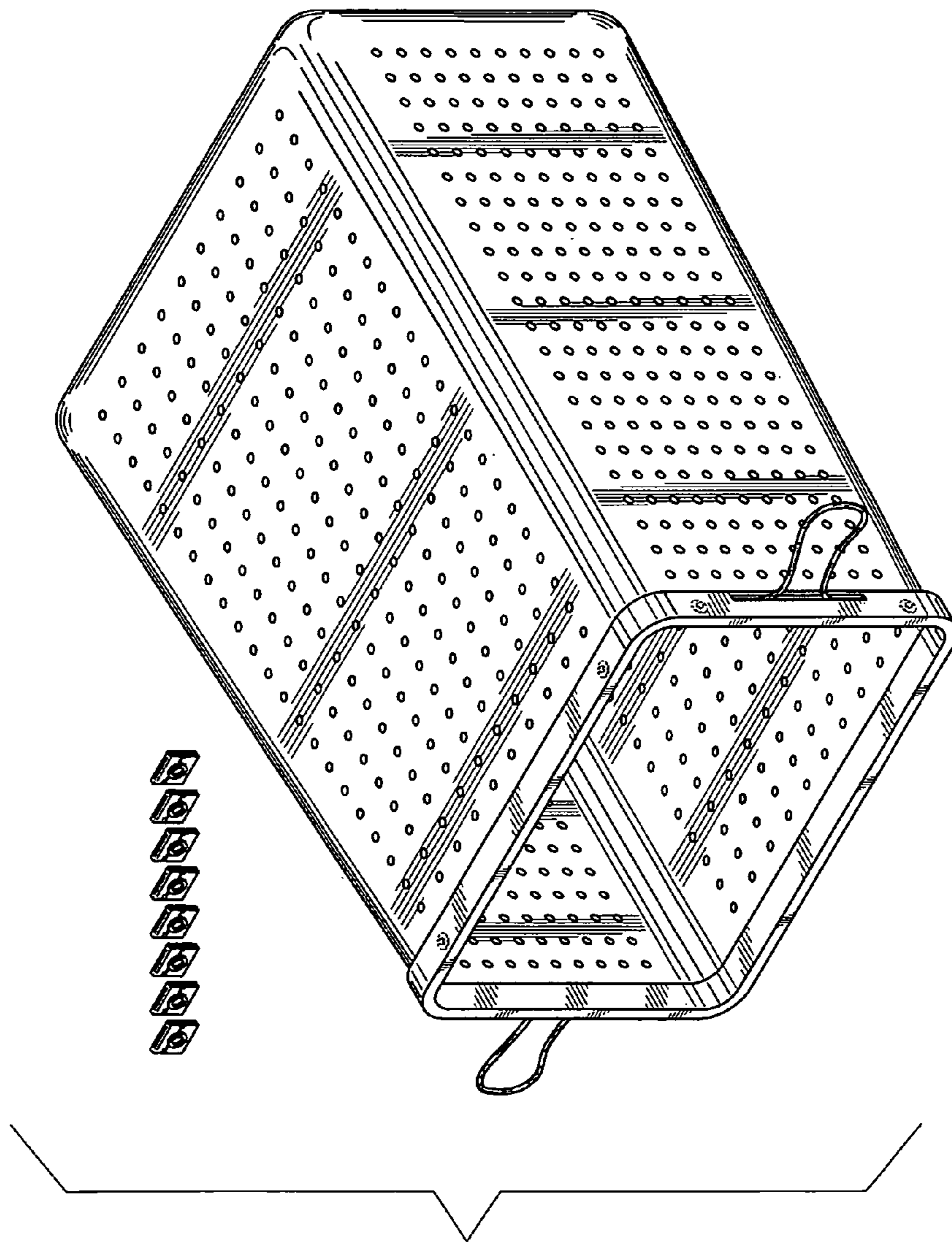

FIG. 1

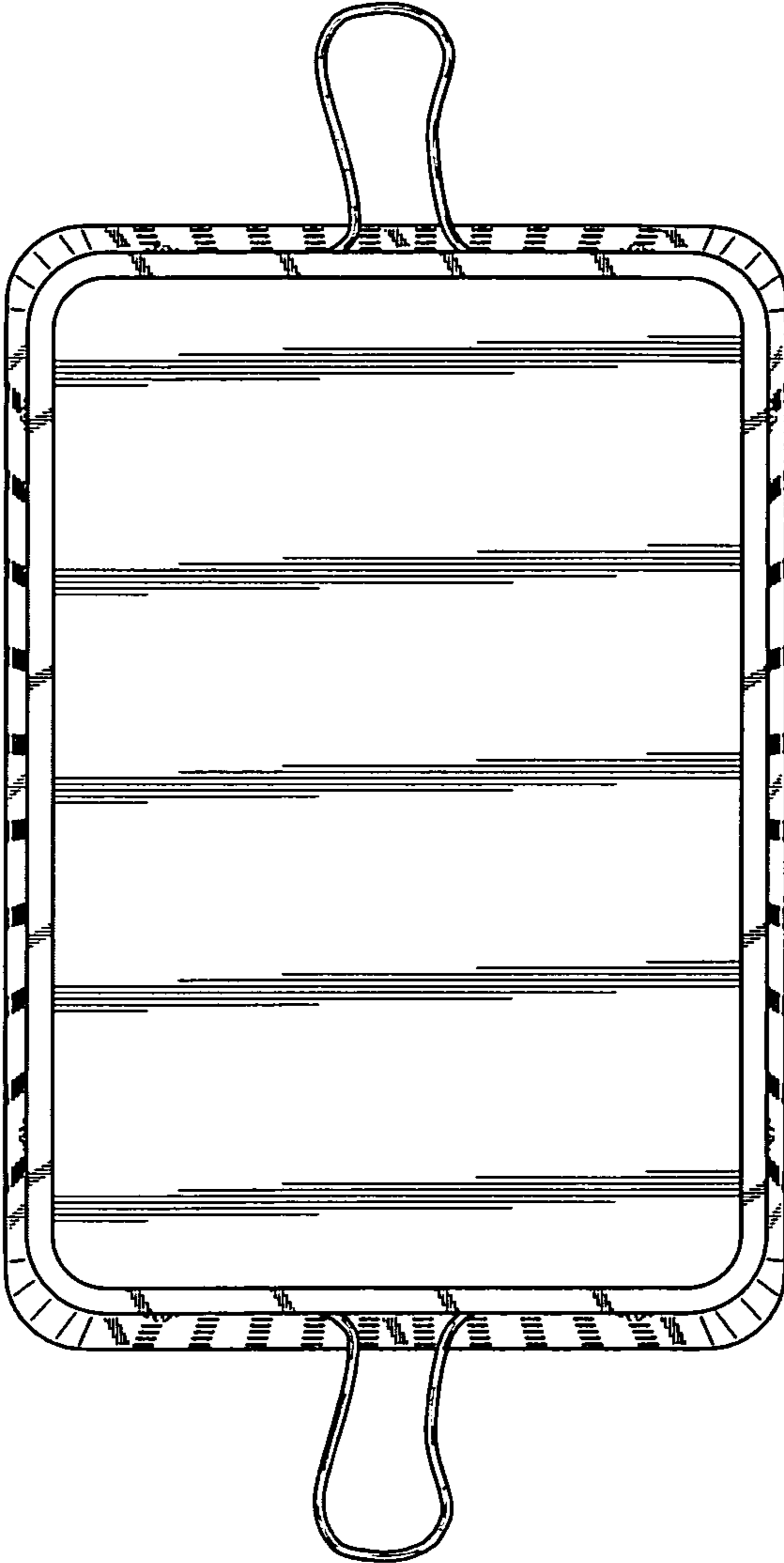

FIG. 2

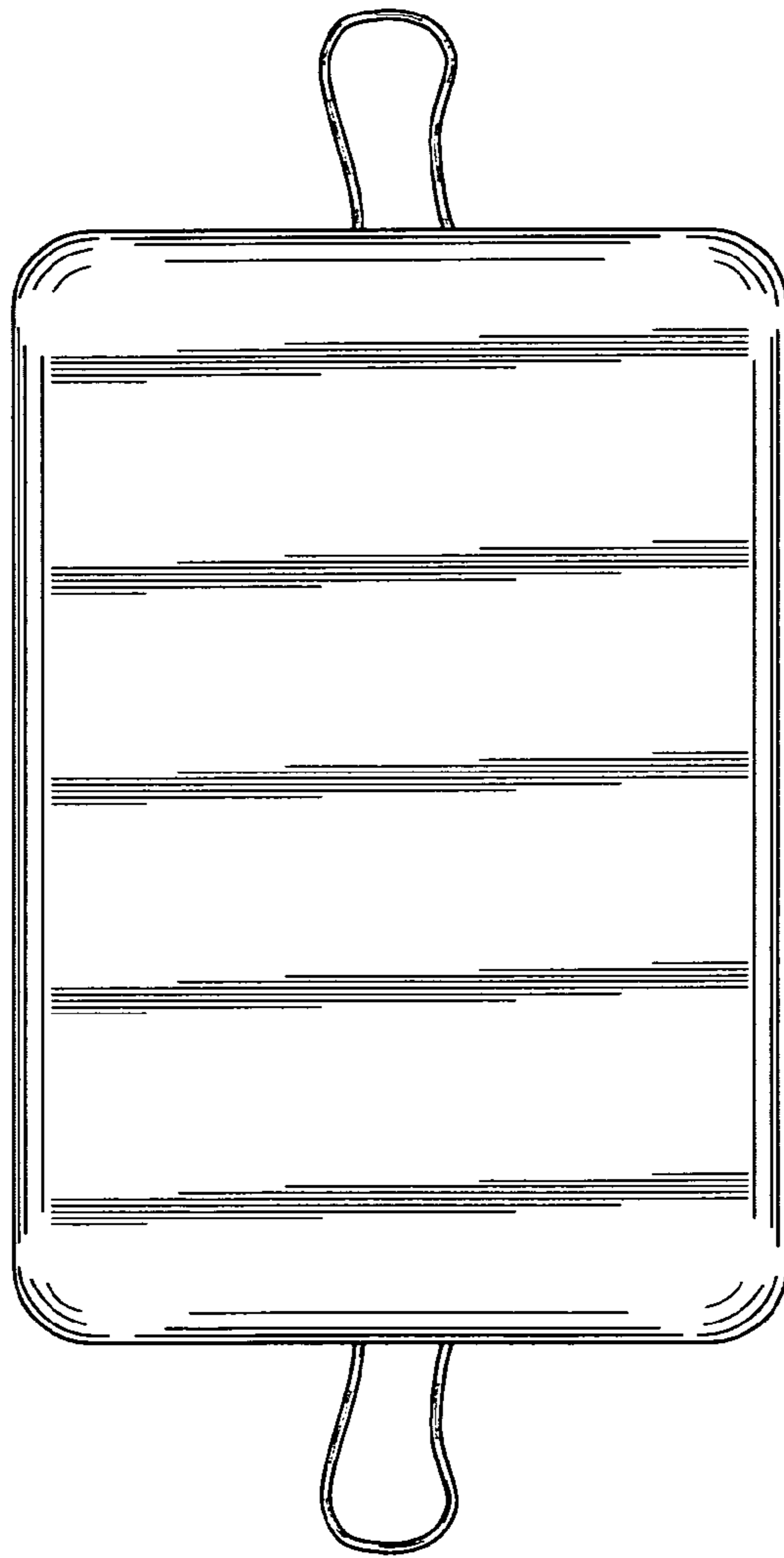

FIG. 3

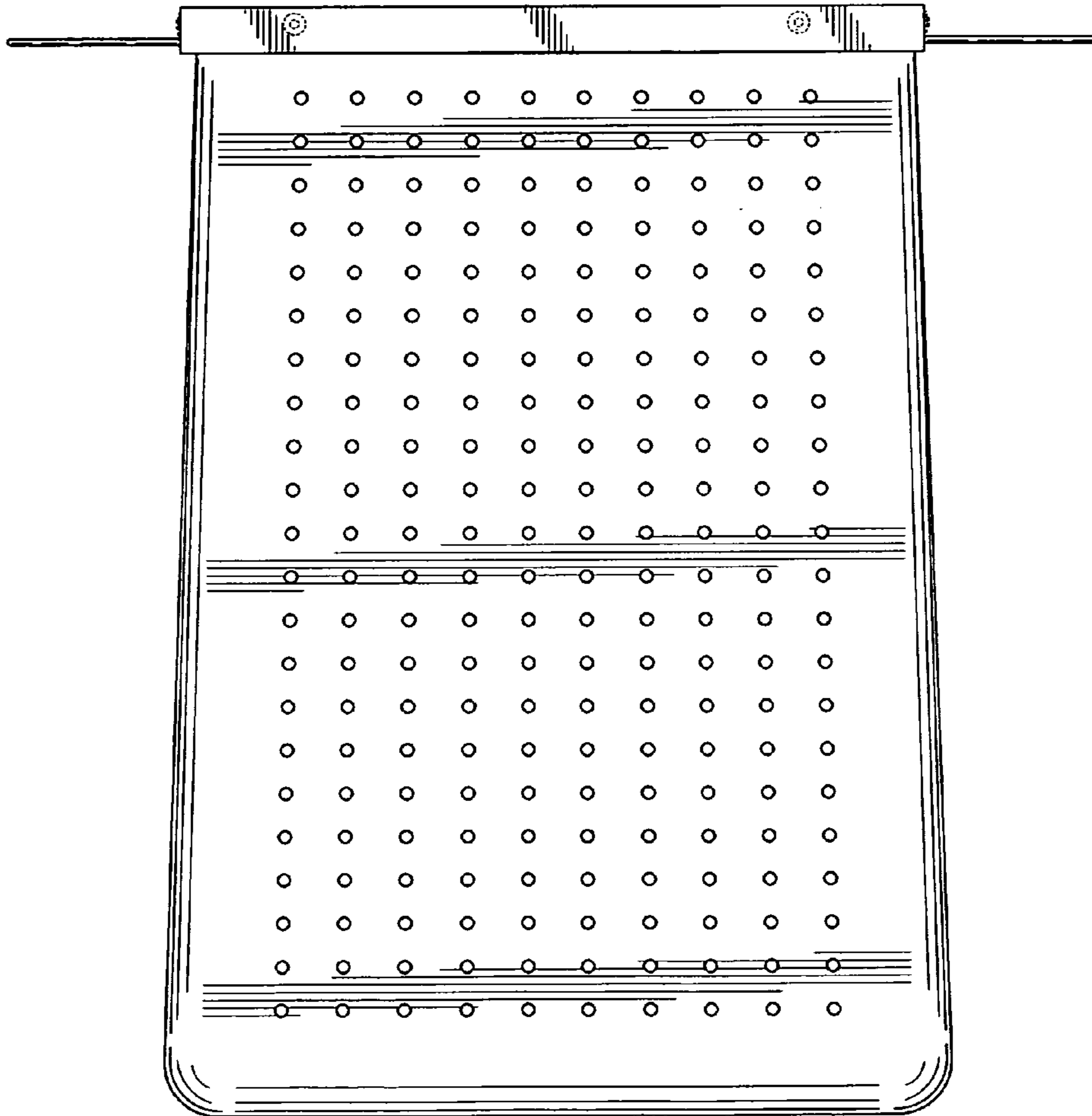

FIG. 4

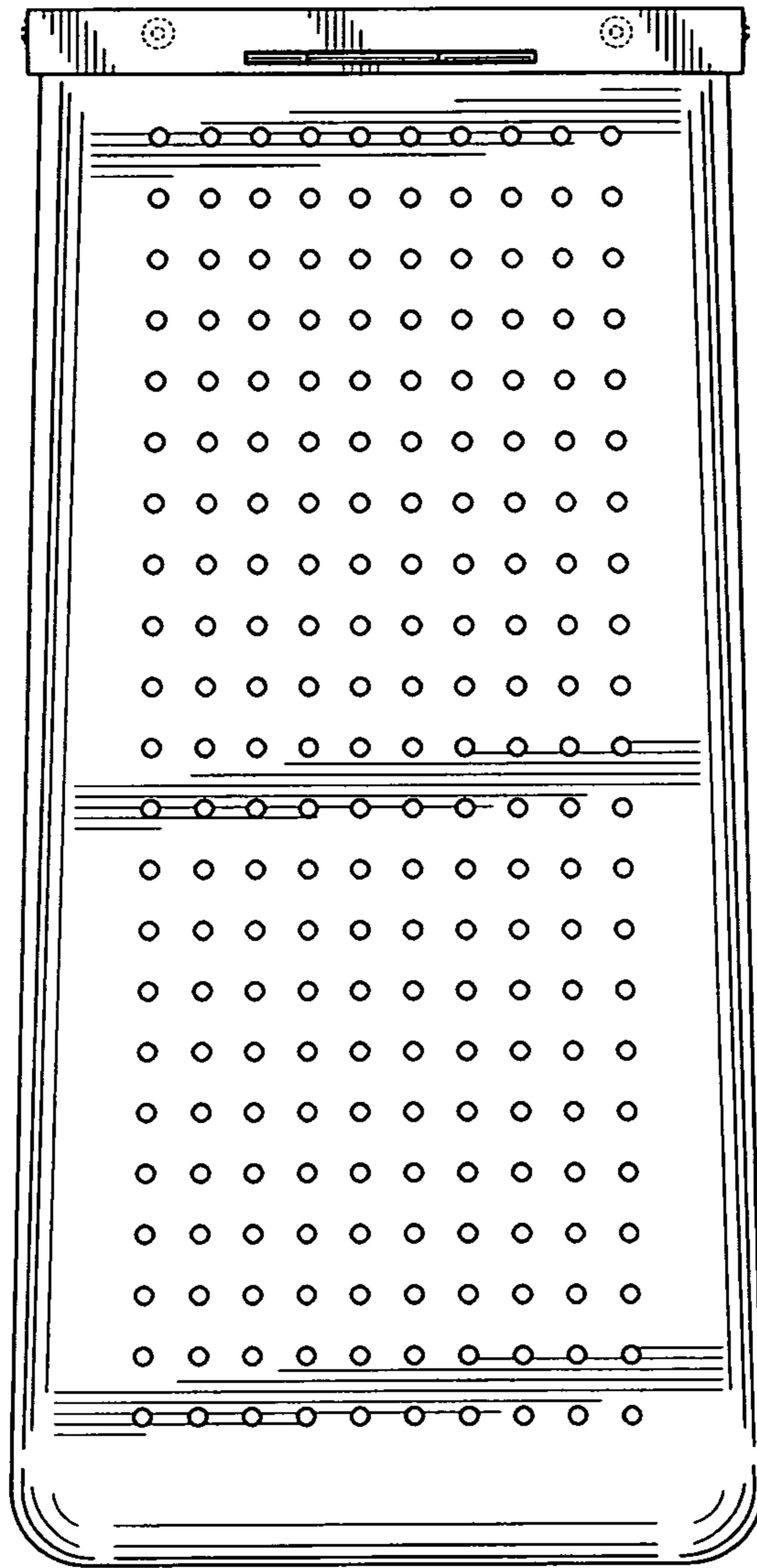

FIG. 5

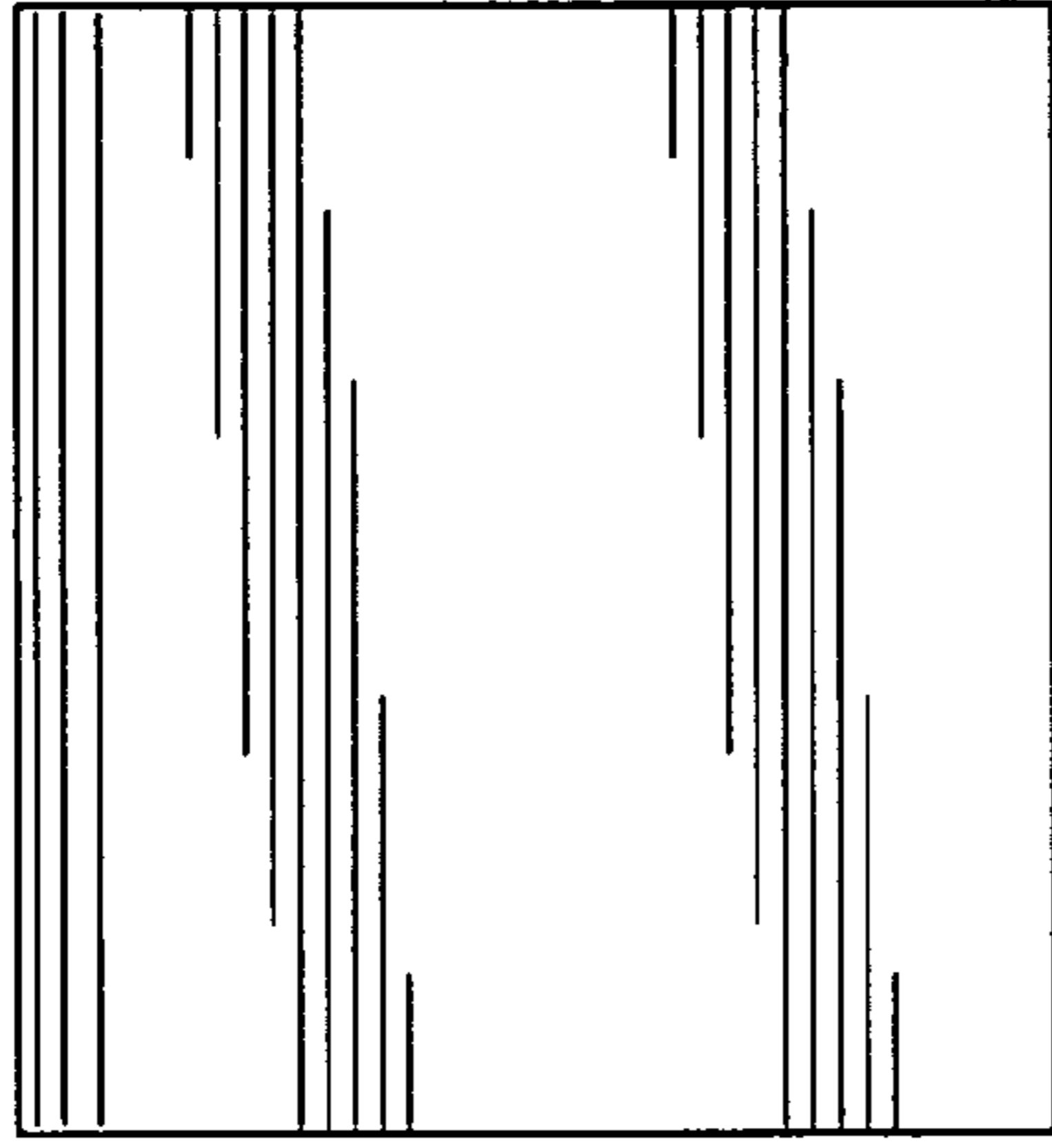

FIG. 6

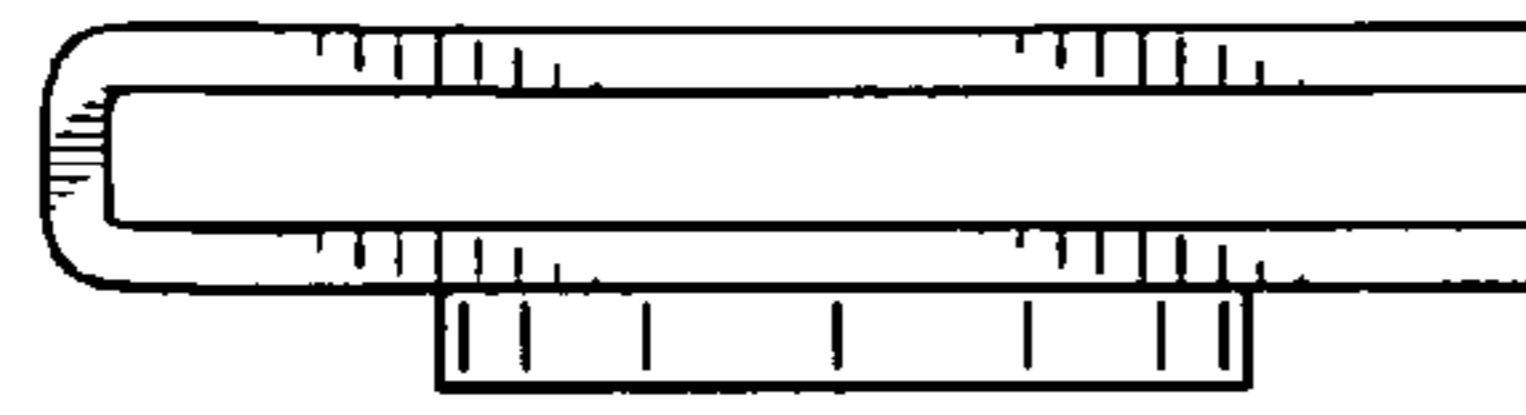

FIG. 7

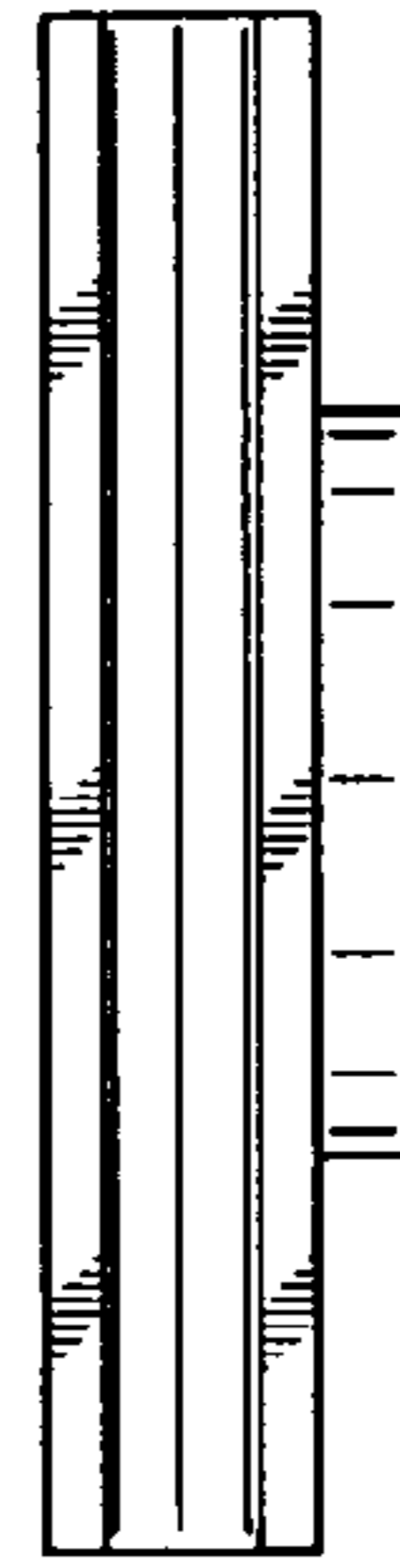

FIG. 8



FIG. 9

FIG. 10