



US00D767509S

(12) **United States Design Patent**
Lavin, Jr.

(10) **Patent No.:** **US D767,509 S**

(45) **Date of Patent:** **** Sep. 27, 2016**

(54) **CONTROLLER DEVICE FOR HEATING KIT**

(71) Applicant: **Edwin F. Lavin, Jr.**, Houston, TX (US)

(72) Inventor: **Edwin F. Lavin, Jr.**, Houston, TX (US)

(73) Assignee: **My Core Control Development, LLC**,
Houston, TX (US)

(**) Term: **14 Years**

(21) Appl. No.: **29/515,123**

(22) Filed: **Jan. 20, 2015**

(51) **LOC (10) Cl.** **14-03**

(52) **U.S. Cl.**
USPC **D13/168**

(58) **Field of Classification Search**
USPC D13/168; D10/104.1; D14/191, 192,
D14/218; 219/211

CPC A41D 13/005; A41D 13/0051; H05B
1/0272; H05B 3/34; H05B 3/342; H05B
2203/036

See application file for complete search history.

(56) **References Cited**

U.S. PATENT DOCUMENTS

D430,854 S *	9/2000	Vende	D13/168
D486,144 S *	2/2004	Esslinger	D14/218
D533,514 S *	12/2006	Hidalgo	D13/168
D568,827 S *	5/2008	Ikeda	D13/168
D570,793 S *	6/2008	Ikeda	D13/168
D571,305 S *	6/2008	Thursfield	D13/168
D571,737 S *	6/2008	Koury	D13/168
D578,079 S *	10/2008	Huang	D13/168
D581,370 S *	11/2008	Corsini	D13/168
D584,696 S *	1/2009	Howman	D13/168
D593,509 S *	6/2009	Glassman	D13/168
D595,670 S *	7/2009	Glassman	D13/168
D595,671 S *	7/2009	Glassman	D13/168
D597,038 S *	7/2009	Glassman	D13/168
D602,916 S *	10/2009	Won	D14/218
D605,177 S *	12/2009	Madonna	D14/218

D619,545 S *	7/2010	Chiu	D13/168
D645,848 S *	9/2011	Arnholt	D14/218
D688,232 S *	8/2013	Zhang	D14/218
D693,332 S *	11/2013	Lee	D13/168
D710,828 S *	8/2014	Liu	D14/218
D728,530 S *	5/2015	Shin	D14/218
D729,209 S *	5/2015	McManigal	D14/218
D731,469 S *	6/2015	Turksu	D14/218
D743,944 S *	11/2015	Karrman	D14/218
9,176,578 B2 *	11/2015	Nomura	G06F 3/01
D746,266 S *	12/2015	Kwon	D14/218
9,235,273 B2 *	1/2016	Opran	G06F 3/0202
D750,047 S *	2/2016	Chang	D14/218
D752,025 S *	3/2016	Akana	D14/218
D752,555 S *	3/2016	Langhammer	D14/218
D752,556 S *	3/2016	Eriksen	D14/218
9,298,255 B2 *	3/2016	Kimura	G06F 3/01
2010/0238640 A1 *	9/2010	Yang	H04M 1/236 361/811

(Continued)

Primary Examiner — Selina Sikder

(74) *Attorney, Agent, or Firm* — Winstead PC

(57) **CLAIM**

I claim the ornamental design for a controller device for a heating kit, as shown and described.

DESCRIPTION

This application claims the benefit of the U.S. Design patent application Ser. No. 29/515,053, filed on Jan. 20, 2015, which is incorporated herein by reference.

FIG. 1 shows a top view of a controller device for a heating kit;

FIG. 2 shows a bottom view of the controller device;

FIG. 3 shows a left side view the controller device;

FIG. 4 shows a right side view the controller device;

FIG. 5 shows a front view the controller device; and,

FIG. 6 shows a rear view the controller device.

The dashed lines are for the purpose of illustrating portions of the controller device and form no part of the claimed design. The dotted lines on the surface portions indicate contour and not surface decoration.

1 Claim, 3 Drawing Sheets

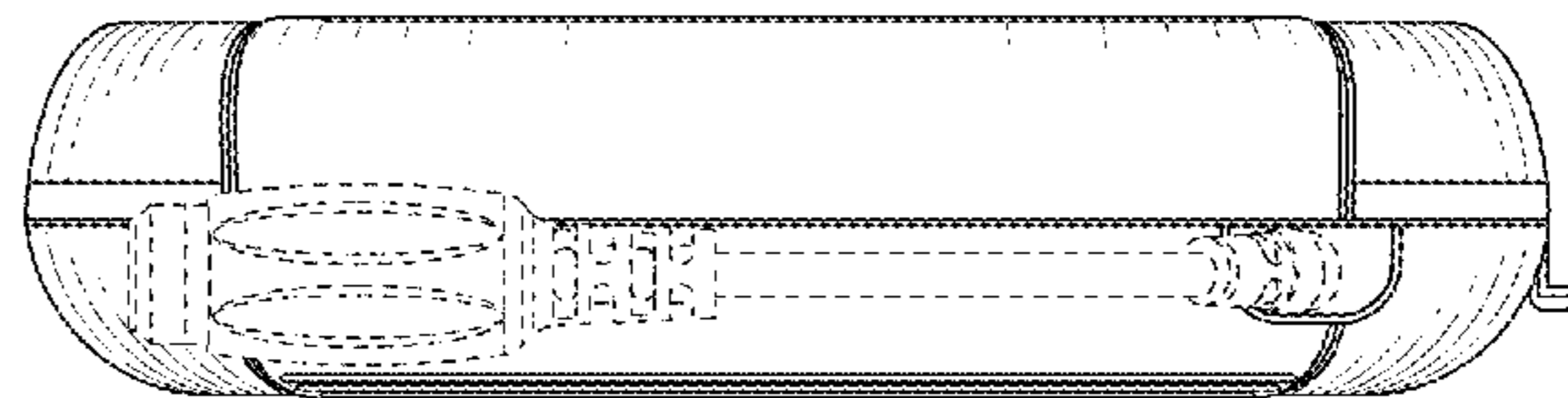
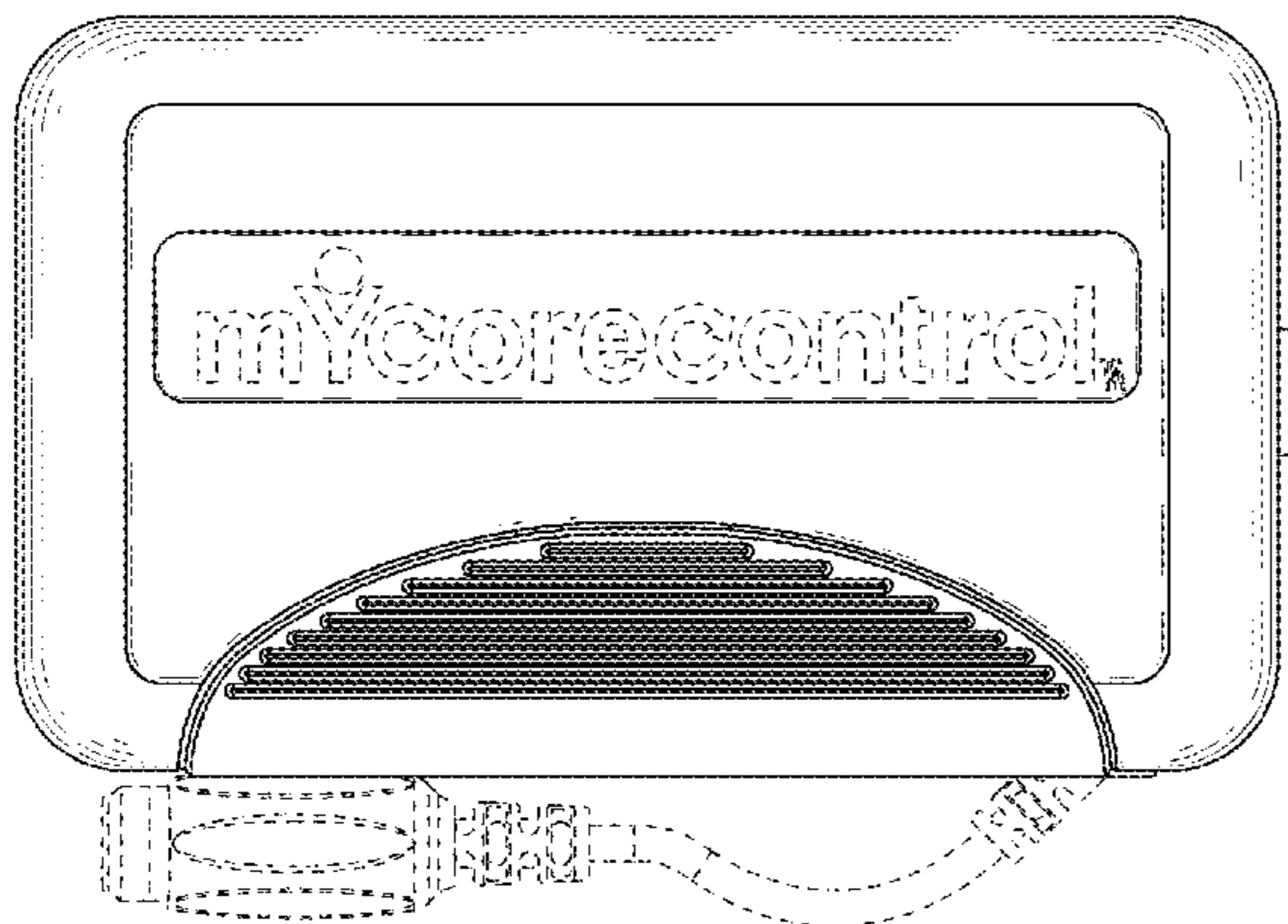

US D767,509 S

Page 2

(56)

References Cited

U.S. PATENT DOCUMENTS

2014/0210755 A1*	7/2014	Jung	G06F 3/01 345/173
2015/0138070 A1*	5/2015	Iwatsu	G02B 27/017 345/156
2015/0234189 A1*	8/2015	Lyons	G02B 27/0172 345/174
2015/0235435 A1*	8/2015	Miller	G06T 19/006 345/633
2016/0033770 A1*	2/2016	Fujimaki	G06T 19/006 345/8
2016/0035136 A1*	2/2016	Sendai	G02B 27/0172 345/633
2016/0078686 A1*	3/2016	Kimura	G06F 3/01 345/633

* cited by examiner

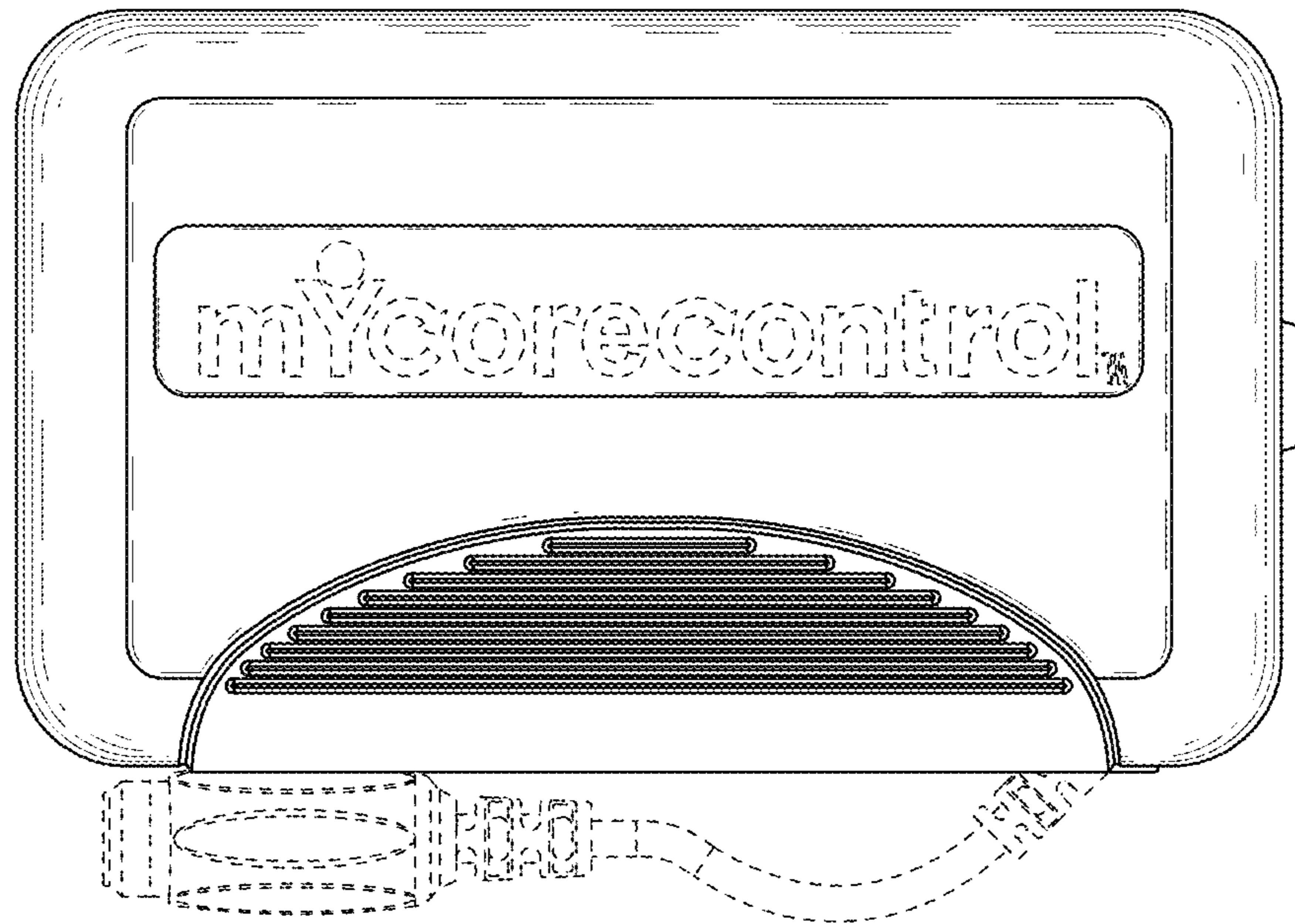

FIG. 1

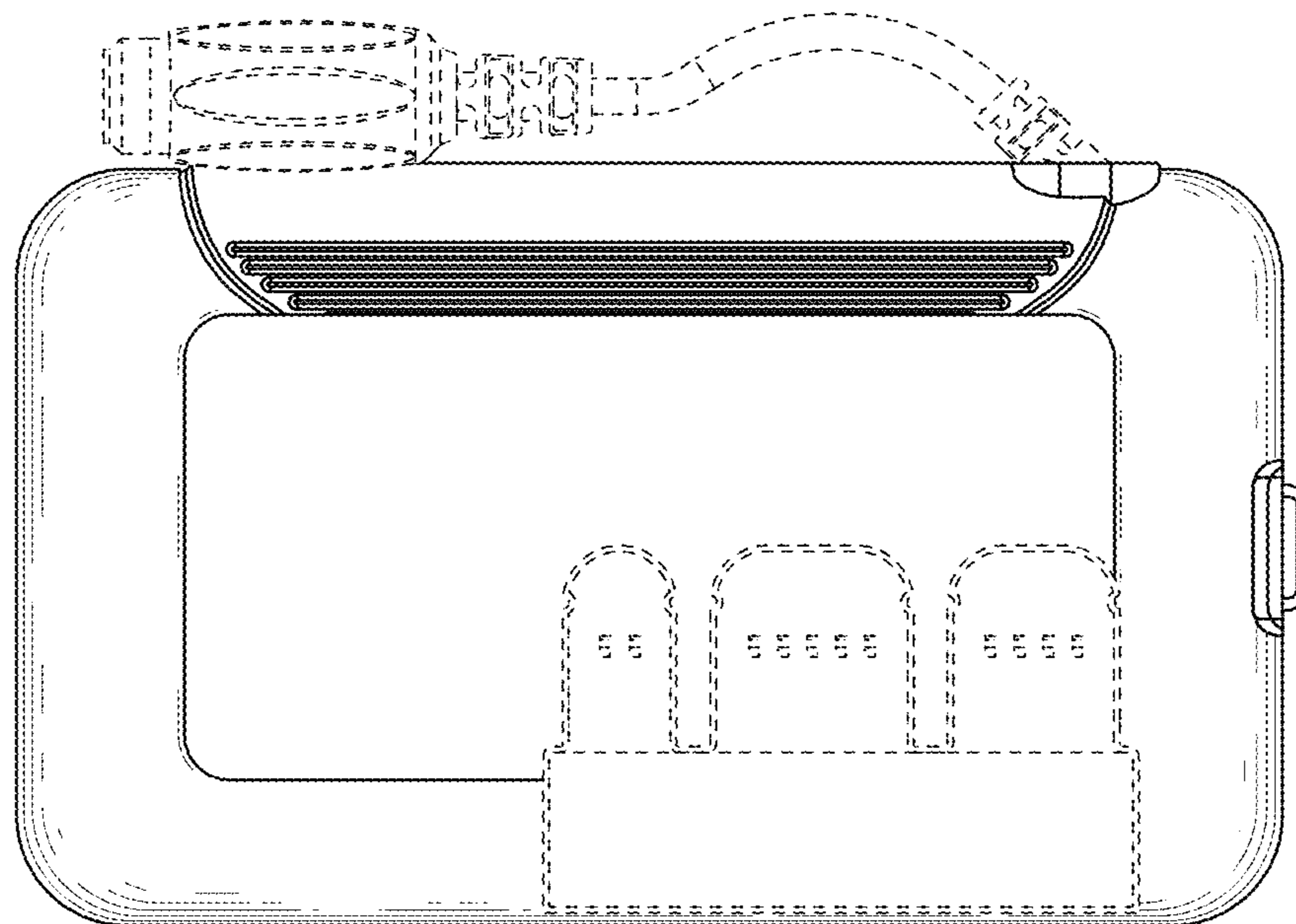

FIG. 2

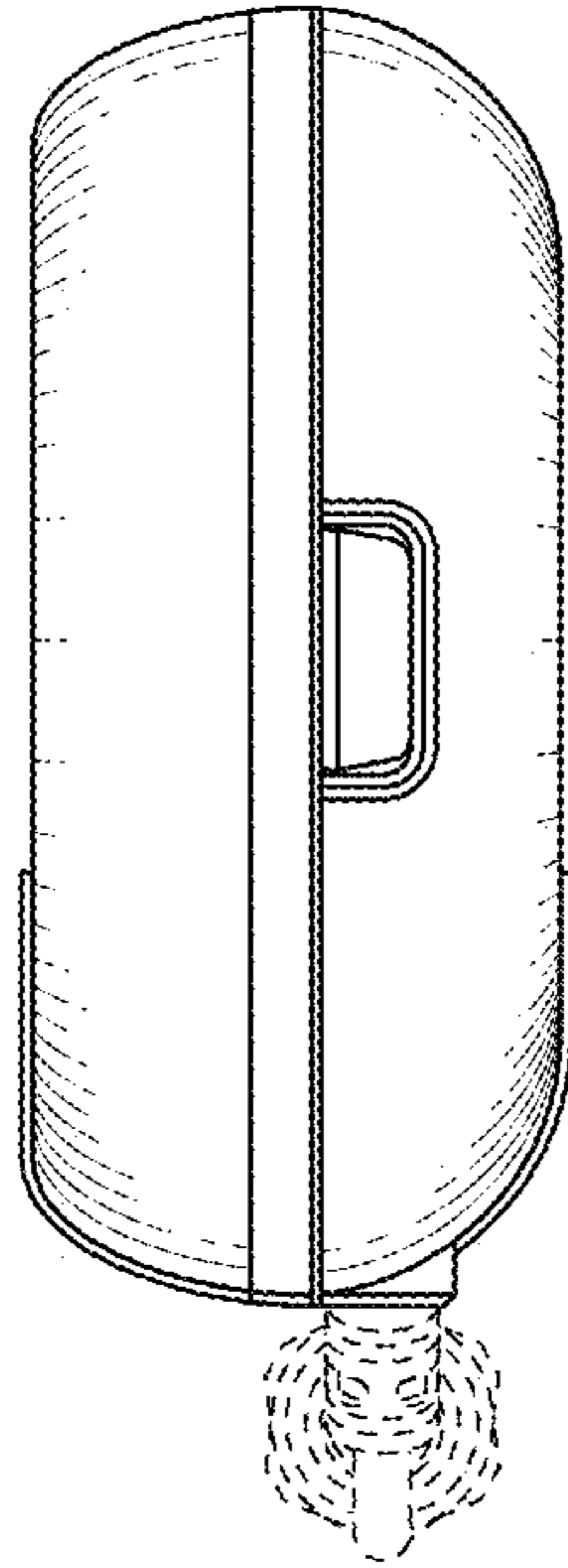

FIG. 3

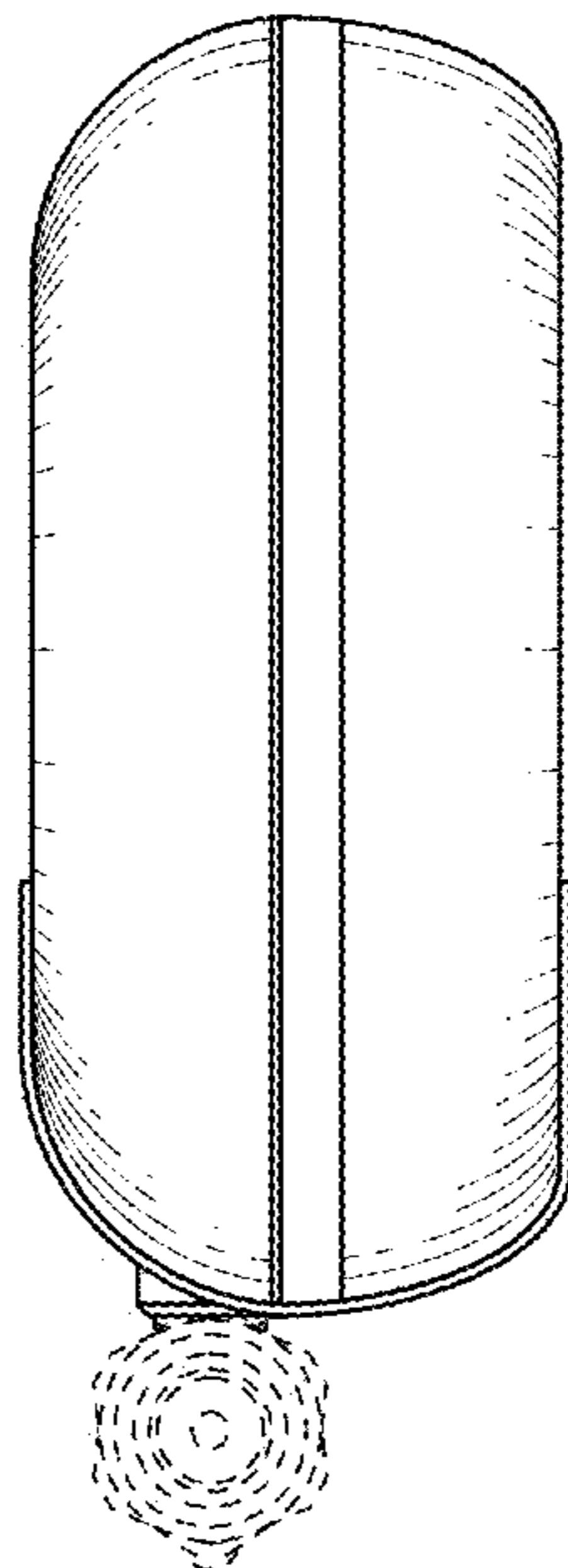

FIG. 4

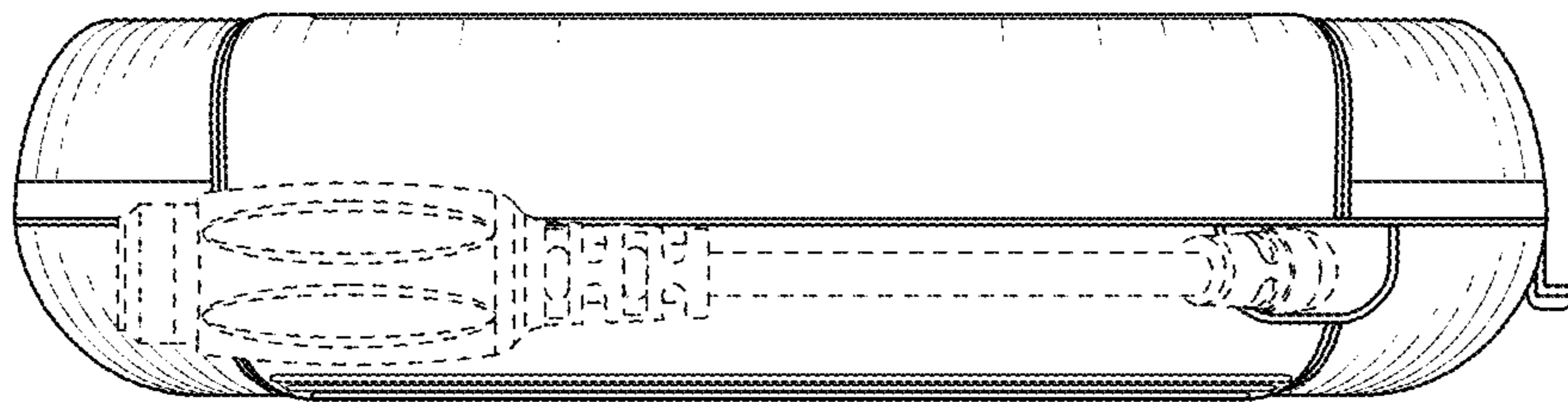

FIG. 5



FIG. 6

UNITED STATES PATENT AND TRADEMARK OFFICE
CERTIFICATE OF CORRECTION

PATENT NO. : D767,509 S
APPLICATION NO. : 29/515123
DATED : September 27, 2016
INVENTOR(S) : Lavin, Jr.

Page 1 of 1

It is certified that error appears in the above-identified patent and that said Letters Patent is hereby corrected as shown below:

On the Title Page

At Item (72) inventor's name be corrected from "Edwin F. Lavin, Jr." to "Edward F. Lavin, Jr."

Signed and Sealed this
Fourteenth Day of August, 2018



Andrei Iancu
Director of the United States Patent and Trademark Office